

ADVANCED HEAT-TRACING CONTROL SYSTEM

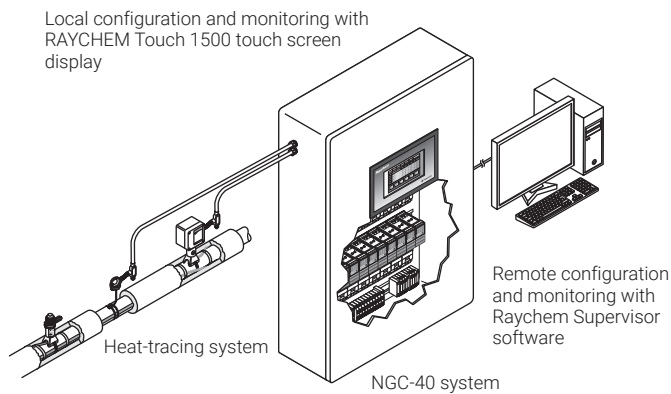

PRODUCT OVERVIEW

The nVent RAYCHEM NGC-40 is a multipoint electronic control, monitoring and power distribution system with a unique single-point controller architecture for heat-tracing used in process temperature maintenance and freeze protection applications. By taking advantage of innovative modular packaging techniques, the RAYCHEM NGC-40 system provides configuration and component flexibility so that it may be optimized for a customer's specific needs.

The RAYCHEM NGC-40 uses a single controller module per heat-tracing circuit for maximum reliability. The RAYCHEM NGC-40 control system can be powered between 100 to 240 Vac, while mechanical contactors (EMRs) or solid-state relays (SSRs) allow circuit switching up to 60 A at 600 Vac with single- or three-phase power. The RAYCHEM NGC-40 control modules include ground-fault detection and protection and eliminate the need for external GF circuit breakers, thus reducing the overall cost of the Heat Management System. The control modules also guarantee precise single-phase and three-phase line current measurements.

Up to eight (8) Resistance Temperature Detectors (RTDs) can be used for each heat-tracing circuit allowing a variety of temperature control, monitoring, and alarming configurations. The NGC-40 System accommodates RTD inputs from a variety of sources. In addition to hardwiring an RTD directly into a Heat Trace Control module, RTDs can be wired to Input/Output modules (IO Module) within the panel or Remote Monitoring Modules (RMM2) in the field and assigned to heat tracing circuits through software. This means that a RAYCHEM NGC-40 system can be optimized for the specific needs of an application or customer.

Each IO module accepts up to four additional RTD inputs. Each RMM2 module installed in the field can accept up to 8 RTDs. 16 RMM2 Modules can be daisy chained together via RS-485 for a total of 128 (8x16) RTDs. Since multiple RMM2's can be networked over a single cable to the RAYCHEM NGC-40, the cost of RTD field wiring will be significantly reduced.

The RAYCHEM NGC-40 system supports multiple communications ports, allowing serial interfaces (RS-485 and RS-232) and network connections (Ethernet) to be used with external devices. All communications with the NGC-40 panel are accomplished through the NGC-40-BRIDGE module which acts as the central router for the system, connecting the panel's control modules, IO modules, RAYCHEM Touch 1500 touch screen and Remote Monitoring Modules (RMM2), as well as upstream devices such as RAYCHEM Supervisor and Distributed Control System (DCS). Communications to devices external to the NGC-40 panel are done using the Modbus® protocol over Ethernet, RS-485 or RS-232.

The RAYCHEM NGC-40 system provides both alarm outputs and digital inputs. The alarm output can be used to control an external annunciator. The digital input is programmable and may be used for various functions such as forcing outputs on and off or generating alarms, making the system more flexible to match each customer's specific needs.

Systems can be configured for nonhazardous and hazardous locations. The ability to monitor and configure the controller is available both locally and remotely with RAYCHEM Touch 1500 touch screen and the RAYCHEM Supervisor software.

RAYCHEM Touch 1500 local control and monitoring

The RAYCHEM NGC-40 system is configured with a user interface, RAYCHEM Touch 1500, that is a state-of-the-art 15-inch (381 mm) color display with touch screen technology. The RAYCHEM Touch 1500 touch screen allows convenient user access on site to all heat-tracing circuits and provides an easy user interface for programming without using keyboards. The RAYCHEM Touch 1500 can be installed either locally on the panel door (hazardous or nonhazardous location) or in a remote location and communicates to the RAYCHEM NGC-40 heat-tracing controllers via Ethernet or serial interface. In case of outdoor location, a window cover and a heater/cooler may be required.

The RAYCHEM Touch 1500 can be used for configuration and monitoring of all heat-tracing circuits. The software is multilingual, offers 4 levels of integrated security and records alarms and events for maintenance purposes.

RAYCHEM Supervisor software central control and monitoring

The RAYCHEM Supervisor software package provides a remote, graphic interface for the RAYCHEM NGC-40. The software allows the user to configure and monitor various NGC systems from a central location. It also provides an audible alarm tone, acknowledge and clear alarms; and contains advanced features such as data logging, trending, implement changes in batches, and other useful functions. Users can access all information from anywhere in the world, making RAYCHEM Supervisor a powerful management tool for the entire Heat Management System.

Control

The RAYCHEM NGC-40 measures temperatures with 3-wire, 100-ohm platinum RTDs, 2 or 3-wire, 100-ohm nickel iron RTDs, or 2-wire, 100-ohm nickel RTDs. The temperature information may come from a single, direct RTD hard-wired to the NGC-40 control panel, from a local NGC-40 IO module, or from a remote source such as an RMM2 module.

With EMRs the RAYCHEM NGC-40 can be configured for the following control modes:

- On/Off EMR
- PASC EMR
- Always On
- Always Off

PASC= Proportional Ambient Sensing Control

With SSRs, the panel can be configured for the following control modes:

- Proportional
- On/Off SSR
- PASC SSR
- Always On
- Always Off

The RAYCHEM NGC-40 also supports load-shedding. This mode overrides temperature control and forces the output of the control module off. The load-shedding command can be issued by Distributed Control System (DCS) or RAYCHEM Supervisor.

Monitoring

The RAYCHEM NGC-40 system measures a variety of parameters including ground-fault, temperature and load current(s) to ensure system integrity. In the case of three-phase heaters, the current of each phase can be separately measured and monitored. The system can be set to periodically check the heating cable for faults, alerting maintenance personnel of a pending heat-tracing problem.

All alarms can be individually enabled or disabled depending on customer preference. They can be also separately defined as latching or non-latching by the customer to meet their needs. The latching alarms need to be reset before they disappear from the alarm list.

A dry contact relay is available for alarm annunciation back to a Distributed Control System (DCS). Alternatively, the RAYCHEM NGC-40 system can report alarm and monitoring data directly to the DCS via Modbus.

Ground-fault protection

National electrical codes require ground-fault equipment protection on all heat tracing circuits. Heat-tracing circuits equipped with RAYCHEM NGC-40 control modules do not require additional ground-fault detection equipment, thus simplifying installation and reducing costs.

Installation and communications

The RAYCHEM NGC-40 system can be networked to a host PC running Windows®-based RAYCHEM Supervisor client-server software and/or to a User Interface touch screen display (Touch 1500) for central programming, status review, and alarm annunciation.

Information access for external devices is through the NGC-40-BRIDGE communications module, which supports the Modbus protocol and is available with RS-232/RS-485 and 10/100Base-T Ethernet communication interfaces.











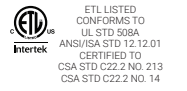

Packaging

RAYCHEM NGC-40 is designed for easy installation and requires minimal wiring on site. All NGC-40 units are packaged in DIN rail mount housings, suitable for installation onto symmetric 35 mm DIN rails.

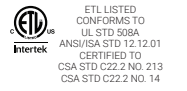
Complete system

The RAYCHEM NGC-40 is supplied as a complete system, ready for field connections to power wiring and temperature sensor input. Optional Power Distribution provides further enhancement reducing field wiring and installation labor.

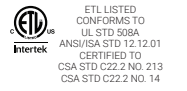
GENERAL

Area of use	<p>NGC-40 EMR for nonhazardous locations NGC-40 EMR with Z purge for hazardous locations NGC-40 SSR for hazardous locations Class I, Division 2, Groups A-D Class I, Zone 2, Group IIC -13°F to 140°F (-25°C to 60°C) Temperature Rating: T4</p>						
Approvals	<table border="0" style="width: 100%;"> <tr> <td style="text-align: center; vertical-align: top;"> <p>Nonhazardous Locations</p>  </td> <td style="text-align: center; vertical-align: top;"> <p>Hazardous Locations (EMR purged version)</p>  </td> <td style="text-align: center; vertical-align: top;"> <p>Hazardous Locations (SSR version)</p>  </td> </tr> <tr> <td colspan="3" style="text-align: center; vertical-align: top;">  </td> </tr> </table>	<p>Nonhazardous Locations</p> 	<p>Hazardous Locations (EMR purged version)</p> 	<p>Hazardous Locations (SSR version)</p> 			
<p>Nonhazardous Locations</p> 	<p>Hazardous Locations (EMR purged version)</p> 	<p>Hazardous Locations (SSR version)</p> 					
							
Heater cable power	120–600 Vac, 50/60 Hz, 60 A						
Supply voltage	100–240 Vac, +5% / -10%, 50/60 Hz						
Internal Power Consumption	< 2.4 W per NGC-40-HTC/HTC3 module						

ENCLOSURE

Protection/materials	Enclosure	Type area classification	Usage
	Type 12	Nonhazardous (Unclassified)	Locations indoors
	Type 4X/3R	Nonhazardous (Unclassified) Locations	Outdoors, stainless/painted steel
	Type 4X/3R with Z purge option	Hazardous Locations <ul style="list-style-type: none"> • Class I, Division 2, Groups A, B, C, D • Class I, Zone 2, Group IIC 	Outdoors, stainless/painted steel with mechanical relays
	Type 4X/3R	Hazardous Locations <ul style="list-style-type: none"> • Class I, Division 2, Groups A, B, C, D • Class I, Zone 2, Group IIC 	Outdoors, stainless/painted steel with solid-state relays

ENVIRONMENTAL

Operating temperature

Without distribution	–40°F to 140°F (–40°C to 60°C) Space heater and thermostat must be used if below –13°F (–25°C)
With distribution	14°F to 140°F (–10°C to 60°C) Space heater and thermostat must be used if below 14°F (–10°C)
With Installed Touch 1500 / Touch 1500-HAZ	32°F to 122°F (0°C to 50°C) Window cover, space heater and thermostat must be used if below 32°F 0°C)

Storage temperature

Without distribution	–40°F to 140°F (–40°C to 60°C)
With distribution	–13°F to 167°F (–25°C to 75°C)
With Installed Touch 1500 / Touch 1500-HAZ	–4°F to 140°F (–20°C to 60°C)

CONTROL HARDWARE

Relay types

- Electromechanical, (EMR versions):
Poles: 3-pole
Amperage: 30 A, 60 A
- Solid-state relays (SSR versions):
Poles: 1-, 2-, or 3-pole
Amperage: 30 A, 60 A

PROGRAMMING AND SETTING

Method	The ability to program the controller is available both locally and remotely with RAYCHEM Touch 1500 touch screen and the RAYCHEM Supervisor software via Modbus communications.												
Units	°F or °C												
Memory	Nonvolatile, restored after power loss												
Reset switch	Recessed hardware reset pushbutton on front of module. (HTC, HTC3, I/O and bridge modules)												
Stored parameters (measured)	Minimum and maximum temperatures, contactor cycle count, heater time in use												
Temperature set point range	-112°F to 1292°F (-80°C to 700°C)												
Deadband	1°F to 90°F (1°C to 50°C) in On/Off control												
Alarm conditions	<ul style="list-style-type: none"> • Low/high temperature • High temperature limit cutout • Low/high current • Over current trip • Ground-fault alarm and trip • Contactor cycle count • Switch limiting • Total time heater energized • Controller reset • RTD failure • Communications failure • Relay failure (covers both SSR/EMR) • Current transformer failure • External input source failure • Load shed source failure • User configuration data lost • Factory configuration data lost 												
Monitoring modes	<ul style="list-style-type: none"> • Temperature • Current • Ground Fault 												
Control modes	<p>User selectable for each circuit:</p> <table border="0" style="margin-left: 20px;"> <thead> <tr> <th style="text-align: left;">EMR</th> <th style="text-align: left;">SSR</th> </tr> </thead> <tbody> <tr> <td>On/Off EMR</td> <td>Proportional</td> </tr> <tr> <td>PASC EMR</td> <td>On/Off SSR</td> </tr> <tr> <td>Always On</td> <td>PASC SSR</td> </tr> <tr> <td>Always Off</td> <td>Always On</td> </tr> <tr> <td></td> <td>Always Off</td> </tr> </tbody> </table> <p>PASC= Proportional Ambient Sensing Control</p>	EMR	SSR	On/Off EMR	Proportional	PASC EMR	On/Off SSR	Always On	PASC SSR	Always Off	Always On		Always Off
EMR	SSR												
On/Off EMR	Proportional												
PASC EMR	On/Off SSR												
Always On	PASC SSR												
Always Off	Always On												
	Always Off												

ANALOG AND DIGITAL SIGNAL INPUTS

Ambient or pipe sensors	<ul style="list-style-type: none"> • One RTD per control point directly connected to each NGC-40-HTC/HTC3 for up to 80 directly connected RTD inputs via NGC-40-HTC/HTC3 • Up to 7 additional RTDs can be assigned to one HTC/HTC3 via the optional NGC-40-IO, or another HTC/HTC3, or RMM2 modules
Additional temperature sensor inputs (optional)	<ul style="list-style-type: none"> • Each NGC-40-IO module installed in the panel can accept up to 4 RTDs • Each RMM2 module installed in the field can accept up to 8 RTD's. 16 RMM2 modules can be daisy chained together via RS-485 for the total of 128 (8x16) RTDs
Temperatures sensor types	<ul style="list-style-type: none"> • 100 Ω platinum RTD, 3-wire, $\alpha = 0.00385$ ohms/ohm/°C Can be extended with a 3-conductor shielded cable of 20 Ω maximum per conductor • 100 Ω nickel iron RTD, 2 or 3-wire, $\alpha = 0.00518$ ohms/ohm/°C Can be extended with a 2-conductor shielded cable of 20 Ω maximum per conductor • 100 Ω nickel RTD, 2-wire, $\alpha = 0.00518$ ohms/ohm/°C Can be extended with a 2-conductor shielded cable of 20 Ω maximum per conductor <p>(Note: Power wire and RTD wire should not be housed in the same conduit.)</p>
Digital input	Each HTC, HTC3, and I/O module provides one multi-purpose digital input for connection to external dry (voltage-free) contact or DC voltage. Digital Input is programmable. It can be configured to be active open or active closed.
Alarm output	Each HTC, HTC3 and I/O module has a dry contact alarm output relay. Relay contact rated 250 Vac / 3 A 50/60 Hz (CE) and 277 Vac / 3 A 50/60 Hz (cCSAus). Alarm relay is programmable. NO and NC contacts available.
Relay output	One Form C relay rated at 12 A @ 250 Vac. Relay is used as a common system alarm. Relay may be assigned for alarm output.

CONNECTION TERMINALS

Heating cable output	Screw terminals, 20–6 AWG (30 A and 60 A versions)
Internal ground	14–4 AWG ground bar
Wiring terminals (RTD)	Spring clamp, 28–12 AWG
Wiring terminals (Relay/alarm/communications)	Spring clamp, 28–10 AWG
Module networking and module power	(2) RJ-45s, one each IN and OUT Provides CAN bus signals and +24 Vdc power

MONITORING RANGES

Temperature	Low alarm range	–112°F to +1292°F (–80°C to +700°C) or OFF
	High alarm range	–112°F to +1292°F (–80°C to +700°C) or OFF
Ground fault	Alarm range	10 mA to 250 mA
	Trip range	10 mA to 250 mA or OFF
Current	Low alarm range	0.3 A to 60.0 A
	High alarm range	0.3 A to 60.0 A
Autocycle	Each circuit can be programmed from 1 to 750 hours or OFF	

MOUNTING

Panel mounting on 35 mm DIN rails	FE connection from module housing to DIN rail
-----------------------------------	---

INTERNAL NETWORKING PORT

Type	2-wire isolated CAN-based peer-peer network. Isolated to 300 Vac
Connection	(2) 8-pin RJ-45 connectors (both may be used for Input or Output connections)
Protocol	Proprietary NGC-40
Topology	Daisychain
Length	10 m max.
Quantity	A maximum of 80 CAN nodes per network segment
Address	Unique, Factory assigned

DISTRIBUTION (FOR RAYCHEM NGC-40-EMR ONLY)

Load power	120 / 208 / 240 / 277 / 347 / 480 / 600 Vac
Field wire size	14–8 AWG (15–30 Amp C.B.), 8–4 AWG (40–50 Amp C.B.)
Circuit breaker amperage rating	120 Vac 20 A, 30 A, 40 A, 50 A 208, 240, 277, 347, 480, 600 Vac 20 A, 30 A, 40 A, 50 A, 60 A
Main contactor	3-pole

RAYCHEM TOUCH 1500 – USER INTERFACE TOUCH SCREEN

Touch 1500

15-inch color touch screen display
kit – touchscreen and Relay Output
Module, panel mounting

Area Classification:
Usage:

Nonhazardous (Unclassified) locations
Type 4 (IP 65),
Indoors or outdoors (with optional space heaters and window
shield)

Touch 1500R

15-inch color touch screen display
kit – touch screen and Relay Output
Module, remote, stand-alone mounting

Area Classification:
Usage:

Nonhazardous (Unclassified) locations
Type 4 (IP 65), Indoors

Touch 1500-HAZ

15-inch color touch screen display
kit – touchscreen and Relay Output
Module, panel mounting

Area Classification:
Usage:

Hazardous locations
Type 4 (IP 65),
Indoors or outdoors (with optional space heaters and window
shield)

A typical RAYCHEM NGC-40 consists of at least one Power and Termination module (NGC-40-PTM), one Bridge module (NGC-40-BRIDGE), one or more Heat Trace Controllers (NGC-40-HTC or HTC3) and one or more IO modules (NGC-40-IO). RMM2 modules and/or Touch 1500 touch screen unit may also be optionally used.

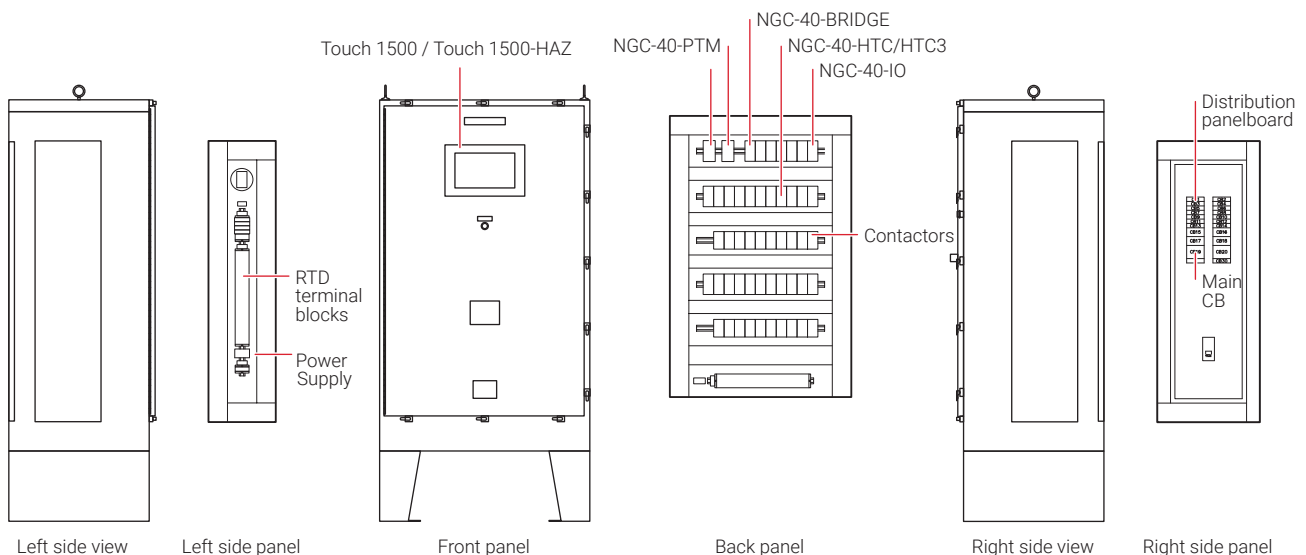

NGC-40 PANEL SIZES

EMR Panels		
Number of control points	Panelboard size	NGC-40 panel size
5	None	36" H x 36" W x 16" D
5	12 space	48" H x 36" W x 16" D
5	18 space	48" H x 36" W x 16" D
10	None	48" H x 36" W x 16" D
10	18 space	48" H x 36" W x 16" D
10	20 space	48" H x 36" W x 16" D
10	24 space	48" H x 36" W x 16" D
10	30 space	60" H x 36" W x 16" D
10	42 space	72" H x 36" W x 24" D
20	None	72" H x 36" W x 24" D
20	30 space	78" H x 36" W x 24" D
20	42 space	78" H x 36" W x 24" D
30	None	84" H x 36" W x 24" D
30	42 space	84" H x 36" W x 24" D
40	None	88" H x 36" W x 24" D
40	42 space	88" H x 36" W x 24" D
SSR Panels		
Number of control points	NGC-40 panel size	
5	36" H x 30" W x 16" D	
10	48" H x 36" W x 16" D	
20	72" H x 36" W x 24" D	
30	84" H x 36" W x 24" D	
40	88" H x 36" W x 24" D	

REPLACEMENT COMPONENTS

Description	Catalog number	Part number
NGC-40 Module		
Heat Tracing Control and Monitoring Module (Single-phase Heater)	NGC-40-HTC	10730-003
Heat Tracing Control and Monitoring Module (Three-phase Heater)	NGC-40-HTC3	10730-004
Input and Output Module	NGC-40-IO	10730-001
Communications Bridge Module	NGC-40-BRIDGE	10730-002
Power Termination Module	NGC-40-PTM	10730-005
Touch 1500 Touch Screen		
Touch 1500: 15-inch color touch screen display kit – touch screen and Relay Output Module, panel mounting, IP 65 (Type 4), nonhazardous (unclassified) locations, indoors or outdoors (with optional space heaters and window shield)	Touch 1500	10332-009
Touch 1500R: 15-inch color touch screen display kit – remote touch screen and Relay Output Module, stand-alone mounting, IP 65 (Type 4), nonhazardous (Unclassified) locations, indoors	Touch 1500R	10332-020
Touch 1500-TS: 15-inch color touch screen display – touch screen only, panel mounting, IP 65 (Type 4), nonhazardous (unclassified) locations, indoors or outdoors (with optional space heaters and window shield)	Touch 1500-TS	10332-014
Touch 1500-HAZ-TS: 15-inch color touch screen display – touch screen display only, panel mounting, IP 65 (Type 4), hazardous locations, indoors or outdoors (with optional space heaters and window shield)	Touch 1500-HAZ-TS	10332-011
Touch 1500-HAZ-CPU: CPU for Touch 1500-HAZ-TS approved for use in hazardous locations	Touch 1500-HAZ-CPU	10332-010
Relay Output: Relay Output Module with Modbus for Touch 1500	Relay Output – Touch	10332-024
Remote Monitoring Module, no enclosure	RMM2	051778
Remote Monitoring Module, with Type 4X enclosure	RMM2-4X	523420

Control Modules (NGC-40-HTC, NGC-40-HTC3)

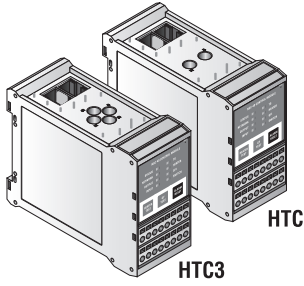

Two versions of this module are available: The NGC-40 Control module for single-phase heaters, NGC-40-HTC; the NGC-40 Control module for three-phase heaters, NGC-40-HTC3. Both versions use temperature data to control one single heat-tracing circuit by switching of Electromechanical relays (EMR) or Solid-State Relays (SSR). The NGC-40-HTC/HTC3 also provides ground-fault (leakage) current and line current sensing, monitoring and alarming.

One RTD can be directly connected to each HTC/HTC3 module for up to 80 directly connected RTD inputs. Up to 7 additional RTDs can be assigned to one HTC/HTC3 circuit via the optional NGC-40-IO or RMM2 modules.

A maximum of 81 NGC-40 modules (combination of Bridge, HTC, HTC3 and I/O modules) may be assembled in a single panel.

The NGC-40-HTC/HTC3 has one alarm relay output that can be connected to an external annunciator and one digital input that is programmable and may be used for various functions such as forcing the contactor or SSR on or off.

Input/Output Module (NGC-40-IO)

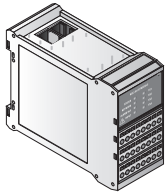

Each Input Output Module, NGC-40-IO, installed in the panel provides up to four (4) additional RTD inputs. These additional RTD inputs can be assigned to any NGC-40-HTC/HTC3 module. The NGC-40-IO module also provides one alarm relay that can be connected to an external annunciator and one digital input that is programmable and may be assigned to any NGC-40-HTC/HTC3 module for various functions such as forcing the contactor or SSR on or off.

Communications Bridge Module (NGC-40-BRIDGE)

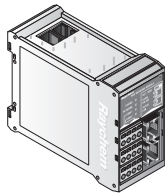

The NGC-40-BRIDGE module provides the interface between a panel's internal CAN-based network and upstream devices. Multiple communication ports are supported, allowing serial and Ethernet connections to be used with external devices: Each Bridge Module has two RS-485 ports, one RS-232 port and one 10/100Base-T Ethernet network with programmable communication parameters.

A maximum of 80 NGC-40 modules, a combination of HTC, HTC3 or I/O modules, can be connected to one NGC-40-BRIDGE module.

Power Termination Module (NGC-40-PTM)

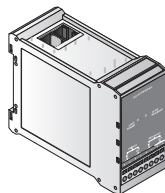

The NGC-40-PTM accepts a primary and redundant +24 Vdc power supply input and a space power to the NGC-40 module.

Each NGC-40-PTM can provide power to a maximum of 10 NGC-40 modules.

ADDITIONAL SYSTEM COMPONENTS (ORDERED SEPARATELY)

RAYCHEM Touch 1500 - User Interface Touch Screen

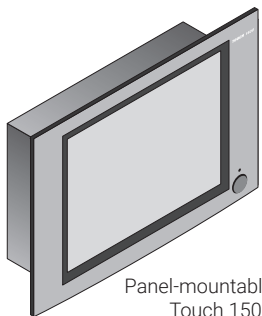

Panel-mountable
Touch 1500

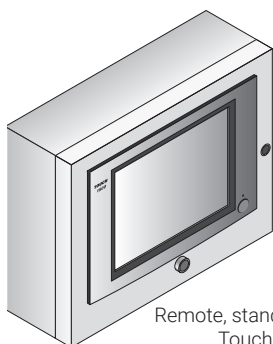

Remote, stand-alone
Touch 1500R

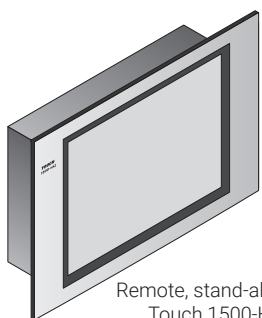

Remote, stand-alone
Touch 1500-HAZ

Remote Monitoring Module (RMM2)

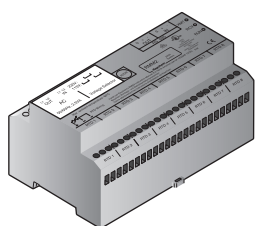

The RAYCHEM Touch 1500 user interface touch screens are easy-to-navigate displays, with intuitive screens for use with the NGC-40 control panel. The intent of the Touch 1500 is to be installed in the field where the physical heat-tracing hardware is located to assist with system commissioning, setup, troubleshooting and on-site monitoring and control. Each RAYCHEM Touch 1500 has a 15-inch LCD color display with touch-screen technology, and provides an easy user interface for programming without using keyboards. It has RS-485, RS-232, and 10/100Base-T Ethernet communications ports that allow communication with the Bridge Module (NGC-40-BRIDGE). A USB interface is included for easy configuration and software upgrades.

The RAYCHEM Touch 1500 User Interface Touch Screens are available in three options:

1) Touch 1500 – Panel Mountable User Interface Touch Screen

Designed for use in nonhazardous location installations, indoors or outdoors (with optional space heaters and window shield), this Touch 1500 is rated for Type 4 environments and installed on the external RAYCHEM NGC-40 panel door.

2) Touch 1500R – Remote Stand Alone User Interface Touch Screen

Designed for use in indoor, nonhazardous location installations, this remote Touch 1500R is a stand-alone display with Type 4 enclosure for use with the RAYCHEM NGC-40 panel.

3) Touch 1500-HAZ – Panel Mountable User Interface Touch Screen

Designed for use in hazardous location installations, indoors or outdoors (with optional space heaters and window shield), this Touch 1500-HAZ is rated for Type 4 environments and installed on the external RAYCHEM NGC-40 panel door.

A Remote Monitoring Module (RMM2) is used to collect temperatures for control and monitoring of the heat-tracing system by the RAYCHEM NGC-40 control panel. The RMM2 accepts up to 8 RTDs that measure pipe, vessel, or ambient temperatures. A single twisted-pair RS-485 cable connects up to 16 RMM2's for a total monitoring capability of 128 temperatures. The RMM2's are placed near desired measurement locations in nonhazardous or hazardous locations.

NGC-40 CONNECTION DIAGRAMS

One NGC-40 Panel Using RAYCHEM Supervisor Software

- Monitors ground-fault current and alarms/trip control contactor upon fault
- Monitors heating cable current and alarms upon low or high current conditions
- Monitors pipe temperature (via RTD inputs wired back to the RAYCHEM NGC-40) and alarms upon low or high temperature condition

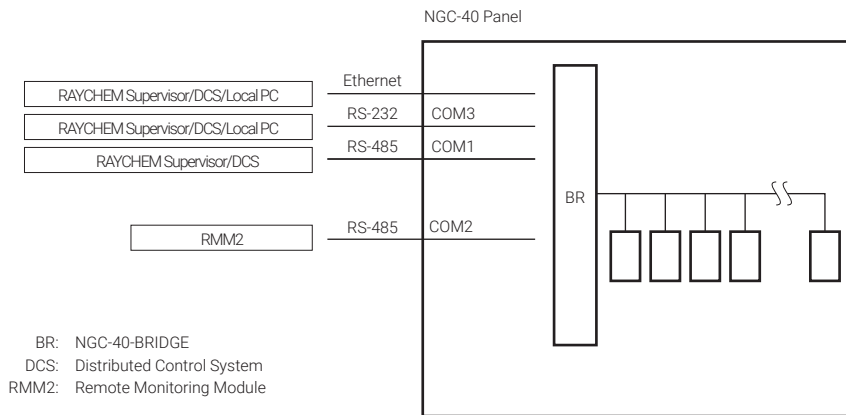
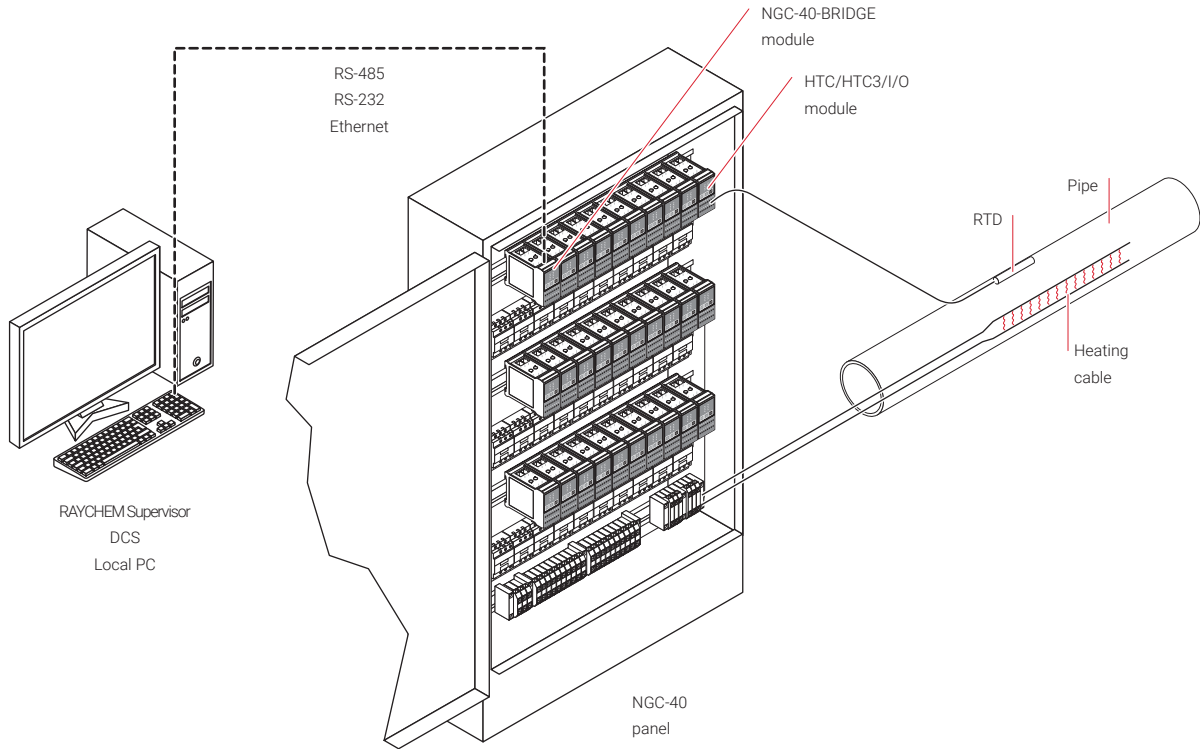

Multiple NGC-40 Panels Using RAYCHEM Supervisor Software

- Monitors ground-fault current and alarms/trip control contactor upon fault
- Monitors heating cable current and alarms upon low or high current conditions
- Monitors pipe temperature (via RTD inputs wired back to the RAYCHEM NGC-40) and alarms upon low or high temperature conditions

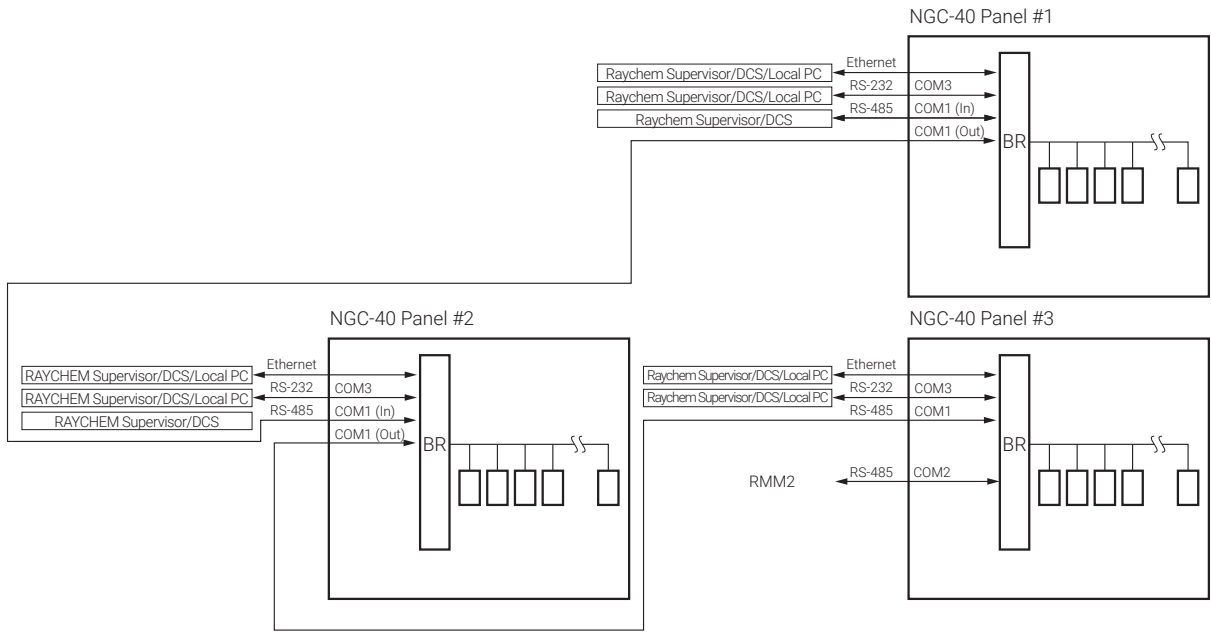
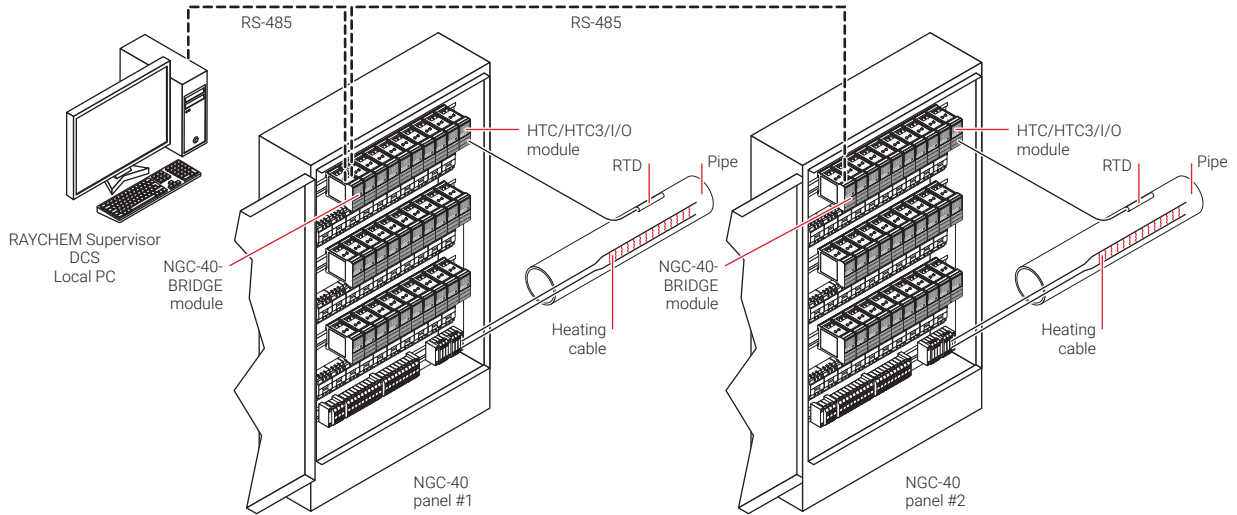

BR: NGC-40-BRIDGE
 DCS: Distributed Control System
 RMM2: Remote Monitoring Module

NGC-40 CONNECTION DIAGRAMS

One NGC-40 Panel Using One Touch 1500 Touch Screen and Optional RMM2 Module

- Monitors ground-fault current and alarms/trip control contactor upon fault
- Monitors heating cable current and alarms upon low or high current conditions
- Monitors pipe temperature (via RTD inputs wired back to the RAYCHEM NGC-40) and alarms upon low or high current conditions
- Using optional RMM2 (remote monitoring modules) mounted in the field, up to 128 additional RTD inputs can be added to the NGC-40 system
- The RMMs allow the RTD cables to be terminated locally and only a single RS-485 twisted wire pair brought back to the panel. This results in a significant reduction in field wiring.

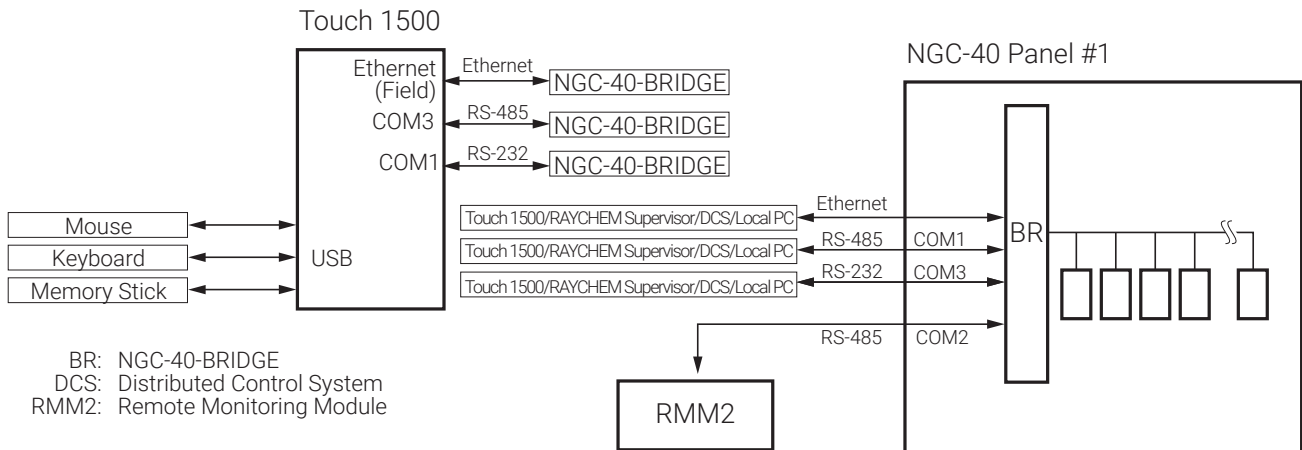
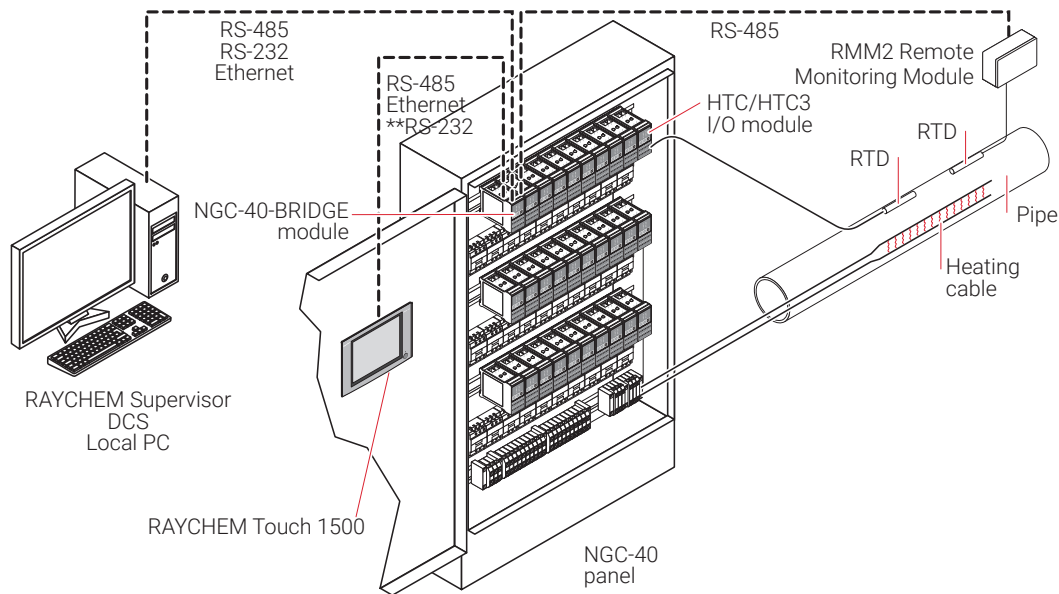

NGC-40 CONNECTION DIAGRAMS

Multiple NGC-40 Panels Using Common Touch 1500 Touch Screen and Optional RMM2 Module

- Monitors ground-fault current and alarms/trip control contactor upon fault
- Monitors heating cable current and alarms upon low or high current conditions
- Monitors pipe temperature (via RTD inputs wired back to the RAYCHEM NGC-40) and alarms upon low or high current conditions
- Using optional RMM2 (remote monitoring modules) mounted in the field, up to 128 additional RTD inputs can be added to the NGC-40 system
- The RMMs allow the RTD cables to be terminated locally and only a single RS-485 twisted wire pair brought back to the panel. This results in a significant reduction in field wiring.

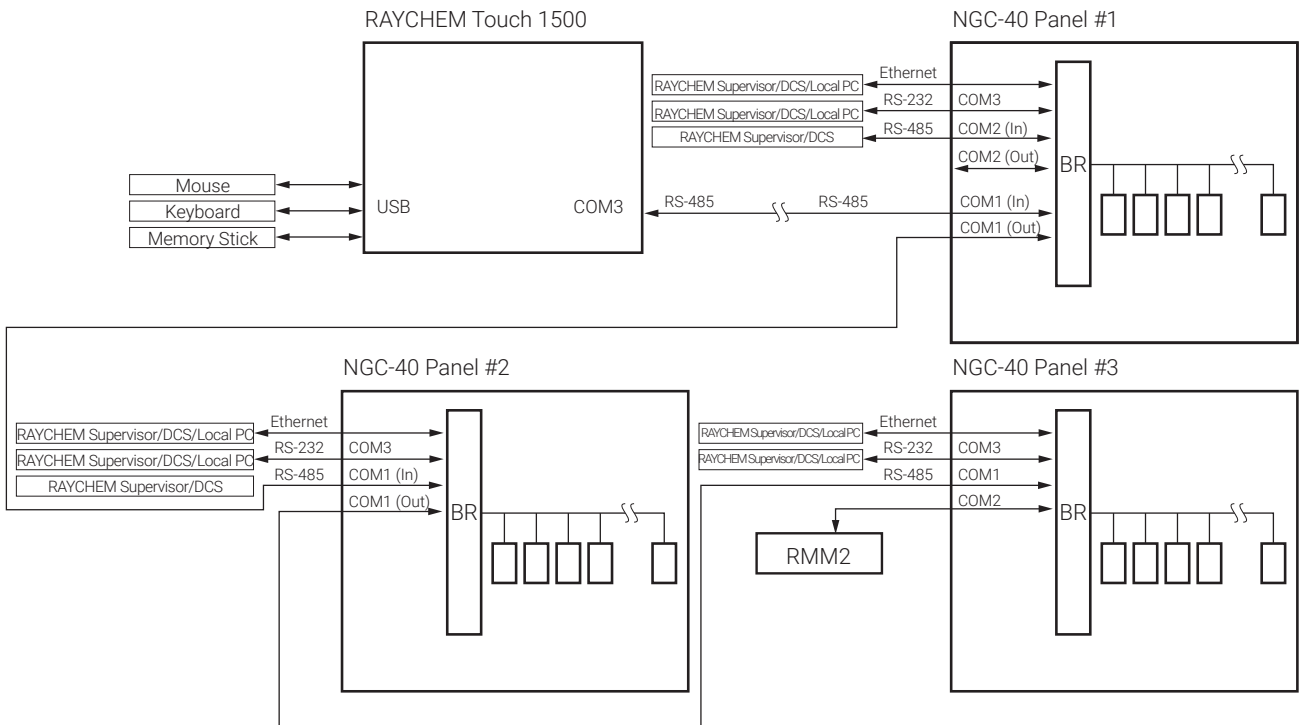
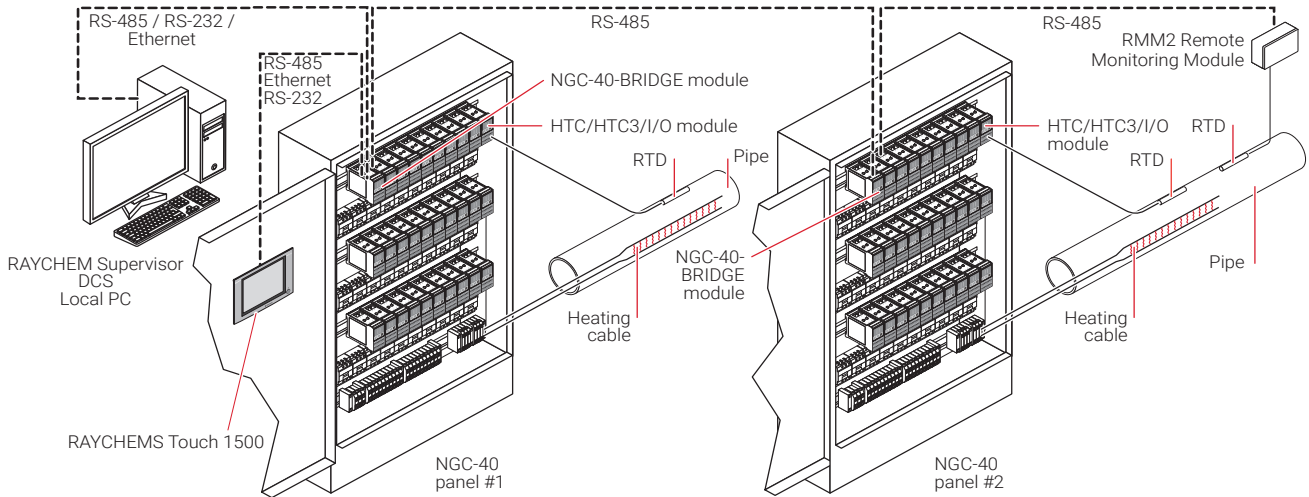

BR:NGC-40-BRIDGE
 DCS:Distributed Control System
 RMM2:Remote Monitoring Module

ORDERING DETAILS

NGC-40 – Output – No. of Control Points – No. of I/O Modules – Enclosure – Voltage – Panelboard Size – Breaker or SSR or EMR – MCB – Options

NGC-40 – XXX – XX (XXHTC, XXHTC3) – XX (IO) – XX – XXX/XXX – XX – XX/XX (XX) – XXX – XX

Output
EMR = Electro-mechanical relay
SSR = Solid-state relay

No. of control points
1 - 40

No. of modules (max 40 HTC/HTC3 modules)
XX (HTC) No. of single phase control modules
XX (HTC3) No. of three phase control modules
Note: The total quantity of HTC and HTC3 modules must be equal to the number of control points

No. of optional I/O modules
XX (IO)

Enclosure
12 = Type 12 (indoors; painted steel)
4 = Type 4/3R (outdoors; painted steel)
4X = Type 4X/3RX (outdoors; stainless steel)

Voltage
120 / 208 Vac
120 / 240 Vac¹
277 / 480 Vac
347 / 600 Vac

Panelboard
0 = none required

# of control points	Panelboard size			
	120/208 Vac	120/240 Vac	277/480 Vac	347/600 Vac
1-5	12	12	18	18
6-10	24	20/30	18/30	18/24
11-20	30/42	30/42	30/42	30/42
21-30	42	42	42	42
31-40	42	42	42	42

Example: NGC40-EMR without Panelboard for USA with one User Interface Unit (UIT)
NGC40-EMR-22(17HTC, 5HTC3), 5(IO)-12-277/480-0-17(30A), 5(60A)-0-US,U1

Example: NGC40-EMR with Panelboard and Z Purge for Canada
NGC40-EMR-22(17HTC, 5HTC3), 3(IO)-12-277/480-42-15/1P(30A), 2/2P(40A), 5/3P(60A)-125-CA, Z

Example: NGC40-SSR without Panelboard for South America
NGC40-SSR-22(17HTC, 5HTC3), 2(IO)-12-277/480-0-15/1P(30A), 2/2P(60A), 5/3P(60A)-0-US

¹ Single phase
² Special - Describe special requirement in detail
³ Applies to Canada only

Options
Country Installed
US = U.S. / South America [default]
CA = Canada
E = Environmental purge
H1 = Electric heater option for min. ambient from -20°C to 0°C (-4°F to 32°F)
H2 = Electric heater option for min. ambient below -20°C (-4°F)
R = Redundant power supply
TU0 = No Touch 1500 (Raychem Supervisor or remote Touch 1500R is required, Touch 1500R can be ordered separately)
TU1 = 1 Touch 1500 (nonhazardous)
TU2 = 1 Touch 1500-HAZ (hazardous)
X = Panel spare parts
Z = Z purge
SP = Special requirement²

Main circuit breaker
0 = none required (choose if no panelboard required)

Panelboard size	120/208 Vac	120/240 Vac	277/480 Vac	347/600 Vac
12	50, 100	50, 80, 100	-	-
18	-	-	30, 50, 70, 125	20, 40, 60, 90
20	-	50, 80, 100	-	-
24	50, 100	-	-	20, 40, 60, 90
30	50, 100, 150, 225	50, 80, 175, 225	50, 70, 125, 175, 225	40, 60, 90, 150, 200
42	50, 100, 150, 225	50, 80, 175, 225	50, 70, 125, 175, 225	40, 60, 90, 150, 200

Breaker or SSR or EMR Breaker

No. of control points	Max Number of Circuit Breakers (Number of Poles)									
	120 Vac (1P)	208 Vac (2P)	208 Vac (3P)	240 Vac (2P)	277 Vac (1P)	480 Vac (2P)	480 Vac (3P)	347 Vac (1P)	600 Vac (2P)	600 Vac (3P)
1-5	12	5	5	-	5	-	-	-	-	-
6-10	18	-	-	-	10	8	5	10	8	5
	20	10	-	9	-	-	-	-	-	-
	24	10	10	7	-	-	-	10	10	7
11-20	30	10	10	9	10	10	10	9	10	9
	42	10	10	10	10	10	10	10	10	10
	30	10	-	-	10	10	10	9	-	-
21-30	30	20	14	9	14	20	14	9	20	14
	42	20	20	13	20	20	20	13	20	13
31-40	42	30	20	13	20	30	20	13	30	13
31-40	42	40	20	13	20	40	20	13	40	20

Note: The quantity of breakers must be equal to the number of control points.
Note: The total number of C.B., EMR or SSR selected must be equal to selected control module capacity. (Consult factory for 2P SSR above 20 or 3P SSR above 13)

SSR without panelboard
Number of output devices (SSRs) / Number of poles (amperage)
Output devices: 1 - 40
Poles: 1P or 2P or 3P
Amperage: 30 A, 60 A

EMR without panelboard
Number of output devices (EMRs) (amperage)
Output devices: 1 - 40
Amperage: 30 A, 60 A

North America
Tel +1.800.545.6258
Fax +1.800.527.5703
thermal.info@nvent.com

Europe, Middle East, Africa
Tel +32.16.213.511
Fax +32.16.213.603
thermal.info@nvent.com

Asia Pacific
Tel +86.21.2412.1688
Fax +86.21.5426.3167
cn.thermal.info@nvent.com

Latin America
Tel +1.713.868.4800
Fax +1.713.868.2333
thermal.info@nvent.com



nVent.com

Our powerful portfolio of brands:

CADDY ERICO HOFFMAN RAYCHEM SCHROFF TRACER