



nVent SCHROFF Guardian Management Gateway

Product-No: 11079-000



**Read user manual**  
 The Guardian Management Gateway is intended to be installed and maintained by qualified and trained personnel in compliance with local and national electrical codes and safety regulations. Before initial operation, read the user manual.  
 You can find the manual at: <https://go.nvent.com/en-guardian-management-gateway.html>



**Safety instructions**  
 The Guardian Management Gateway must be operated only with the supplied AC adapter. The AC adapter is delivered without a power cable. Only use a power cable with a conductor that is approved in your country. Any interruption of the ground connection is prohibited.



**Attention!**

- o Use only nVent SCHROFF Guardian sensor modules and accessories
- o Do not connect an nVent SCHROFF Guardian sensor module to the Ethernet port
- o Do not connect the Management port to an Ethernet LAN
- o Use only 1:1 patch cables min. CAT 6 to connect sensor modules to the Guardian Management Gateway

**California Prop 65 Warning:** Cancer and Reproductive Harm – [www.P65Warnings.ca.gov](http://www.P65Warnings.ca.gov)

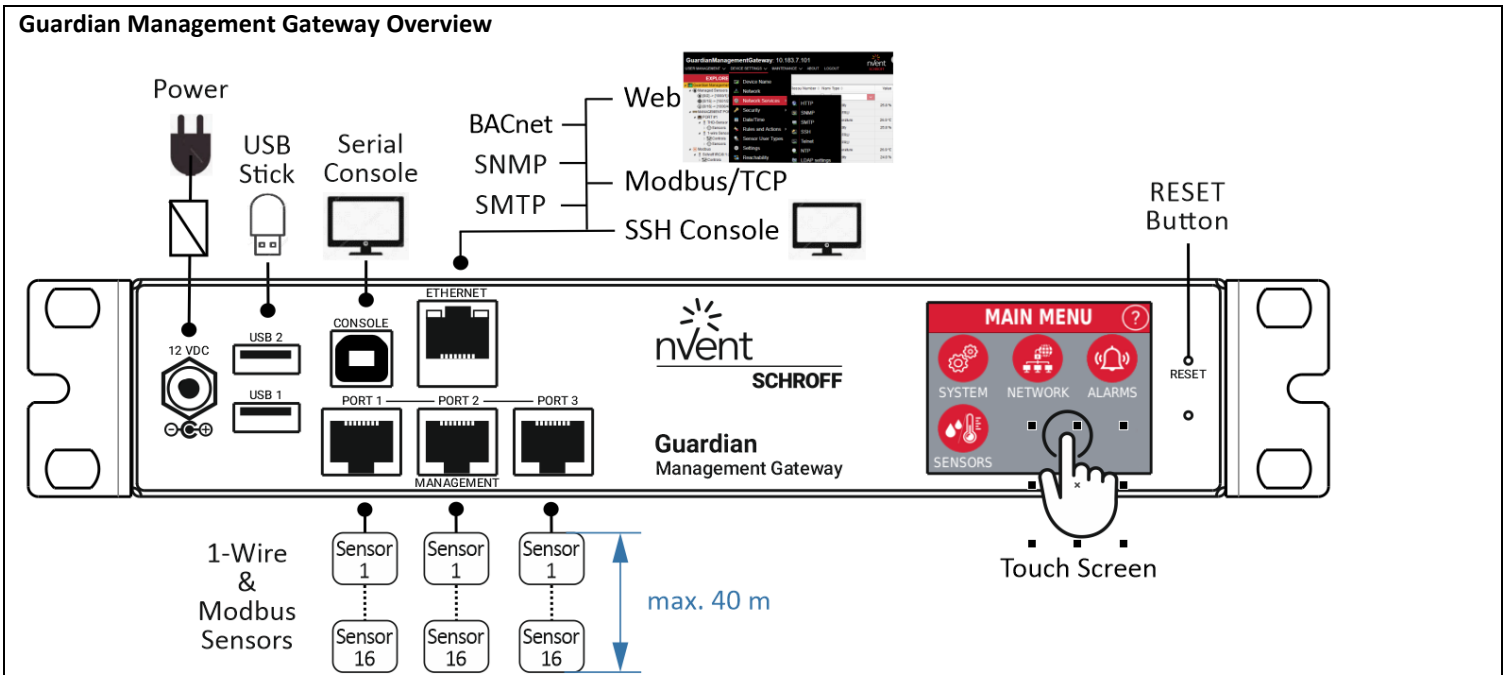

**External Sensors**



The Guardian Management Gateway offers three sensor management ports with each port is capable of monitoring up to 16 sensor devices with a total cable length of 40 meters per port.

**Info: Use only 1:1 patch cables min. CAT 6**

If an nVent SCHROFF Guardian sensor is connected, it appears with type and serial number in the web interface.

**Example sensor types:**

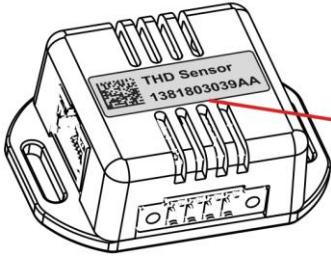
- (T) Temperature Sensor
- (TH) Multi Sensor (Temperature/Humidity)
- (THD) Multi Sensor (Temperature/Humidity/2x Digital Input)
- (D) Digital Sensor 1 (2x Digital Input)

The screenshot shows the 'GuardianManagementGateway' web interface. It displays a tree view under 'MANAGEMENT PORTS' for 'PORT #1', listing 'THD-Sensor 13818030039'. Below this, a list of sensors is shown: '[1000/1] Humidity', '[1000/2] Front Door Rac', and '[1000/3] Digital Input 2'.

## Initial Setup

- Use the supplied power adapter to connect the device to AC power.
- If the application requires connect functional ground to the back of the device.

## Connect the Management Gateway to a DHCP-enabled IPv4 network

- Retrieve the assigned IP address by pressing the NETWORK button on the touch screen.
- Use the CLI or the Web interface (https) to connect and start configuration.

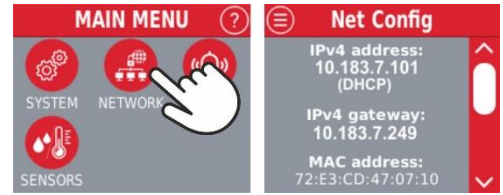

## Assign a static IP address

By default, the Management Gateway is configured to obtain its IPv4 address from a DHCP server. To assign a static IP address, complete the following steps:

- Connect your computer to the USB-B port labelled “CONSOLE” with an USB-A/USB-B cable.
- Determine COM port assigned by your computer to the USB Serial connection (Control Panel → System → Hardware → Device Manager → Ports > USB Serial Port).
- Open a terminal program (e.g. PuTTY), set Serial line to the assigned COM port (e.g. COM12), the Speed to 115200, and the Connection type to Serial
- Log in as “admin”
- Password: “admin”
- Assign the IPv4 configuration attributes for the network interface with CLI by entering the following command:  
`netconf ip <interface> <ip_address>/<mask> [<ipv4_gateway>]`
  - <interface> is the name of the adapter (eth0)
  - <ip\_address> is the IPv4 address assigned to the interface, in the decimal-dot notation
  - <mask> is the subnet mask as the number of significant bits; the address with mask may look like 10.183.7.110/24
  - <ipv4\_gateway> is the default gateway address in the decimal-dot notation, it's optional here.

Example:

```
netconf ip eth0 10.183.7.101/24 10.183.7.249
```

## Rack Mounting

The Guardian Management Gateway can be mounted in racks with 25 mm hole pattern frames. The mounting brackets can be fixed in 90 ° increments.

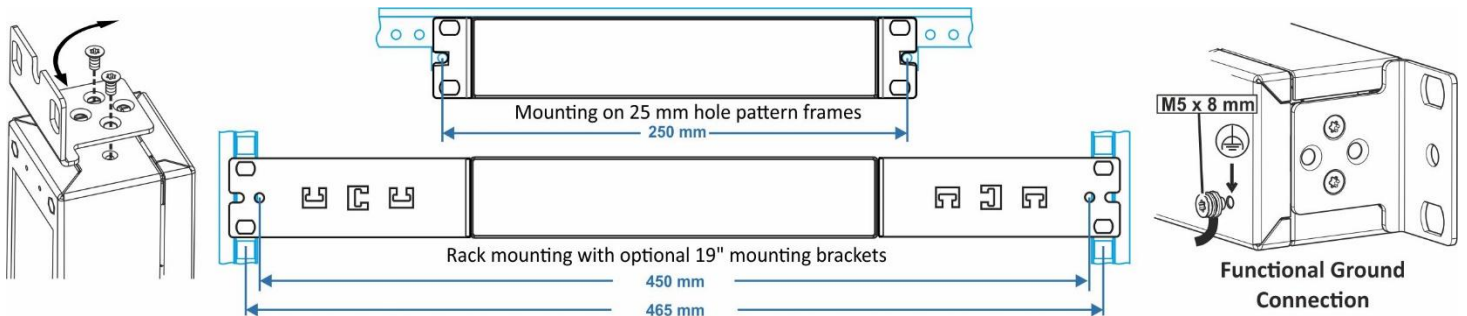

## Product Support

Additional product information, manuals, firmware and data sheets are available on the Schroff support website.

Visit: <https://go.nvent.com/en-guardian-management-gateway.html> or click on the nVent / Schroff logo at the web interface.

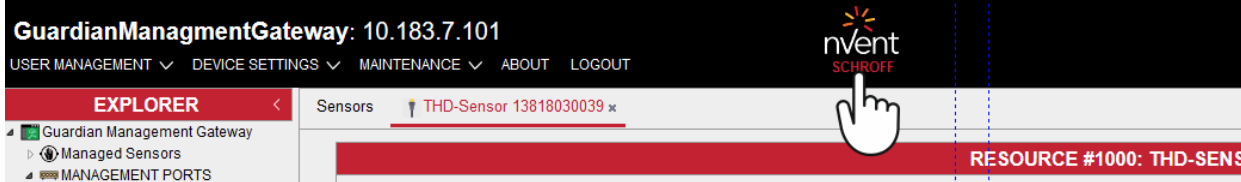

The devices described in this manual must be recycled. In accordance with the Directive 2012/19/EC on waste electronic and electrical equipment (WEEE), they may not be disposed of in the municipal waste disposal services. To ensure environmentally friendly recycling the devices can be returned to a locally approved disposal center. Make sure that you observe the regulations applicable in your country.