



We connect and protect

Electrical Connectors & Accessories

Making connections since 1894



nVent.com/ILSCO

Table of Contents



Compression



A Complete Line for Copper and Aluminum Conductors

- Lugs
- Taps
- Splices
- Custom Products

A

1 - 84



ILSCONS

For Copper and Aluminum Conductors

- nVent ILSCO Crimp 'N Seal
- Insulated and Non-Insulated Terminals
- nVent ILSCO Cool Seal

A1

85 - 126



Split Bolts

For Copper and Aluminum Conductors

- Split Bolts
- Two Bolt Clamps
- Labor Saving Alternative Products

B

127 - 140



Mechanical

A Complete Line for Copper and Aluminum Conductors

- Lugs
- Taps
- Splices
- Custom Products

C

141 - 208



Insulated Mechanical including nVent ILSCO Nimbus

- Multi-tap and splicer reducer connectors
- Broad wire range reduces inventory requirements
- Insulating covers eliminate need to tape

D

209 - 241



Insulation Piercing

Labor Saving Products

- Taps
- Splices

E

242 - 243

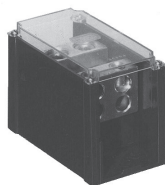

Power Distribution Blocks

- Modular Types
- One, Two and 3 Poles
- Custom Products

F

244 - 264



Grounding

- Overhead
- Underground
- Copper and Aluminum

G

265 - 314

Table of Contents



Flex Braid

- Manufactured from pure copper braid
- Electro-tin plated
- Seamless pure copper ferrules
- Inside ferrule ends are rounded
- Swaged terminal to copper braid by cold forming
- Extra flexible braided connector
- Rated for 600 volts

G1

315 - 317

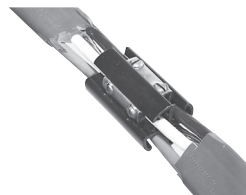

Direct Bury/ Underground

- Fully Insulated Watertight Products
- Direct Burial Products

H

318 - 337



Insulating Materials

- Heavy Wall Tubing
- Heavy Wall End Caps
- Medium Wall Tubing
- Thin Wall Tubing
- Wrap 'N Seal

I

338 - 345



Tools

- Compression Tools and Dies
- Mechanical Tools
- Strippers
- Cable Cutters

J

346 - 407



Specialty

- Oxide Inhibitor
- Duct Seal
- Neutral Bars

K

408 - 427

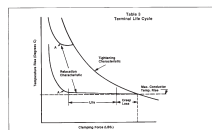

Technical Information

M

428 - 442

Pictorial Index

Compression

| | | | | | |
|--------------------------------------------------------------------------------------------------------------------------------------|----------------------------------------------------------------------------------------------------------------------|-----------------------------------------------------------------------------------------------------------------------------|----------------------------------------------------------------------------------------------------------------------|-----------------------------------------------------------------------------------------------------------------------|-----------------------------------------------------------------------------------------------------------------------|
| <p>CSWS</p>  <p>2 - 4</p> | <p>CSWD</p>  <p>5 - 10</p> | <p>CLWS</p>  <p>11 - 13</p> | <p>CLNS</p>  <p>14 - 16</p> | <p>CLWD</p>  <p>17 - 22</p> | <p>CLND</p>  <p>23 - 28</p> |
| <p>CLNF</p>  <p>29 - 30</p> | <p>CLNU</p>  <p>31</p> | <p>CSWN</p>  <p>32</p> | <p>CLWN</p>  <p>33</p> | <p>CSLT</p>  <p>34 - 35</p> | <p>CLWU</p>  <p>36</p> |
| <p>CCL</p>  <p>37 - 42</p> | <p>CRA</p>  <p>43 - 44</p> | <p>SOLDER LUGS</p>  <p>45</p> | <p>CT</p>  <p>46</p> | <p>CTL</p>  <p>47</p> | <p>CCS</p>  <p>48</p> |
| <p>ALNS</p>  <p>49 - 50</p> | <p>ALND</p>  <p>51 - 53</p> | <p>ALNN</p>  <p>54 - 56</p> | <p>ASN</p>  <p>57</p> | <p>ASL</p>  <p>58</p> | <p>F2C</p>  <p>59</p> |
| <p>CPM</p>  <p>60 - 62</p> | <p>CPML</p>  <p>62</p> | <p>ACMN, ACON</p>  <p>63 - 66</p> | <p>IACL</p>  <p>67</p> | <p>2IACL</p>  <p>68</p> | <p>UCS</p>  <p>69</p> |
| <p>PICS</p>  <p>70</p> | <p>P840</p>  <p>71</p> | <p>AH</p>  <p>72</p> | <p>HT</p>  <p>73</p> | <p>INFORMATION SHEETS</p> <p>74 - 81</p> | <p>COMPRESSION DIE INDEXES</p> <p>82 - 83</p> |
| <p>ILC-15, ILC-15H, ILC-750</p>  <p>84</p> | | | | | |









Pictorial Index

ILSCONS

| | | | | | |
|--------------------------------------------------------------------------------------------------------------------------------------------|-------------------------------------------------------------------------------------------------------------------------------------------------------------|----------------------------------------------------------------------------------------------------------------------------------------------------------|----------------------------------------------------------------------------------------------------------------------------------------------------------------------|---------------------------------------------------------------------------------------------------------------------------------------------|----------------------------------------------------------------------------------------------------------------------------------------------------------------------|
| Insulated Ring Terminals  86 | Spades/Forks Flanged Forks  87 | Splices, Disconnects, Bullets  88 | Crimp 'N Seal Kits  89 | Ring Terminals Non-Insulated  90 -93 | Ring Terminals Vinyl Insulated  94 - 95 |
| Ring Terminals Nylon Insulated  96 | High Temperature Ring Terminals Non-Insulated  97 | Ring Terminals Nylon Insulated Heavy Duty Double Crimp  98 | Ring Terminals Multi Stud  99 | Spade Terminals Non-Insulated  100 | Spade Terminals Vinyl Insulated  101 |
| Spade Terminals Nylon Insulated  102 | Spade Terminals Nylon Insulated Heavy Duty Double Crimp  103 | Locking Spade Terminals Non-Insulated  104 | Locking Spade Terminals Nylon Insulated  105 | Locking Spade Terminals Vinyl Insulated  106 | Locking Spade Terminals Nylon Insulated Heavy Duty Double Crimp  107 |
| Flanged Spade Terminals Non-Insulated  108 | Flanged Spade Terminals Nylon Insulated  109 | Flanged Spade Terminals Vinyl Insulated  110 | Flanged Spade Terminals Nylon Insulated Heavy Duty Double Crimp  111 | Fork Terminals Non-Insulated  112 | Fork Terminals Nylon Insulated  113 |
| Fork Terminals Vinyl Insulated  114 | Fork Terminals Nylon Insulated Heavy Duty Double Crimp  115 | Disconnect Terminals Standard Female  116 | Disconnect Terminals Standard Male  117 | Disconnect Terminals Fully Insulated  118 | Disconnect Terminals Fully Insulated, Flag  119 |
| Disconnect Terminals Bullet  120 | Pin Terminals Insulated  121 | Splices Non-Insulated  122 | Splices Vinyl Insulated  123 | Splices Insulated  124 | |
| | | Cool Seal Splices Sealed; Insulated  125 | Crimping Tools 94130  126 | Crimping Tools 94145  126 | |



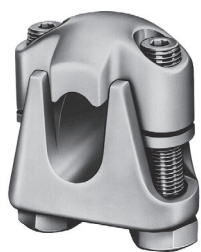

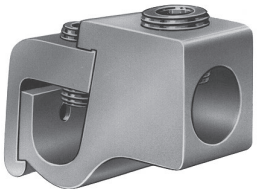
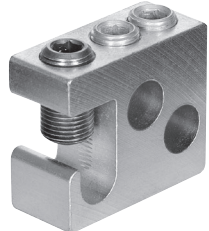
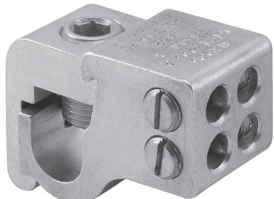
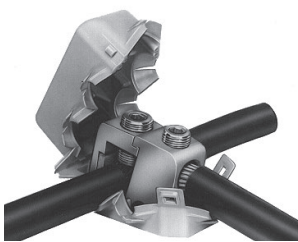

Pictorial Index

Split Bolts

| | | |
|------------------------------------------------------------------------------------------------------------------|------------------------------------------------------------------------------------------------------------|---------------------------------------------------------------------------------------------------------------------|
| <p>IK</p>  <p>128-129</p> | <p>IK3</p>  <p>130</p> | <p>SK</p>  <p>131</p> |
| <p>IKB</p>  <p>132</p> | <p>IKS</p>  <p>133</p> | <p>AK</p>  <p>134</p> |
| <p>DBA, DBA-S</p>  <p>135</p> | <p>IPC</p>  <p>136</p> | <p>GTT</p>  <p>137</p> |
| <p>GT2</p>  <p>138</p> | <p>GT4T</p>  <p>139</p> | <p>GTA/GTT KIT</p>  <p>140</p> |

Pictorial Index

Mechanical

| | | | | |
|---------------------------------------------------------------------------------------------------------------------------|-----------------------------------------------------------------------------------------------------------------------|------------------------------------------------------------------------------------------------------------------|-----------------------------------------------------------------------------------------------------------------------|----------------------------------------------------------------------------------------------------------------------|
| <p>TA-I-TC</p>  <p>143</p> | <p>AU-I-TC</p>  <p>144</p> | <p>TA</p>  <p>145</p> | <p>ATTA</p>  <p>146</p> | <p>AU</p>  <p>147</p> |
| <p>ATAU</p>  <p>148</p> | <p>T3A</p>  <p>149</p> | <p>T4A4</p>  <p>150</p> | <p>PB</p>  <p>151</p> | <p>PBHD</p>  <p>152</p> |
| <p>PBMW</p>  <p>153</p> | <p>TLK</p>  <p>154</p> | <p>USGL</p>  <p>155</p> | <p>SPA</p>  <p>156</p> | <p>CA</p>  <p>157</p> |
| <p>GTA</p>  <p>158</p> | <p>GTT</p>  <p>159</p> | <p>GTC</p>  <p>160</p> | <p>GT2</p>  <p>161</p> | <p>GT4T</p>  <p>162</p> |
| <p>MGTT</p>  <p>163</p> | <p>PTA</p>  <p>164</p> | <p>MAC</p>  <p>165</p> | <p>IPC</p>  <p>166</p> | <p>SGB</p>  <p>167</p> |
| <p>GH, GHS</p>  <p>168</p> | <p>GMS, GWL</p>  <p>169</p> | <p>GT</p>  <p>170</p> | <p>LS, LSN</p>  <p>171</p> | <p>PED-Z</p>  <p>172</p> |
| <p>PED-X, PSA-Z</p>  <p>173</p> | <p>PET</p>  <p>174</p> | <p>PTT</p>  <p>175</p> | <p>NB</p>  <p>176</p> | <p>NBAS</p>  <p>177</p> |

















Pictorial Index

Mechanical

| | | | | |
|--------------------------------------------------------------------------------------------------------------|-----------------------------------------------------------------------------------------------------------------|----------------------------------------------------------------------------------------------------------------|---------------------------------------------------------------------------------------------------------------|---------------------------------------------------------------------------------------------------------------|
| <p>NBAE</p>  <p>178</p> | <p>NBCE</p>  <p>179</p> | <p>NBST</p>  <p>180</p> | <p>SCNL</p>  <p>181</p> | <p>SCNM</p>  <p>182</p> |
| <p>USPASS</p>  <p>183</p> | <p>SS,SSK,SSKC</p>  <p>184</p> | <p>PG</p>  <p>185</p> | <p>GRM, GRF</p>  <p>186</p> | <p>SLU/SAU</p>  <p>187</p> |
| <p>SLS/SAS</p>  <p>187</p> | <p>E, H</p>  <p>188</p> | <p>SLUH</p>  <p>189</p> | <p>LO</p>  <p>190</p> | <p>VT/LO-S</p>  <p>191</p> |
| <p>XT, LY</p>  <p>192</p> | <p>CP</p>  <p>193</p> | <p>CO</p>  <p>194 - 195</p> | <p>SX</p>  <p>196</p> | <p>2SC</p>  <p>197</p> |
| <p>MU, LU</p>  <p>198</p> | <p>CL</p>  <p>199 - 200</p> | <p>HL</p>  <p>201</p> | <p>CL</p>  <p>202</p> | <p>H2L</p>  <p>203</p> |
| <p>H3L</p>  <p>204</p> | <p>D167</p>  <p>205</p> | <p>CAN</p>  <p>206</p> | <p>SK</p>  <p>207</p> | <p>TORQUE INDEX</p> <p>208</p> |











Pictorial Index

Insulated Mechanical

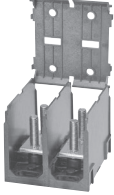
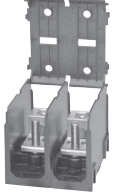
| | | | |
|-----------------------------------------------------------------------------------------------------------------------|-----------------------------------------------------------------------------------------------------------------------|--------------------------------------------------------------------------------------------------------------------------|---------------------------------------------------------------------------------------------------------------------------|
| <p>PBT</p>  <p>210</p> | <p>PBTO</p>  <p>211</p> | <p>PBTD</p>  <p>212 - 214</p> | <p>PBTS</p>  <p>215 - 217</p> |
| <p>PBTM</p>  <p>218 - 219</p> | <p>PBTF</p>  <p>200 - 223</p> | <p>PBTT</p>  <p>224</p> | <p>PBTL</p>  <p>225</p> |
| <p>PBTX</p>  <p>226</p> | <p>PBT2</p>  <p>227</p> | <p>PBTI</p>  <p>228</p> | <p>PBTFML KIT</p> <p>229</p> |
| <p>Common 3-Phase AC Motor Wiring Diagrams</p> <p>230</p> | <p>ECT</p>  <p>231</p> | <p>ECTS</p>  <p>232 - 234</p> | <p>ECTD</p>  <p>235 - 238</p> |
| <p>PCT</p>  <p>239</p> | <p>SPAR</p>  <p>240</p> | <p>MAC</p>  <p>241</p> | |

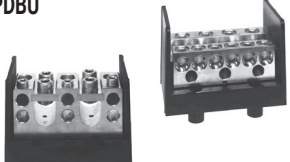



Pictorial Index

Insulated Piercing

| | | | |
|----------------------------------------------------------------------------------------------------------------|-----------------------------------------------------------------------------------------------------------------------|----------------------------------------------------------------------------------------------------------------|-----------------------------------------------------------------------------------------------------------------|
| <p>IPC</p>  <p>242 - 243</p> | <p>PDH</p>  <p>245 - 246</p> | | <p>PDE</p>  <p>247</p> |
| <p>PDL</p>  <p>248</p> | <p>PDS</p>  <p>249 - 250</p> | <p>PDM</p>  <p>251 - 252</p> | <p>LDAU/LDBU</p>  <p>253</p> |
| <p>PDBU</p>  <p>254 - 256</p> | <p>LDA/LDB Snap Bloc</p>  <p>257</p> | <p>PDA/PDC</p>  <p>258</p> | <p>PDB</p>  <p>259 - 264</p> |

Power Distribution Blocks

Grounding

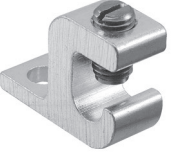
| | | | |
|-----------------------------------------------------------------------------------------------------------------|------------------------------------------------------------------------------------------------------------|------------------------------------------------------------------------------------------------------------------|-------------------------------------------------------------------------------------------------------------------|
| <p>GGB</p>  <p>268 - 270</p> | <p>CGP</p>  <p>271</p> | <p>RLT</p>  <p>272 - 274</p> | <p>SPS</p>  <p>275 - 276</p> |
| <p>SPD</p>  <p>277 - 278</p> | <p>TTGC</p>  <p>279</p> | <p>GPL</p>  <p>280 - 281</p> | <p>GS</p>  <p>282</p> |
| <p>D167</p>  <p>283</p> | <p>CAN</p>  <p>284</p> | <p>N-174</p>  <p>284</p> | <p>SGB</p>  <p>285</p> |
| <p>GBL</p>  <p>286</p> | <p>GRM</p>  <p>287</p> | <p>GRF</p>  <p>287</p> | <p>GH, GHS</p>  <p>288</p> |

Pictorial Index

Grounding (continued)

| | | | | | |
|---------------------------------------------------------------------------------------------------------------|---------------------------------------------------------------------------------------------------------------|---------------------------------------------------------------------------------------------------------------|---------------------------------------------------------------------------------------------------------|----------------------------------------------------------------------------------------------------------------|---------------------------------------------------------------------------------------------------------------|
| GMS, GWL  289 | GO  290 | GR  291 | GT  292 | GSE, HGSE  293 | GU  294 - 295 |
| LS, LSN  296 | NB  297 | NBAS  298 | NBAE  299 | NBCE  300 | NBST  301 |
| BBFC  302 - 305 | BBTA  306 - 307 | BBTC  308 - 309 | SCNL  310 | SCNM  311 | SBW  312 |
| SBC  313 | SBJ  314 | | | | |

Pictorial Index

Flex Braid

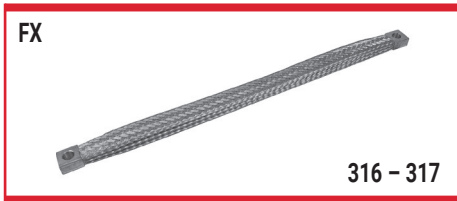

Underground

| | | | | | |
|-------------------------------------------|-----------------------------------------------|----------------------------------------------|-----------------------------------------------|---------------------------------------------|---------------------------------------------------|
| <p>DBK</p> <p>319</p> | <p>ASK</p> <p>319</p> | <p>USPASS</p> <p>320 - 321</p> | <p>SS, SSK, SSKC</p> <p>322</p> | <p>PEDSS</p> <p>323 - 324</p> | <p>STLSS, SLSS</p> <p>325 - 327</p> |
| <p>GGB</p> <p>328 - 329</p> | <p>SLU-DB, XT-DB</p> <p>330</p> | <p>RLT</p> <p>331 - 332</p> | <p>SPS</p> <p>333 - 334</p> | <p>SPD</p> <p>335 - 336</p> | <p>TTGC</p> <p>337</p> |

Heat Shrink

| | | | | | |
|-----------------------------------------------------|--------------------------------------------|------------------------------------------|---------------------------------------------|-------------------------------------------|--------------------------------------------|
| <p>SILICONE TAPE - SFT</p> <p>339</p> | <p>HEAVY WALL</p> <p>340</p> | <p>END CAPS</p> <p>341</p> | <p>MEDIUM WALL</p> <p>342</p> | <p>THIN WALL</p> <p>343</p> | <p>BULK REELS</p> <p>344</p> |
| <p>HEAT GUN</p> <p>345</p> | | | | | |

Pictorial Index

Tools

| | | | | |
|------------------------------------------------------------------------------------------------------------------------|------------------------------------------------------------------------------------------------------------------------|----------------------------------------------------------------------------------------------------------------------------------------|-----------------------------------------------------------------------------------------------------------------|------------------------------------------------------------------------------------------------------------------|
| <p>TACCI</p>  <p>347</p> | <p>BCTI</p>  <p>348-349</p> | <p>BCTI</p>  <p>350</p> | <p>BCTI</p>  <p>351</p> | <p>BCTR</p>  <p>352-361</p> |
| <p>HDTI</p>  <p>362-363</p> | <p>MHCT</p>  <p>364-365</p> | <p>HRTI</p>  <p>366-367</p> | <p>HRCT</p>  <p>368-370</p> | <p>HPI</p>  <p>371-373</p> |
| <p>HPI ACCESSORIES</p>  <p>374</p> | <p>DIE KIT</p>  <p>375</p> | <p>COMPRESSION DIES AND ADAPTORS</p>  <p>376-378</p> | <p>DINO DIES</p>  <p>379</p> | <p>W-DIES</p>  <p>380</p> |
| <p>MT-25</p>  <p>381</p> | <p>ND-58</p>  <p>382</p> | <p>ND-60</p>  <p>383</p> | <p>94285</p>  <p>384</p> | <p>ILC-10-N</p>  <p>385</p> |
| <p>94130, 94145</p>  <p>386</p> | <p>THT-SC-CC</p>  <p>387</p> | <p>WSI</p>  <p>388</p> | <p>WSI</p>  <p>389-395</p> | <p>CTRI</p>  <p>396</p> |
| <p>CTR-500, CTR-750</p>  <p>397</p> | <p>MECHANICAL TOOLS</p>  <p>398</p> | <p>HEAT GUN</p>  <p>399</p> | <p>COMPRESSION INDEX</p> <p>400 - 407</p> | |

Pictorial Index

Specialty

| | | | |
|------------------------------------------------------------------------------------------------------------------------------------------------------------------|-----------------------------------------------------------------------------------------------------------------------------------------------------------------------------|------------------------------------------------------------------------------------------------------------------------------------------------------------------------------------------|-------------------------------------------------------------------------------------------------------------------|
| <p>C</p>  <p>409</p> | <p>M</p>  <p>410</p> | <p>M</p>  <p>410</p> | <p>D167</p>  <p>411</p> |
| <p>CAN</p>  <p>412</p> | <p>NB</p>  <p>413</p> | <p>De-Ox</p>  <p>414</p> | |
| <p>DUCT SEAL</p>  <p>415</p> | <p>NBW</p>  <p>416</p> | <p>SSWC</p>  <p>417</p> | |
| <p>NWC</p>  <p>418</p> | <p>WM-B</p>  <p>419</p> | <p>WM</p>  <p>420 - 422</p> | |
| <p>Surge Protective Device Series RE - Residential</p>  <p>423</p> | <p>Surge Protective Device Series SE - Service Entrance</p>  <p>424 - 425</p> | <p>Surge Protective Device Series XE - Commercial & Industrial</p>  <p>426 - 427</p> | |

Compression

| | | | | | |
|-------------------------------------------------------------------------------------------------------------------------------------|----------------------------------------------------------------------------------------------------------------------|-----------------------------------------------------------------------------------------------------------------------------|---------------------------------------------------------------------------------------------------------------------|----------------------------------------------------------------------------------------------------------------------|-----------------------------------------------------------------------------------------------------------------------|
| <p>CSWS</p>  <p>2 - 4</p> | <p>CSWD</p>  <p>5 - 10</p> | <p>CLWS</p>  <p>11 - 13</p> | <p>CLNS</p>  <p>14 - 16</p> | <p>CLWD</p>  <p>17 - 22</p> | <p>CLND</p>  <p>23 - 28</p> |
| <p>CLNF</p>  <p>29 - 30</p> | <p>CLNU</p>  <p>31</p> | <p>CSWN</p>  <p>32</p> | <p>CLWN</p>  <p>33</p> | <p>CSLT</p>  <p>34 - 35</p> | <p>CLWU</p>  <p>36</p> |
| <p>CCL</p>  <p>37 - 42</p> | <p>CRA</p>  <p>43 - 44</p> | <p>SOLDER LUGS</p>  <p>45</p> | <p>CT</p>  <p>46</p> | <p>CTL</p>  <p>47</p> | <p>CCS</p>  <p>48</p> |
| <p>ALNS</p>  <p>49 - 50</p> | <p>ALND</p>  <p>51 - 53</p> | <p>ALNN</p>  <p>54 - 56</p> | <p>ASN</p>  <p>57</p> | <p>ASL</p>  <p>58</p> | <p>F2C</p>  <p>59</p> |
| <p>CPM</p>  <p>60 - 62</p> | <p>CPML</p>  <p>62</p> | <p>ACMN, ACON</p>  <p>63 - 66</p> | <p>IACL</p>  <p>67</p> | <p>2IACL</p>  <p>68</p> | <p>UCS</p>  <p>69</p> |
| <p>PICS</p>  <p>70</p> | <p>P840</p>  <p>71</p> | <p>AH</p>  <p>72</p> | <p>HT</p>  <p>73</p> | <p>INFORMATION SHEETS</p> <p>74 - 81</p> | <p>COMPRESSION DIE INDEXES</p> <p>82 - 83</p> |
| <p>ILC-15, ILC-15H, ILC-750</p>  <p>84</p> | | | | | |

nVent ILSCO SureCrimp Copper Compression Lugs

Standard Barrel - 1 Hole, w/Sight Hole

Conductor Range: 1/0 - #8



TYPE CSWS

Features

- Manufactured from high strength seamless copper tubing
- Electro-Tin plated
- Chamfered entry
- Color coded
- Suitable for use in circuits rated 35KV or less, proper high voltage spacing and insulation techniques must be used
- UL Listed and CSA Certified with nVent ILSCO and major competitor's compression tools
- UL467 Listed 500 kcmil - 10 AWG , #10 - #2 SOL
- For direct bury 500 kcmil - 10 grounding and bonding
- Rated to 90° C/194° F

Benefits

- Offers maximum conductivity and excellent crimping characteristics
- Provides low contact resistance
- For easy conductor insertion
- Identifies the proper compression die
- Application versatility

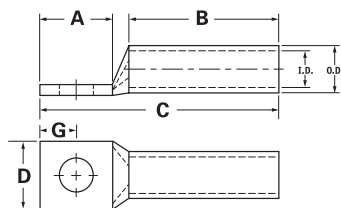

| Catalog Number | Wire Size | Alt Wire Size | Expanded* Wire Range | Bolt Size | Stud Hold Dia. | Dimensions (in.) | | | | | Die Color Code | Die Index | O.D. | I.QD |
|----------------|-----------|-----------------|----------------------|-----------|----------------|------------------|-------|-------|-------|-------|----------------|-----------|-------|-------|
| | | | | | | A | B | C | D | G | | | | |
| CSWS-8-10 | #8 AWG | #8 FLEX, #8 SOL | - | 10 | 0.219 | 0.562 | 0.500 | 1.257 | 0.374 | 0.258 | Red | I-21 | 0.272 | 0.179 |
| CSWS-8-14 | #8 AWG | #8 FLEX, #8 SOL | - | 1/4 | 0.281 | 0.680 | 0.500 | 1.375 | 0.486 | 0.320 | Red | I-21 | 0.272 | 0.179 |
| CSWS-8-516 | #8 AWG | #8 FLEX, #8 SOL | - | 5/16 | 0.343 | 0.875 | 0.500 | 1.570 | 0.532 | 0.352 | Red | I-21 | 0.272 | 0.179 |
| CSWS-8-38 | #8 AWG | #8 FLEX, #8 SOL | - | 3/8 | 0.406 | 0.875 | 0.500 | 1.570 | 0.593 | 0.414 | Red | I-21 | 0.272 | 0.179 |
| CSWS-6-10 | #6 AWG | #6 FLEX, #6 SOL | - | 10 | 0.219 | 0.562 | 0.500 | 1.257 | 0.440 | 0.258 | Blue | I-24 | 0.320 | 0.225 |
| CSWS-6-14 | #6 AWG | #6 FLEX, #6 SOL | - | 1/4 | 0.281 | 0.680 | 0.500 | 1.375 | 0.440 | 0.320 | Blue | I-24 | 0.320 | 0.225 |
| CSWS-6-516 | #6 AWG | #6 FLEX, #6 SOL | - | 5/16 | 0.343 | 0.875 | 0.500 | 1.570 | 0.530 | 0.352 | Blue | I-24 | 0.320 | 0.225 |
| CSWS-6-38 | #6 AWG | #6 FLEX, #6 SOL | - | 3/8 | 0.406 | 0.875 | 0.500 | 1.570 | 0.598 | 0.414 | Blue | I-24 | 0.320 | 0.225 |
| CSWS-6-12 | #6 AWG | #6 FLEX, #6 SOL | - | 1/2 | 0.562 | 1.250 | 0.500 | 1.945 | 0.755 | 0.546 | Blue | I-24 | 0.320 | 0.225 |
| CSWS-4-10 | #4 AWG | #4 SOL | 4-6 AWG | 10 | 0.219 | 0.562 | 0.500 | 1.296 | 0.486 | 0.258 | Gray | I-29 | 0.343 | 0.250 |
| CSWS-4-14 | #4 AWG | #4 SOL | 4-6 AWG | 1/4 | 0.281 | 0.680 | 0.500 | 1.414 | 0.486 | 0.320 | Gray | I-29 | 0.343 | 0.250 |
| CSWS-4-516 | #4 AWG | #4 SOL | 4-6 AWG | 5/16 | 0.343 | 0.875 | 0.500 | 1.609 | 0.486 | 0.352 | Gray | I-29 | 0.343 | 0.250 |
| CSWS-4-38 | #4 AWG | #4 SOL | 4-6 AWG | 3/8 | 0.406 | 0.875 | 0.500 | 1.609 | 0.593 | 0.414 | Gray | I-29 | 0.343 | 0.250 |
| CSWS-4-12 | #4 AWG | #4 SOL | 4-6 AWG | 1/2 | 0.562 | 1.250 | 0.500 | 1.984 | 0.750 | 0.546 | Gray | I-29 | 0.343 | 0.250 |
| CSWS-3-10 | #3 AWG | #4 FLEX | 3-6 AWG | 10 | 0.219 | 0.562 | 0.625 | 1.442 | 0.532 | 0.258 | White | I-29 | 0.375 | 0.275 |
| CSWS-3-14 | #3 AWG | #4 FLEX | 3-6 AWG | 1/4 | 0.281 | 0.680 | 0.625 | 1.560 | 0.532 | 0.320 | White | I-29 | 0.375 | 0.275 |
| CSWS-3-516 | #3 AWG | #4 FLEX | 3-6 AWG | 5/16 | 0.343 | 0.875 | 0.625 | 1.755 | 0.532 | 0.352 | White | I-29 | 0.375 | 0.275 |
| CSWS-3-38 | #3 AWG | #4 FLEX | 3-6 AWG | 3/8 | 0.406 | 0.875 | 0.625 | 1.755 | 0.593 | 0.414 | White | I-29 | 0.375 | 0.275 |
| CSWS-3-12 | #3 AWG | #4 FLEX | 3-6 AWG | 1/2 | 0.562 | 1.250 | 0.625 | 2.130 | 0.750 | 0.546 | White | I-29 | 0.375 | 0.275 |
| CSWS-2-10 | #2 AWG | #2 SOL | 2-6 AWG | 10 | 0.219 | 0.562 | 0.625 | 1.473 | 0.599 | 0.258 | Brown | I-33 | 0.421 | 0.312 |
| CSWS-2-14 | #2 AWG | #2 SOL | 2-6 AWG | 1/4 | 0.281 | 0.680 | 0.625 | 1.591 | 0.599 | 0.320 | Brown | I-33 | 0.421 | 0.312 |
| CSWS-2-516 | #2 AWG | #2 SOL | 2-6 AWG | 5/16 | 0.343 | 0.875 | 0.625 | 1.786 | 0.599 | 0.352 | Brown | I-33 | 0.421 | 0.312 |
| CSWS-2-38 | #2 AWG | #2 SOL | 2-6 AWG | 3/8 | 0.406 | 0.875 | 0.625 | 1.786 | 0.599 | 0.414 | Brown | I-33 | 0.421 | 0.312 |
| CSWS-2-12 | #2 AWG | #2 SOL | 2-6 AWG | 1/2 | 0.562 | 1.250 | 0.625 | 2.161 | 0.750 | 0.546 | Brown | I-33 | 0.421 | 0.312 |
| CSWS-1-10 | #1 AWG | #2 FLEX | 1-6 AWG | 10 | 0.219 | 0.562 | 0.625 | 1.517 | 0.673 | 0.258 | Green | I-37 | 0.468 | 0.359 |
| CSWS-1-14 | #1 AWG | #2 FLEX | 1-6 AWG | 1/4 | 0.281 | 0.875 | 0.625 | 1.830 | 0.673 | 0.320 | Green | I-37 | 0.468 | 0.359 |
| CSWS-1-516 | #1 AWG | #2 FLEX | 1-6 AWG | 5/16 | 0.343 | 0.875 | 0.625 | 1.830 | 0.673 | 0.352 | Green | I-37 | 0.468 | 0.359 |
| CSWS-1-38 | #1 AWG | #2 FLEX | 1-6 AWG | 3/8 | 0.406 | 0.875 | 0.625 | 1.830 | 0.673 | 0.414 | Green | I-37 | 0.468 | 0.359 |
| CSWS-1-12 | #1 AWG | #2 FLEX | 1-6 AWG | 1/2 | 0.562 | 1.250 | 0.625 | 2.205 | 0.750 | 0.546 | Green | I-37 | 0.468 | 0.359 |
| CSWS-1/0-10 | 1/0 AWG | #1 FLEX | 1/0-6 AWG | 10 | 0.219 | 0.562 | 0.850 | 1.768 | 0.738 | 0.258 | Pink | I-42 | 0.515 | 0.390 |
| CSWS-1/0-14 | 1/0 AWG | #1 FLEX | 1/0-6 AWG | 1/4 | 0.281 | 0.875 | 0.850 | 2.081 | 0.738 | 0.320 | Pink | I-42 | 0.515 | 0.390 |
| CSWS-1/0-516 | 1/0 AWG | #1 FLEX | 1/0-6 AWG | 5/16 | 0.343 | 0.875 | 0.850 | 2.081 | 0.738 | 0.352 | Pink | I-42 | 0.515 | 0.390 |
| CSWS-1/0-38 | 1/0 AWG | #1 FLEX | 1/0-6 AWG | 3/8 | 0.406 | 0.875 | 0.850 | 2.081 | 0.738 | 0.414 | Pink | I-42 | 0.515 | 0.390 |
| CSWS-1/0-12 | 1/0 AWG | #1 FLEX | 1/0-6 AWG | 1/2 | 0.562 | 1.250 | 0.850 | 2.456 | 0.738 | 0.546 | Pink | I-42 | 0.515 | 0.390 |

Tested to UL 486A/B, UL File E6207

All wire sizes, unless noted otherwise, are American Wire Gauge (AWG)

* When installed with specified dieless tools

See pages 80 to 90 for complete tooling information.

For Bent Tangs change the 4th letter to a B and add "-4" for 45 deg. or "-9" for 90 deg.

SureCrimp Copper Compression Lugs

Standard Barrel - 1 Hole, w/Sight Hole

Conductor Range: 400kcmil - 2/0



A TYPE CSWS

Features

- Manufactured from high strength seamless copper tubing
- Electro-Tin plated
- Chamfered entry
- Color coded
- Suitable for use in circuits rated 35KV or less, proper high voltage spacing and insulation techniques must be used
- UL Listed and CSA Certified with nVent ILSCO and major competitor's compression tools
- UL467 Listed 500 kcmil - 10 AWG , #10 - #2 SOL
- For direct bury 500 kcmil - 10 grounding and bonding
- Rated to 90° C/194° F

Benefits

- Offers maximum conductivity and excellent crimping characteristics
- Provides low contact resistance
- For easy conductor insertion
- Identifies the proper compression die
- Application versatility

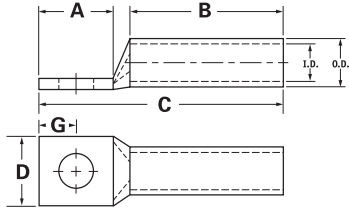

| Catalog Number | Wire Size | Alt Wire Size | Expanded* Wire Range | Bolt Size | Stud Hold Dia. | Dimensions (in.) | | | | | Die Color Code | Die Index | O.D. | I.D. |
|----------------|-----------|---------------------------------|----------------------|-----------|----------------|------------------|-------|-------|-------|-------|----------------|-----------|-------|-------|
| | | | | | | A | B | C | D | G | | | | |
| CSWS-2/0-10 | 2/0 AWG | 1/0 FLEX | 2/0-4 AWG | 10 | 0.219 | 0.562 | 0.850 | 1.808 | 0.811 | 0.258 | Black | I-45 | 0.562 | 0.437 |
| CSWS-2/0-14 | 2/0 AWG | 1/0 FLEX | 2/0-4 AWG | 1/4 | 0.281 | 0.875 | 0.850 | 2.121 | 0.811 | 0.320 | Black | I-45 | 0.562 | 0.437 |
| CSWS-2/0-516 | 2/0 AWG | 1/0 FLEX | 2/0-4 AWG | 5/16 | 0.343 | 0.875 | 0.850 | 2.121 | 0.811 | 0.352 | Black | I-45 | 0.562 | 0.437 |
| CSWS-2/0-38 | 2/0 AWG | 1/0 FLEX | 2/0-4 AWG | 3/8 | 0.406 | 0.875 | 0.850 | 2.121 | 0.811 | 0.414 | Black | I-45 | 0.562 | 0.437 |
| CSWS-2/0-12 | 2/0 AWG | 1/0 FLEX | 2/0-4 AWG | 1/2 | 0.562 | 1.250 | 0.850 | 2.496 | 0.811 | 0.546 | Black | I-45 | 0.562 | 0.437 |
| CSWS-3/0-10 | 3/0 AWG | 2/0 FLEX | 3/0-2 AWG | 10 | 0.219 | 0.562 | 0.850 | 1.851 | 0.885 | 0.258 | Orange | I-50 | 0.609 | 0.484 |
| CSWS-3/0-14 | 3/0 AWG | 2/0 FLEX | 3/0-2 AWG | 1/4 | 0.281 | 0.875 | 0.850 | 2.164 | 0.885 | 0.320 | Orange | I-50 | 0.609 | 0.484 |
| CSWS-3/0-516 | 3/0 AWG | 2/0 FLEX | 3/0-2 AWG | 5/16 | 0.343 | 0.875 | 0.850 | 2.164 | 0.885 | 0.352 | Orange | I-50 | 0.609 | 0.484 |
| CSWS-3/0-38 | 3/0 AWG | 2/0 FLEX | 3/0-2 AWG | 3/8 | 0.406 | 0.875 | 0.850 | 2.164 | 0.885 | 0.414 | Orange | I-50 | 0.609 | 0.484 |
| CSWS-3/0-12 | 3/0 AWG | 2/0 FLEX | 3/0-2 AWG | 1/2 | 0.562 | 1.250 | 0.850 | 2.539 | 0.885 | 0.546 | Orange | I-50 | 0.609 | 0.484 |
| CSWS-4/0-14 | 4/0 AWG | 3/0 FLEX | 4/0-1 AWG | 1/4 | 0.281 | 0.875 | 0.975 | 2.341 | 0.999 | 0.320 | Purple | I-54 | 0.687 | 0.546 |
| CSWS-4/0-516 | 4/0 AWG | 3/0 FLEX | 4/0-1 AWG | 5/16 | 0.343 | 0.875 | 0.975 | 2.341 | 0.999 | 0.352 | Purple | I-54 | 0.687 | 0.546 |
| CSWS-4/0-38 | 4/0 AWG | 3/0 FLEX | 4/0-1 AWG | 3/8 | 0.406 | 0.875 | 0.975 | 2.341 | 0.999 | 0.414 | Purple | I-54 | 0.687 | 0.546 |
| CSWS-4/0-12 | 4/0 AWG | 3/0 FLEX | 4/0-1 AWG | 1/2 | 0.562 | 1.250 | 0.975 | 2.716 | 0.999 | 0.546 | Purple | I-54 | 0.687 | 0.546 |
| CSWS-250-516 | 250kcmil | 4/0 FLEX | 250kcmil - 1/0 AWG | 5/16 | 0.343 | 0.875 | 1.163 | 2.569 | 1.088 | 0.352 | Yellow | I-62 | 0.750 | 0.593 |
| CSWS-250-38 | 250kcmil | 4/0 FLEX | 250kcmil - 1/0 AWG | 3/8 | 0.406 | 0.875 | 1.163 | 2.569 | 1.088 | 0.414 | Yellow | I-62 | 0.750 | 0.593 |
| CSWS-250-12 | 250kcmil | 4/0 FLEX | 250kcmil - 1/0 AWG | 1/2 | 0.562 | 1.250 | 1.163 | 2.944 | 1.088 | 0.546 | Yellow | I-62 | 0.750 | 0.593 |
| CSWS-300-516 | 300kcmil | 250 G,H FLEX | 300kcmil - 2/0 AWG | 5/16 | 0.343 | 0.875 | 1.163 | 2.625 | 1.189 | 0.352 | White | I-66 | 0.812 | 0.660 |
| CSWS-300-38 | 300kcmil | 250 G,H FLEX | 300kcmil - 2/0 AWG | 3/8 | 0.406 | 0.875 | 1.163 | 2.625 | 1.189 | 0.414 | White | I-66 | 0.812 | 0.660 |
| CSWS-300-12 | 300kcmil | 250 G,H FLEX | 300kcmil - 2/0 AWG | 1/2 | 0.562 | 1.250 | 1.163 | 3.000 | 1.189 | 0.546 | White | I-66 | 0.812 | 0.660 |
| CSWS-300-58 | 300kcmil | 250 G,H FLEX | 300kcmil - 2/0 AWG | 5/8 | 0.656 | 1.437 | 1.163 | 3.187 | 1.189 | 0.671 | White | I-66 | 0.812 | 0.660 |
| CSWS-350-38 | 350kcmil | 250 I,K,M FLEX 262.2 DLO | 350kcmil - 3/0 AWG | 3/8 | 0.406 | 0.875 | 1.063 | 2.561 | 1.291 | 0.414 | Red | I-71 | 0.890 | 0.703 |
| CSWS-350-12 | 350kcmil | 250 I,K,M FLEX 262.2 DLO | 350kcmil - 3/0 AWG | 1/2 | 0.562 | 1.250 | 1.063 | 2.936 | 1.291 | 0.546 | Red | I-71 | 0.890 | 0.703 |
| CSWS-350-58 | 350kcmil | 250 I,K,M FLEX 262.2 DLO | 350kcmil - 3/0 AWG | 5/8 | 0.656 | 1.437 | 1.063 | 3.123 | 1.291 | 0.671 | Red | I-71 | 0.890 | 0.703 |
| CSWS-400-38 | 400kcmil | 300 G,H,I,K,M FLEX 313.1 DLO | 400kcmil - 4/0 AWG | 3/8 | 0.406 | 0.875 | 1.188 | 2.730 | 1.365 | 0.414 | Blue | I-76 | 0.937 | 0.750 |
| CSWS-400-12 | 400kcmil | 300 G,H,I,K,M FLEX 313.1 DLO | 400kcmil - 4/0 AWG | 1/2 | 0.562 | 1.250 | 1.188 | 3.105 | 1.365 | 0.546 | Blue | I-76 | 0.937 | 0.750 |
| CSWS-400-58 | 400kcmil | 300 G,H,I,K,M FLEX 313.1 DLO | 400kcmil - 4/0 AWG | 5/8 | 0.656 | 1.437 | 1.188 | 3.292 | 1.365 | 0.671 | Blue | I-76 | 0.937 | 0.750 |

Tested to UL 486A/B, UL File E6207

All wire sizes, unless noted otherwise, are American Wire Gauge (AWG)

* When installed with specified dieless tools

See pages 80 to 90 for complete tooling information.

For Bent Tangs change the 4th letter to a B and add "-4" for 45 deg. or "-9" for 90 deg.

SureCrimp Copper Compression Lugs

Standard Barrel - 1 Hole, w/Sight Hole

Conductor Range: 1000kcmil - 500kcmil



TYPE CSWS

Features

- Manufactured from high strength seamless copper tubing
- Electro-Tin plated
- Chamfered entry
- Color coded
- Suitable for use in circuits rated 35KV or less, proper high voltage spacing and insulation techniques must be used
- UL Listed and CSA Certified with nVent ILSCO and major competitor's compression tools
- UL467 Listed 500 kcmil - 10 AWG , #10 - #2 SOL
- For direct bury 500 kcmil - 10 grounding and bonding
- Rated to 90° C/194° F

Benefits

- Offers maximum conductivity and excellent crimping characteristics
- Provides low contact resistance
- For easy conductor insertion
- Identifies the proper compression die
- Application versatility

A

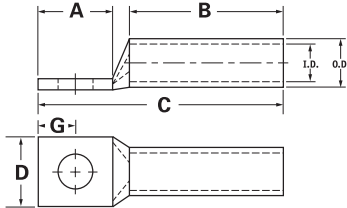

| Catalog Number | Wire Size | Alt Wire Size | Expanded* Wire Range | Bolt Size | Stud Hold Dia. | Dimensions (in.) | | | | | Die Color Code | Die Index | O.D. | I.D. |
|----------------|-----------|------------------------------|----------------------|-----------|----------------|------------------|-------|-------|-------|-------|----------------|-----------|-------|-------|
| | | | | | | A | B | C | D | G | | | | |
| CSWS500-38 | 500kcmil | 350 G,H,I,K,M FLEX 373.7 DLO | 500kcmil - 250kcmil | 3/8 | 0.406 | 0.875 | 1.300 | 2.907 | 1.535 | 0.546 | Brown | I-87 | 1.062 | 0.828 |
| CSWS-500-12 | 500kcmil | 350 G,H,I,K,M FLEX 373.7 DLO | 500kcmil - 250kcmil | 1/2 | 0.562 | 1.250 | 1.300 | 3.282 | 1.535 | 0.414 | Brown | I-87 | 1.062 | 0.828 |
| CSWS-500-58 | 500kcmil | 350 G,H,I,K,M FLEX 373.7 DLO | 500kcmil - 250kcmil | 5/8 | 0.656 | 1.437 | 1.300 | 3.469 | 1.535 | 0.671 | Brown | I-87 | 1.062 | 0.828 |
| CSWS-600-38 | 600kcmil | 400 G,H,I,K,M FLEX 444.4 DLO | 600kcmil - 250kcmil | 3/8 | 0.406 | 0.875 | 1.375 | 3.059 | 1.712 | 0.414 | Green | I-94 | 1.187 | 0.920 |
| CSWS-600-12 | 600kcmil | 400 G,H,I,K,M FLEX 444.4 DLO | 600kcmil - 250kcmil | 1/2 | 0.562 | 1.250 | 1.375 | 3.434 | 1.712 | 0.546 | Green | I-94 | 1.187 | 0.920 |
| CSWS-600-58 | 600kcmil | 400 G,H,I,K,M FLEX 444.4 DLO | 600kcmil - 250kcmil | 5/8 | 0.656 | 1.437 | 1.375 | 3.621 | 1.712 | 0.671 | Green | I-94 | 1.187 | 0.920 |
| CSWS-650-516 | 650kcmil | 500 G,H,I,K,M FLEX 535.3 DLO | 650kcmil - 350kcmil | 5/16 | 0.343 | 0.875 | 1.375 | 3.119 | 1.764 | 0.352 | Pink | I-99 | 1.217 | 0.958 |
| CSWS-650-38 | 650kcmil | 500 G,H,I,K,M FLEX 535.3 DLO | 650kcmil - 350kcmil | 3/8 | 0.406 | 0.875 | 1.375 | 3.119 | 1.764 | 0.414 | Pink | I-99 | 1.217 | 0.958 |
| CSWS-650-12 | 650kcmil | 500 G,H,I,K,M FLEX 535.3 DLO | 650kcmil - 350kcmil | 1/2 | 0.562 | 1.25 | 1.375 | 3.494 | 1.764 | 0.546 | Pink | I-99 | 1.217 | 0.958 |
| CSWS-650-58 | 650kcmil | 500 G,H,I,K,M FLEX 535.3 DLO | 650kcmil - 350kcmil | 5/8 | 0.656 | 1.437 | 1.375 | 3.681 | 1.764 | 0.671 | Pink | I-99 | 1.217 | 0.958 |
| CSWS-700-38 | 700kcmil | 500 G,H,I,K,M FLEX 535.3 DLO | 700kcmil - 350kcmil | 3/8 | 0.406 | 0.875 | 1.375 | 3.119 | 1.816 | 0.414 | Pink | I-99 | 1.250 | 0.991 |
| CSWS-700-12 | 700kcmil | 500 G,H,I,K,M FLEX 535.3 DLO | 700kcmil - 350kcmil | 1/2 | 0.562 | 1.250 | 1.375 | 3.494 | 1.816 | 0.546 | Pink | I-99 | 1.250 | 0.991 |
| CSWS-700-58 | 700kcmil | 500 G,H,I,K,M FLEX 535.3 DLO | 700kcmil - 350kcmil | 5/8 | 0.656 | 1.437 | 1.375 | 3.681 | 1.816 | 0.671 | Pink | I-99 | 1.250 | 0.991 |
| CSWS-750-38 | 750kcmil | 600 G,H,I,M FLEX 646.4 DLO | 750 kcmil - 500kcmil | 3/8 | 0.406 | 0.875 | 1.500 | 3.277 | 1.901 | 0.414 | Black | I-106 | 1.313 | 1.031 |
| CSWS-750-12 | 750kcmil | 600 G,H,I,M FLEX 646.4 DLO | 750kcmil - 500kcmil | 1/2 | 0.562 | 1.250 | 1.500 | 3.652 | 1.901 | 0.546 | Black | I-106 | 1.313 | 1.031 |
| CSWS-750-58 | 750kcmil | 600 G,H,I,M FLEX 646.4 DLO | 750kcmil - 500kcmil | 5/8 | 0.656 | 1.437 | 1.500 | 3.839 | 1.901 | 0.671 | Black | I-106 | 1.313 | 1.031 |
| CSWS-1000-38 | 1000kcmil | 750 G,H,I FLEX 777.7 DLO | 1000kcmil - 750kcmil | 3/8 | 0.406 | 0.875 | 1.625 | 3.525 | 2.169 | 0.414 | White | I-125 | 1.500 | 1.172 |
| CSWS-1000-12 | 1000kcmil | 750 G,H,I FLEX 777.7 DLO | 1000kcmil - 750kcmil | 1/2 | 0.562 | 1.250 | 1.625 | 3.900 | 2.169 | 0.546 | White | I-125 | 1.500 | 1.172 |
| CSWS-1000-58 | 1000kcmil | 750 G,H,I FLEX 777.7 DLO | 1000kcmil - 750kcmil | 5/8 | 0.656 | 1.437 | 1.625 | 4.087 | 2.169 | 0.671 | White | I-125 | 1.500 | 1.172 |

Tested to UL 486A/B, UL File E6207

All wire sizes, unless noted otherwise, are American Wire Gauge (AWG)

* When installed with specified dieless tools

See pages 80 to 90 for complete tooling information.

For Bent Tangs change the 4th letter to a B and add "-4" for 45 deg. or "-9" for 90 deg.

SureCrimp Copper Compression Lugs

Standard Barrel - 2 Hole, w/Sight Hole

Conductor Range: #6 - #8



A TYPE CSWD

Features

- Manufactured from high strength seamless copper tubing
- Electro-Tin plated
- Chamfered entry
- Color coded
- Suitable for use in circuits rated 35KV or less, proper high voltage spacing and insulation techniques must be used
- UL Listed and CSA Certified with nVent ILSCO and major competitor's compression tools
- UL467 Listed 500 kcmil - 10 AWG , #10 - #2 SOL
- For direct bury 500 kcmil - 10 grounding and bonding
- Rated to 90° C/194° F

Benefits

- Offers maximum conductivity and excellent crimping characteristics
- Provides low contact resistance
- For easy conductor insertion
- Identifies the proper compression die
- Application versatility

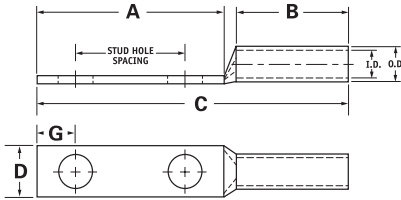

| Catalog Number | Wire Size | Alt Wire Size | Expanded* Wire Range | Bolt Size | Stud Hold Dia. | Stud Hole Spacing | Dimensions (in.) | | | | | Die Color Code | Die Index | O.D. | I.D. |
|----------------|-----------|-----------------|----------------------|-----------|----------------|-------------------|------------------|-------|-------|-------|-------|----------------|-----------|-------|-------|
| | | | | | | | A | B | C | D | G | | | | |
| CSWD-8-10-58 | #8 AWG | #8 FLEX, #8 SOL | - | 10 | 0.219 | 0.625 | 1.250 | 0.500 | 1.945 | 0.374 | 0.258 | Red | I-21 | 0.272 | 0.179 |
| CSWD-8-10-34 | #8 AWG | #8 FLEX, #8 SOL | - | 10 | 0.219 | 0.750 | 1.437 | 0.500 | 2.132 | 0.374 | 0.258 | Red | I-21 | 0.272 | 0.179 |
| CSWD-8-14-58 | #8 AWG | #8 FLEX, #8 SOL | - | 1/4 | 0.281 | 0.625 | 1.437 | 0.500 | 2.132 | 0.486 | 0.320 | Red | I-21 | 0.272 | 0.179 |
| CSWD-8-14-34 | #8 AWG | #8 FLEX, #8 SOL | - | 1/4 | 0.281 | 0.750 | 1.437 | 0.500 | 2.132 | 0.486 | 0.320 | Red | I-21 | 0.272 | 0.179 |
| CSWD-8-14-1 | #8 AWG | #8 FLEX, #8 SOL | - | 1/4 | 0.281 | 1.000 | 1.687 | 0.500 | 2.382 | 0.486 | 0.320 | Red | I-21 | 0.272 | 0.179 |
| CSWD-8-38-1 | #8 AWG | #8 FLEX, #8 SOL | - | 3/8 | 0.406 | 1.000 | 1.937 | 0.500 | 2.632 | 0.593 | 0.414 | Red | I-21 | 0.272 | 0.179 |
| CSWD-6-10-12 | #6 AWG | #6 FLEX, #6 SOL | - | 10 | 0.219 | 0.500 | 1.250 | 0.500 | 1.945 | 0.440 | 0.258 | Blue | I-24 | 0.320 | 0.225 |
| CSWD-6-10-58 | #6 AWG | #6 FLEX, #6 SOL | - | 10 | 0.219 | 0.625 | 1.250 | 0.500 | 1.945 | 0.440 | 0.258 | Blue | I-24 | 0.320 | 0.225 |
| CSWD-6-10-1116 | #6 AWG | #6 FLEX, #6 SOL | - | 10 | 0.219 | 0.687 | 1.250 | 0.500 | 1.945 | 0.440 | 0.258 | Blue | I-24 | 0.320 | 0.225 |
| CSWD-6-10-34 | #6 AWG | #6 FLEX, #6 SOL | - | 10 | 0.219 | 0.750 | 1.437 | 0.500 | 2.132 | 0.440 | 0.258 | Blue | I-24 | 0.320 | 0.225 |
| CSWD-6-14-12 | #6 AWG | #6 FLEX, #6 SOL | - | 1/4 | 0.281 | 0.500 | 1.250 | 0.500 | 1.945 | 0.440 | 0.320 | Blue | I-24 | 0.320 | 0.225 |
| CSWD-6-14-58 | #6 AWG | #6 FLEX, #6 SOL | - | 1/4 | 0.281 | 0.625 | 1.437 | 0.500 | 2.132 | 0.440 | 0.320 | Blue | I-24 | 0.320 | 0.225 |
| CSWD-6-14-34 | #6 AWG | #6 FLEX, #6 SOL | - | 1/4 | 0.281 | 0.750 | 1.437 | 0.500 | 2.132 | 0.440 | 0.320 | Blue | I-24 | 0.320 | 0.225 |
| CSWD-6-14-1 | #6 AWG | #6 FLEX, #6 SOL | - | 1/4 | 0.281 | 1.000 | 1.687 | 0.500 | 2.382 | 0.440 | 0.320 | Blue | I-24 | 0.320 | 0.225 |
| CSWD-6-516-34 | #6 AWG | #6 FLEX, #6 SOL | - | 5/16 | 0.343 | 0.750 | 1.687 | 0.500 | 2.382 | 0.530 | 0.352 | Blue | I-24 | 0.320 | 0.225 |
| CSWD-6-516-1 | #6 AWG | #6 FLEX, #6 SOL | - | 5/16 | 0.343 | 1.000 | 1.937 | 0.500 | 2.632 | 0.530 | 0.352 | Blue | I-24 | 0.320 | 0.225 |
| CSWD-6-38-34 | #6 AWG | #6 FLEX, #6 SOL | - | 3/8 | 0.406 | 0.750 | 1.687 | 0.500 | 2.382 | 0.598 | 0.414 | Blue | I-24 | 0.320 | 0.225 |
| CSWD-6-38-78 | #6 AWG | #6 FLEX, #6 SOL | - | 3/8 | 0.406 | 0.875 | 1.937 | 0.500 | 2.632 | 0.598 | 0.414 | Blue | I-24 | 0.320 | 0.225 |
| CSWD-6-38-1 | #6 AWG | #6 FLEX, #6 SOL | - | 3/8 | 0.406 | 1.000 | 1.937 | 0.500 | 2.632 | 0.598 | 0.414 | Blue | I-24 | 0.320 | 0.225 |
| CSWD-6-12-134 | #6 AWG | #6 FLEX, #6 SOL | - | 1/2 | 0.562 | 1.750 | 3.000 | 0.500 | 3.695 | 0.755 | 0.546 | Blue | I-24 | 0.320 | 0.225 |

Tested to UL 486A/B, UL File E6207

All wire sizes, unless noted otherwise, are American Wire Gauge (AWG)

* When installed with specified dieless tools

See pages 80 to 90 for complete tooling information.

For Bent Tangs change the 4th letter to a B and add "4" for 45 deg. or "9" for 90 deg.

SureCrimp Copper Compression Lugs

Standard Barrel - 2 Hole, w/Sight Hole

Conductor Range: #3 - #4



TYPE CSWD

Features

- Manufactured from high strength seamless copper tubing
- Electro-Tin plated
- Chamfered entry
- Color coded
- Suitable for use in circuits rated 35KV or less, proper high voltage spacing and insulation techniques must be used
- UL Listed and CSA Certified with nVent ILSCO and major competitor's compression tools
- UL467 Listed 500 kcmil - 10 AWG , #10 - #2 SOL
- For direct bury 500 kcmil - 10 grounding and bonding
- Rated to 90° C/194° F

Benefits

- Offers maximum conductivity and excellent crimping characteristics
- Provides low contact resistance
- For easy conductor insertion
- Identifies the proper compression die
- Application versatility

A

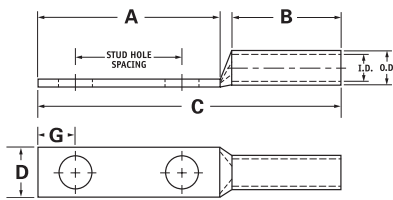

| Catalog Number | Wire Size | Alt Wire Size | Expanded* Wire Range | Bolt Size | Stud Hold Dia. | Stud Hole Spacing | Dimensions (in.) | | | | | Die Color Code | Die Index | O.D. | I.D. |
|----------------|-----------|---------------|----------------------|-----------|----------------|-------------------|------------------|-------|-------|-------|-------|----------------|-----------|-------|-------|
| | | | | | | | A | B | C | D | G | | | | |
| CSWD-4-10-58 | #4 AWG | #4 SOL | 4-6 AWG | 10 | 0.219 | 0.625 | 1.250 | 0.500 | 1.984 | 0.486 | 0.258 | Gray | I-29 | 0.343 | 0.250 |
| CSWD-4-10-34 | #4 AWG | #4 SOL | 4-6 AWG | 10 | 0.219 | 0.750 | 1.437 | 0.500 | 2.171 | 0.486 | 0.258 | Gray | I-29 | 0.343 | 0.250 |
| CSWD-4-10-1 | #4 AWG | #4 SOL | 4-6 AWG | 10 | 0.219 | 1.000 | 1.687 | 0.500 | 2.421 | 0.486 | 0.258 | Gray | I-29 | 0.343 | 0.250 |
| CSWD-4-14-58 | #4 AWG | #4 SOL | 4-6 AWG | 1/4 | 0.281 | 0.625 | 1.437 | 0.500 | 2.171 | 0.486 | 0.320 | Gray | I-29 | 0.343 | 0.250 |
| CSWD-4-14-34 | #4 AWG | #4 SOL | 4-6 AWG | 1/4 | 0.281 | 0.750 | 1.437 | 0.500 | 2.171 | 0.486 | 0.320 | Gray | I-29 | 0.343 | 0.250 |
| CSWD-4-14-1 | #4 AWG | #4 SOL | 4-6 AWG | 1/4 | 0.281 | 1.000 | 1.687 | 0.500 | 2.421 | 0.486 | 0.320 | Gray | I-29 | 0.343 | 0.250 |
| CSWD-4-516-1 | #4 AWG | #4 SOL | 4-6 AWG | 1/4 | 0.343 | 1.000 | 1.937 | 0.500 | 2.671 | 0.486 | 0.320 | Gray | I-29 | 0.343 | 0.250 |
| CSWD-4-38-34 | #4 AWG | #4 SOL | 4-6 AWG | 3/8 | 0.406 | 0.750 | 1.687 | 0.500 | 2.421 | 0.593 | 0.414 | Gray | I-29 | 0.343 | 0.250 |
| CSWD-4-38-1 | #4 AWG | #4 SOL | 4-6 AWG | 3/8 | 0.406 | 1.000 | 1.937 | 0.500 | 2.671 | 0.593 | 0.414 | Gray | I-29 | 0.343 | 0.250 |
| CSWD-4-12-134 | #4 AWG | #4 SOL | 4-6 AWG | 1/2 | 0.562 | 1.750 | 3.000 | 0.500 | 3.734 | 0.750 | 0.546 | Gray | I-29 | 0.343 | 0.250 |
| CSWD-3-14-58 | #3 AWG | #4 FLEX | 3-6 AWG | 1/4 | 0.281 | 0.625 | 1.437 | 0.625 | 2.317 | 0.532 | 0.320 | White | I-29 | 0.375 | 0.275 |
| CSWD-3-14-34 | #3 AWG | #4 FLEX | 3-6 AWG | 1/4 | 0.281 | 0.750 | 1.437 | 0.625 | 2.317 | 0.532 | 0.320 | White | I-29 | 0.375 | 0.275 |
| CSWD-3-516-1 | #3 AWG | #4 FLEX | 3-6 AWG | 5/16 | 0.343 | 1.000 | 1.937 | 0.625 | 2.817 | 0.532 | 0.352 | White | I-29 | 0.375 | 0.275 |
| CSWD-3-38-34 | #3 AWG | #4 FLEX | 3-6 AWG | 3/8 | 0.406 | 0.750 | 1.687 | 0.625 | 2.567 | 0.593 | 0.414 | White | I-29 | 0.375 | 0.275 |
| CSWD-3-38-1 | #3 AWG | #4 FLEX | 3-6 AWG | 3/8 | 0.406 | 1.000 | 1.937 | 0.625 | 2.817 | 0.593 | 0.414 | White | I-29 | 0.375 | 0.275 |
| CSWD-3-12-134 | #3 AWG | #4 FLEX | 3-6 AWG | 1/2 | 0.562 | 1.750 | 3.000 | 0.625 | 3.880 | 0.750 | 0.546 | White | I-29 | 0.375 | 0.275 |

Tested to UL 486A/B, UL File E6207

All wire sizes, unless noted otherwise, are American Wire Gauge (AWG)

* When installed with specified dieless tools

See pages 80 to 90 for complete tooling information.

For Bent Tangs change the 4th letter to a B and add "-4" for 45 deg. or "-9" for 90 deg.

SureCrimp Copper Compression Lugs

Standard Barrel - 2 Hole, w/Sight Hole

Conductor Range: 1/0 - #2



A TYPE CSWD

Features

- Manufactured from high strength seamless copper tubing
- Electro-Tin plated
- Chamfered entry
- Color coded
- Suitable for use in circuits rated 35KV or less, proper high voltage spacing and insulation techniques must be used
- UL Listed and CSA Certified with nVent ILSCO and major competitor's compression tools
- UL467 Listed 500 kcmil - 10 AWG , #10 - #2 SOL
- For direct bury 500 kcmil - 10 grounding and bonding
- Rated to 90° C/194° F

Benefits

- Offers maximum conductivity and excellent crimping characteristics
- Provides low contact resistance
- For easy conductor insertion
- Identifies the proper compression die
- Application versatility

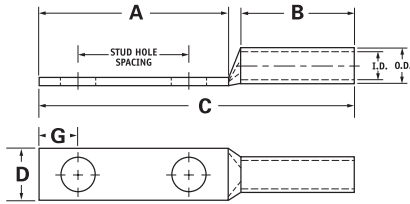

| Catalog Number | Wire Size | Alt Wire Size | Expanded* Wire Range | Bolt Size | Stud Hold Dia. | Stud Hole Spacing | Dimensions (in.) | | | | | Die Color Code | Die Index | O.D. | I.D. |
|-----------------|-----------|---------------|----------------------|-----------|----------------|-------------------|------------------|-------|-------|-------|-------|----------------|-----------|-------|-------|
| | | | | | | | A | B | C | D | G | | | | |
| CSWD-2-10-34 | #2 AWG | #2 SOL | 2-6 AWG | 10 | 0.219 | 0.750 | 1.437 | 0.625 | 2.348 | 0.599 | 0.258 | Brown | I-33 | 0.421 | 0.312 |
| CSWD-2-14-58 | #2 AWG | #2 SOL | 2-6 AWG | 1/4 | 0.281 | 0.625 | 1.437 | 0.625 | 2.348 | 0.599 | 0.320 | Brown | I-33 | 0.421 | 0.312 |
| CSWD-2-14-34 | #2 AWG | #2 SOL | 2-6 AWG | 1/4 | 0.281 | 0.750 | 1.437 | 0.625 | 2.348 | 0.599 | 0.320 | Brown | I-33 | 0.421 | 0.312 |
| CSWD-2-14-1 | #2 AWG | #2 SOL | 2-6 AWG | 1/4 | 0.281 | 1.000 | 1.687 | 0.625 | 2.598 | 0.599 | 0.320 | Brown | I-33 | 0.421 | 0.312 |
| CSWD-2-516-34 | #2 AWG | #2 SOL | 2-6 AWG | 5/16 | 0.343 | 0.750 | 1.687 | 0.625 | 2.598 | 0.599 | 0.352 | Brown | I-33 | 0.421 | 0.312 |
| CSWD-2-516-1 | #2 AWG | #2 SOL | 2-6 AWG | 5/16 | 0.343 | 1.000 | 1.937 | 0.625 | 2.848 | 0.599 | 0.352 | Brown | I-33 | 0.421 | 0.312 |
| CSWD-2-38-34 | #2 AWG | #2 SOL | 2-6 AWG | 3/8 | 0.406 | 0.750 | 1.687 | 0.625 | 2.598 | 0.599 | 0.414 | Brown | I-33 | 0.421 | 0.312 |
| CSWD-2-38-78 | #2 AWG | #2 SOL | 2-6 AWG | 3/8 | 0.406 | 0.875 | 1.937 | 0.625 | 2.848 | 0.599 | 0.414 | Brown | I-33 | 0.421 | 0.312 |
| CSWD-2-38-1 | #2 AWG | #2 SOL | 2-6 AWG | 3/8 | 0.406 | 1.000 | 1.937 | 0.625 | 2.848 | 0.599 | 0.414 | Brown | I-33 | 0.421 | 0.312 |
| CSWD-2-38-134 | #2 AWG | #2 SOL | 2-6 AWG | 3/8 | 0.406 | 1.750 | 2.625 | 0.625 | 3.536 | 0.599 | 0.414 | Brown | I-33 | 0.421 | 0.312 |
| CSWD-2-12-134 | #2 AWG | #2 SOL | 2-6 AWG | 1/2 | 0.562 | 1.750 | 3.000 | 0.625 | 3.911 | 0.750 | 0.546 | Brown | I-33 | 0.421 | 0.312 |
| CSWD-1-14-58 | #1 AWG | #2 FLEX | 1-6 AWG | 1/4 | 0.281 | 0.625 | 1.437 | 0.625 | 2.392 | 0.673 | 0.320 | Green | I-37 | 0.468 | 0.359 |
| CSWD-1-14-34 | #1 AWG | #2 FLEX | 1-6 AWG | 1/4 | 0.281 | 0.750 | 1.437 | 0.625 | 2.392 | 0.673 | 0.320 | Green | I-37 | 0.468 | 0.359 |
| CSWD-1-14-1 | #1 AWG | #2 FLEX | 1-6 AWG | 1/4 | 0.281 | 1.000 | 1.687 | 0.625 | 2.642 | 0.673 | 0.320 | Green | I-37 | 0.468 | 0.359 |
| CSWD-1-516-78 | #1 AWG | #2 FLEX | 1-6 AWG | 5/16 | 0.343 | 0.875 | 1.687 | 0.625 | 2.642 | 0.673 | 0.352 | Green | I-37 | 0.468 | 0.359 |
| CSWD-1-516-1 | #1 AWG | #2 FLEX | 1-6 AWG | 5/16 | 0.343 | 1.000 | 1.937 | 0.625 | 2.892 | 0.673 | 0.352 | Green | I-37 | 0.468 | 0.359 |
| CSWD-1-38-1 | #1 AWG | #2 FLEX | 1-6 AWG | 3/8 | 0.406 | 1.000 | 1.937 | 0.625 | 2.892 | 0.673 | 0.414 | Green | I-37 | 0.468 | 0.359 |
| CSWD-1-12-134 | #1 AWG | #2 FLEX | 1-6 AWG | 1/2 | 0.562 | 1.750 | 3.000 | 0.625 | 3.955 | 0.750 | 0.546 | Green | I-37 | 0.468 | 0.359 |
| CSWD-1/0-14-58 | 1/0 AWG | #1 FLEX | 1/0-6 AWG | 1/4 | 0.281 | 0.625 | 1.437 | 0.850 | 2.643 | 0.738 | 0.320 | Pink | I-42 | 0.515 | 0.390 |
| CSWD-1/0-14-34 | 1/0 AWG | #1 FLEX | 1/0-6 AWG | 1/4 | 0.281 | 0.750 | 1.437 | 0.850 | 2.643 | 0.738 | 0.320 | Pink | I-42 | 0.515 | 0.390 |
| CSWD-1/0-14-1 | 1/0 AWG | #1 FLEX | 1/0-6 AWG | 1/4 | 0.281 | 1.000 | 1.687 | 0.850 | 2.893 | 0.738 | 0.320 | Pink | I-42 | 0.515 | 0.390 |
| CSWD-1/0-516-34 | 1/0 AWG | #1 FLEX | 1/0-6 AWG | 5/16 | 0.343 | 0.750 | 1.687 | 0.850 | 2.893 | 0.738 | 0.352 | Pink | I-42 | 0.515 | 0.390 |
| CSWD-1/0-516-78 | 1/0 AWG | #1 FLEX | 1/0-6 AWG | 5/16 | 0.343 | 0.875 | 1.687 | 0.850 | 2.893 | 0.738 | 0.352 | Pink | I-42 | 0.515 | 0.390 |
| CSWD-1/0-516-1 | 1/0 AWG | #1 FLEX | 1/0-6 AWG | 5/16 | 0.343 | 1.000 | 1.937 | 0.850 | 3.143 | 0.738 | 0.352 | Pink | I-42 | 0.515 | 0.390 |
| CSWD-1/0-38-1 | 1/0 AWG | #1 FLEX | 1/0-6 AWG | 3/8 | 0.406 | 1.000 | 1.937 | 0.850 | 3.143 | 0.738 | 0.414 | Pink | I-42 | 0.515 | 0.390 |
| CSWD-1/0-38-134 | 1/0 AWG | #1 FLEX | 1/0-6 AWG | 3/8 | 0.406 | 1.750 | 2.625 | 0.850 | 3.831 | 0.738 | 0.414 | Pink | I-42 | 0.515 | 0.390 |
| CSWD-1/0-12-1 | 1/0 AWG | #1 FLEX | 1/0-6 AWG | 1/2 | 0.562 | 1.000 | 2.125 | 0.850 | 3.331 | 0.738 | 0.546 | Pink | I-42 | 0.515 | 0.390 |
| CSWD-1/0-12-134 | 1/0 AWG | #1 FLEX | 1/0-6 AWG | 1/2 | 0.562 | 1.750 | 3.000 | 0.850 | 4.206 | 0.738 | 0.546 | Pink | I-42 | 0.515 | 0.390 |

Tested to UL 486A/B, UL File E6207

All wire sizes, unless noted otherwise, are American Wire Gauge (AWG)

* When installed with specified dieless tools. See pages 80 to 90 for complete tooling information.

For Bent Tangs change the 4th letter to a B and add "-4" for 45 deg. or "-9" for 90 deg.

SureCrimp Copper Compression Lugs

Standard Barrel - 2 Hole, w/Sight Hole

Conductor Range: 4/0 - 2/0



TYPE CSWD

Features

- Manufactured from high strength seamless copper tubing
- Electro-Tin plated
- Chamfered entry
- Color coded
- Suitable for use in circuits rated 35KV or less, proper high voltage spacing and insulation techniques must be used
- UL Listed and CSA Certified with nVent ILSCO and major competitor's compression tools
- UL467 Listed 500 kcmil - 10 AWG , #10 - #2 SOL
- For direct bury 500 kcmil - 10 grounding and bonding
- Rated to 90° C/194° F

Benefits

- Offers maximum conductivity and excellent crimping characteristics
- Provides low contact resistance
- For easy conductor insertion
- Identifies the proper compression die
- Application versatility

A

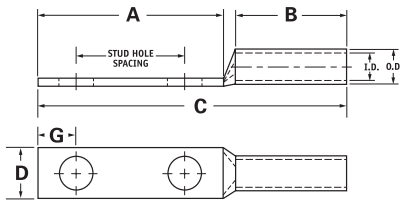

| Catalog Number | Wire Size | Alt Wire Size | Expanded* Wire Range | Bolt Size | Stud Hold Dia. | Stud Hole Spacing | Dimensions (in.) | | | | | Die Color Code | Die Index | O.D. | I.D. |
|------------------|-----------|---------------|----------------------|-----------|----------------|-------------------|------------------|-------|-------|-------|-------|----------------|-----------|-------|-------|
| | | | | | | | A | B | C | D | G | | | | |
| CSWD-2/0-14-58 | 2/0 AWG | 1/0 FLEX | 2/0-4 AWG | 1/4 | 0.281 | 0.625 | 1.437 | 0.850 | 2.683 | 0.811 | 0.320 | Black | I-45 | 0.562 | 0.437 |
| CSWD-2/0-14-34 | 2/0 AWG | 1/0 FLEX | 2/0-4 AWG | 1/4 | 0.281 | 0.750 | 1.437 | 0.850 | 2.683 | 0.811 | 0.320 | Black | I-45 | 0.562 | 0.437 |
| CSWD-2/0-14-1 | 2/0 AWG | 1/0 FLEX | 2/0-4 AWG | 1/4 | 0.281 | 1.000 | 1.687 | 0.850 | 2.933 | 0.811 | 0.320 | Black | I-45 | 0.562 | 0.437 |
| CSWD-2/0-516-78 | 2/0 AWG | 1/0 FLEX | 2/0-4 AWG | 5/16 | 0.343 | 0.875 | 1.687 | 0.850 | 2.933 | 0.811 | 0.352 | Black | I-45 | 0.562 | 0.437 |
| CSWD-2/0-516-1 | 2/0 AWG | 1/0 FLEX | 2/0-4 AWG | 5/16 | 0.343 | 1.000 | 1.937 | 0.850 | 3.183 | 0.811 | 0.352 | Black | I-45 | 0.562 | 0.437 |
| CSWD-2/0-38-1 | 2/0 AWG | 1/0 FLEX | 2/0-4 AWG | 3/8 | 0.406 | 1.000 | 1.937 | 0.850 | 3.183 | 0.811 | 0.414 | Black | I-45 | 0.562 | 0.437 |
| CSWD-2/0-38-134 | 2/0 AWG | 1/0 FLEX | 2/0-4 AWG | 3/8 | 0.406 | 1.750 | 2.625 | 0.850 | 3.871 | 0.811 | 0.414 | Black | I-45 | 0.562 | 0.437 |
| CSWD-2/0-12-1 | 2/0 AWG | 1/0 FLEX | 2/0-4 AWG | 1/2 | 0.562 | 1.000 | 2.125 | 0.850 | 3.371 | 0.811 | 0.546 | Black | I-45 | 0.562 | 0.437 |
| CSWD-2/0-12-134 | 2/0 AWG | 1/0 FLEX | 2/0-4 AWG | 1/2 | 0.562 | 1.750 | 3.000 | 0.850 | 4.246 | 0.811 | 0.546 | Black | I-45 | 0.562 | 0.437 |
| CSWD-3/0-14-58 | 3/0 AWG | 2/0 FLEX | 3/0-2 AWG | 1/4 | 0.281 | 0.625 | 1.437 | 0.850 | 2.726 | 0.885 | 0.320 | Orange | I-50 | 0.609 | 0.484 |
| CSWD-3/0-14-34 | 3/0 AWG | 2/0 FLEX | 3/0-2 AWG | 1/4 | 0.281 | 0.750 | 1.437 | 0.850 | 2.726 | 0.885 | 0.320 | Orange | I-50 | 0.609 | 0.484 |
| CSWD-3/0-516-1 | 3/0 AWG | 2/0 FLEX | 3/0-2 AWG | 5/16 | 0.343 | 1.000 | 1.937 | 0.850 | 3.226 | 0.885 | 0.352 | Orange | I-50 | 0.609 | 0.484 |
| CSWD-3/0-38-1 | 3/0 AWG | 2/0 FLEX | 3/0-2 AWG | 3/8 | 0.406 | 1.000 | 1.937 | 0.850 | 3.226 | 0.885 | 0.414 | Orange | I-50 | 0.609 | 0.484 |
| CSWD-3/0-12-134 | 3/0 AWG | 2/0 FLEX | 3/0-2 AWG | 1/2 | 0.562 | 1.750 | 3.000 | 0.850 | 4.289 | 0.885 | 0.546 | Orange | I-50 | 0.609 | 0.484 |
| CSWD-4/0-14-58 | 4/0 AWG | 3/0 FLEX | 4/0-1 AWG | 1/4 | 0.281 | 0.625 | 1.437 | 0.975 | 2.903 | 0.999 | 0.320 | Purple | I-54 | 0.687 | 0.546 |
| CSWD-4/0-14-34 | 4/0 AWG | 3/0 FLEX | 4/0-1 AWG | 1/4 | 0.281 | 0.750 | 1.437 | 0.975 | 2.903 | 0.999 | 0.320 | Purple | I-54 | 0.687 | 0.546 |
| CSWD-4/0-14-1 | 4/0 AWG | 3/0 FLEX | 4/0-1 AWG | 1/4 | 0.281 | 1.000 | 1.687 | 0.975 | 3.153 | 0.999 | 0.320 | Purple | I-54 | 0.687 | 0.546 |
| CSWD-4/0-516-34 | 4/0 AWG | 3/0 FLEX | 4/0-1 AWG | 5/16 | 0.343 | 0.750 | 1.687 | 0.975 | 3.153 | 0.999 | 0.352 | Purple | I-54 | 0.687 | 0.546 |
| CSWD-4/0-516-1 | 4/0 AWG | 3/0 FLEX | 4/0-1 AWG | 5/16 | 0.343 | 1.000 | 1.937 | 0.975 | 3.403 | 0.999 | 0.352 | Purple | I-54 | 0.687 | 0.546 |
| CSWD-4/0-516-134 | 4/0 AWG | 3/0 FLEX | 4/0-1 AWG | 5/16 | 0.343 | 1.750 | 2.500 | 0.975 | 3.966 | 0.999 | 0.352 | Purple | I-54 | 0.687 | 0.546 |
| CSWD-4/0-38-1 | 4/0 AWG | 3/0 FLEX | 4/0-1 AWG | 3/8 | 0.406 | 1.000 | 1.937 | 0.975 | 3.403 | 0.999 | 0.414 | Purple | I-54 | 0.687 | 0.546 |
| CSWD-4/0-38-134 | 4/0 AWG | 3/0 FLEX | 4/0-1 AWG | 3/8 | 0.406 | 1.750 | 2.625 | 0.975 | 4.091 | 0.999 | 0.414 | Purple | I-54 | 0.687 | 0.546 |
| CSWD-4/0-12-1 | 4/0 AWG | 3/0 FLEX | 4/0-1 AWG | 1/2 | 0.562 | 1.000 | 2.125 | 0.975 | 3.591 | 0.999 | 0.546 | Purple | I-54 | 0.687 | 0.546 |
| CSWD-4/0-12-114 | 4/0 AWG | 3/0 FLEX | 4/0-1 AWG | 1/2 | 0.562 | 1.250 | 2.500 | 0.975 | 3.966 | 0.999 | 0.546 | Purple | I-54 | 0.687 | 0.546 |
| CSWD-4/0-12-134 | 4/0 AWG | 3/0 FLEX | 4/0-1 AWG | 1/2 | 0.562 | 1.750 | 3.000 | 0.975 | 4.466 | 0.999 | 0.546 | Purple | I-54 | 0.687 | 0.546 |

Tested to UL 486A/B, UL File E6207

All wire sizes, unless noted otherwise, are American Wire Gauge (AWG)

* When installed with specified dieless tools

See pages 80 to 90 for complete tooling information.

For Bent Tangs change the 4th letter to a B and add "-4" for 45 deg. or "-9" for 90 deg.

SureCrimp Copper Compression Lugs

Standard Barrel - 2 Hole, w/Sight Hole

Conductor Range: 500kcmil - 250kcmil



A TYPE CSWD

Features

- Manufactured from high strength seamless copper tubing
- Electro-Tin plated
- Chamfered entry
- Color coded
- Suitable for use in circuits rated 35KV or less, proper high voltage spacing and insulation techniques must be used
- UL Listed and CSA Certified with nVent ILSCO and major competitor's compression tools
- UL467 Listed 500 kcmil - 10 AWG , #10 - #2 SOL
- For direct bury 500 kcmil - 10 grounding and bonding
- Rated to 90° C/194° F

Benefits

- Offers maximum conductivity and excellent crimping characteristics
- Provides low contact resistance
- For easy conductor insertion
- Identifies the proper compression die
- Application versatility

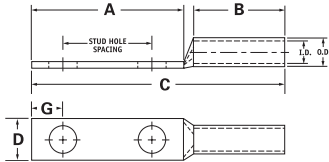

| Catalog Number | Wire Size | Alt Wire Size | Expanded* Wire Range | Bolt Size | Stud Hold Dia. | Stud Hole Spacing | Dimensions (in.) | | | | | Die Color Code | Die Index | O.D. | I.D. |
|------------------|-----------|------------------------------|----------------------|-----------|----------------|-------------------|------------------|-------|-------|-------|-------|----------------|-----------|-------|-------|
| | | | | | | | A | B | C | D | G | | | | |
| CSWD-250-14-34 | 250kcmil | 4/0 FLEX | 250kcmil - 1/0 AWG | 1/4 | 0.281 | 0.750 | 1.437 | 1.163 | 3.131 | 1.088 | 0.320 | Yellow | I-62 | 0.750 | 0.593 |
| CSWD-250-38-1 | 250kcmil | 4/0 FLEX | 250kcmil - 1/0 AWG | 3/8 | 0.406 | 1.00 | 1.937 | 1.163 | 3.631 | 1.088 | 0.414 | Yellow | I-62 | 0.750 | 0.593 |
| CSWD-250-38-134 | 250kcmil | 4/0 FLEX | 250kcmil - 1/0 AWG | 3/8 | 0.406 | 1.750 | 2.625 | 1.163 | 4.319 | 1.088 | 0.414 | Yellow | I-62 | 0.750 | 0.593 |
| CSWD-250-12-114 | 250kcmil | 4/0 FLEX | 250kcmil - 1/0 AWG | 1/2 | 0.562 | 1.250 | 2.500 | 1.163 | 4.194 | 1.088 | 0.546 | Yellow | I-62 | 0.750 | 0.593 |
| CSWD-250-12-134 | 250kcmil | 4/0 FLEX | 250kcmil - 1/0 AWG | 1/2 | 0.562 | 1.750 | 3.000 | 1.163 | 4.694 | 1.088 | 0.546 | Yellow | I-62 | 0.750 | 0.593 |
| CSWD-300-38-1 | 300kcmil | 250 G,H FLEX | 300kcmil - 2/0 AWG | 3/8 | 0.406 | 1.000 | 1.937 | 1.163 | 3.687 | 1.189 | 0.414 | White | I-66 | 0.812 | 0.660 |
| CSWD-300-12-134 | 300kcmil | 250 G,H FLEX | 300kcmil - 2/0 AWG | 1/2 | 0.562 | 1.750 | 3.000 | 1.163 | 4.750 | 1.189 | 0.546 | White | I-66 | 0.812 | 0.660 |
| CSWD-350-14-34 | 350kcmil | 250 I,K,M FLEX 262.2 DLO | 350kcmil - 3/0 AWG | 1/4 | 0.281 | 0.750 | 1.437 | 1.063 | 3.123 | 1.291 | 0.320 | Red | I-71 | 0.890 | 0.703 |
| CSWD-350-516-134 | 350kcmil | 250 I,K,M FLEX 262.2 DLO | 350kcmil - 3/0 AWG | 5/16 | 0.343 | 1.750 | 2.500 | 1.063 | 4.186 | 1.291 | 0.352 | Red | I-71 | 0.890 | 0.703 |
| CSWD-350-38-1 | 350kcmil | 250 I,K,M FLEX 262.2 DLO | 350kcmil - 3/0 AWG | 3/8 | 0.406 | 1.000 | 1.937 | 1.063 | 3.623 | 1.291 | 0.414 | Red | I-71 | 0.890 | 0.703 |
| CSWD-350-12-114 | 350kcmil | 250 I,K,M FLEX 262.2 DLO | 350kcmil - 3/0 AWG | 1/2 | 0.562 | 1.250 | 2.500 | 1.063 | 4.186 | 1.291 | 0.546 | Red | I-71 | 0.890 | 0.703 |
| CSWD-350-12-134 | 350kcmil | 250 I,K,M FLEX 262.2 DLO | 350kcmil - 3/0 AWG | 1/2 | 0.562 | 1.750 | 3.000 | 1.063 | 4.686 | 1.291 | 0.546 | Red | I-71 | 0.890 | 0.703 |
| CSWD-400-38-1 | 400kcmil | 300 G,H,I,K,M FLEX 313.1 DLO | 400kcmil - 4/0 AWG | 3/8 | 0.406 | 1.000 | 1.937 | 1.188 | 3.792 | 1.365 | 0.414 | Blue | I-76 | 0.937 | 0.750 |
| CSWD-400-38-116 | 400kcmil | 300 G,H,I,K,M FLEX 313.1 DLO | 400kcmil - 4/0 AWG | 3/8 | 0.406 | 1.062 | 1.937 | 1.188 | 3.792 | 1.365 | 0.414 | Blue | I-76 | 0.937 | 0.750 |
| CSWD-400-12-134 | 400kcmil | 300 G,H,I,K,M FLEX 313.1 DLO | 400kcmil - 4/0 AWG | 1/2 | 0.562 | 1.750 | 3.000 | 1.188 | 4.855 | 1.365 | 0.546 | Blue | I-76 | 0.937 | 0.750 |
| CSWD-500-14-34 | 500kcmil | 350 G,H,I,K,M FLEX 373.7 DLO | 500kcmil - 250kcmil | 1/4 | 0.281 | 0.750 | 1.437 | 1.300 | 3.469 | 1.535 | 0.320 | Brown | I-87 | 1.062 | 0.828 |
| CSWD-500-38-1 | 500kcmil | 350 G,H,I,K,M FLEX 373.7 DLO | 500kcmil - 250kcmil | 3/8 | 0.406 | 1.000 | 1.937 | 1.300 | 3.969 | 1.535 | 0.414 | Brown | I-87 | 1.062 | 0.828 |
| CSWD-500-12-114 | 500kcmil | 350 G,H,I,K,M FLEX 373.7 DLO | 500kcmil - 250kcmil | 1/2 | 0.562 | 1.250 | 2.500 | 1.300 | 4.532 | 1.535 | 0.546 | Brown | I-87 | 1.062 | 0.828 |
| CSWD-500-12-134 | 500kcmil | 350 G,H,I,K,M FLEX 373.7 DLO | 500kcmil - 250kcmil | 1/2 | 0.562 | 1.750 | 3.000 | 1.300 | 5.032 | 1.535 | 0.546 | Brown | I-87 | 1.062 | 0.828 |

Tested to UL 486A/B, UL File E6207 All wire sizes, unless noted otherwise, are American Wire Gauge (AWG). * When installed with specified dieless tools. See pages 80 to 90 for complete tooling information. For Bent Tangs change the 4th letter to a B and add "4" for 45 deg. or "9" for 90 deg.

SureCrimp Copper Compression Lugs

Standard Barrel - 2 Hole w/Sight Hole

Conductor Range: 1000kcmil - 600kcmil



TYPE CSWD

Features

- Manufactured from high strength seamless copper tubing
- Electro-Tin plated
- Chamfered entry
- Color coded
- Suitable for use in circuits rated 35KV or less, proper high voltage spacing and insulation techniques must be used
- UL Listed and CSA Certified with nVent ILSCO and major competitor's compression tools
- UL467 Listed 500 kcmil - 10 AWG , #10 - #2 SOL
- For direct bury 500 kcmil - 10 grounding and bonding
- Rated to 90° C/194° F

Benefits

- Offers maximum conductivity and excellent crimping characteristics
- Provides low contact resistance
- For easy conductor insertion
- Identifies the proper compression die
- Application versatility

A

| Catalog Number | Wire Size | Alt Wire Size | Expanded* Wire Range | Bolt Size | Stud Hold Dia. | Stud Hole Spacing | Dimensions (in.) | | | | | Die Color Code | Die Index | O.D. | I.D. |
|------------------|-----------|------------------------------|----------------------|-----------|----------------|-------------------|------------------|-------|-------|-------|-------|----------------|-----------|-------|-------|
| | | | | | | | A | B | C | D | G | | | | |
| CSWD-600-38-1 | 600kcmil | 400 G,H,I,K,M FLEX 444.4 DLO | 600kcmil - 250kcmil | 3/8 | 0.406 | 1.000 | 1.937 | 1.375 | 4.121 | 1.712 | 0.414 | Green | I-94 | 1.187 | 0.920 |
| CSWD-600-12-134 | 600kcmil | 400 G,H,I,K,M FLEX 444.4 DLO | 600kcmil - 250kcmil | 1/2 | 0.562 | 1.750 | 3.000 | 1.375 | 5.184 | 1.712 | 0.546 | Green | I-94 | 1.187 | 0.920 |
| CSWD-650-12-134 | 650kcmil | 500 G,H,I,K,M FLEX 535.3 DLO | 650kcmil - 350kcmil | 1/2 | 0.562 | 1.750 | 3.000 | 1.375 | 5.244 | 1.764 | 0.546 | Pink | I-99 | 1.217 | 0.958 |
| CSWD-650-12-114 | 650kcmil | 500 G,H,I,K,M FLEX 535.3 DLO | 650kcmil - 350kcmil | 1/2 | 0.562 | 1.250 | 2.500 | 1.375 | 4.744 | 1.764 | 0.546 | Pink | I-99 | 1.217 | 0.958 |
| CSWD-650-38-1 | 650kcmil | 500 G,H,I,K,M FLEX 535.3 DLO | 650kcmil - 350kcmil | 3/8 | 0.406 | 1.000 | 1.937 | 1.375 | 4.181 | 1.764 | 0.414 | Pink | I-99 | 1.217 | 0.958 |
| CSWD-650-38-118 | 650kcmil | 500 G,H,I,K,M FLEX 535.3 DLO | 650kcmil - 350kcmil | 3/8 | 0.406 | 1.125 | 2.125 | 1.375 | 4.369 | 1.764 | 0.414 | Pink | I-99 | 1.217 | 0.958 |
| CSWD-650-516-1 | 650kcmil | 500 G,H,I,K,M FLEX 535.3 DLO | 650kcmil - 350kcmil | 1/32 | 0.343 | 1.000 | 1.937 | 1.375 | 4.181 | 1.764 | 0.352 | Pink | I-99 | 1.217 | 0.958 |
| CSWD-700-38-1 | 700kcmil | 500 G,H,I,K,M FLEX 535.3 DLO | 700kcmil - 350kcmil | 3/8 | 0.406 | 1.000 | 1.937 | 1.375 | 4.181 | 1.816 | 0.414 | Pink | I-99 | 1.250 | 0.991 |
| CSWD-700-12-114 | 700kcmil | 500 G,H,I,K,M FLEX 535.3 DLO | 700kcmil - 350kcmil | 1/2 | 0.562 | 1.250 | 2.500 | 1.375 | 4.744 | 1.816 | 0.546 | Pink | I-99 | 1.250 | 0.991 |
| CSWD-700-12-134 | 700kcmil | 500 G,H,I,K,M FLEX 535.3 DLO | 700kcmil - 350kcmil | 1/2 | 0.562 | 1.750 | 3.000 | 1.375 | 5.244 | 1.816 | 0.546 | Pink | I-99 | 1.250 | 0.991 |
| CSWD-700-12-178 | 700kcmil | 500 G,H,I,K,M FLEX 535.3 DLO | 700kcmil - 350kcmil | 1/2 | 0.562 | 1.875 | 3.000 | 1.375 | 5.244 | 1.816 | 0.546 | Pink | I-99 | 1.250 | 0.991 |
| CSWD-750-38-1 | 750kcmil | 600 G,H,I,M FLEX 646.4 DLO | 750kcmil - 500kcmil | 3/8 | 0.406 | 1.000 | 1.937 | 1.500 | 4.339 | 1.901 | 0.414 | Black | I-106 | 1.313 | 1.031 |
| CSWD-750-38-118 | 750kcmil | 600 G,H,I,M FLEX 646.4 DLO | 750kcmil - 500kcmil | 3/8 | 0.406 | 1.125 | 2.125 | 1.500 | 4.527 | 1.901 | 0.414 | Black | I-106 | 1.313 | 1.031 |
| CSWD-750-12-112 | 750kcmil | 600 G,H,I,M FLEX 646.4 DLO | 750kcmil - 500kcmil | 1/2 | 0.562 | 1.500 | 2.625 | 1.500 | 5.027 | 1.901 | 0.546 | Black | I-106 | 1.313 | 1.031 |
| CSWD-750-12-134 | 750kcmil | 600 G,H,I,M FLEX 646.4 DLO | 750kcmil - 500kcmil | 1/2 | 0.562 | 1.750 | 3.000 | 1.500 | 5.402 | 1.901 | 0.546 | Black | I-106 | 1.313 | 1.031 |
| CSWD-750-58-112 | 750kcmil | 600 G,H,I,M FLEX 646.4 DLO | 750kcmil - 500kcmil | 5/8 | 0.656 | 1.500 | 3.000 | 1.500 | 5.402 | 1.901 | 0.671 | Black | I-106 | 1.313 | 1.031 |
| CSWD-1000-38-1 | 1000kcmil | 750 G,H,I FLEX 777.7 DLO | 1000kcmil - 750kcmil | 3/8 | 0.406 | 1.000 | 1.937 | 1.625 | 4.587 | 2.169 | 0.414 | White | I-125 | 1.500 | 1.172 |
| CSWD-1000-12-114 | 1000kcmil | 750 G,H,I FLEX 777.7 DLO | 1000kcmil - 750kcmil | 1/2 | 0.562 | 1.250 | 2.500 | 1.625 | 5.150 | 2.169 | 0.546 | White | I-125 | 1.500 | 1.172 |
| CSWD-1000-12-134 | 1000kcmil | 750 G,H,I FLEX 777.7 DLO | 1000kcmil - 750kcmil | 1/2 | 0.562 | 1.750 | 3.000 | 1.625 | 5.650 | 2.169 | 0.546 | White | I-125 | 1.500 | 1.172 |
| CSWD-1000-58-112 | 1000kcmil | 750 G,H,I FLEX 777.7 DLO | 1000kcmil - 750kcmil | 5/8 | 0.656 | 1.500 | 3.000 | 1.625 | 5.650 | 2.169 | 0.671 | White | I-125 | 1.500 | 1.172 |

Tested to UL 486A/B, UL File E6207 All wire sizes, unless noted otherwise, are American Wire Gauge (AWG) * When installed with specified dieless tools See pages 80 to 90 for complete tooling information. For Bent Tangs change the 4th letter to a B and add "-4" for 45 deg. or "-9" for 90 deg.

SureCrimp Copper Compression Lugs

Long Barrel - 1 Hole, w/Sight Hole

Conductor Range: 1/0 - #8



A TYPE CLWS

Features

- Manufactured from high strength seamless copper tubing
- Electro-Tin plated
- Chamfered entry
- Color coded
- Suitable for use in circuits rated 35KV or less, proper high voltage spacing and insulation techniques must be used
- UL Listed and CSA Certified with nVent ILSCO and major competitor's compression tools
- UL467 Listed 500 kcmil - 10 AWG , #10 - #2 SOL
- For direct bury 500 kcmil - 10 grounding and bonding
- Rated to 90° C/194° F

Benefits

- Offers maximum conductivity and excellent crimping characteristics
- Provides low contact resistance
- For easy conductor insertion
- Identifies the proper compression die
- Application versatility

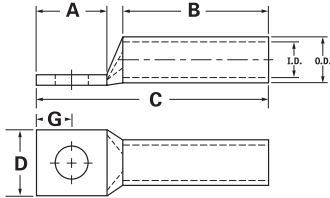

| Catalog Number | Wire Size | Alt Wire Size | Expanded* Wire Range | Bolt Size | Stud Hold Dia. | Dimensions (in.) | | | | | Die Color Code | Die Index | O.D. | I.D. |
|----------------|-----------|-----------------|----------------------|-----------|----------------|------------------|-------|-------|-------|-------|----------------|-----------|-------|-------|
| | | | | | | A | B | C | D | G | | | | |
| CLWS-8-10 | #8 AWG | #8 FLEX, #8 SOL | - | 10 | 0.219 | 0.562 | 0.812 | 1.569 | 0.374 | 0.258 | Red | I-21 | 0.272 | 0.179 |
| CLWS-8-14 | #8 AWG | #8 FLEX, #8 SOL | - | 1/4 | 0.281 | 0.680 | 0.812 | 1.687 | 0.486 | 0.320 | Red | I-21 | 0.272 | 0.179 |
| CLWS-8-516 | #8 AWG | #8 FLEX, #8 SOL | - | 5/16 | 0.343 | 0.875 | 0.812 | 1.882 | 0.532 | 0.352 | Red | I-21 | 0.272 | 0.179 |
| CLWS-8-38 | #8 AWG | #8 FLEX, #8 SOL | - | 3/8 | 0.406 | 0.875 | 0.812 | 1.882 | 0.593 | 0.414 | Red | I-21 | 0.272 | 0.179 |
| CLWS-6-10 | #6 AWG | #6 FLEX, #6 SOL | - | 10 | 0.219 | 0.562 | 1.125 | 1.882 | 0.440 | 0.258 | Blue | I-24 | 0.320 | 0.225 |
| CLWS-6-14 | #6 AWG | #6 FLEX, #6 SOL | - | 1/4 | 0.281 | 0.680 | 1.125 | 2.000 | 0.440 | 0.320 | Blue | I-24 | 0.320 | 0.225 |
| CLWS-6-516 | #6 AWG | #6 FLEX, #6 SOL | - | 5/16 | 0.343 | 0.875 | 1.125 | 2.195 | 0.530 | 0.352 | Blue | I-24 | 0.320 | 0.225 |
| CLWS-6-38 | #6 AWG | #6 FLEX, #6 SOL | - | 3/8 | 0.406 | 0.875 | 1.125 | 2.195 | 0.598 | 0.414 | Blue | I-24 | 0.320 | 0.225 |
| CLWS-6-12 | #6 AWG | #6 FLEX, #6 SOL | - | 1/2 | 0.562 | 1.250 | 1.125 | 2.570 | 0.755 | 0.546 | Blue | I-24 | 0.320 | 0.225 |
| CLWS-4-10 | #4 AWG | #4 SOL | 4-6 AWG | 10 | 0.219 | 0.562 | 1.125 | 1.921 | 0.486 | 0.258 | Gray | I-29 | 0.343 | 0.250 |
| CLWS-4-14 | #4 AWG | #4 SOL | 4-6 AWG | 1/4 | 0.281 | 0.680 | 1.125 | 2.039 | 0.486 | 0.320 | Gray | I-29 | 0.343 | 0.250 |
| CLWS-4-516 | #4 AWG | #4 SOL | 4-6 AWG | 5/16 | 0.343 | 0.875 | 1.125 | 2.234 | 0.486 | 0.352 | Gray | I-29 | 0.343 | 0.250 |
| CLWS-4-38 | #4 AWG | #4 SOL | 4-6 AWG | 3/8 | 0.406 | 0.875 | 1.125 | 2.234 | 0.593 | 0.414 | Gray | I-29 | 0.343 | 0.250 |
| CLWS-4-12 | #4 AWG | #4 SOL | 4-6 AWG | 1/2 | 0.562 | 1.250 | 1.125 | 2.609 | 0.750 | 0.546 | Gray | I-29 | 0.343 | 0.250 |
| CLWS-3-10 | #3 AWG | #4 FLEX | 3-6 AWG | 10 | 0.219 | 0.562 | 1.125 | 1.942 | 0.532 | 0.258 | White | I-29 | 0.375 | 0.275 |
| CLWS-3-14 | #3 AWG | #4 FLEX | 3-6 AWG | 1/4 | 0.281 | 0.680 | 1.125 | 2.060 | 0.532 | 0.320 | White | I-29 | 0.375 | 0.275 |
| CLWS-3-516 | #3 AWG | #4 FLEX | 3-6 AWG | 5/16 | 0.343 | 0.875 | 1.125 | 2.255 | 0.532 | 0.352 | White | I-29 | 0.375 | 0.275 |
| CLWS-3-38 | #3 AWG | #4 FLEX | 3-6 AWG | 3/8 | 0.406 | 0.875 | 1.125 | 2.255 | 0.593 | 0.414 | White | I-29 | 0.375 | 0.275 |
| CLWS-3-12 | #3 AWG | #4 FLEX | 3-6 AWG | 1/2 | 0.562 | 1.250 | 1.125 | 2.630 | 0.750 | 0.546 | White | I-29 | 0.375 | 0.275 |
| CLWS-2-10 | #2 AWG | #2 SOL | 2-6 AWG | 10 | 0.219 | 0.562 | 1.125 | 1.973 | 0.599 | 0.258 | Brown | I-33 | 0.421 | 0.312 |
| CLWS-2-14 | #2 AWG | #2 SOL | 2-6 AWG | 1/4 | 0.281 | 0.680 | 1.125 | 2.091 | 0.599 | 0.320 | Brown | I-33 | 0.421 | 0.312 |
| CLWS-2-516 | #2 AWG | #2 SOL | 2-6 AWG | 5/16 | 0.343 | 0.875 | 1.125 | 2.286 | 0.599 | 0.352 | Brown | I-33 | 0.421 | 0.312 |
| CLWS-2-38 | #2 AWG | #2 SOL | 2-6 AWG | 3/8 | 0.406 | 0.875 | 1.125 | 2.286 | 0.599 | 0.414 | Brown | I-33 | 0.421 | 0.312 |
| CLWS-2-12 | #2 AWG | #2 SOL | 2-6 AWG | 1/2 | 0.562 | 1.250 | 1.125 | 2.661 | 0.750 | 0.546 | Brown | I-33 | 0.421 | 0.312 |
| CLWS-1-10 | #1 AWG | #2 FLEX | 1-6 AWG | 10 | 0.219 | 0.562 | 1.375 | 2.267 | 0.673 | 0.258 | Green | I-37 | 0.468 | 0.359 |
| CLWS-1-14 | #1 AWG | #2 FLEX | 1-6 AWG | 1/4 | 0.281 | 0.875 | 1.375 | 2.580 | 0.673 | 0.320 | Green | I-37 | 0.468 | 0.359 |
| CLWS-1-516 | #1 AWG | #2 FLEX | 1-6 AWG | 5/16 | 0.343 | 0.875 | 1.375 | 2.580 | 0.673 | 0.352 | Green | I-37 | 0.468 | 0.359 |
| CLWS-1-38 | #1 AWG | #2 FLEX | 1-6 AWG | 3/8 | 0.406 | 0.875 | 1.375 | 2.580 | 0.673 | 0.414 | Green | I-37 | 0.468 | 0.359 |
| CLWS-1-12 | #1 AWG | #2 FLEX | 1-6 AWG | 1/2 | 0.562 | 1.250 | 1.375 | 2.955 | 0.750 | 0.546 | Green | I-37 | 0.468 | 0.359 |
| CLWS-1/0-10 | 1/0 AWG | #1 FLEX | 1/0-6 AWG | 10 | 0.219 | 0.562 | 1.500 | 2.418 | 0.738 | 0.258 | Pink | I-42 | 0.515 | 0.390 |
| CLWS-1/0-14 | 1/0 AWG | #1 FLEX | 1/0-6 AWG | 1/4 | 0.281 | 0.875 | 1.500 | 2.731 | 0.738 | 0.320 | Pink | I-42 | 0.515 | 0.390 |
| CLWS-1/0-516 | 1/0 AWG | #1 FLEX | 1/0-6 AWG | 5/16 | 0.343 | 0.875 | 1.500 | 2.731 | 0.738 | 0.352 | Pink | I-42 | 0.515 | 0.390 |
| CLWS-1/0-38 | 1/0 AWG | #1 FLEX | 1/0-6 AWG | 3/8 | 0.406 | 0.875 | 1.500 | 2.731 | 0.738 | 0.414 | Pink | I-42 | 0.515 | 0.390 |
| CLWS-1/0-12 | 1/0 AWG | #1 FLEX | 1/0-6 AWG | 1/2 | 0.562 | 1.250 | 1.500 | 3.106 | 0.738 | 0.546 | Pink | I-42 | 0.515 | 0.390 |

Tested to UL 486A/B, UL File E6207

All wire sizes, unless noted otherwise, are American Wire Gauge (AWG)

* When installed with specified dieless tools See pages 80 to 90 for complete tooling information.

For Bent Tangs change the 4th letter to a B and add "4" for 45 deg. or "9" for 90 deg.

SureCrimp Copper Compression Lugs

Long Barrel - 1 Hole, w/Sight Hole

Conductor Range: 400kcmil - 2/0



TYPE CLWS

Features

- Manufactured from high strength seamless copper tubing
- Electro-Tin plated
- Chamfered entry
- Color coded
- Suitable for use in circuits rated 35KV or less, proper high voltage spacing and insulation techniques must be used
- UL Listed and CSA Certified with nVent ILSCO and major competitor's compression tools
- UL467 Listed 500 kcmil - 10 AWG , #10 - #2 SOL
- For direct bury 500 kcmil - 10 grounding and bonding
- Rated to 90° C/194° F

Benefits

- Offers maximum conductivity and excellent crimping characteristics
- Provides low contact resistance
- For easy conductor insertion
- Identifies the proper compression die
- Application versatility

A

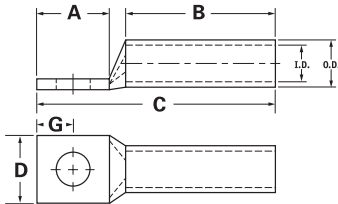

| Catalog Number | Wire Size | Alt Wire Size | Expanded* Wire Range | Bolt Size | Stud Hold Dia. | Dimensions (in.) | | | | | Die Color Code | Die Index | O.D. | I.D. |
|----------------|-----------|--------------------|------------------------------|-----------|----------------|------------------|-------|-------|-------|-------|----------------|-----------|-------|-------|
| | | | | | | A | B | C | D | G | | | | |
| CLWS-2/0-10 | 2/0 AWG | 1/0 FLEX | 2/0-4 AWG | 10 | 0.219 | 0.562 | 1.500 | 2.458 | 0.811 | 0.258 | Black | I-45 | 0.562 | 0.437 |
| CLWS-2/0-14 | 2/0 AWG | 1/0 FLEX | 2/0-4 AWG | 1/4 | 0.281 | 0.875 | 1.500 | 2.771 | 0.811 | 0.320 | Black | I-45 | 0.562 | 0.437 |
| CLWS-2/0-516 | 2/0 AWG | 1/0 FLEX | 2/0-4 AWG | 5/16 | 0.343 | 0.875 | 1.500 | 2.771 | 0.811 | 0.352 | Black | I-45 | 0.562 | 0.437 |
| CLWS-2/0-38 | 2/0 AWG | 1/0 FLEX | 2/0-4 AWG | 3/8 | 0.406 | 0.875 | 1.500 | 2.771 | 0.811 | 0.414 | Black | I-45 | 0.562 | 0.437 |
| CLWS-2/0-12 | 2/0 AWG | 1/0 FLEX | 2/0-4 AWG | 1/2 | 0.562 | 1.250 | 1.500 | 3.146 | 0.811 | 0.546 | Black | I-45 | 0.562 | 0.437 |
| CLWS-3/0-10 | 3/0 AWG | 2/0 FLEX | 3/0-2 AWG | 10 | 0.219 | 0.562 | 1.500 | 2.501 | 0.885 | 0.258 | Orange | I-50 | 0.609 | 0.484 |
| CLWS-3/0-14 | 3/0 AWG | 2/0 FLEX | 3/0-2 AWG | 1/4 | 0.281 | 0.875 | 1.500 | 2.814 | 0.885 | 0.320 | Orange | I-50 | 0.609 | 0.484 |
| CLWS-3/0-516 | 3/0 AWG | 2/0 FLEX | 3/0-2 AWG | 5/16 | 0.343 | 0.875 | 1.500 | 2.814 | 0.885 | 0.352 | Orange | I-50 | 0.609 | 0.484 |
| CLWS-3/0-38 | 3/0 AWG | 2/0 FLEX | 3/0-2 AWG | 3/8 | 0.406 | 0.875 | 1.500 | 2.814 | 0.885 | 0.414 | Orange | I-50 | 0.609 | 0.484 |
| CLWS-3/0-12 | 3/0 AWG | 2/0 FLEX | 3/0-2 AWG | 1/2 | 0.562 | 1.250 | 1.500 | 3.189 | 0.885 | 0.546 | Orange | I-50 | 0.609 | 0.484 |
| CLWS-4/0-14 | 4/0 AWG | 3/0 FLEX | 4/0-1 AWG | 1/4 | 0.281 | 0.875 | 1.500 | 2.866 | 0.999 | 0.320 | Purple | I-54 | 0.687 | 0.546 |
| CLWS-4/0-516 | 4/0 AWG | 3/0 FLEX | 4/0-1 AWG | 5/16 | 0.343 | 0.875 | 1.500 | 2.866 | 0.999 | 0.352 | Purple | I-54 | 0.687 | 0.546 |
| CLWS-4/0-38 | 4/0 AWG | 3/0 FLEX | 4/0-1 AWG | 3/8 | 0.406 | 0.875 | 1.500 | 2.866 | 0.999 | 0.414 | Purple | I-54 | 0.687 | 0.546 |
| CLWS-4/0-12 | 4/0 AWG | 3/0 FLEX | 4/0-1 AWG | 1/2 | 0.562 | 1.250 | 1.500 | 3.241 | 0.999 | 0.546 | Purple | I-54 | 0.687 | 0.546 |
| CLWS-250-516 | 250kcmil | 4/0 FLEX | 250kcmil - 1/0 AWG | 5/16 | 0.343 | 0.875 | 1.688 | 3.094 | 1.088 | 0.352 | Yellow | I-62 | 0.750 | 0.593 |
| CLWS-250-38 | 250kcmil | 4/0 FLEX | 250kcmil - 1/0 AWG | 3/8 | 0.406 | 0.875 | 1.688 | 3.094 | 1.088 | 0.414 | Yellow | I-62 | 0.750 | 0.593 |
| CLWS-250-12 | 250kcmil | 4/0 FLEX | 250kcmil - 1/0 AWG | 1/2 | 0.562 | 1.250 | 1.688 | 3.469 | 1.088 | 0.546 | Yellow | I-62 | 0.750 | 0.593 |
| CLWS-300-516 | 300kcmil | 250 G,H FLEX | 300kcmil - 2/0 AWG | 5/16 | 0.343 | 0.875 | 2.000 | 3.462 | 1.189 | 0.352 | White | I-66 | 0.812 | 0.660 |
| CLWS-300-38 | 300kcmil | 250 G,H FLEX | 300kcmil - 2/0 AWG | 3/8 | 0.406 | 0.875 | 2.000 | 3.462 | 1.189 | 0.414 | White | I-66 | 0.812 | 0.660 |
| CLWS-300-12 | 300kcmil | 250 G,H FLEX | 300kcmil - 2/0 AWG | 1/2 | 0.562 | 1.250 | 2.000 | 3.837 | 1.189 | 0.546 | White | I-66 | 0.812 | 0.660 |
| CLWS-350-38 | 350kcmil | 250 I,K,M FLEX | 350kcmil - 3/0 AWG 262.2 DLO | 3/8 | 0.406 | 0.875 | 2.000 | 3.498 | 1.291 | 0.414 | Red | I-71 | 0.890 | 0.703 |
| CLWS-350-12 | 350kcmil | 250 I,K,M FLEX | 350kcmil - 3/0 AWG 262.2 DLO | 1/2 | 0.562 | 1.250 | 2.000 | 3.873 | 1.291 | 0.546 | Red | I-71 | 0.890 | 0.703 |
| CLWS-350-38 | 350kcmil | 250 I,K,M FLEX | 350kcmil - 3/0 AWG 262.2 DLO | 3/8 | 0.406 | 0.875 | 2.000 | 3.498 | 1.291 | 0.414 | Red | I-71 | 0.890 | 0.703 |
| CLWS-350-12 | 350kcmil | 250 I,K,M FLEX | 350kcmil - 3/0 AWG 262.2 DLO | 1/2 | 0.562 | 1.250 | 2.000 | 3.873 | 1.291 | 0.546 | Red | I-71 | 0.890 | 0.703 |
| CLWS-350-58 | 350kcmil | 250 I,K,M FLEX | 350kcmil - 3/0 AWG 262.2 DLO | 5/8 | 0.656 | 1.437 | 2.000 | 4.060 | 1.291 | 0.671 | Red | I-71 | 0.890 | 0.703 |
| CLWS-400-38 | 400kcmil | 300 G,H,I,K,M FLEX | 400kcmil - 4/0 AWG 313.1 DLO | 3/8 | 0.406 | 0.875 | 2.125 | 3.667 | 1.365 | 0.414 | Blue | I-76 | 0.937 | 0.750 |
| CLWS-400-12 | 400kcmil | 300 G,H,I,K,M FLEX | 400kcmil - 4/0 AWG 313.1 DLO | 1/2 | 0.562 | 1.250 | 2.125 | 4.042 | 1.365 | 0.546 | Blue | I-76 | 0.937 | 0.750 |
| CLWS-400-58 | 400kcmil | 300 G,H,I,K,M FLEX | 400kcmil - 4/0 AWG 313.1 DLO | 5/8 | 0.656 | 1.437 | 2.125 | 4.229 | 1.365 | 0.671 | Blue | I-76 | 0.937 | 0.750 |

Tested to UL 486A/B, UL File E6207 All wire sizes, unless noted otherwise, are American Wire Gauge (AWG) * When installed with specified dieless tools See pages 80 to 90 for complete tooling information. For Bent Tangs change the 4th letter to a B and add "4" for 45 deg. or "9" for 90 deg.

SureCrimp Copper Compression Lugs

Long Barrel - 1 Hole, w/Sight Hole

Conductor Range: 1000kcmil - 500kcmil



A TYPE CLWS

Features

- Manufactured from high strength seamless copper tubing
- Electro-Tin plated
- Chamfered entry
- Color coded
- Suitable for use in circuits rated 35KV or less, proper high voltage spacing and insulation techniques must be used
- UL Listed and CSA Certified with nVent ILSCO and major competitor's compression tools
- UL467 Listed 500 kcmil - 10 AWG , #10 - #2 SOL
- For direct bury 500 kcmil - 10 grounding and bonding
- Rated to 90° C/194° F

Benefits

- Offers maximum conductivity and excellent crimping characteristics
- Provides low contact resistance
- For easy conductor insertion
- Identifies the proper compression die
- Application versatility

| Catalog Number | Wire Size | Alt Wire Size | Expanded* Wire Range | Bolt Size | Stud Hold Dia. | Dimensions (in.) | | | | | Die Color Dode | Die Index | O.D. | I.D |
|----------------|-----------|------------------------------|----------------------|-----------|----------------|------------------|-------|-------|-------|-------|----------------|-----------|-------|-------|
| | | | | | | A | B | C | D | G | | | | |
| CLWS-500-38 | 500kcmil | 350 G,H,I,K,M FLEX 373.7 DLO | 500kcmil - 250kcmil | 3/8 | 0.406 | 0.875 | 2.250 | 3.857 | 1.535 | 0.414 | Brown | I-87 | 1.062 | 0.828 |
| CLWS-500-12 | 500kcmil | 350 G,H,I,K,M FLEX 373.7 DLO | 500kcmil - 250kcmil | 1/2 | 0.562 | 1.250 | 2.250 | 4.232 | 1.535 | 0.546 | Brown | I-87 | 1.062 | 0.828 |
| CLWS-500-58 | 500kcmil | 350 G,H,I,K,M FLEX 373.7 DLO | 500kcmil - 250kcmil | 5/8 | 0.656 | 1.437 | 2.250 | 4.419 | 1.535 | 0.671 | Brown | I-87 | 1.062 | 0.828 |
| CLWS-600-38 | 600kcmil | 400 G,H,I,K,M FLEX 444.4 DLO | 600kcmil - 250kcmil | 3/8 | 0.406 | 0.875 | 2.687 | 4.371 | 1.712 | 0.414 | Green | I-94 | 1.187 | 0.920 |
| CLWS-600-12 | 600kcmil | 400 G,H,I,K,M FLEX 444.4 DLO | 600kcmil - 250kcmil | 1/2 | 0.562 | 1.250 | 2.687 | 4.746 | 1.712 | 0.546 | Green | I-94 | 1.187 | 0.920 |
| CLWS-600-58 | 600kcmil | 400 G,H,I,K,M FLEX 444.4 DLO | 600kcmil - 250kcmil | 5/8 | 0.656 | 1.437 | 2.687 | 4.933 | 1.712 | 0.671 | Green | I-94 | 1.187 | 0.920 |
| CLWS-650-516 | 650kcmil | 500 G,H,I,K,M FLEX 535.3 DLO | 650kcmil - 350kcmil | 1/32 | 0.343 | 0.875 | 2.687 | 4.431 | 1.764 | 0.352 | Pink | I-99 | 1.217 | 0.958 |
| CLWS-650-38 | 650kcmil | 500 G,H,I,K,M FLEX 535.3 DLO | 650kcmil - 350kcmil | 3/8 | 0.406 | 0.875 | 2.687 | 4.431 | 1.764 | 0.414 | Pink | I-99 | 1.217 | 0.958 |
| CLWS-650-12 | 650kcmil | 500 G,H,I,K,M FLEX 535.3 DLO | 650kcmil - 350kcmil | 1/2 | 0.562 | 1.25 | 2.687 | 4.806 | 1.764 | 0.546 | Pink | I-99 | 1.217 | 0.958 |
| CLWS-650-58 | 650kcmil | 500 G,H,I,K,M FLEX 535.3 DLO | 650kcmil - 350kcmil | 5/8 | 0.656 | 1.437 | 2.687 | 4.993 | 1.764 | 0.671 | Pink | I-99 | 1.217 | 0.958 |
| CLWS-700-38 | 700kcmil | 500 G,H,I,K,M FLEX 535.3 DLO | 700kcmil - 350kcmil | 3/8 | 0.406 | 0.875 | 2.687 | 4.431 | 1.816 | 0.414 | Pink | I-99 | 1.250 | 0.991 |
| CLWS-700-12 | 700kcmil | 500 G,H,I,K,M FLEX 535.3 DLO | 700kcmil - 350kcmil | 1/2 | 0.562 | 1.250 | 2.687 | 4.806 | 1.816 | 0.546 | Pink | I-99 | 1.250 | 0.991 |
| CLWS-700-58 | 700kcmil | 500 G,H,I,K,M FLEX 535.3 DLO | 700kcmil - 350kcmil | 5/8 | 0.656 | 1.437 | 2.687 | 4.993 | 1.816 | 0.671 | Pink | I-99 | 1.250 | 0.991 |
| CLWS-750-38 | 750kcmil | 600 G,H,I,M FLEX 646.4 DLO | 750kcmil - 500kcmil | 3/8 | 0.406 | 0.875 | 2.875 | 4.652 | 1.901 | 0.414 | Black | I-106 | 1.313 | 1.031 |
| CLWS-750-12 | 750kcmil | 600 G,H,I,M FLEX 646.4 DLO | 750kcmil - 500kcmil | 1/2 | 0.562 | 1.250 | 2.875 | 5.027 | 1.901 | 0.546 | Black | I-106 | 1.313 | 1.031 |
| CLWS-750-58 | 750kcmil | 600 G,H,I,M FLEX 646.4 DLO | 750kcmil - 500kcmil | 5/8 | 0.656 | 1.437 | 2.875 | 5.214 | 1.901 | 0.671 | Black | I-106 | 1.313 | 1.031 |
| CLWS-1000-38 | 1000kcmil | 750 G,H,I FLEX 777.7 DLO | 1000kcmil - 750kcmil | 3/8 | 0.406 | 0.875 | 3.000 | 4.900 | 2.169 | 0.414 | White | I-125 | 1.500 | 1.172 |
| CLWS-1000-12 | 1000kcmil | 750 G,H,I FLEX 777.7 DLO | 1000kcmil - 750kcmil | 1/2 | 0.562 | 1.250 | 3.000 | 5.275 | 2.169 | 0.546 | White | I-125 | 1.500 | 1.172 |
| CLWS-1000-58 | 1000kcmil | 750 G,H,I FLEX 777.7 DLO | 1000kcmil - 750kcmil | 5/8 | 0.656 | 1.437 | 3.000 | 5.462 | 2.169 | 0.671 | White | I-125 | 1.500 | 1.172 |

Tested to UL 486A/B, UL File E6207

All wire sizes, unless noted otherwise, are American Wire Gauge (AWG) * When installed with specified dieless tools See pages 80 to 90 for complete tooling information.
For Bent Tangs change the 4th letter to a B and add "-4" for 45 deg. or "-9" for 90 deg.

SureCrimp Copper Compression Lugs

Long Barrel - 1 Hole, w/o Sight Hole

Conductor Range: 1/0 - #8



TYPE CLNS

Features

- Manufactured from high strength seamless copper tubing
- Electro-Tin plated
- Chamfered entry
- Color coded
- Suitable for use in circuits rated 35KV or less, proper high voltage spacing and insulation techniques must be used
- UL Listed and CSA Certified with nVent ILSCO and major competitor's compression tools
- UL467 Listed 500 kcmil - 10 AWG , #10 - #2 SOL
- For direct bury 500 kcmil - 10 grounding and bonding
- Rated to 90° C/194° F

Benefits

- Offers maximum conductivity and excellent crimping characteristics
- Provides low contact resistance
- For easy conductor insertion
- Identifies the proper compression die
- Application versatility

A

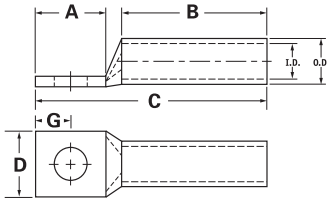

| Catalog Number | Wire Size | Alt Wire Size | Expanded* Wire Range | Bolt Size | Stud Hold Dia. | Dimensions (in.) | | | | | Die Color Code | Die Index | O.D. | I.D. |
|----------------|-----------|-----------------|----------------------|-----------|----------------|------------------|-------|-------|-------|-------|----------------|-----------|-------|-------|
| | | | | | | A | B | C | D | G | | | | |
| CLNS-8-10 | #8 AWG | #8 FLEX, #8 SOL | - | 10 | 0.219 | 0.562 | 0.812 | 1.569 | 0.374 | 0.258 | Red | I-21 | 0.272 | 0.179 |
| CLNS-8-14 | #8 AWG | #8 FLEX, #8 SOL | - | 1/4 | 0.281 | 0.680 | 0.812 | 1.687 | 0.486 | 0.320 | Red | I-21 | 0.272 | 0.179 |
| CLNS-8-516 | #8 AWG | #8 FLEX, #8 SOL | - | 5/16 | 0.343 | 0.875 | 0.812 | 1.882 | 0.532 | 0.352 | Red | I-21 | 0.272 | 0.179 |
| CLNS-8-38 | #8 AWG | #8 FLEX, #8 SOL | - | 3/8 | 0.406 | 0.875 | 0.812 | 1.882 | 0.593 | 0.414 | Red | I-21 | 0.272 | 0.179 |
| CLNS-6-10 | #6 AWG | #6 FLEX, #6 SOL | - | 10 | 0.219 | 0.562 | 1.125 | 1.882 | 0.440 | 0.258 | Blue | I-24 | 0.320 | 0.225 |
| CLNS-6-14 | #6 AWG | #6 FLEX, #6 SOL | - | 1/4 | 0.281 | 0.680 | 1.125 | 2.000 | 0.440 | 0.320 | Blue | I-24 | 0.320 | 0.225 |
| CLNS-6-516 | #6 AWG | #6 FLEX, #6 SOL | - | 5/16 | 0.343 | 0.875 | 1.125 | 2.195 | 0.530 | 0.352 | Blue | I-24 | 0.320 | 0.225 |
| CLNS-6-38 | #6 AWG | #6 FLEX, #6 SOL | - | 3/8 | 0.406 | 0.875 | 1.125 | 2.195 | 0.598 | 0.414 | Blue | I-24 | 0.320 | 0.225 |
| CLNS-6-12 | #6 AWG | #6 FLEX, #6 SOL | - | 1/2 | 0.562 | 1.250 | 1.125 | 2.570 | 0.755 | 0.546 | Blue | I-24 | 0.320 | 0.225 |
| CLNS-4-10 | #4 AWG | #4 SOL | 4-6 AWG | 10 | 0.219 | 0.562 | 1.125 | 1.921 | 0.486 | 0.258 | Gray | I-29 | 0.343 | 0.250 |
| CLNS-4-14 | #4 AWG | #4 SOL | 4-6 AWG | 1/4 | 0.281 | 0.680 | 1.125 | 2.039 | 0.486 | 0.320 | Gray | I-29 | 0.343 | 0.250 |
| CLNS-4-516 | #4 AWG | #4 SOL | 4-6 AWG | 5/16 | 0.343 | 0.875 | 1.125 | 2.234 | 0.486 | 0.352 | Gray | I-29 | 0.343 | 0.250 |
| CLNS-4-38 | #4 AWG | #4 SOL | 4-6 AWG | 3/8 | 0.406 | 0.875 | 1.125 | 2.234 | 0.593 | 0.414 | Gray | I-29 | 0.343 | 0.250 |
| CLNS-4-12 | #4 AWG | #4 SOL | 4-6 AWG | 1/2 | 0.562 | 1.250 | 1.125 | 2.609 | 0.750 | 0.546 | Gray | I-29 | 0.343 | 0.250 |
| CLNS-3-10 | #3 AWG | #4 FLEX | 3-6 AWG | 10 | 0.219 | 0.562 | 1.125 | 1.942 | 0.532 | 0.258 | White | I-29 | 0.375 | 0.275 |
| CLNS-3-14 | #3 AWG | #4 FLEX | 3-6 AWG | 1/4 | 0.281 | 0.680 | 1.125 | 2.060 | 0.532 | 0.320 | White | I-29 | 0.375 | 0.275 |
| CLNS-3-516 | #3 AWG | #4 FLEX | 3-6 AWG | 5/16 | 0.343 | 0.875 | 1.125 | 2.255 | 0.532 | 0.352 | White | I-29 | 0.375 | 0.275 |
| CLNS-3-38 | #3 AWG | #4 FLEX | 3-6 AWG | 3/8 | 0.406 | 0.875 | 1.125 | 2.255 | 0.593 | 0.414 | White | I-29 | 0.375 | 0.275 |
| CLNS-3-12 | #3 AWG | #4 FLEX | 3-6 AWG | 1/2 | 0.562 | 1.250 | 1.125 | 2.630 | 0.750 | 0.546 | White | I-29 | 0.375 | 0.275 |
| CLNS-2-10 | #2 AWG | #2 SOL | 2-6 AWG | 10 | 0.219 | 0.562 | 1.125 | 1.973 | 0.599 | 0.258 | Brown | I-33 | 0.421 | 0.312 |
| CLNS-2-14 | #2 AWG | #2 SOL | 2-6 AWG | 1/4 | 0.281 | 0.680 | 1.125 | 2.091 | 0.599 | 0.320 | Brown | I-33 | 0.421 | 0.312 |
| CLNS-2-516 | #2 AWG | #2 SOL | 2-6 AWG | 5/16 | 0.343 | 0.875 | 1.125 | 2.286 | 0.599 | 0.352 | Brown | I-33 | 0.421 | 0.312 |
| CLNS-2-38 | #2 AWG | #2 SOL | 2-6 AWG | 3/8 | 0.406 | 0.875 | 1.125 | 2.286 | 0.599 | 0.414 | Brown | I-33 | 0.421 | 0.312 |
| CLNS-2-12 | #2 AWG | #2 SOL | 2-6 AWG | 1/2 | 0.562 | 1.250 | 1.125 | 2.661 | 0.750 | 0.546 | Brown | I-33 | 0.421 | 0.312 |
| CLNS-1-10 | #1 AWG | #2 FLEX | 1-6 AWG | 10 | 0.219 | 0.562 | 1.375 | 2.267 | 0.673 | 0.258 | Green | I-37 | 0.468 | 0.359 |
| CLNS-1-14 | #1 AWG | #2 FLEX | 1-6 AWG | 1/4 | 0.281 | 0.875 | 1.375 | 2.580 | 0.673 | 0.320 | Green | I-37 | 0.468 | 0.359 |
| CLNS-1-516 | #1 AWG | #2 FLEX | 1-6 AWG | 5/16 | 0.343 | 0.875 | 1.375 | 2.580 | 0.673 | 0.352 | Green | I-37 | 0.468 | 0.359 |
| CLNS-1-38 | #1 AWG | #2 FLEX | 1-6 AWG | 3/8 | 0.406 | 0.875 | 1.375 | 2.580 | 0.673 | 0.414 | Green | I-37 | 0.468 | 0.359 |
| CLNS-1-12 | #1 AWG | #2 FLEX | 1-6 AWG | 1/2 | 0.562 | 1.250 | 1.375 | 2.955 | 0.750 | 0.546 | Green | I-37 | 0.468 | 0.359 |
| CLNS-1/0-10 | 1/0 AWG | #1 FLEX | 1/0-6 AWG | 10 | 0.219 | 0.562 | 1.500 | 2.418 | 0.738 | 0.258 | Pink | I-42 | 0.515 | 0.390 |
| CLNS-1/0-14 | 1/0 AWG | #1 FLEX | 1/0-6 AWG | 1/4 | 0.281 | 0.875 | 1.500 | 2.731 | 0.738 | 0.320 | Pink | I-42 | 0.515 | 0.390 |
| CLNS-1/0-516 | 1/0 AWG | #1 FLEX | 1/0-6 AWG | 5/16 | 0.343 | 0.875 | 1.500 | 2.731 | 0.738 | 0.352 | Pink | I-42 | 0.515 | 0.390 |
| CLNS-1/0-38 | 1/0 AWG | #1 FLEX | 1/0-6 AWG | 3/8 | 0.406 | 0.875 | 1.500 | 2.731 | 0.738 | 0.414 | Pink | I-42 | 0.515 | 0.390 |
| CLNS-1/0-12 | 1/0 AWG | #1 FLEX | 1/0-6 AWG | 1/2 | 0.562 | 1.250 | 1.500 | 3.106 | 0.738 | 0.546 | Pink | I-42 | 0.515 | 0.390 |

Tested to UL 486A/B, UL File E6207

All wire sizes, unless noted otherwise, are American Wire Gauge (AWG)

* When installed with specified dieless tools See pages 80 to 90 for complete tooling information.

For Bent Tangs change the 4th letter to a B and add "-4" for 45 deg. or "-9" for 90 deg.

SureCrimp Copper Compression Lugs

Long Barrel - 1 Hole, w/o Sight Hole

Conductor Range: 400kcmil - 1/0



A TYPE CLNS

Features

- Manufactured from high strength seamless copper tubing
- Electro-Tin plated
- Chamfered entry
- Color coded
- Suitable for use in circuits rated 35KV or less, proper high voltage spacing and insulation techniques must be used
- UL Listed and CSA Certified with nVent ILSCO and major competitor's compression tools
- UL467 Listed 500 kcmil - 10 AWG , #10 - #2 SOL
- For direct bury 500 kcmil - 10 grounding and bonding
- Rated to 90° C/194° F

Benefits

- Offers maximum conductivity and excellent crimping characteristics
- Provides low contact resistance
- For easy conductor insertion
- Identifies the proper compression die
- Application versatility

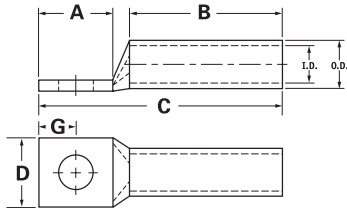

| Catalog Number | Wire Size | Alt Wire Size | Expanded* Wire Range | Bolt Size | Stud Hold Dia. | Dimensions (in.) | | | | | Die Color Code | Die Index | O.D. | I.D. |
|----------------|-----------|---------------------------------|----------------------|-----------|----------------|------------------|-------|-------|-------|-------|----------------|-----------|-------|-------|
| | | | | | | A | B | C | D | G | | | | |
| CLNS-2/0-10 | 2/0 AWG | 1/0 FLEX | 2/0-4 AWG | 10 | 0.219 | 0.562 | 1.500 | 2.458 | 0.811 | 0.258 | Black | I-45 | 0.562 | 0.437 |
| CLNS-2/0-14 | 2/0 AWG | 1/0 FLEX | 2/0-4 AWG | 1/4 | 0.281 | 0.875 | 1.500 | 2.771 | 0.811 | 0.320 | Black | I-45 | 0.562 | 0.437 |
| CLNS-2/0-516 | 2/0 AWG | 1/0 FLEX | 2/0-4 AWG | 5/16 | 0.343 | 0.875 | 1.500 | 2.771 | 0.811 | 0.352 | Black | I-45 | 0.562 | 0.437 |
| CLNS-2/0-38 | 2/0 AWG | 1/0 FLEX | 2/0-4 AWG | 3/8 | 0.406 | 0.875 | 1.500 | 2.771 | 0.811 | 0.414 | Black | I-45 | 0.562 | 0.437 |
| CLNS-2/0-12 | 2/0 AWG | 1/0 FLEX | 2/0-4 AWG | 1/2 | 0.562 | 1.250 | 1.500 | 3.146 | 0.811 | 0.546 | Black | I-45 | 0.562 | 0.437 |
| CLNS-3/0-10 | 3/0 AWG | 2/0 FLEX | 3/0-2 AWG | 10 | 0.219 | 0.562 | 1.500 | 2.501 | 0.885 | 0.258 | Orange | I-50 | 0.609 | 0.484 |
| CLNS-3/0-14 | 3/0 AWG | 2/0 FLEX | 3/0-2 AWG | 1/4 | 0.281 | 0.875 | 1.500 | 2.814 | 0.885 | 0.320 | Orange | I-50 | 0.609 | 0.484 |
| CLNS-3/0-516 | 3/0 AWG | 2/0 FLEX | 3/0-2 AWG | 5/16 | 0.343 | 0.875 | 1.500 | 2.814 | 0.885 | 0.352 | Orange | I-50 | 0.609 | 0.484 |
| CLNS-3/0-38 | 3/0 AWG | 2/0 FLEX | 3/0-2 AWG | 3/8 | 0.406 | 0.875 | 1.500 | 2.814 | 0.885 | 0.414 | Orange | I-50 | 0.609 | 0.484 |
| CLNS-3/0-12 | 3/0 AWG | 2/0 FLEX | 3/0-2 AWG | 1/2 | 0.562 | 1.250 | 1.500 | 3.189 | 0.885 | 0.546 | Orange | I-50 | 0.609 | 0.484 |
| CLNS-4/0-14 | 4/0 AWG | 3/0 FLEX | 4/0-1 AWG | 1/4 | 0.281 | 0.875 | 1.500 | 2.866 | 0.999 | 0.320 | Purple | I-54 | 0.687 | 0.546 |
| CLNS-4/0-516 | 4/0 AWG | 3/0 FLEX | 4/0-1 AWG | 5/16 | 0.343 | 0.875 | 1.500 | 2.866 | 0.999 | 0.352 | Purple | I-54 | 0.687 | 0.546 |
| CLNS-4/0-38 | 4/0 AWG | 3/0 FLEX | 4/0-1 AWG | 3/8 | 0.406 | 0.875 | 1.500 | 2.866 | 0.999 | 0.414 | Purple | I-54 | 0.687 | 0.546 |
| CLNS-4/0-12 | 4/0 AWG | 3/0 FLEX | 4/0-1 AWG | 1/2 | 0.562 | 1.250 | 1.500 | 3.241 | 0.999 | 0.546 | Purple | I-54 | 0.687 | 0.546 |
| CLNS-250-516 | 250kcmil | 4/0 FLEX | 250kcmil - 1/0 AWG | 5/16 | 0.343 | 0.875 | 1.688 | 3.094 | 1.088 | 0.352 | Yellow | I-62 | 0.750 | 0.593 |
| CLNS-250-38 | 250kcmil | 4/0 FLEX | 250kcmil - 1/0 AWG | 3/8 | 0.406 | 0.875 | 1.688 | 3.094 | 1.088 | 0.414 | Yellow | I-62 | 0.750 | 0.593 |
| CLNS-250-12 | 250kcmil | 4/0 FLEX | 250kcmil - 1/0 AWG | 1/2 | 0.562 | 1.250 | 1.688 | 3.469 | 1.088 | 0.546 | Yellow | I-62 | 0.750 | 0.593 |
| CLNS-300-516 | 300kcmil | 250 G,H FLEX | 300kcmil - 2/0 AWG | 5/16 | 0.343 | 0.875 | 2.000 | 3.462 | 1.189 | 0.352 | White | I-66 | 0.812 | 0.660 |
| CLNS-300-38 | 300kcmil | 250 G,H FLEX | 300kcmil - 2/0 AWG | 3/8 | 0.406 | 0.875 | 2.000 | 3.462 | 1.189 | 0.414 | White | I-66 | 0.812 | 0.660 |
| CLNS-300-12 | 300kcmil | 250 G,H FLEX | 300kcmil - 2/0 AWG | 1/2 | 0.562 | 1.250 | 2.000 | 3.837 | 1.189 | 0.546 | White | I-66 | 0.812 | 0.660 |
| CLNS-350-38 | 350kcmil | 250 I,K,M FLEX 262.2 DLO | 350kcmil - 3/0 AWG | 3/8 | 0.406 | 0.875 | 2.000 | 3.498 | 1.291 | 0.414 | Red | I-71 | 0.890 | 0.703 |
| CLNS-350-12 | 350kcmil | 250 I,K,M FLEX 262.2 DLO | 350kcmil - 3/0 AWG | 1/2 | 0.562 | 1.250 | 2.000 | 3.873 | 1.291 | 0.546 | Red | I-71 | 0.890 | 0.703 |
| CLNS-350-58 | 350kcmil | 250 I,K,M FLEX 262.2 DLO | 350kcmil - 3/0 AWG | 5/8 | 0.656 | 1.437 | 2.000 | 4.060 | 1.291 | 0.671 | Red | I-71 | 0.890 | 0.703 |
| CLNS-400-38 | 400kcmil | 300 G,H,I,K,M FLEX 313.1 DLO | 400kcmil - 4/0 AWG | 3/8 | 0.406 | 0.875 | 2.125 | 3.667 | 1.365 | 0.414 | Blue | I-76 | 0.937 | 0.750 |
| CLNS-400-12 | 400kcmil | 300 G,H,I,K,M FLEX 313.1 DLO | 400kcmil - 4/0 AWG | 1/2 | 0.562 | 1.250 | 2.125 | 4.042 | 1.365 | 0.546 | Blue | I-76 | 0.937 | 0.750 |
| CLNS-400-58 | 400kcmil | 300 G,H,I,K,M FLEX 313.1 DLO | 400kcmil - 4/0 AWG | 5/8 | 0.656 | 1.437 | 2.125 | 4.229 | 1.365 | 0.671 | Blue | I-76 | 0.937 | 0.750 |

Tested to UL 486A/B, UL File E6207

All wire sizes, unless noted otherwise, are American Wire Gauge (AWG)

* When installed with specified dieless tools See pages 80 to 90 for complete tooling information.

For Bent Tangs change the 4th letter to a B and add "-4" for 45 deg. or "-9" for 90 deg.

SureCrimp Copper Compression Lugs

Long Barrel - 1 Hole, w/o Sight Hole

Conductor Range: 1000kcmil - 500kcmil



TYPE CLNS

Features

- Manufactured from high strength seamless copper tubing
- Electro-Tin plated
- Chamfered entry
- Color coded
- Suitable for use in circuits rated 35KV or less, proper high voltage spacing and insulation techniques must be used
- UL Listed and CSA Certified with nVent ILSCO and major competitor's compression tools
- UL467 Listed 500 kcmil - 10 AWG, #10 - #2 SOL
- For direct bury 500 kcmil - 10 grounding and bonding
- Rated to 90° C/194° F

Benefits

- Offers maximum conductivity and excellent crimping characteristics
- Provides low contact resistance
- For easy conductor insertion
- Identifies the proper compression die
- Application versatility

A

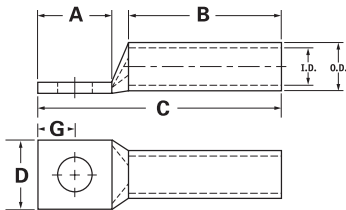

| Catalog Number | Wire Size | Alt Wire Size | Expanded* Wire Range | Bolt Size | Stud Hold Dia. | Dimensions (in.) | | | | | Die Color Code | Die Index | O.D. | I.D. |
|----------------|-----------|------------------------------|----------------------|-----------|----------------|------------------|-------|-------|-------|-------|----------------|-----------|-------|-------|
| | | | | | | A | B | C | D | G | | | | |
| CLNS-500-38 | 500kcmil | 350 G,H,I,K,M FLEX 373.7 DLO | 500kcmil - 250kcmil | 3/8 | 0.406 | 0.875 | 2.250 | 3.857 | 1.535 | 0.414 | Brown | I-87 | 1.062 | 0.828 |
| CLNS-500-12 | 500kcmil | 350 G,H,I,K,M FLEX 373.7 DLO | 500kcmil - 250kcmil | 1/2 | 0.562 | 1.250 | 2.250 | 4.232 | 1.535 | 0.546 | Brown | I-87 | 1.062 | 0.828 |
| CLNS-500-58 | 500kcmil | 350 G,H,I,K,M FLEX 373.7 DLO | 500kcmil - 250kcmil | 5/8 | 0.656 | 1.437 | 2.250 | 4.419 | 1.535 | 0.671 | Brown | I-87 | 1.062 | 0.828 |
| CLNS-600-38 | 600kcmil | 400 G,H,I,K,M FLEX 444.4 DLO | 600kcmil - 250kcmil | 3/8 | 0.406 | 0.875 | 2.687 | 4.371 | 1.712 | 0.414 | Green | I-94 | 1.187 | 0.920 |
| CLNS-600-12 | 600kcmil | 400 G,H,I,K,M FLEX 444.4 DLO | 600kcmil - 250kcmil | 1/2 | 0.562 | 1.250 | 2.687 | 4.746 | 1.712 | 0.546 | Green | I-94 | 1.187 | 0.920 |
| CLNS-600-58 | 600kcmil | 400 G,H,I,K,M FLEX 444.4 DLO | 600kcmil - 250kcmil | 5/8 | 0.656 | 1.437 | 2.687 | 4.933 | 1.712 | 0.671 | Green | I-94 | 1.187 | 0.920 |
| CLNS-650-516 | 650kcmil | 500 G,H,I,K,M FLEX 535.3 DLO | 650kcmil - 350kcmil | 1/32 | 0.343 | 0.875 | 2.687 | 4.431 | 1.764 | 0.352 | Pink | I-99 | 1.217 | 0.958 |
| CLNS-650-38 | 650kcmil | 500 G,H,I,K,M FLEX 535.3 DLO | 650kcmil - 350kcmil | 3/8 | 0.406 | 0.875 | 2.687 | 4.431 | 1.764 | 0.414 | Pink | I-99 | 1.217 | 0.958 |
| CLNS-650-12 | 650kcmil | 500 G,H,I,K,M FLEX 535.3 DLO | 650kcmil - 350kcmil | 1/2 | 0.562 | 1.250 | 2.687 | 4.806 | 1.764 | 0.546 | Pink | I-99 | 1.217 | 0.958 |
| CLNS-650-58 | 650kcmil | 500 G,H,I,K,M FLEX 535.3 DLO | 650kcmil - 350kcmil | 5/8 | 0.656 | 1.437 | 2.687 | 4.993 | 1.764 | 0.671 | Pink | I-99 | 1.217 | 0.958 |
| CLNS-700-38 | 700kcmil | 500 G,H,I,K,M FLEX 535.3 DLO | 700kcmil - 350kcmil | 3/8 | 0.406 | 0.875 | 2.687 | 4.431 | 1.816 | 0.414 | Pink | I-99 | 1.250 | 0.991 |
| CLNS-700-12 | 700kcmil | 500 G,H,I,K,M FLEX 535.3 DLO | 700kcmil - 350kcmil | 1/2 | 0.562 | 1.250 | 2.687 | 4.806 | 1.816 | 0.546 | Pink | I-99 | 1.250 | 0.991 |
| CLNS-700-58 | 700kcmil | 500 G,H,I,K,M FLEX 535.3 DLO | 700kcmil - 350kcmil | 5/8 | 0.656 | 1.437 | 2.687 | 4.993 | 1.816 | 0.671 | Pink | I-99 | 1.250 | 0.991 |
| CLNS-1000-38 | 1000kcmil | 750 G,H,I FLEX 777.7 DLO | 1000kcmil - 750kcmil | 3/8 | 0.406 | 0.875 | 3.000 | 4.900 | 2.169 | 0.414 | White | I-125 | 1.500 | 1.172 |
| CLNS-1000-12 | 1000kcmil | 750 G,H,I FLEX 777.7 DLO | 1000kcmil - 750kcmil | 1/2 | 0.562 | 1.250 | 3.000 | 5.275 | 2.169 | 0.546 | White | I-125 | 1.500 | 1.172 |
| CLNS-1000-58 | 1000kcmil | 750 G,H,I FLEX 777.7 DLO | 1000kcmil - 750kcmil | 5/8 | 0.656 | 1.437 | 3.000 | 5.462 | 2.169 | 0.671 | White | I-125 | 1.500 | 1.172 |

Tested to UL 486A/B, UL File E6207

All wire sizes, unless noted otherwise, are American Wire Gauge (AWG)

* When installed with specified dieless tools See pages 80 to 90 for complete tooling information.

For Bent Tangs change the 4th letter to a B and add "-4" for 45 deg. or "-9" for 90 deg.

SureCrimp Copper Compression Lugs

Long Barrel - 2 Hole, w/Sight Hole

Conductor Range: #4 - #8



A TYPE CLWD

Features

- Manufactured from high strength seamless copper tubing
- Electro-Tin plated
- Chamfered entry
- Color coded
- Suitable for use in circuits rated 35KV or less, proper high voltage spacing and insulation techniques must be used
- UL Listed and CSA Certified with nVent ILSCO and major competitor's compression tools
- UL467 Listed 500 kcmil - 10 AWG , #10 - #2 SOL
- For direct bury 500 kcmil - 10 grounding and bonding
- Rated to 90° C/194° F

Benefits

- Offers maximum conductivity and excellent crimping characteristics
- Provides low contact resistance
- For easy conductor insertion
- Identifies the proper compression die
- Application versatility

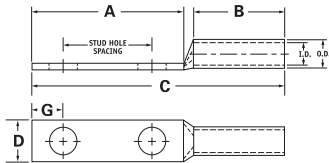

| Catalog Number | Wire Size | Alt Wire Size | Expanded* Wire Range | Bolt Size | Stud Hold Dia. | Stud Hole Spacing | Dimensions (in.) | | | | | Die Color Code | Die Index | O.D. | I.D |
|----------------|-----------|-----------------|----------------------|-----------|----------------|-------------------|------------------|-------|-------|-------|-------|----------------|-----------|-------|-------|
| | | | | | | | A | B | C | D | G | | | | |
| CLWD-8-10-58 | #8 AWG | #8 FLEX, #8 SOL | - | 10 | 0.219 | 0.625 | 1.250 | 0.812 | 2.257 | 0.374 | 0.258 | Red | I-21 | 0.272 | 0.179 |
| CLWD-8-10-34 | #8 AWG | #8 FLEX, #8 SOL | - | 10 | 0.219 | 0.750 | 1.437 | 0.812 | 2.444 | 0.374 | 0.258 | Red | I-21 | 0.272 | 0.179 |
| CLWD-8-14-58 | #8 AWG | #8 FLEX, #8 SOL | - | 1/4 | 0.281 | 0.625 | 1.437 | 0.812 | 2.444 | 0.486 | 0.320 | Red | I-21 | 0.272 | 0.179 |
| CLWD-8-14-34 | #8 AWG | #8 FLEX, #8 SOL | - | 1/4 | 0.281 | 0.750 | 1.437 | 0.812 | 2.444 | 0.486 | 0.320 | Red | I-21 | 0.272 | 0.179 |
| CLWD-8-14-1 | #8 AWG | #8 FLEX, #8 SOL | - | 1/4 | 0.281 | 1.000 | 1.687 | 0.812 | 2.694 | 0.486 | 0.320 | Red | I-21 | 0.272 | 0.179 |
| CLWD-8-38-1 | #8 AWG | #8 FLEX, #8 SOL | - | 3/8 | 0.406 | 1.000 | 1.937 | 0.812 | 2.944 | 0.593 | 0.414 | Red | I-21 | 0.272 | 0.179 |
| CLWD-6-10-12 | #6 AWG | #6 FLEX, #6 SOL | - | 10 | 0.219 | 0.500 | 1.250 | 1.125 | 2.570 | 0.440 | 0.258 | Blue | I-24 | 0.320 | 0.225 |
| CLWD-6-10-58 | #6 AWG | #6 FLEX, #6 SOL | - | 10 | 0.219 | 0.625 | 1.250 | 1.125 | 2.570 | 0.440 | 0.258 | Blue | I-24 | 0.320 | 0.225 |
| CLWD-6-10-1116 | #6 AWG | #6 FLEX, #6 SOL | - | 10 | 0.219 | 0.687 | 1.250 | 1.125 | 2.570 | 0.440 | 0.258 | Blue | I-24 | 0.320 | 0.225 |
| CLWD-6-10-34 | #6 AWG | #6 FLEX, #6 SOL | - | 10 | 0.219 | 0.750 | 1.437 | 1.125 | 2.757 | 0.440 | 0.258 | Blue | I-24 | 0.320 | 0.225 |
| CLWD-6-14-12 | #6 AWG | #6 FLEX, #6 SOL | - | 1/4 | 0.281 | 0.500 | 1.250 | 1.125 | 2.570 | 0.440 | 0.320 | Blue | I-24 | 0.320 | 0.225 |
| CLWD-6-14-58 | #6 AWG | #6 FLEX, #6 SOL | - | 1/4 | 0.281 | 0.625 | 1.437 | 1.125 | 2.757 | 0.440 | 0.320 | Blue | I-24 | 0.320 | 0.225 |
| CLWD-6-14-34 | #6 AWG | #6 FLEX, #6 SOL | - | 1/4 | 0.281 | 0.750 | 1.437 | 1.125 | 2.757 | 0.440 | 0.320 | Blue | I-24 | 0.320 | 0.225 |
| CLWD-6-14-1 | #6 AWG | #6 FLEX, #6 SOL | - | 1/4 | 0.281 | 1.000 | 1.687 | 1.125 | 3.007 | 0.440 | 0.320 | Blue | I-24 | 0.320 | 0.225 |
| CLWD-6-516-34 | #6 AWG | #6 FLEX, #6 SOL | - | 5/16 | 0.343 | 0.750 | 1.687 | 1.125 | 3.007 | 0.530 | 0.352 | Blue | I-24 | 0.320 | 0.225 |
| CLWD-6-516-1 | #6 AWG | #6 FLEX, #6 SOL | - | 5/16 | 0.343 | 1.000 | 1.937 | 1.125 | 3.257 | 0.530 | 0.352 | Blue | I-24 | 0.320 | 0.225 |
| CLWD-6-38-34 | #6 AWG | #6 FLEX, #6 SOL | - | 3/8 | 0.406 | 0.750 | 1.687 | 1.125 | 3.007 | 0.598 | 0.414 | Blue | I-24 | 0.320 | 0.225 |
| CLWD-6-38-78 | #6 AWG | #6 FLEX, #6 SOL | - | 3/8 | 0.406 | 0.875 | 1.937 | 1.125 | 3.257 | 0.598 | 0.414 | Blue | I-24 | 0.320 | 0.225 |
| CLWD-6-38-1 | #6 AWG | #6 FLEX, #6 SOL | - | 3/8 | 0.406 | 1.000 | 1.937 | 1.125 | 3.257 | 0.598 | 0.414 | Blue | I-24 | 0.320 | 0.225 |
| CLWD-6-12-134 | #6 AWG | #6 FLEX, #6 SOL | - | 1/2 | 0.562 | 1.750 | 3.000 | 1.125 | 4.320 | 0.755 | 0.546 | Blue | I-24 | 0.320 | 0.225 |
| CLWD-4-10-58 | #4 AWG | #4 SOL | 4-6 AWG | 10 | 0.219 | 0.625 | 1.250 | 1.125 | 2.609 | 0.486 | 0.258 | Gray | I-29 | 0.343 | 0.250 |
| CLWD-4-10-34 | #4 AWG | #4 SOL | 4-6 AWG | 10 | 0.219 | 0.750 | 1.437 | 1.125 | 2.796 | 0.486 | 0.258 | Gray | I-29 | 0.343 | 0.250 |
| CLWD-4-10-1 | #4 AWG | #4 SOL | 4-6 AWG | 10 | 0.219 | 1.000 | 1.687 | 1.125 | 3.046 | 0.486 | 0.258 | Gray | I-29 | 0.343 | 0.250 |
| CLWD-4-14-58 | #4 AWG | #4 SOL | 4-6 AWG | 1/4 | 0.281 | 0.625 | 1.437 | 1.125 | 2.796 | 0.486 | 0.320 | Gray | I-29 | 0.343 | 0.250 |
| CLWD-4-14-34 | #4 AWG | #4 SOL | 4-6 AWG | 1/4 | 0.281 | 0.750 | 1.437 | 1.125 | 2.796 | 0.486 | 0.320 | Gray | I-29 | 0.343 | 0.250 |
| CLWD-4-14-1 | #4 AWG | #4 SOL | 4-6 AWG | 1/4 | 0.281 | 1.000 | 1.687 | 1.125 | 3.046 | 0.486 | 0.320 | Gray | I-29 | 0.343 | 0.250 |
| CLWD-4-516-58 | #4 AWG | #4 SOL | 4-6 AWG | 5/16 | 0.343 | 0.625 | 1.437 | 1.125 | 2.796 | 0.486 | 0.352 | Gray | I-29 | 0.343 | 0.250 |
| CLWD-4-516-34 | #4 AWG | #4 SOL | 4-6 AWG | 5/16 | 0.343 | 0.750 | 1.687 | 1.125 | 3.046 | 0.486 | 0.352 | Gray | I-29 | 0.343 | 0.250 |
| CLWD-4-516-1 | #4 AWG | #4 SOL | 4-6 AWG | 5/16 | 0.343 | 1.000 | 1.937 | 1.125 | 3.296 | 0.486 | 0.352 | Gray | I-29 | 0.343 | 0.250 |
| CLWD-4-38-34 | #4 AWG | #4 SOL | 4-6 AWG | 3/8 | 0.406 | 0.750 | 1.687 | 1.125 | 3.046 | 0.593 | 0.414 | Gray | I-29 | 0.343 | 0.250 |
| CLWD-4-38-1 | #4 AWG | #4 SOL | 4-6 AWG | 3/8 | 0.406 | 1.000 | 1.937 | 1.125 | 3.296 | 0.593 | 0.414 | Gray | I-29 | 0.343 | 0.250 |
| CLWD-4-12-134 | #4 AWG | #4 SOL | 4-6 AWG | 1/2 | 0.562 | 1.750 | 3.000 | 1.125 | 4.359 | 0.750 | 0.546 | Gray | I-29 | 0.343 | 0.250 |

Tested to UL 486A/B, UL File E6207 All wire sizes, unless noted otherwise, are American Wire Gauge (AWG) * When installed with specified dieless tools See pages 80 to 90 for complete tooling information. For Bent Tangs change the 4th letter to a B and add "-4" for 45 deg. or "-9" for 90 deg.

SureCrimp Copper Compression Lugs

Long Barrel - 2 Hole, w/Sight Hole

Conductor Range: #1 - #3



TYPE CLWD

Features

- Manufactured from high strength seamless copper tubing
- Electro-Tin plated
- Chamfered entry
- Color coded
- Suitable for use in circuits rated 35KV or less, proper high voltage spacing and insulation techniques must be used
- UL Listed and CSA Certified with nVent ILSCO and major competitor's compression tools
- UL467 Listed 500 kcmil - 10 AWG , #10 - #2 SOL
- For direct bury 500 kcmil - 10 grounding and bonding
- Rated to 90° C/194° F

Benefits

- Offers maximum conductivity and excellent crimping characteristics
- Provides low contact resistance
- For easy conductor insertion
- Identifies the proper compression die
- Application versatility

A

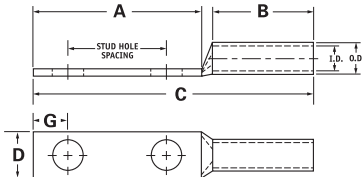

| Catalog Number | Wire Size | Alt Wire Size | Expanded* Wire Range | Bolt Size | Stud Hold Dia. | Stud Hole Spacing | Dimensions (in.) | | | | | Die Color Code | Die Index | O.D. | I.D. |
|----------------|-----------|---------------|----------------------|-----------|----------------|-------------------|------------------|-------|-------|-------|-------|----------------|-----------|-------|-------|
| | | | | | | | A | B | C | D | G | | | | |
| CLWD-3-14-58 | #3 AWG | #4 FLEX | 3-6 AWG | 1/4 | 0.281 | 0.625 | 1.437 | 1.125 | 2.817 | 0.532 | 0.320 | White | I-29 | 0.375 | 0.275 |
| CLWD-3-14-34 | #3 AWG | #4 FLEX | 3-6 AWG | 1/4 | 0.281 | 0.750 | 1.437 | 1.125 | 2.817 | 0.532 | 0.320 | White | I-29 | 0.375 | 0.275 |
| CLWD-3-516-58 | #3 AWG | #4 FLEX | 3-6 AWG | 5/16 | 0.343 | 0.625 | 1.437 | 1.125 | 2.817 | 0.532 | 0.352 | White | I-29 | 0.375 | 0.275 |
| CLWD-3-516-1 | #3 AWG | #4 FLEX | 3-6 AWG | 5/16 | 0.343 | 1.000 | 1.937 | 1.125 | 3.317 | 0.532 | 0.352 | White | I-29 | 0.375 | 0.275 |
| CLWD-3-38-34 | #3 AWG | #4 FLEX | 3-6 AWG | 3/8 | 0.406 | 0.750 | 1.687 | 1.125 | 3.067 | 0.593 | 0.414 | White | I-29 | 0.375 | 0.275 |
| CLWD-3-38-1 | #3 AWG | #4 FLEX | 3-6 AWG | 3/8 | 0.406 | 1.000 | 1.937 | 1.125 | 3.317 | 0.593 | 0.414 | White | I-29 | 0.375 | 0.275 |
| CLWD-3-12-134 | #3 AWG | #4 FLEX | 3-6 AWG | 1/2 | 0.562 | 1.750 | 3.000 | 1.125 | 4.380 | 0.750 | 0.546 | White | I-29 | 0.375 | 0.275 |
| CLWD-2-10-34 | #2 AWG | #2 SOL | 2-6 AWG | 10 | 0.219 | 0.750 | 1.437 | 1.125 | 2.848 | 0.599 | 0.258 | Brown | I-33 | 0.421 | 0.312 |
| CLWD-2-14-58 | #2 AWG | #2 SOL | 2-6 AWG | 1/4 | 0.281 | 0.625 | 1.437 | 1.125 | 2.848 | 0.599 | 0.320 | Brown | I-33 | 0.421 | 0.312 |
| CLWD-2-14-34 | #2 AWG | #2 SOL | 2-6 AWG | 1/4 | 0.281 | 0.750 | 1.437 | 1.125 | 2.848 | 0.599 | 0.320 | Brown | I-33 | 0.421 | 0.312 |
| CLWD-2-14-1 | #2 AWG | #2 SOL | 2-6 AWG | 1/4 | 0.281 | 1.000 | 1.687 | 1.125 | 3.098 | 0.599 | 0.320 | Brown | I-33 | 0.421 | 0.312 |
| CLWD-2-516-58 | #2 AWG | #2 SOL | 2-6 AWG | 5/16 | 0.343 | 0.625 | 1.687 | 1.125 | 3.098 | 0.599 | 0.352 | Brown | I-33 | 0.421 | 0.312 |
| CLWD-2-516-34 | #2 AWG | #2 SOL | 2-6 AWG | 5/16 | 0.343 | 0.750 | 1.687 | 1.125 | 3.098 | 0.599 | 0.352 | Brown | I-33 | 0.421 | 0.312 |
| CLWD-2-516-1 | #2 AWG | #2 SOL | 2-6 AWG | 5/16 | 0.343 | 1.000 | 1.937 | 1.125 | 3.348 | 0.599 | 0.352 | Brown | I-33 | 0.421 | 0.312 |
| CLWD-2-38-58 | #2 AWG | #2 SOL | 2-6 AWG | 3/8 | 0.406 | 0.625 | 1.687 | 1.125 | 3.098 | 0.599 | 0.414 | Brown | I-33 | 0.421 | 0.312 |
| CLWD-2-38-34 | #2 AWG | #2 SOL | 2-6 AWG | 3/8 | 0.406 | 0.750 | 1.687 | 1.125 | 3.098 | 0.599 | 0.414 | Brown | I-33 | 0.421 | 0.312 |
| CLWD-2-38-78 | #2 AWG | #2 SOL | 2-6 AWG | 3/8 | 0.406 | 0.875 | 1.937 | 1.125 | 3.348 | 0.599 | 0.414 | Brown | I-33 | 0.421 | 0.312 |
| CLWD-2-38-1 | #2 AWG | #2 SOL | 2-6 AWG | 3/8 | 0.406 | 1.000 | 1.937 | 1.125 | 3.348 | 0.599 | 0.414 | Brown | I-33 | 0.421 | 0.312 |
| CLWD-2-38-134 | #2 AWG | #2 SOL | 2-6 AWG | 3/8 | 0.406 | 1.750 | 2.625 | 1.125 | 4.036 | 0.599 | 0.414 | Brown | I-33 | 0.421 | 0.312 |
| CLWD-2-12-134 | #2 AWG | #2 SOL | 2-6 AWG | 1/2 | 0.562 | 1.750 | 3.000 | 1.125 | 4.411 | 0.750 | 0.546 | Brown | I-33 | 0.421 | 0.312 |
| CLWD-1-14-58 | #1 AWG | #2 FLEX | 1-6 AWG | 1/4 | 0.281 | 0.625 | 1.437 | 1.375 | 3.142 | 0.673 | 0.320 | Green | I-37 | 0.468 | 0.359 |
| CLWD-1-14-34 | #1 AWG | #2 FLEX | 1-6 AWG | 1/4 | 0.281 | 0.750 | 1.437 | 1.375 | 3.142 | 0.673 | 0.320 | Green | I-37 | 0.468 | 0.359 |
| CLWD-1-14-1 | #1 AWG | #2 FLEX | 1-6 AWG | 1/4 | 0.281 | 1.000 | 1.687 | 1.375 | 3.392 | 0.673 | 0.320 | Green | I-37 | 0.468 | 0.359 |
| CLWD-1-516-78 | #1 AWG | #2 FLEX | 1-6 AWG | 5/16 | 0.343 | 0.875 | 1.687 | 1.375 | 3.392 | 0.673 | 0.352 | Green | I-37 | 0.468 | 0.359 |
| CLWD-1-516-1 | #1 AWG | #2 FLEX | 1-6 AWG | 5/16 | 0.343 | 1.000 | 1.937 | 1.375 | 3.642 | 0.673 | 0.352 | Green | I-37 | 0.468 | 0.359 |
| CLWD-1-38-1 | #1 AWG | #2 FLEX | 1-6 AWG | 3/8 | 0.406 | 1.000 | 1.937 | 1.375 | 3.642 | 0.673 | 0.414 | Green | I-37 | 0.468 | 0.359 |
| CLWD-1-12-134 | #1 AWG | #2 FLEX | 1-6 AWG | 1/2 | 0.562 | 1.750 | 3.000 | 1.375 | 4.705 | 0.750 | 0.546 | Green | I-37 | 0.468 | 0.359 |

Tested to UL 486A/B, UL File E6207

All wire sizes, unless noted otherwise, are American Wire Gauge (AWG) * When installed with specified dieless tools See pages 80 to 90 for complete tooling information.
For Bent Tangs change the 4th letter to a B and add "-4" for 45 deg. or "-9" for 90 deg.

SureCrimp Copper Compression Lugs

Long Barrel - 2 Hole, w/Sight Hole

Conductor Range: 3/0 - 1/0



A TYPE CLWD

Features

- Manufactured from high strength seamless copper tubing
- Electro-Tin plated
- Chamfered entry
- Color coded
- Suitable for use in circuits rated 35KV or less, proper high voltage spacing and insulation techniques must be used
- UL Listed and CSA Certified with nVent ILSCO and major competitor's compression tools
- UL467 Listed 500 kcmil - 10 AWG , #10 - #2 SOL
- For direct bury 500 kcmil - 10 grounding and bonding
- Rated to 90° C/194° F

Benefits

- Offers maximum conductivity and excellent crimping characteristics
- Provides low contact resistance
- For easy conductor insertion
- Identifies the proper compression die
- Application versatility

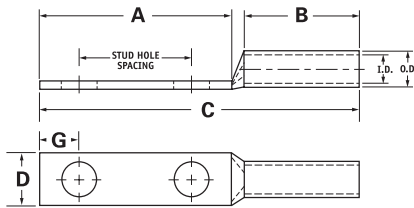

| Catalog Number | Wire Size | Alt Wire Size | Expanded* Wire Range | Bolt Size | Stud Hold Dia. | Stud Hole Spacing | Dimensions (in.) | | | | | Die Color Code | Die Index | O.D. | I.D. |
|-----------------|-----------|---------------|----------------------|-----------|----------------|-------------------|------------------|-------|-------|-------|-------|----------------|-----------|-------|-------|
| | | | | | | | A | B | C | D | G | | | | |
| CLWD-1/0-14-58 | 1/0 AWG | #1 FLEX | 1/0-6 AWG | 1/4 | 0.281 | 0.625 | 1.437 | 1.500 | 3.293 | 0.738 | 0.320 | Pink | I-42 | 0.515 | 0.390 |
| CLWD-1/0-14-34 | 1/0 AWG | #1 FLEX | 1/0-6 AWG | 1/4 | 0.281 | 0.750 | 1.437 | 1.500 | 3.293 | 0.738 | 0.320 | Pink | I-42 | 0.515 | 0.390 |
| CLWD-1/0-14-1 | 1/0 AWG | #1 FLEX | 1/0-6 AWG | 1/4 | 0.281 | 1.000 | 1.687 | 1.500 | 3.543 | 0.738 | 0.320 | Pink | I-42 | 0.515 | 0.390 |
| CLWD-1/0-516-34 | 1/0 AWG | #1 FLEX | 1/0-6 AWG | 5/16 | 0.343 | 0.750 | 1.687 | 1.500 | 3.543 | 0.738 | 0.352 | Pink | I-42 | 0.515 | 0.390 |
| CLWD-1/0-516-78 | 1/0 AWG | #1 FLEX | 1/0-6 AWG | 5/16 | 0.343 | 0.875 | 1.687 | 1.500 | 3.543 | 0.738 | 0.352 | Pink | I-42 | 0.515 | 0.390 |
| CLWD-1/0-516-1 | 1/0 AWG | #1 FLEX | 1/0-6 AWG | 5/16 | 0.343 | 1.000 | 1.937 | 1.500 | 3.793 | 0.738 | 0.352 | Pink | I-42 | 0.515 | 0.390 |
| CLWD-1/0-38-1 | 1/0 AWG | #1 FLEX | 1/0-6 AWG | 3/8 | 0.406 | 1.000 | 1.937 | 1.500 | 3.793 | 0.738 | 0.414 | Pink | I-42 | 0.515 | 0.390 |
| CLWD-1/0-38-134 | 1/0 AWG | #1 FLEX | 1/0-6 AWG | 3/8 | 0.406 | 1.750 | 2.625 | 1.500 | 4.481 | 0.738 | 0.414 | Pink | I-42 | 0.515 | 0.390 |
| CLWD-1/0-12-1 | 1/0 AWG | #1 FLEX | 1/0-6 AWG | 1/2 | 0.562 | 1.000 | 2.125 | 1.500 | 3.981 | 0.738 | 0.546 | Pink | I-42 | 0.515 | 0.390 |
| CLWD-1/0-12-134 | 1/0 AWG | #1 FLEX | 1/0-6 AWG | 1/2 | 0.562 | 1.750 | 3.000 | 1.500 | 4.856 | 0.738 | 0.546 | Pink | I-42 | 0.515 | 0.390 |
| CLWD-2/0-14-58 | 2/0 AWG | 1/0 FLEX | 2/0-4 AWG | 1/4 | 0.281 | 0.625 | 1.437 | 1.500 | 3.333 | 0.811 | 0.320 | Black | I-45 | 0.562 | 0.437 |
| CLWD-2/0-14-34 | 2/0 AWG | 1/0 FLEX | 2/0-4 AWG | 1/4 | 0.281 | 0.750 | 1.437 | 1.500 | 3.333 | 0.811 | 0.320 | Black | I-45 | 0.562 | 0.437 |
| CLWD-2/0-14-1 | 2/0 AWG | 1/0 FLEX | 2/0-4 AWG | 1/4 | 0.281 | 1.000 | 1.687 | 1.500 | 3.583 | 0.811 | 0.320 | Black | I-45 | 0.562 | 0.437 |
| CLWD-2/0-516-1 | 2/0 AWG | 1/0 FLEX | 2/0-4 AWG | 5/16 | 0.343 | 1.000 | 1.937 | 1.500 | 3.833 | 0.811 | 0.352 | Black | I-45 | 0.562 | 0.437 |
| CLWD-2/0-38-1 | 2/0 AWG | 1/0 FLEX | 2/0-4 AWG | 3/8 | 0.406 | 1.000 | 1.937 | 1.500 | 3.833 | 0.811 | 0.414 | Black | I-45 | 0.562 | 0.437 |
| CLWD-2/0-38-134 | 2/0 AWG | 1/0 FLEX | 2/0-4 AWG | 3/8 | 0.406 | 1.750 | 2.625 | 1.500 | 4.521 | 0.811 | 0.414 | Black | I-45 | 0.562 | 0.437 |
| CLWD-2/0-12-1 | 2/0 AWG | 1/0 FLEX | 2/0-4 AWG | 1/2 | 0.562 | 1.000 | 2.125 | 1.500 | 4.021 | 0.811 | 0.546 | Black | I-45 | 0.562 | 0.437 |
| CLWD-2/0-12-134 | 2/0 AWG | 1/0 FLEX | 2/0-4 AWG | 1/2 | 0.562 | 1.750 | 3.000 | 1.500 | 4.896 | 0.811 | 0.546 | Black | I-45 | 0.562 | 0.437 |
| CLWD-3/0-14-58 | 3/0 AWG | 2/0 FLEX | 3/0-2 AWG | 1/4 | 0.281 | 0.625 | 1.437 | 1.500 | 3.376 | 0.885 | 0.320 | Orange | I-50 | 0.609 | 0.484 |
| CLWD-3/0-14-34 | 3/0 AWG | 2/0 FLEX | 3/0-2 AWG | 1/4 | 0.281 | 0.750 | 1.437 | 1.500 | 3.376 | 0.885 | 0.320 | Orange | I-50 | 0.609 | 0.484 |
| CLWD-3/0-516-1 | 3/0 AWG | 2/0 FLEX | 3/0-2 AWG | 5/16 | 0.343 | 1.000 | 1.937 | 1.500 | 3.876 | 0.885 | 0.352 | Orange | I-50 | 0.609 | 0.484 |
| CLWD-3/0-38-1 | 3/0 AWG | 2/0 FLEX | 3/0-2 AWG | 3/8 | 0.406 | 1.000 | 1.937 | 1.500 | 3.876 | 0.885 | 0.414 | Orange | I-50 | 0.609 | 0.484 |
| CLWD-3/0-12-134 | 3/0 AWG | 2/0 FLEX | 3/0-2 AWG | 1/2 | 0.562 | 1.750 | 3.000 | 1.500 | 4.939 | 0.885 | 0.546 | Orange | I-50 | 0.609 | 0.484 |

Tested to UL 486A/B, UL File E6207

All wire sizes, unless noted otherwise, are American Wire Gauge (AWG) * When installed with specified dieless tools See pages 80 to 90 for complete tooling information.
For Bent Tangs change the 4th letter to a B and add "-4" for 45 deg. or "-9" for 90 deg.

SureCrimp Copper Compression Lugs

Long Barrel - 2 Hole, w/Sight Hole

Conductor Range: 300kcmil - 4/0



TYPE CLWD

Features

- Manufactured from high strength seamless copper tubing
- Electro-Tin plated
- Chamfered entry
- Color coded
- Suitable for use in circuits rated 35KV or less, proper high voltage spacing and insulation techniques must be used
- UL Listed and CSA Certified with nVent ILSCO and major competitor's compression tools
- UL467 Listed 500 kcmil - 10 AWG , #10 - #2 SOL
- For direct bury 500 kcmil - 10 grounding and bonding
- Rated to 90° C/194° F

Benefits

- Offers maximum conductivity and excellent crimping characteristics
- Provides low contact resistance
- For easy conductor insertion
- Identifies the proper compression die
- Application versatility

A

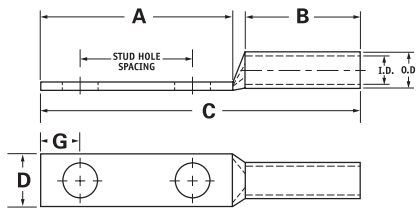

| Catalog Number | Wire Size | Alt Wire Size | Expanded* Wire Range | Bolt Size | Stud Hold Dia. | Stud Hole Spacing | Dimensions (in.) | | | | | Die Color Code | Die Index | O.D. | I.D. |
|------------------|-----------|---------------|----------------------|-----------|----------------|-------------------|------------------|-------|-------|-------|-------|----------------|-----------|-------|-------|
| | | | | | | | A | B | C | D | G | | | | |
| CLWD-4/0-14-58 | 4/0 AWG | 3/0 FLEX | 4/0-1 AWG | 1/4 | 0.281 | 0.625 | 1.437 | 1.500 | 3.428 | 0.999 | 0.320 | Purple | I-54 | 0.687 | 0.546 |
| CLWD-4/0-14-34 | 4/0 AWG | 3/0 FLEX | 4/0-1 AWG | 1/4 | 0.281 | 0.750 | 1.437 | 1.500 | 3.428 | 0.999 | 0.320 | Purple | I-54 | 0.687 | 0.546 |
| CLWD-4/0-14-1 | 4/0 AWG | 3/0 FLEX | 4/0-1 AWG | 1/4 | 0.281 | 1.000 | 1.687 | 1.500 | 3.678 | 0.999 | 0.320 | Purple | I-54 | 0.687 | 0.546 |
| CLWD-4/0-516-34 | 4/0 AWG | 3/0 FLEX | 4/0-1 AWG | 5/16 | 0.343 | 0.750 | 1.687 | 1.500 | 3.678 | 0.999 | 0.352 | Purple | I-54 | 0.687 | 0.546 |
| CLWD-4/0-516-1 | 4/0 AWG | 3/0 FLEX | 4/0-1 AWG | 5/16 | 0.343 | 1.000 | 1.937 | 1.500 | 3.928 | 0.999 | 0.352 | Purple | I-54 | 0.687 | 0.546 |
| CLWD-4/0-516-134 | 4/0 AWG | 3/0 FLEX | 4/0-1 AWG | 5/16 | 0.343 | 1.750 | 2.500 | 1.500 | 4.491 | 0.999 | 0.352 | Purple | I-54 | 0.687 | 0.546 |
| CLWD-4/0-38-1 | 4/0 AWG | 3/0 FLEX | 4/0-1 AWG | 3/8 | 0.406 | 1.000 | 1.937 | 1.500 | 3.928 | 0.999 | 0.414 | Purple | I-54 | 0.687 | 0.546 |
| CLWD-4/0-38-134 | 4/0 AWG | 3/0 FLEX | 4/0-1 AWG | 3/8 | 0.406 | 1.750 | 2.625 | 1.500 | 4.616 | 0.999 | 0.414 | Purple | I-54 | 0.687 | 0.546 |
| CLWD-4/0-12-1 | 4/0 AWG | 3/0 FLEX | 4/0-1 AWG | 1/2 | 0.562 | 1.000 | 2.125 | 1.500 | 4.116 | 0.999 | 0.546 | Purple | I-54 | 0.687 | 0.546 |
| CLWD-4/0-12-114 | 4/0 AWG | 3/0 FLEX | 4/0-1 AWG | 1/2 | 0.562 | 1.250 | 2.500 | 1.500 | 4.491 | 0.999 | 0.546 | Purple | I-54 | 0.687 | 0.546 |
| CLWD-4/0-12-134 | 4/0 AWG | 3/0 FLEX | 4/0-1 AWG | 1/2 | 0.562 | 1.750 | 3.000 | 1.500 | 4.991 | 0.999 | 0.546 | Purple | I-54 | 0.687 | 0.546 |
| CLWD-250-14-34 | 250kcmil | 4/0 FLEX | 250kcmil - 1/0 AWG | 1/4 | 0.281 | 0.750 | 1.437 | 1.688 | 3.656 | 1.088 | 0.320 | Yellow | I-62 | 0.750 | 0.593 |
| CLWD-250-38-1 | 250kcmil | 4/0 FLEX | 250kcmil - 1/0 AWG | 3/8 | 0.406 | 1.000 | 1.937 | 1.688 | 4.156 | 1.088 | 0.414 | Yellow | I-62 | 0.750 | 0.593 |
| CLWD-250-38-134 | 250kcmil | 4/0 FLEX | 250kcmil - 1/0 AWG | 3/8 | 0.406 | 1.750 | 2.625 | 1.688 | 4.844 | 1.088 | 0.414 | Yellow | I-62 | 0.750 | 0.593 |
| CLWD-250-12-114 | 250kcmil | 4/0 FLEX | 250kcmil - 1/0 AWG | 1/2 | 0.562 | 1.250 | 2.500 | 1.688 | 4.719 | 1.088 | 0.546 | Yellow | I-62 | 0.750 | 0.593 |
| CLWD-250-12-134 | 250kcmil | 4/0 FLEX | 250kcmil - 1/0 AWG | 1/2 | 0.562 | 1.750 | 3.000 | 1.688 | 5.219 | 1.088 | 0.546 | Yellow | I-62 | 0.750 | 0.593 |
| CLWD-300-38-1 | 300kcmil | 250 G,H FLEX | 300kcmil - 2/0 AWG | 3/8 | 0.406 | 1.000 | 1.937 | 2.000 | 4.524 | 1.189 | 0.414 | White | I-66 | 0.812 | 0.660 |
| CLWD-300-12-134 | 300kcmil | 250 G,H FLEX | 300kcmil - 2/0 AWG | 1/2 | 0.562 | 1.750 | 3.000 | 2.000 | 5.587 | 1.189 | 0.546 | White | I-66 | 0.812 | 0.660 |

Tested to UL 486A/B, UL File E6207

All wire sizes, unless noted otherwise, are American Wire Gauge (AWG)

* When installed with specified dieless tools See pages 80 to 90 for complete tooling information.

For Bent Tangs change the 4th letter to a B and add "-4" for 45 deg. or "-9" for 90 deg.

SureCrimp Copper Compression Lugs

Long Barrel - 2 Hole, w/Sight Hole

Conductor Range: 650kcmil - 350kcmil



A TYPE CLWD

Features

- Manufactured from high strength seamless copper tubing
- Electro-Tin plated
- Chamfered entry
- Color coded
- Suitable for use in circuits rated 35KV or less, proper high voltage spacing and insulation techniques must be used
- UL Listed and CSA Certified with nVent ILSCO and major competitor's compression tools
- UL467 Listed 500 kcmil - 10 AWG , #10 - #2 SOL
- For direct bury 500 kcmil - 10 grounding and bonding
- Rated to 90° C/194° F

Benefits

- Offers maximum conductivity and excellent crimping characteristics
- Provides low contact resistance
- For easy conductor insertion
- Identifies the proper compression die
- Application versatility

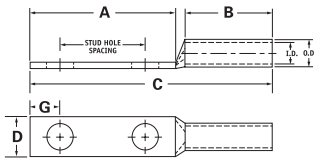

| Catalog Number | Wire Size | Alt Wire Size | Expanded* Wire Range | Bolt Size | Stud Hold Dia. | Stud Hole Spacing | Dimensions (in.) | | | | | Die Color Code | Die Index | O.D. | I.D. |
|------------------|-----------|------------------------------|----------------------|-----------|----------------|-------------------|------------------|-------|-------|-------|--------|----------------|-----------|-------|-------|
| | | | | | | | A | B | C | D | G | | | | |
| CLWD-350-14-34 | 350kcmil | 250 I,K,M FLEX 262.2 DLO | 350kcmil - 3/0 AWG | 1/4 | 0.281 | 0.750 | 1.437 | 2.000 | 4.060 | 1.291 | 0.320 | Red | I-71 | 0.890 | 0.703 |
| CLWD-350-516-134 | 350kcmil | 250 I,K,M FLEX 262.2 DLO | 350kcmil - 3/0 AWG | 5/16 | 0.343 | 1.750 | 2.500 | 2.000 | 5.123 | 1.291 | 0.352 | Red | I-71 | 0.890 | 0.703 |
| CLWD-350-38-1 | 350kcmil | 250 I,K,M FLEX 262.2 DLO | 350kcmil - 3/0 AWG | 3/8 | 0.406 | 1.000 | 1.937 | 2.000 | 4.560 | 1.291 | 0.414 | Red | I-71 | 0.890 | 0.703 |
| CLWD-350-12-114 | 350kcmil | 250 I,K,M FLEX 262.2 DLO | 350kcmil - 3/0 AWG | 1/2 | 0.562 | 1.250 | 2.500 | 2.000 | 5.123 | 1.291 | 0.546 | Red | I-71 | 0.890 | 0.703 |
| CLWD-350-12-134 | 350kcmil | 250 I,K,M FLEX 262.2 DLO | 350kcmil - 3/0 AWG | 1/2 | 0.562 | 1.750 | 3.000 | 2.000 | 5.623 | 1.291 | 0.546 | Red | I-71 | 0.890 | 0.703 |
| CLWD-400-38-1 | 400kcmil | 300 G,H,I,K,M FLEX 313.1 DLO | 400kcmil - 4/0 AWG | 3/8 | 0.406 | 1.000 | 1.937 | 2.125 | 4.729 | 1.365 | 0.414 | Blue | I-76 | 0.937 | 0.750 |
| CLWD-400-38-116 | 400kcmil | 300 G,H,I,K,M FLEX 313.1 DLO | 400kcmil - 4/0 AWG | 3/8 | 0.406 | 1.062 | 1.937 | 2.125 | 4.729 | 1.365 | 0.414 | Blue | I-76 | 0.937 | 0.750 |
| CLWD-400-12-134 | 400kcmil | 300 G,H,I,K,M FLEX 313.1 DLO | 400kcmil - 4/0 AWG | 1/2 | 0.562 | 1.750 | 3.000 | 2.125 | 5.792 | 1.365 | 0.546 | Blue | I-76 | 0.937 | 0.750 |
| CLWD-500-14-34 | 500kcmil | 350 G,H,I,K,M FLEX 373.7 DLO | 500kcmil - 250kcmil | 1/4 | 0.281 | 0.750 | 1.437 | 2.250 | 4.419 | 1.535 | 0.320 | Brown | I-87 | 1.062 | 0.828 |
| CLWD-500-12-114 | 500kcmil | 350 G,H,I,K,M FLEX 373.7 DLO | 500kcmil - 250kcmil | 1/2 | 0.562 | 1.250 | 2.500 | 2.250 | 5.482 | 1.535 | 0.546 | Brown | I-87 | 1.062 | 0.828 |
| CLWD-500-12-134 | 500kcmil | 350 G,H,I,K,M FLEX 373.7 DLO | 500kcmil - 250kcmil | 1/2 | 0.562 | 1.750 | 3.000 | 2.250 | 5.982 | 1.535 | 0.546 | Brown | I-87 | 1.062 | 0.828 |
| CLWD-600-38-1 | 600kcmil | 400 G,H,I,K,M FLEX 444.4 DLO | 600kcmil - 250kcmil | 3/8 | 0.406 | 1.000 | 1.937 | 2.687 | 5.433 | 1.712 | 0.414 | Green | I-94 | 1.187 | 0.920 |
| CLWD-600-12-134 | 600kcmil | 400 G,H,I,K,M FLEX 444.4 DLO | 600kcmil - 250kcmil | 1/2 | 0.562 | 1.750 | 3.000 | 2.687 | 6.496 | 1.712 | 0.546 | Green | I-94 | 1.187 | 0.920 |
| CLWD-650-12-114 | 650kcmil | 500 G,H,I,K,M FLEX 535.3 DLO | 650kcmil - 350kcmil | 1/2 | 0.562 | 1.250 | 2.500 | 2.687 | 6.056 | 1.764 | 0.546 | Pink | I-99 | 1.217 | 0.958 |
| CLWD-650-12-134 | 650kcmil | 500 G,H,I,K,M FLEX 535.3 DLO | 650kcmil - 350kcmil | 1/2 | 0.562 | 1.750 | 3.000 | 2.687 | 6.556 | 1.764 | 0.546 | Pink | I-99 | 1.217 | 0.958 |
| CLWD-650-38-1 | 650kcmil | 500 G,H,I,K,M FLEX 535.3 DLO | 650kcmil - 350kcmil | 3/8 | 0.406 | 1.000 | 1.937 | 2.687 | 5.493 | 1.764 | 0.414 | Pink | I-99 | 1.217 | 0.958 |
| CLWD-650-38-118 | 650kcmil | 500 G,H,I,K,M FLEX 535.3 DLO | 650kcmil - 350kcmil | 3/8 | 0.406 | 1.125 | 2.125 | 2.687 | 5.681 | 1.764 | 0.414 | Pink | I-99 | 1.217 | 0.958 |
| CLWD-650-516-1 | 650kcmil | 500 G,H,I,K,M FLEX 535.3 DLO | 650kcmil - 350kcmil | 1/32 | 0.343 | 1.000 | 1.937 | 2.687 | 5.493 | 1.764 | 0.3515 | Pink | I-99 | 1.217 | 0.958 |

Tested to UL 486A/B, UL File E6207 All wire sizes, unless noted otherwise, are American Wire Gauge (AWG) * When installed with specified dieless tools See pages 80 to 90 for complete tooling information. For Bent Tangs change the 4th letter to a B and add "-4" for 45 deg. or "-9" for 90 deg.

SureCrimp Copper Compression Lugs

Long Barrel - 2 Hole, w/Sight Hole

Conductor Range: 1000kcmil - 700kcmil



TYPE CLWD

Features

- Manufactured from high strength seamless copper tubing
- Electro-Tin plated
- Chamfered entry
- Color coded
- Suitable for use in circuits rated 35KV or less, proper high voltage spacing and insulation techniques must be used
- UL Listed and CSA Certified with nVent ILSCO and major competitor's compression tools
- UL467 Listed 500 kcmil - 10 AWG , #10 - #2 SOL
- For direct bury 500 kcmil - 10 grounding and bonding
- Rated to 90° C/194° F

Benefits

- Offers maximum conductivity and excellent crimping characteristics
- Provides low contact resistance
- For easy conductor insertion
- Identifies the proper compression die
- Application versatility

A

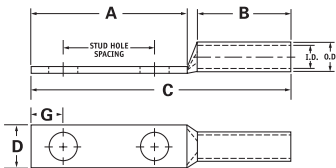

| Catalog Number | Wire Size | Alt Wire Size | Expanded* Wire Range | Bolt Size | Stud Hold Dia. | Stud Hole Spacing | Dimensions (in.) | | | | | Die Color Code | Die Index | O.D. | I.D. |
|------------------|-----------|------------------------------|----------------------|-----------|----------------|-------------------|------------------|-------|-------|-------|-------|----------------|-----------|-------|-------|
| | | | | | | | A | B | C | D | G | | | | |
| CLWD-700-38-1 | 700kcmil | 500 G,H,I,K,M FLEX 535.3 DLO | 700kcmil - 350kcmil | 3/8 | 0.406 | 1.000 | 1.937 | 2.687 | 5.493 | 1.816 | 0.414 | Pink | I-99 | 1.250 | 0.991 |
| CLWD-700-38-118 | 700kcmil | 500 G,H,I,K,M FLEX 535.3 DLO | 700kcmil - 350kcmil | 3/8 | 0.406 | 1.125 | 2.125 | 2.687 | 5.681 | 1.816 | 0.414 | Pink | I-99 | 1.250 | 0.991 |
| CLWD-700-12-112 | 700kcmil | 500 G,H,I,K,M FLEX 535.3 DLO | 700kcmil - 350kcmil | 1/2 | 0.562 | 1.500 | 2.625 | 2.687 | 6.181 | 1.816 | 0.546 | Pink | I-99 | 1.250 | 0.991 |
| CLWD-700-12-134 | 700kcmil | 500 G,H,I,K,M FLEX 535.3 DLO | 700kcmil - 350kcmil | 1/2 | 0.562 | 1.750 | 3.000 | 2.687 | 6.556 | 1.816 | 0.546 | Pink | I-99 | 1.250 | 0.991 |
| CLWD-700-12-178 | 700kcmil | 500 G,H,I,K,M FLEX 535.3 DLO | 700kcmil - 350kcmil | 1/2 | 0.562 | 1.875 | 3.000 | 2.687 | 6.556 | 1.816 | 0.546 | Pink | I-99 | 1.250 | 0.991 |
| CLWD-750-38-1 | 750kcmil | 600 G,H,I,M FLEX 646.4 DLO | 750kcmil - 500kcmil | 3/8 | 0.406 | 1.000 | 1.937 | 2.875 | 5.714 | 1.901 | 0.414 | Black | I-106 | 1.313 | 1.031 |
| CLWD-750-38-118 | 750kcmil | 600 G,H,I,M FLEX 646.4 DLO | 750kcmil - 500kcmil | 3/8 | 0.406 | 1.125 | 2.125 | 2.875 | 5.902 | 1.901 | 0.414 | Black | I-106 | 1.313 | 1.031 |
| CLWD-750-12-112 | 750kcmil | 600 G,H,I,M FLEX 646.4 DLO | 750kcmil - 500kcmil | 1/2 | 0.562 | 1.500 | 2.625 | 2.875 | 6.402 | 1.901 | 0.546 | Black | I-106 | 1.313 | 1.031 |
| CLWD-750-12-134 | 750kcmil | 600 G,H,I,M FLEX 646.4 DLO | 750kcmil - 500kcmil | 1/2 | 0.562 | 1.750 | 3.000 | 2.875 | 6.777 | 1.901 | 0.546 | Black | I-106 | 1.313 | 1.031 |
| CLWD-750-58-112 | 750kcmil | 600 G,H,I,M FLEX 646.4 DLO | 750kcmil - 500kcmil | 5/8 | 0.656 | 1.500 | 3.000 | 2.875 | 6.777 | 1.901 | 0.671 | Black | I-106 | 1.313 | 1.031 |
| CLWD-1000-38-1 | 1000kcmil | 750 G,H,I FLEX 777.7 DLO | 1000kcmil - 750kcmil | 3/8 | 0.406 | 1.000 | 1.937 | 3.000 | 5.962 | 2.169 | 0.414 | White | I-125 | 1.500 | 1.172 |
| CLWD-1000-12-114 | 1000kcmil | 750 G,H,I FLEX 777.7 DLO | 1000kcmil - 750kcmil | 1/2 | 0.562 | 1.250 | 2.500 | 3.000 | 6.525 | 2.169 | 0.546 | White | I-125 | 1.500 | 1.172 |
| CLWD-1000-12-134 | 1000kcmil | 750 G,H,I FLEX 777.7 DLO | 1000kcmil - 750kcmil | 1/2 | 0.562 | 1.750 | 3.000 | 3.000 | 7.025 | 2.169 | 0.546 | White | I-125 | 1.500 | 1.172 |
| CLWD-1000-58-112 | 1000kcmil | 750 G,H,I FLEX 777.7 DLO | 1000kcmil - 750kcmil | 5/8 | 0.656 | 1.500 | 3.000 | 3.000 | 7.025 | 2.169 | 0.671 | White | I-125 | 1.500 | 1.172 |

Tested to UL 486A/B, UL File E6207

All wire sizes, unless noted otherwise, are American Wire Gauge (AWG)

* When installed with specified dieless tools See pages 80 to 90 for complete tooling information.

For Bent Tangs change the 4th letter to a B and add "-4" for 45 deg. or "-9" for 90 deg.

SureCrimp Copper Compression Lugs

Long Barrel - 2 Hole, w/o Sight Hole

Conductor Range: #4 - #8



A TYPE CLND

Features

- Manufactured from high strength seamless copper tubing
- Electro-Tin plated
- Chamfered entry
- Color coded
- Suitable for use in circuits rated 35KV or less, proper high voltage spacing and insulation techniques must be used
- UL Listed and CSA Certified with nVent ILSCO and major competitor's compression tools
- UL467 Listed 500 kcmil - 10 AWG , #10 - #2 SOL
- For direct bury 500 kcmil - 10 grounding and bonding
- Rated to 90° C/194° F

Benefits

- Offers maximum conductivity and excellent crimping characteristics
- Provides low contact resistance
- For easy conductor insertion
- Identifies the proper compression die
- Application versatility

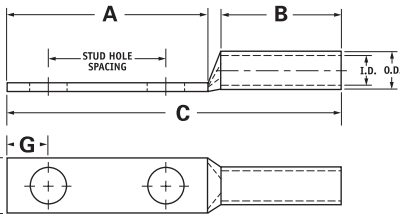

| Catalog Number | Wire Size | Alt Wire Size | Expanded* Wire Range | Bolt Size | Stud Hold Dia. | Stud Hole Spacing | Dimensions (in.) | | | | | Die Color Code | Die Index | O.D. | I.D. |
|----------------|-----------|-----------------|----------------------|-----------|----------------|-------------------|------------------|-------|-------|-------|-------|----------------|-----------|-------|-------|
| | | | | | | | A | B | C | D | G | | | | |
| CLND-8-10-58 | #8 AWG | #8 FLEX, #8 SOL | - | 10 | 0.219 | 0.625 | 1.250 | 0.812 | 2.257 | 0.374 | 0.258 | Red | I-21 | 0.272 | 0.179 |
| CLND-8-10-34 | #8 AWG | #8 FLEX, #8 SOL | - | 10 | 0.219 | 0.750 | 1.437 | 0.812 | 2.444 | 0.374 | 0.258 | Red | I-21 | 0.272 | 0.179 |
| CLND-8-14-58 | #8 AWG | #8 FLEX, #8 SOL | - | 1/4 | 0.281 | 0.625 | 1.437 | 0.812 | 2.444 | 0.486 | 0.320 | Red | I-21 | 0.272 | 0.179 |
| CLND-8-14-34 | #8 AWG | #8 FLEX, #8 SOL | - | 1/4 | 0.281 | 0.750 | 1.437 | 0.812 | 2.444 | 0.486 | 0.320 | Red | I-21 | 0.272 | 0.179 |
| CLND-8-14-1 | #8 AWG | #8 FLEX, #8 SOL | - | 1/4 | 0.281 | 1.000 | 1.687 | 0.812 | 2.694 | 0.486 | 0.320 | Red | I-21 | 0.272 | 0.179 |
| CLND-8-38-1 | #8 AWG | #8 FLEX, #8 SOL | - | 3/8 | 0.406 | 1.000 | 1.937 | 0.812 | 2.944 | 0.593 | 0.414 | Red | I-21 | 0.272 | 0.179 |
| CLND-6-10-12 | #6 AWG | #6 FLEX, #6 SOL | - | 10 | 0.219 | 0.500 | 1.250 | 1.125 | 2.570 | 0.440 | 0.258 | Blue | I-24 | 0.320 | 0.225 |
| CLND-6-10-58 | #6 AWG | #6 FLEX, #6 SOL | - | 10 | 0.219 | 0.625 | 1.250 | 1.125 | 2.570 | 0.440 | 0.258 | Blue | I-24 | 0.320 | 0.225 |
| CLND-6-10-1116 | #6 AWG | #6 FLEX, #6 SOL | - | 10 | 0.219 | 0.687 | 1.250 | 1.125 | 2.570 | 0.440 | 0.258 | Blue | I-24 | 0.320 | 0.225 |
| CLND-6-10-34 | #6 AWG | #6 FLEX, #6 SOL | - | 10 | 0.219 | 0.750 | 1.437 | 1.125 | 2.757 | 0.440 | 0.258 | Blue | I-24 | 0.320 | 0.225 |
| CLND-6-14-12 | #6 AWG | #6 FLEX, #6 SOL | - | 1/4 | 0.281 | 0.500 | 1.250 | 1.125 | 2.570 | 0.440 | 0.320 | Blue | I-24 | 0.320 | 0.225 |
| CLND-6-14-58 | #6 AWG | #6 FLEX, #6 SOL | - | 1/4 | 0.281 | 0.625 | 1.437 | 1.125 | 2.757 | 0.440 | 0.320 | Blue | I-24 | 0.320 | 0.225 |
| CLND-6-14-34 | #6 AWG | #6 FLEX, #6 SOL | - | 1/4 | 0.281 | 0.750 | 1.437 | 1.125 | 2.757 | 0.440 | 0.320 | Blue | I-24 | 0.320 | 0.225 |
| CLND-6-14-1 | #6 AWG | #6 FLEX, #6 SOL | - | 1/4 | 0.281 | 1.000 | 1.687 | 1.125 | 3.007 | 0.440 | 0.320 | Blue | I-24 | 0.320 | 0.225 |
| CLND-6-516-34 | #6 AWG | #6 FLEX, #6 SOL | - | 5/16 | 0.343 | 0.750 | 1.687 | 1.125 | 3.007 | 0.530 | 0.352 | Blue | I-24 | 0.320 | 0.225 |
| CLND-6-516-1 | #6 AWG | #6 FLEX, #6 SOL | - | 5/16 | 0.343 | 1.000 | 1.937 | 1.125 | 3.257 | 0.530 | 0.352 | Blue | I-24 | 0.320 | 0.225 |
| CLND-6-38-34 | #6 AWG | #6 FLEX, #6 SOL | - | 3/8 | 0.406 | 0.750 | 1.687 | 1.125 | 3.007 | 0.598 | 0.414 | Blue | I-24 | 0.320 | 0.225 |
| CLND-6-38-78 | #6 AWG | #6 FLEX, #6 SOL | - | 3/8 | 0.406 | 0.875 | 1.937 | 1.125 | 3.257 | 0.598 | 0.414 | Blue | I-24 | 0.320 | 0.225 |
| CLND-6-38-1 | #6 AWG | #6 FLEX, #6 SOL | - | 3/8 | 0.406 | 1.000 | 1.937 | 1.125 | 3.257 | 0.598 | 0.414 | Blue | I-24 | 0.320 | 0.225 |
| CLND-6-12-134 | #6 AWG | #6 FLEX, #6 SOL | - | 1/2 | 0.562 | 1.750 | 3.000 | 1.125 | 4.320 | 0.755 | 0.546 | Blue | I-24 | 0.320 | 0.225 |
| CLND-4-10-58 | #4 AWG | #4 SOL | 4-6 AWG | 10 | 0.219 | 0.625 | 1.250 | 1.125 | 2.609 | 0.486 | 0.258 | Gray | I-29 | 0.343 | 0.250 |
| CLND-4-10-34 | #4 AWG | #4 SOL | 4-6 AWG | 10 | 0.219 | 0.750 | 1.437 | 1.125 | 2.796 | 0.486 | 0.258 | Gray | I-29 | 0.343 | 0.250 |
| CLND-4-10-1 | #4 AWG | #4 SOL | 4-6 AWG | 10 | 0.219 | 1.000 | 1.687 | 1.125 | 3.046 | 0.486 | 0.258 | Gray | I-29 | 0.343 | 0.250 |
| CLND-4-14-58 | #4 AWG | #4 SOL | 4-6 AWG | 1/4 | 0.281 | 0.625 | 1.437 | 1.125 | 2.796 | 0.486 | 0.320 | Gray | I-29 | 0.343 | 0.250 |
| CLND-4-14-34 | #4 AWG | #4 SOL | 4-6 AWG | 1/4 | 0.281 | 0.750 | 1.437 | 1.125 | 2.796 | 0.486 | 0.320 | Gray | I-29 | 0.343 | 0.250 |
| CLND-4-516-34 | #4 AWG | #4 SOL | 4-6 AWG | 5/16 | 0.343 | 0.750 | 1.687 | 1.125 | 3.046 | 0.486 | 0.352 | Gray | I-29 | 0.343 | 0.250 |
| CLND-4-516-1 | #4 AWG | #4 SOL | 4-6 AWG | 5/16 | 0.343 | 1.000 | 1.937 | 1.125 | 3.296 | 0.486 | 0.352 | Gray | I-29 | 0.343 | 0.250 |
| CLND-4-38-34 | #4 AWG | #4 SOL | 4-6 AWG | 3/8 | 0.406 | 0.750 | 1.687 | 1.125 | 3.046 | 0.593 | 0.414 | Gray | I-29 | 0.343 | 0.250 |
| CLND-4-38-1 | #4 AWG | #4 SOL | 4-6 AWG | 3/8 | 0.406 | 1.000 | 1.937 | 1.125 | 3.296 | 0.593 | 0.414 | Gray | I-29 | 0.343 | 0.250 |
| CLND-4-12-134 | #4 AWG | #4 SOL | 4-6 AWG | 1/2 | 0.562 | 1.750 | 3.000 | 1.125 | 4.359 | 0.750 | 0.546 | Gray | I-29 | 0.343 | 0.250 |

Tested to UL 486A/B, UL File E6207 All wire sizes, unless noted otherwise, are American Wire Gauge (AWG) * When installed with specified dieless tools See pages 80 to 90 for complete tooling information. For Bent Tangs change the 4th letter to a B and add "-4" for 45 deg. or "-9" for 90 deg.

SureCrimp Copper Compression Lugs

Long Barrel - 2 Hole, w/o Sight Hole

Conductor Range: #1 - #3



TYPE CLND

Features

- Manufactured from high strength seamless copper tubing
- Electro-Tin plated
- Chamfered entry
- Color coded
- Suitable for use in circuits rated 35KV or less, proper high voltage spacing and insulation techniques must be used
- UL Listed and CSA Certified with nVent ILSCO and major competitor's compression tools
- UL467 Listed 500 kcmil - 10 AWG , #10 - #2 SOL
- For direct bury 500 kcmil - 10 grounding and bonding
- Rated to 90° C/194° F

Benefits

- Offers maximum conductivity and excellent crimping characteristics
- Provides low contact resistance
- For easy conductor insertion
- Identifies the proper compression die
- Application versatility

A

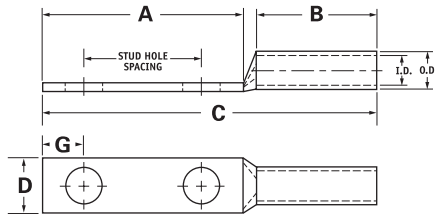

| Catalog Number | Wire Size | Alt Wire Size | Expanded* Wire Range | Bolt Size | Stud Hold Dia. | Stud Hole Spacing | Dimensions (in.) | | | | | Die Color Code | Die Index | O.D. | I.D. |
|----------------|-----------|---------------|----------------------|-----------|----------------|-------------------|------------------|-------|-------|-------|-------|----------------|-----------|-------|-------|
| | | | | | | | A | B | C | D | G | | | | |
| CLND-3-14-58 | #3 AWG | #4 FLEX | 3-6 AWG | 1/4 | 0.281 | 0.625 | 1.437 | 1.125 | 2.817 | 0.532 | 0.320 | White | I-29 | 0.375 | 0.275 |
| CLND-3-14-34 | #3 AWG | #4 FLEX | 3-6 AWG | 1/4 | 0.281 | 0.750 | 1.437 | 1.125 | 2.817 | 0.532 | 0.320 | White | I-29 | 0.375 | 0.275 |
| CLND-3-516-58 | #3 AWG | #4 FLEX | 3-6 AWG | 5/16 | 0.343 | 0.625 | 1.437 | 1.125 | 2.817 | 0.532 | 0.352 | White | I-29 | 0.375 | 0.275 |
| CLND-3-516-1 | #3 AWG | #4 FLEX | 3-6 AWG | 5/16 | 0.343 | 1.000 | 1.937 | 1.125 | 3.317 | 0.532 | 0.352 | White | I-29 | 0.375 | 0.275 |
| CLND-3-38-34 | #3 AWG | #4 FLEX | 3-6 AWG | 3/8 | 0.406 | 0.750 | 1.687 | 1.125 | 3.067 | 0.593 | 0.414 | White | I-29 | 0.375 | 0.275 |
| CLND-3-38-1 | #3 AWG | #4 FLEX | 3-6 AWG | 3/8 | 0.406 | 1.000 | 1.937 | 1.125 | 3.317 | 0.593 | 0.414 | White | I-29 | 0.375 | 0.275 |
| CLND-3-12-134 | #3 AWG | #4 FLEX | 3-6 AWG | 1/2 | 0.562 | 1.750 | 3.000 | 1.125 | 4.380 | 0.750 | 0.546 | White | I-29 | 0.375 | 0.275 |
| CLND-2-10-34 | #2 AWG | #2 SOL | 2-6 AWG | 10 | 0.219 | 0.750 | 1.437 | 1.125 | 2.848 | 0.599 | 0.258 | Brown | I-33 | 0.421 | 0.312 |
| CLND-2-14-58 | #2 AWG | #2 SOL | 2-6 AWG | 1/4 | 0.281 | 0.625 | 1.437 | 1.125 | 2.848 | 0.599 | 0.320 | Brown | I-33 | 0.421 | 0.312 |
| CLND-2-14-34 | #2 AWG | #2 SOL | 2-6 AWG | 1/4 | 0.281 | 0.750 | 1.437 | 1.125 | 2.848 | 0.599 | 0.320 | Brown | I-33 | 0.421 | 0.312 |
| CLND-2-14-1 | #2 AWG | #2 SOL | 2-6 AWG | 1/4 | 0.281 | 1.000 | 1.687 | 1.125 | 3.098 | 0.599 | 0.320 | Brown | I-33 | 0.421 | 0.312 |
| CLND-2-516-34 | #2 AWG | #2 SOL | 2-6 AWG | 5/16 | 0.343 | 0.750 | 1.687 | 1.125 | 3.098 | 0.599 | 0.352 | Brown | I-33 | 0.421 | 0.312 |
| CLND-2-516-1 | #2 AWG | #2 SOL | 2-6 AWG | 5/16 | 0.343 | 1.000 | 1.937 | 1.125 | 3.348 | 0.599 | 0.352 | Brown | I-33 | 0.421 | 0.312 |
| CLND-2-38-34 | #2 AWG | #2 SOL | 2-6 AWG | 3/8 | 0.406 | 0.750 | 1.687 | 1.125 | 3.098 | 0.599 | 0.414 | Brown | I-33 | 0.421 | 0.312 |
| CLND-2-38-78 | #2 AWG | #2 SOL | 2-6 AWG | 3/8 | 0.406 | 0.875 | 1.937 | 1.125 | 3.348 | 0.599 | 0.414 | Brown | I-33 | 0.421 | 0.312 |
| CLND-2-38-1 | #2 AWG | #2 SOL | 2-6 AWG | 3/8 | 0.406 | 1.000 | 1.937 | 1.125 | 3.348 | 0.599 | 0.414 | Brown | I-33 | 0.421 | 0.312 |
| CLND-2-38-134 | #2 AWG | #2 SOL | 2-6 AWG | 3/8 | 0.406 | 1.750 | 2.625 | 1.125 | 4.036 | 0.599 | 0.414 | Brown | I-33 | 0.421 | 0.312 |
| CLND-2-12-134 | #2 AWG | #2 SOL | 2-6 AWG | 1/2 | 0.562 | 1.750 | 3.000 | 1.125 | 4.411 | 0.750 | 0.546 | Brown | I-33 | 0.421 | 0.312 |
| CLND-1-14-58 | #1 AWG | #2 FLEX | 1-6 AWG | 1/4 | 0.281 | 0.625 | 1.437 | 1.375 | 3.142 | 0.673 | 0.320 | Green | I-37 | 0.468 | 0.359 |
| CLND-1-14-34 | #1 AWG | #2 FLEX | 1-6 AWG | 1/4 | 0.281 | 0.750 | 1.437 | 1.375 | 3.142 | 0.673 | 0.320 | Green | I-37 | 0.468 | 0.359 |
| CLND-1-14-1 | #1 AWG | #2 FLEX | 1-6 AWG | 1/4 | 0.281 | 1.000 | 1.687 | 1.375 | 3.392 | 0.673 | 0.320 | Green | I-37 | 0.468 | 0.359 |
| CLND-1-516-78 | #1 AWG | #2 FLEX | 1-6 AWG | 5/16 | 0.343 | 0.875 | 1.687 | 1.375 | 3.392 | 0.673 | 0.352 | Green | I-37 | 0.468 | 0.359 |
| CLND-1-516-1 | #1 AWG | #2 FLEX | 1-6 AWG | 5/16 | 0.343 | 1.000 | 1.937 | 1.375 | 3.642 | 0.673 | 0.352 | Green | I-37 | 0.468 | 0.359 |
| CLND-1-38-1 | #1 AWG | #2 FLEX | 1-6 AWG | 3/8 | 0.406 | 1.000 | 1.937 | 1.375 | 3.642 | 0.673 | 0.414 | Green | I-37 | 0.468 | 0.359 |
| CLND-1-12-134 | #1 AWG | #2 FLEX | 1-6 AWG | 1/2 | 0.562 | 1.750 | 3.000 | 1.375 | 4.705 | 0.750 | 0.546 | Green | I-37 | 0.468 | 0.359 |

Tested to UL 486A/B, UL File E6207

All wire sizes, unless noted otherwise, are American Wire Gauge (AWG)

* When installed with specified dieless tools See pages 80 to 90 for complete tooling information.

For Bent Tangs change the 4th letter to a B and add "-4" for 45 deg. or "-9" for 90 deg.

SureCrimp Copper Compression Lugs

Long Barrel - 2 Hole, w/o Sight Hole

Conductor Range: 3/0 - 1/0



A TYPE CLND

Features

- Manufactured from high strength seamless copper tubing
- Electro-Tin plated
- Chamfered entry
- Color coded
- Suitable for use in circuits rated 35KV or less, proper high voltage spacing and insulation techniques must be used
- UL Listed and CSA Certified with nVent ILSCO and major competitor's compression tools
- UL467 Listed 500 kcmil - 10 AWG , #10 - #2 SOL
- For direct bury 500 kcmil - 10 grounding and bonding
- Rated to 90° C/194° F

Benefits

- Offers maximum conductivity and excellent crimping characteristics
- Provides low contact resistance
- For easy conductor insertion
- Identifies the proper compression die
- Application versatility

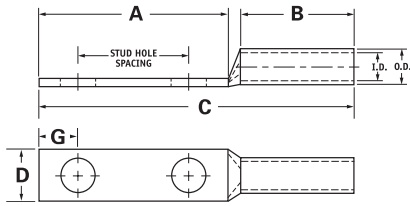

| Catalog Number | Wire Size | Alt Wire Size | Expanded* Wire Range | Bolt Size | Stud Hold Dia. | Stud Hole Spacing | Dimensions (in.) | | | | | Die Color Code | Die Index | O.D. | I.D. |
|-----------------|-----------|---------------|----------------------|-----------|----------------|-------------------|------------------|-------|-------|-------|-------|----------------|-----------|-------|-------|
| | | | | | | | A | B | C | D | G | | | | |
| CLND-1/0-14-58 | 1/0 AWG | #1 FLEX | 1/0-6 AWG | 1/4 | 0.281 | 0.625 | 1.437 | 1.500 | 3.293 | 0.738 | 0.320 | Pink | I-42 | 0.515 | 0.390 |
| CLND-1/0-14-34 | 1/0 AWG | #1 FLEX | 1/0-6 AWG | 1/4 | 0.281 | 0.750 | 1.437 | 1.500 | 3.293 | 0.738 | 0.320 | Pink | I-42 | 0.515 | 0.390 |
| CLND-1/0-14-1 | 1/0 AWG | #1 FLEX | 1/0-6 AWG | 1/4 | 0.281 | 1.000 | 1.687 | 1.500 | 3.543 | 0.738 | 0.320 | Pink | I-42 | 0.515 | 0.390 |
| CLND-1/0-516-34 | 1/0 AWG | #1 FLEX | 1/0-6 AWG | 5/16 | 0.343 | 0.750 | 1.687 | 1.500 | 3.543 | 0.738 | 0.352 | Pink | I-42 | 0.515 | 0.390 |
| CLND-1/0-516-78 | 1/0 AWG | #1 FLEX | 1/0-6 AWG | 5/16 | 0.343 | 0.875 | 1.687 | 1.500 | 3.543 | 0.738 | 0.352 | Pink | I-42 | 0.515 | 0.390 |
| CLND-1/0-516-1 | 1/0 AWG | #1 FLEX | 1/0-6 AWG | 5/16 | 0.343 | 1.000 | 1.937 | 1.500 | 3.793 | 0.738 | 0.352 | Pink | I-42 | 0.515 | 0.390 |
| CLND-1/0-38-1 | 1/0 AWG | #1 FLEX | 1/0-6 AWG | 3/8 | 0.406 | 1.000 | 1.937 | 1.500 | 3.793 | 0.738 | 0.414 | Pink | I-42 | 0.515 | 0.390 |
| CLND-1/0-38-134 | 1/0 AWG | #1 FLEX | 1/0-6 AWG | 3/8 | 0.406 | 1.750 | 2.625 | 1.500 | 4.481 | 0.738 | 0.414 | Pink | I-42 | 0.515 | 0.390 |
| CLND-1/0-12-1 | 1/0 AWG | #1 FLEX | 1/0-6 AWG | 1/2 | 0.562 | 1.000 | 2.125 | 1.500 | 3.981 | 0.738 | 0.546 | Pink | I-42 | 0.515 | 0.390 |
| CLND-1/0-12-134 | 1/0 AWG | #1 FLEX | 1/0-6 AWG | 1/2 | 0.562 | 1.750 | 3.000 | 1.500 | 4.856 | 0.738 | 0.546 | Pink | I-42 | 0.515 | 0.390 |
| CLND-2/0-14-58 | 2/0 AWG | 1/0 FLEX | 2/0-4 AWG | 1/4 | 0.281 | 0.625 | 1.437 | 1.500 | 3.333 | 0.811 | 0.320 | Black | I-45 | 0.562 | 0.437 |
| CLND-2/0-14-34 | 2/0 AWG | 1/0 FLEX | 2/0-4 AWG | 1/4 | 0.281 | 0.750 | 1.437 | 1.500 | 3.333 | 0.811 | 0.320 | Black | I-45 | 0.562 | 0.437 |
| CLND-2/0-14-1 | 2/0 AWG | 1/0 FLEX | 2/0-4 AWG | 1/4 | 0.281 | 1.000 | 1.687 | 1.500 | 3.583 | 0.811 | 0.320 | Black | I-45 | 0.562 | 0.437 |
| CLND-2/0-516-1 | 2/0 AWG | 1/0 FLEX | 2/0-4 AWG | 5/16 | 0.343 | 1.000 | 1.937 | 1.500 | 3.833 | 0.811 | 0.352 | Black | I-45 | 0.562 | 0.437 |
| CLND-2/0-38-1 | 2/0 AWG | 1/0 FLEX | 2/0-4 AWG | 3/8 | 0.406 | 1.000 | 1.937 | 1.500 | 3.833 | 0.811 | 0.414 | Black | I-45 | 0.562 | 0.437 |
| CLND-2/0-38-134 | 2/0 AWG | 1/0 FLEX | 2/0-4 AWG | 3/8 | 0.406 | 1.750 | 2.625 | 1.500 | 4.521 | 0.811 | 0.414 | Black | I-45 | 0.562 | 0.437 |
| CLND-2/0-12-1 | 2/0 AWG | 1/0 FLEX | 2/0-4 AWG | 1/2 | 0.562 | 1.000 | 2.125 | 1.500 | 4.021 | 0.811 | 0.546 | Black | I-45 | 0.562 | 0.437 |
| CLND-2/0-12-134 | 2/0 AWG | 1/0 FLEX | 2/0-4 AWG | 1/2 | 0.562 | 1.750 | 3.000 | 1.500 | 4.896 | 0.811 | 0.546 | Black | I-45 | 0.562 | 0.437 |
| CLND-3/0-14-58 | 3/0 AWG | 2/0 FLEX | 3/0-2 AWG | 1/4 | 0.281 | 0.625 | 1.437 | 1.500 | 3.376 | 0.885 | 0.320 | Orange | I-50 | 0.609 | 0.484 |
| CLND-3/0-14-34 | 3/0 AWG | 2/0 FLEX | 3/0-2 AWG | 1/4 | 0.281 | 0.750 | 1.437 | 1.500 | 3.376 | 0.885 | 0.320 | Orange | I-50 | 0.609 | 0.484 |
| CLND-3/0-516-1 | 3/0 AWG | 2/0 FLEX | 3/0-2 AWG | 5/16 | 0.343 | 1.000 | 1.937 | 1.500 | 3.876 | 0.885 | 0.352 | Orange | I-50 | 0.609 | 0.484 |
| CLND-3/0-38-1 | 3/0 AWG | 2/0 FLEX | 3/0-2 AWG | 3/8 | 0.406 | 1.000 | 1.937 | 1.500 | 3.876 | 0.885 | 0.414 | Orange | I-50 | 0.609 | 0.484 |
| CLND-3/0-12-134 | 3/0 AWG | 2/0 FLEX | 3/0-2 AWG | 1/2 | 0.562 | 1.750 | 3.000 | 1.500 | 4.939 | 0.885 | 0.546 | Orange | I-50 | 0.609 | 0.484 |

Tested to UL 486A/B, UL File E6207

All wire sizes, unless noted otherwise, are American Wire Gauge (AWG)

* When installed with specified dieless tools See pages 80 to 90 for complete tooling information.

For Bent Tangs change the 4th letter to a B and add "4" for 45 deg. or "9" for 90 deg.

SureCrimp Copper Compression Lugs

Long Barrel - 2 Hole, w/o Sight Hole

Conductor Range: 350kcmil - 4/0



TYPE CLND

Features

- Manufactured from high strength seamless copper tubing
- Electro-Tin plated
- Chamfered entry
- Color coded
- Suitable for use in circuits rated 35KV or less, proper high voltage spacing and insulation techniques must be used
- UL Listed and CSA Certified with nVent ILSCO and major competitor's compression tools
- UL467 Listed 500 kcmil - 10 AWG , #10 - #2 SOL
- For direct bury 500 kcmil - 10 grounding and bonding
- Rated to 90° C/194° F

Benefits

- Offers maximum conductivity and excellent crimping characteristics
- Provides low contact resistance
- For easy conductor insertion
- Identifies the proper compression die
- Application versatility

A

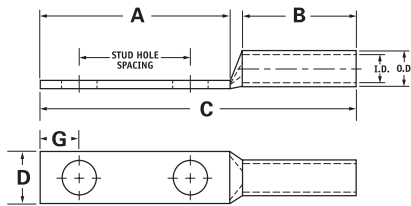

| Catalog Number | Wire Size | Alt Wire Size | Expanded* Wire Range | Bolt Size | Stud Hold Dia. | Stud Hole Spacing | Dimensions (in.) | | | | | Die Color Code | Die Index | O.D. | I.D. |
|------------------|-----------|--------------------------|----------------------|-----------|----------------|-------------------|------------------|-------|-------|-------|-------|----------------|-----------|-------|-------|
| | | | | | | | A | B | C | D | G | | | | |
| CLND-4/0-14-58 | 4/0 AWG | 3/0 FLEX | 4/0-1 AWG | 1/4 | 0.281 | 0.625 | 1.437 | 1.500 | 3.428 | 0.999 | 0.320 | Purple | I-54 | 0.687 | 0.546 |
| CLND-4/0-14-34 | 4/0 AWG | 3/0 FLEX | 4/0-1 AWG | 1/4 | 0.281 | 0.750 | 1.437 | 1.500 | 3.428 | 0.999 | 0.320 | Purple | I-54 | 0.687 | 0.546 |
| CLND-4/0-14-1 | 4/0 AWG | 3/0 FLEX | 4/0-1 AWG | 1/4 | 0.281 | 1.000 | 1.687 | 1.500 | 3.678 | 0.999 | 0.320 | Purple | I-54 | 0.687 | 0.546 |
| CLND-4/0-516-34 | 4/0 AWG | 3/0 FLEX | 4/0-1 AWG | 5/16 | 0.343 | 0.750 | 1.687 | 1.500 | 3.678 | 0.999 | 0.352 | Purple | I-54 | 0.687 | 0.546 |
| CLND-4/0-516-1 | 4/0 AWG | 3/0 FLEX | 4/0-1 AWG | 5/16 | 0.343 | 1.000 | 1.937 | 1.500 | 3.928 | 0.999 | 0.352 | Purple | I-54 | 0.687 | 0.546 |
| CLND-4/0-516-134 | 4/0 AWG | 3/0 FLEX | 4/0-1 AWG | 5/16 | 0.343 | 1.750 | 2.500 | 1.500 | 4.491 | 0.999 | 0.352 | Purple | I-54 | 0.687 | 0.546 |
| CLND-4/0-38-1 | 4/0 AWG | 3/0 FLEX | 4/0-1 AWG | 3/8 | 0.406 | 1.000 | 1.937 | 1.500 | 3.928 | 0.999 | 0.414 | Purple | I-54 | 0.687 | 0.546 |
| CLND-4/0-38-134 | 4/0 AWG | 3/0 FLEX | 4/0-1 AWG | 3/8 | 0.406 | 1.750 | 2.625 | 1.500 | 4.616 | 0.999 | 0.414 | Purple | I-54 | 0.687 | 0.546 |
| CLND-4/0-12-1 | 4/0 AWG | 3/0 FLEX | 4/0-1 AWG | 1/2 | 0.562 | 1.000 | 2.125 | 1.500 | 4.116 | 0.999 | 0.546 | Purple | I-54 | 0.687 | 0.546 |
| CLND-4/0-12-114 | 4/0 AWG | 3/0 FLEX | 4/0-1 AWG | 1/2 | 0.562 | 1.250 | 2.500 | 1.500 | 4.491 | 0.999 | 0.546 | Purple | I-54 | 0.687 | 0.546 |
| CLND-4/0-12-134 | 4/0 AWG | 3/0 FLEX | 4/0-1 AWG | 1/2 | 0.562 | 1.750 | 3.000 | 1.500 | 4.991 | 0.999 | 0.546 | Purple | I-54 | 0.687 | 0.546 |
| CLND-250-14-34 | 250kcmil | 4/0 FLEX | 250kcmil - 1/0 AWG | 1/4 | 0.281 | 0.750 | 1.437 | 1.688 | 3.656 | 1.088 | 0.320 | Yellow | I-62 | 0.750 | 0.593 |
| CLND-250-38-1 | 250kcmil | 4/0 FLEX | 250kcmil - 1/0 AWG | 3/8 | 0.406 | 1.000 | 1.937 | 1.688 | 4.156 | 1.088 | 0.414 | Yellow | I-62 | 0.750 | 0.593 |
| CLND-250-38-134 | 250kcmil | 4/0 FLEX | 250kcmil - 1/0 AWG | 3/8 | 0.406 | 1.750 | 2.625 | 1.688 | 4.844 | 1.088 | 0.414 | Yellow | I-62 | 0.750 | 0.593 |
| CLND-250-12-114 | 250kcmil | 4/0 FLEX | 250kcmil - 1/0 AWG | 1/2 | 0.562 | 1.250 | 2.500 | 1.688 | 4.719 | 1.088 | 0.546 | Yellow | I-62 | 0.750 | 0.593 |
| CLND-250-12-134 | 250kcmil | 4/0 FLEX | 250kcmil - 1/0 AWG | 1/2 | 0.562 | 1.750 | 3.000 | 1.688 | 5.219 | 1.088 | 0.546 | Yellow | I-62 | 0.750 | 0.593 |
| CLND-300-38-1 | 300kcmil | 250 G,H FLEX | 300kcmil - 2/0 AWG | 3/8 | 0.406 | 1.000 | 1.937 | 2.000 | 4.524 | 1.189 | 0.414 | White | I-66 | 0.812 | 0.660 |
| CLND-300-12-134 | 300kcmil | 250 G,H FLEX | 300kcmil - 2/0 AWG | 1/2 | 0.562 | 1.750 | 3.000 | 2.000 | 5.587 | 1.189 | 0.546 | White | I-66 | 0.812 | 0.660 |
| CLND-350-14-34 | 350kcmil | 250 I,K,M FLEX 262.2 DLO | 350kcmil - 3/0 AWG | 1/4 | 0.281 | 0.750 | 1.437 | 2.000 | 4.060 | 1.291 | 0.320 | Red | I-71 | 0.890 | 0.703 |
| CLND-350-516-134 | 350kcmil | 250 I,K,M FLEX 262.2 DLO | 350kcmil - 3/0 AWG | 5/16 | 0.343 | 1.750 | 2.500 | 2.000 | 5.123 | 1.291 | 0.352 | Red | I-71 | 0.890 | 0.703 |
| CLND-350-38-1 | 350kcmil | 250 I,K,M FLEX 262.2 DLO | 350kcmil - 3/0 AWG | 3/8 | 0.406 | 1.000 | 1.937 | 2.000 | 4.560 | 1.291 | 0.414 | Red | I-71 | 0.890 | 0.703 |
| CLND-350-12-114 | 350kcmil | 250 I,K,M FLEX 262.2 DLO | 350kcmil - 3/0 AWG | 1/2 | 0.562 | 1.250 | 2.500 | 2.000 | 5.123 | 1.291 | 0.546 | Red | I-71 | 0.890 | 0.703 |
| CLND-350-12-134 | 350kcmil | 250 I,K,M FLEX 262.2 DLO | 350kcmil - 3/0 AWG | 1/2 | 0.562 | 1.750 | 3.000 | 2.000 | 5.623 | 1.291 | 0.546 | Red | I-71 | 0.890 | 0.703 |

Tested to UL 486A/B, UL File E6207 All wire sizes, unless noted otherwise, are American Wire Gauge (AWG) * When installed with specified dies tools See pages 80 to 90 for complete tooling information. For Bent Tangs change the 4th letter to a B and add "4" for 45 deg. or "9" for 90 deg.

SureCrimp Copper Compression Lugs

Long Barrel - 2 Hole, w/o Sight Hole

Conductor Range: 650kcmil - 400kcmil



A

TYPE CLND

Features

- Manufactured from high strength seamless copper tubing
- Electro-Tin plated
- Chamfered entry
- Color coded
- Suitable for use in circuits rated 35KV or less, proper high voltage spacing and insulation techniques must be used
- UL Listed and CSA Certified with nVent ILSCO and major competitor's compression tools
- UL467 Listed 500 kcmil - 10 AWG , #10 - #2 SOL
- For direct bury 500 kcmil - 10 grounding and bonding
- Rated to 90° C/194° F

Benefits

- Offers maximum conductivity and excellent crimping characteristics
- Provides low contact resistance
- For easy conductor insertion
- Identifies the proper compression die
- Application versatility

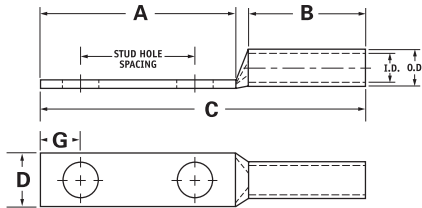

| Catalog Number | Wire Size | Alt Wire Size | Expanded* Wire Range | Bolt Size | Stud Hold Dia. | Stud Hole Spacing | Dimensions (in.) | | | | | Die Color Code | Die Index | O.D. | I.D. |
|-----------------|-----------|------------------------------|----------------------|-----------|----------------|-------------------|------------------|-------|-------|-------|--------|----------------|-----------|-------|-------|
| | | | | | | | A | B | C | D | G | | | | |
| CLND-400-38-1 | 400kcmil | 300 G,H,I,K,M FLEX 313.1 DLO | 400kcmil - 4/0 AWG | 3/8 | 0.406 | 1.000 | 1.937 | 2.125 | 4.729 | 1.365 | 0.414 | Blue | I-76 | 0.937 | 0.750 |
| CLND-400-38-116 | 400kcmil | 300 G,H,I,K,M FLEX 313.1 DLO | 400kcmil - 4/0 AWG | 3/8 | 0.406 | 1.062 | 1.937 | 2.125 | 4.729 | 1.365 | 0.414 | Blue | I-76 | 0.937 | 0.750 |
| CLND-400-12-134 | 400kcmil | 300 G,H,I,K,M FLEX 313.1 DLO | 400kcmil - 4/0 AWG | 1/2 | 0.562 | 1.750 | 3.000 | 2.125 | 5.792 | 1.365 | 0.546 | Blue | I-76 | 0.937 | 0.750 |
| CLND-500-14-34 | 500kcmil | 350 G,H,I,K,M FLEX 373.7 DLO | 500kcmil - 250kcmil | 1/4 | 0.281 | 0.750 | 1.437 | 2.250 | 4.419 | 1.535 | 0.320 | Brown | I-87 | 1.062 | 0.828 |
| CLND-500-38-1 | 500kcmil | 350 G,H,I,K,M FLEX 373.7 DLO | 500kcmil - 250kcmil | 3/8 | 0.406 | 1.000 | 1.937 | 2.250 | 4.919 | 1.535 | 0.414 | Brown | I-87 | 1.062 | 0.828 |
| CLND-500-12-114 | 500kcmil | 350 G,H,I,K,M FLEX 373.7 DLO | 500kcmil - 250kcmil | 1/2 | 0.562 | 1.250 | 2.500 | 2.250 | 5.482 | 1.535 | 0.546 | Brown | I-87 | 1.062 | 0.828 |
| CLND-500-12-134 | 500kcmil | 350 G,H,I,K,M FLEX 373.7 DLO | 500kcmil - 250kcmil | 1/2 | 0.562 | 1.750 | 3.000 | 2.250 | 5.982 | 1.535 | 0.546 | Brown | I-87 | 1.062 | 0.828 |
| CLND-600-38-1 | 600kcmil | 400 G,H,I,K,M FLEX 444.4 DLO | 600kcmil - 250kcmil | 3/8 | 0.406 | 1.000 | 1.937 | 2.687 | 5.433 | 1.712 | 0.414 | Green | I-94 | 1.187 | 0.920 |
| CLND-600-12-134 | 600kcmil | 400 G,H,I,K,M FLEX 444.4 DLO | 600kcmil - 250kcmil | 1/2 | 0.562 | 1.750 | 3.000 | 2.687 | 6.496 | 1.712 | 0.546 | Green | I-94 | 1.187 | 0.920 |
| CLND-650-12-114 | 650kcmil | 500 G,H,I,K,M FLEX 535.3 DLO | 650kcmil - 350kcmil | 1/2 | 0.562 | 1.250 | 2.500 | 2.687 | 6.056 | 1.764 | 0.546 | Pink | I-99 | 1.217 | 0.958 |
| CLND-650-12-134 | 650kcmil | 500 G,H,I,K,M FLEX 535.3 DLO | 650kcmil - 350kcmil | 1/2 | 0.562 | 1.750 | 3.000 | 2.687 | 6.556 | 1.764 | 0.546 | Pink | I-99 | 1.217 | 0.958 |
| CLND-650-38-1 | 650kcmil | 500 G,H,I,K,M FLEX 535.3 DLO | 650kcmil - 350kcmil | 3/8 | 0.406 | 1.000 | 2.125 | 2.687 | 5.493 | 1.764 | 0.414 | Pink | I-99 | 1.217 | 0.958 |
| CLND-650-38-118 | 650kcmil | 500 G,H,I,K,M FLEX 535.3 DLO | 650kcmil - 350kcmil | 3/8 | 0.406 | 1.125 | 2.125 | 2.687 | 5.681 | 1.764 | 0.414 | Pink | I-99 | 1.217 | 0.958 |
| CLND-650-516-1 | 650kcmil | 500 G,H,I,K,M FLEX 535.3 DLO | 650kcmil - 350kcmil | 1/32 | 0.343 | 1.000 | 1.937 | 2.687 | 5.493 | 1.764 | 0.3515 | Pink | I-99 | 1.217 | 0.958 |

Tested to UL 486A/B, UL File E6207

All wire sizes, unless noted otherwise, are American Wire Gauge (AWG) * When installed with specified dieless tools See pages 80 to 90 for complete tooling information.
For Bent Tangs change the 4th letter to a B and add "-4" for 45 deg. or "-9" for 90 deg.

SureCrimp Copper Compression Lugs

Long Barrel - 2 Hole, w/o Sight Hole

Conductor Range: 1000kcmil - 700kcmil



TYPE CLND

Features

- Manufactured from high strength seamless copper tubing
- Electro-Tin plated
- Chamfered entry
- Color coded
- Suitable for use in circuits rated 35KV or less, proper high voltage spacing and insulation techniques must be used
- UL Listed and CSA Certified with nVent ILSCO and major competitor's compression tools
- UL467 Listed 500 kcmil - 10 AWG , #10 - #2 SOL
- For direct bury 500 kcmil - 10 grounding and bonding
- Rated to 90° C/194° F

Benefits

- Offers maximum conductivity and excellent crimping characteristics
- Provides low contact resistance
- For easy conductor insertion
- Identifies the proper compression die
- Application versatility

A

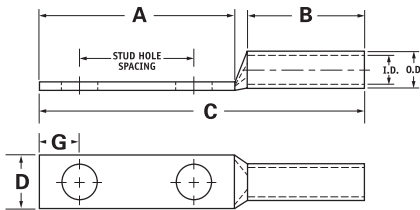

| Catalog Number | Wire Size | Alt Wire Size | Expanded* Wire Range | Bolt Size | Stud Hold Dia. | Stud Hole Spacing | Dimensions (in.) | | | | | Die Color Code | Die Index | O.D. | I.D. |
|------------------|-----------|------------------------------|----------------------|-----------|----------------|-------------------|------------------|-------|-------|-------|-------|----------------|-----------|-------|-------|
| | | | | | | | A | B | C | D | G | | | | |
| CLND-700-38-1 | 700kcmil | 500 G,H,I,K,M FLEX 535.3 DLO | 700kcmil - 350kcmil | 3/8 | 0.406 | 1.000 | 1.937 | 2.687 | 5.493 | 1.816 | 0.414 | Pink | I-99 | 1.250 | 0.991 |
| CLND-700-38-1 | 700kcmil | 500 G,H,I,K,M FLEX 535.3 DLO | 700kcmil - 350kcmil | 3/8 | 0.406 | 1.000 | 1.937 | 2.687 | 5.493 | 1.816 | 0.414 | Pink | I-99 | 1.250 | 0.991 |
| CLND-700-38-118 | 700kcmil | 500 G,H,I,K,M FLEX 535.3 DLO | 700kcmil - 350kcmil | 3/8 | 0.406 | 1.125 | 2.125 | 2.687 | 5.681 | 1.816 | 0.414 | Pink | I-99 | 1.250 | 0.991 |
| CLND-700-12-112 | 700kcmil | 500 G,H,I,K,M FLEX 535.3 DLO | 700kcmil - 350kcmil | 1/2 | 0.562 | 1.500 | 2.625 | 2.687 | 6.181 | 1.816 | 0.546 | Pink | I-99 | 1.250 | 0.991 |
| CLND-700-12-134 | 700kcmil | 500 G,H,I,K,M FLEX 350kcmil | 700kcmil - | 1/2 | 0.562 | 1.750 | 3.000 | 2.687 | 6.556 | 1.816 | 0.546 | Pink | I-99 | 1.250 | 0.991 |
| CLND-700-12-178 | 700kcmil | 500 G,H,I,K,M FLEX 535.3 DLO | 700kcmil - 350kcmil | 1/2 | 0.562 | 1.875 | 3.000 | 2.687 | 6.556 | 1.816 | 0.546 | Pink | I-99 | 1.250 | 0.991 |
| CLND-750-38-1 | 750kcmil | 600 G,H,I,M FLEX 646.4 DLO | 750kcmil - 500kcmil | 3/8 | 0.406 | 1.000 | 1.937 | 2.875 | 5.714 | 1.901 | 0.414 | Black | I-106 | 1.313 | 1.031 |
| CLND-750-38-118 | 750kcmil | 600 G,H,I,M FLEX 646.4 DLO | 750kcmil - 500kcmil | 3/8 | 0.406 | 1.125 | 2.125 | 2.875 | 5.902 | 1.901 | 0.414 | Black | I-106 | 1.313 | 1.031 |
| CLND-750-12-112 | 750kcmil | 600 G,H,I,M FLEX 646.4 DLO | 750kcmil - 500kcmil | 1/2 | 0.562 | 1.500 | 2.625 | 2.875 | 6.402 | 1.901 | 0.546 | Black | I-106 | 1.313 | 1.031 |
| CLND-750-12-134 | 750kcmil | 600 G,H,I,M FLEX 646.4 DLO | 750kcmil - 500kcmil | 1/2 | 0.562 | 1.750 | 3.000 | 2.875 | 6.777 | 1.901 | 0.546 | Black | I-106 | 1.313 | 1.031 |
| CLND-750-58-112 | 750kcmil | 600 G,H,I,M FLEX 646.4 DLO | 750kcmil - 500kcmil | 5/8 | 0.656 | 1.500 | 3.000 | 2.875 | 6.777 | 1.901 | 0.671 | Black | I-106 | 1.313 | 1.031 |
| CLND-1000-38-1 | 1000kcmil | 750 G,H,I FLEX 777.7 DLO | 1000kcmil - 750kcmil | 3/8 | 0.406 | 1.000 | 1.937 | 3.000 | 5.962 | 2.169 | 0.414 | White | I-125 | 1.500 | 1.172 |
| CLND-1000-12-114 | 1000kcmil | 750 G,H,I FLEX 777.7 DLO | 1000kcmil - 750kcmil | 1/2 | 0.562 | 1.250 | 2.500 | 3.000 | 6.525 | 2.169 | 0.546 | White | I-125 | 1.500 | 1.172 |
| CLND-1000-12-134 | 1000kcmil | 750 G,H,I FLEX 777.7 DLO | 1000kcmil - 750kcmil | 1/2 | 0.562 | 1.750 | 3.000 | 3.000 | 7.025 | 2.169 | 0.546 | White | I-125 | 1.500 | 1.172 |
| CLND-1000-58-112 | 1000kcmil | 750 G,H,I FLEX 777.7 DLO | 1000kcmil - 750kcmil | 5/8 | 0.656 | 1.500 | 3.000 | 3.000 | 7.025 | 2.169 | 0.671 | White | I-125 | 1.500 | 1.172 |

Tested to UL 486A/B, UL File E6207

All wire sizes, unless noted otherwise, are American Wire Gauge (AWG)
For Bent Tangs change the 4th letter to a B and add "-4" for 45 deg. or "-9" for 90 deg.

* When installed with specified dieless tools See pages 80 to 90 for complete tooling information.

SureCrimp Copper Compression Lugs

Long Barrel - Flared End, w/o Sight Hole

Conductor Range: 500kcmil - 2/0



A TYPE CLNF

Features

- Manufactured from high strength seamless copper tubing
- Electro-Tin plated
- Chamfered entry
- Color coded
- Suitable for use in circuits rated 35KV or less, proper high voltage spacing and insulation techniques must be used
- UL Listed and CSA Certified with nVent ILSCO and major competitor's compression tools
- Rated to 90° C/194° F

Benefits

- Offers maximum conductivity and excellent crimping characteristics
- Provides low contact resistance
- For easy conductor insertion
- Identifies the proper compression die
- Application versatility
- Reduces inventory requirements

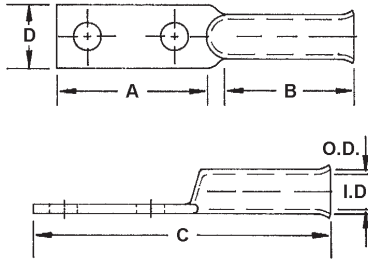

| Catalog Number | Wire Size | Alt Wire Size | Expanded* Wire Range | Bolt Size | Stud Hold Dia. | Stud Hole Spacing | Dimensions (in.) | | | | | Die Color Code | Die Index | O.D. | I.D. |
|-----------------|-----------|------------------------------|----------------------|-----------|----------------|-------------------|------------------|-------|-------|-------|-------|----------------|-----------|-------|-------|
| | | | | | | | A | B | C | D | G | | | | |
| CLNF-2/0-12-134 | 2/0 AWG | 1/0 FLEX | 2/0-4 AWG | 1/2 | 0.531 | 1.750 | 3.000 | 1.938 | 5.219 | 0.813 | 0.546 | Black | I-45 | 0.562 | 0.437 |
| CLNF-2/0-38 | 2/0 AWG | 1/0 FLEX | 2/0-4 AWG | 3/8 | 0.406 | - | 0.875 | 1.938 | 3.094 | 0.813 | 0.414 | Black | I-45 | 0.562 | 0.437 |
| CLNF-3/0-12-134 | 3/0 AWG | 2/0 FLEX | 3/0-2 AWG | 1/2 | 0.531 | 1.750 | 3.000 | 1.938 | 5.250 | 0.906 | 0.546 | Orange | I-50 | 0.609 | 0.484 |
| CLNF-3/0-12 | 3/0 AWG | 2/0 FLEX | 3/0-2 AWG | 1/2 | 0.531 | - | 1.000 | 1.938 | 3.250 | 0.906 | 0.546 | Orange | I-50 | 0.609 | 0.484 |
| CLNF-4/0-12-134 | 4/0 AWG | 3/0 FLEX | 4/0-1 AWG | 1/2 | 0.531 | 1.750 | 3.000 | 2.125 | 5.469 | 1.000 | 0.546 | Purple | I-54 | 0.687 | 0.546 |
| CLNF-4/0-12 | 4/0 AWG | 3/0 FLEX | 4/0-1 AWG | 1/2 | 0.531 | - | 1.000 | 2.125 | 3.469 | 1.000 | 0.546 | Purple | I-54 | 0.687 | 0.546 |
| CLNF-250-12-134 | 250kcmil | 4/0 FLEX | 250kcmil - 1/0 AWG | 1/2 | 0.531 | 1.750 | 3.000 | 2.125 | 5.563 | 1.090 | 0.546 | Yellow | I-62 | 0.750 | 0.593 |
| CLNF-250-12 | 250kcmil | 4/0 FLEX | 250kcmil - 1/0 AWG | 1/2 | 0.531 | - | 1.125 | 2.125 | 3.688 | 1.090 | 0.546 | Yellow | I-62 | 0.750 | 0.593 |
| CLNF-300-12-134 | 300kcmil | 250 G, H FLEX | 300kcmil - 2/0 AWG | 1/2 | 0.531 | 1.750 | 3.000 | 2.250 | 5.937 | 1.188 | 0.546 | White | I-66 | 0.812 | 0.660 |
| CLNF-300-58 | 300kcmil | 250 G, H FLEX | 300kcmil - 2/0 AWG | 5/8 | 0.656 | - | 1.125 | 2.250 | 3.875 | 1.188 | 0.671 | White | I-66 | 0.812 | 0.660 |
| CLNF-350-12-134 | 350kcmil | 250 I,K,M FLEX 262.2 DLO | 350kcmil - 3/0 AWG | 1/2 | 0.531 | 1.750 | 3.000 | 2.563 | 6.000 | 1.280 | 0.546 | Red | I-71 | 0.890 | 0.703 |
| CLNF-350-58 | 350kcmil | 250 I,K,M FLEX 262.2 DLO | 350kcmil - 3/0 AWG | 5/8 | 0.656 | - | 1.125 | 2.563 | 4.125 | 1.280 | 0.671 | Red | I-71 | 0.890 | 0.703 |
| CLNF-400-12-134 | 400kcmil | 300 G,H,I,K,M FLEX 313.1 DLO | 400kcmil - 4/0 AWG | 1/2 | 0.531 | 1.750 | 3.000 | 2.688 | 6.313 | 1.375 | 0.546 | Blue | I-76 | 0.937 | 0.750 |
| CLNF-400-58 | 400kcmil | 300 G,H,I,K,M FLEX 313.1 DLO | 400kcmil - 4/0 AWG | 5/8 | 0.656 | - | 1.500 | 2.688 | 4.813 | 1.375 | 0.671 | Blue | I-76 | 0.937 | 0.750 |
| CLNF-500-12-134 | 500kcmil | 350 G,H,I,K,M FLEX 373.7 DLO | 500kcmil - 250kcmil | 1/2 | 0.531 | 1.750 | 3.000 | 2.813 | 6.313 | 1.531 | 0.546 | Brown | I-87 | 1.062 | 0.828 |
| CLNF-500-58 | 500kcmil | 350 G,H,I,K,M FLEX 373.7 DLO | 500kcmil - 250kcmil | 5/8 | 0.656 | - | 1.500 | 2.813 | 4.813 | 1.531 | 0.671 | Brown | I-87 | 1.062 | 0.828 |

Tested to UL 486A/B, UL File E6207

All wire sizes, unless noted otherwise, are American Wire Gauge (AWG) * When installed with specified dieless tools See pages 80 to 90 for complete tooling information.

For Bent Tangs change the 4th letter to a B and add "-4" for 45 deg. or "-9" for 90 deg.

SureCrimp Copper Compression Lugs

Long Barrel - Flared End, w/o Sight Hole

Conductor Range: 1111kcmil - 600kcmil



TYPE CLNF

Features

- Manufactured from high strength seamless copper tubing
- Electro-Tin plated
- Chamfered entry
- Color coded
- Suitable for use in circuits rated 35KV or less, proper high voltage spacing and insulation techniques must be used
- UL Listed and CSA Certified with nVent ILSCO and major competitor's compression tools
- Rated to 90° C/194° F

Benefits

- Offers maximum conductivity and excellent crimping characteristics
- Provides low contact resistance
- For easy conductor insertion
- Identifies the proper compression die
- Application versatility
- Reduces inventory requirements

A

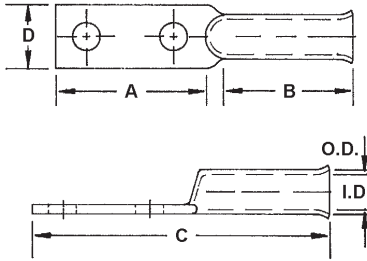

| Catalog Number | Wire Size | Alt Wire Size | Expanded* Wire Range | Bolt Size | Stud Hold Dia. | Stud Hole Spacing | Dimensions (in.) | | | | | Die Color Code | Die Index | O.D. | I.D. |
|------------------|-----------|------------------------------|----------------------|-----------|----------------|-------------------|------------------|-------|-------|-------|-------|----------------|-----------|-------|-------|
| | | | | | | | A | B | C | D | G | | | | |
| CLNF-600-12-134 | 600kcmil | 400 G,H,I,K,M FLEX 444.4 DLO | 600kcmil - 250kcmil | 1/2 | 0.531 | 1.750 | 3.000 | 2.875 | 6.813 | 1.680 | 0.546 | Green | I-94 | 1.187 | 0.920 |
| CLNF-600-58 | 600kcmil | 400 G,H,I,K,M FLEX 444.4 DLO | 600kcmil - 250kcmil | 5/8 | 0.656 | - | 1.500 | 2.875 | 5.375 | 1.680 | 0.671 | Green | I-94 | 1.187 | 0.920 |
| CLNF-700-12-134 | 700kcmil | 500 G,H,I,K,M FLEX 535.3 DLO | 700kcmil - 350kcmil | 1/2 | 0.531 | 1.750 | 3.000 | 2.813 | 6.625 | 1.844 | 0.546 | Pink | I-99 | 1.250 | 0.991 |
| CLNF-700-58 | 700kcmil | 500 G,H,I,K,M FLEX 535.3 DLO | 700kcmil - 350kcmil | 5/8 | 0.656 | - | 1.750 | 2.563 | 5.375 | 1.844 | 0.671 | Pink | I-99 | 1.250 | 0.991 |
| CLNF-750-12-134 | 750kcmil | 600 G,H,I,M FLEX 646.4 DLO | 750kcmil - 500kcmil | 1/2 | 0.531 | 1.750 | 3.000 | 2.813 | 6.625 | 1.906 | 0.546 | Black | I-106 | 1.313 | 1.031 |
| CLNF-750-58 | 750kcmil | 600 G,H,I,M FLEX 646.4 DLO | 750kcmil - 500kcmil | 5/8 | 0.656 | - | 1.938 | 2.813 | 5.563 | 1.906 | 0.671 | Black | I-106 | 1.313 | 1.031 |
| CLNF-1000-12-134 | 1000kcmil | 750 G,H, I FLEX 777.7 DLO | 1000kcmil - 750kcmil | 1/2 | 0.531 | 1.750 | 3.000 | 3.563 | 7.438 | 2.188 | 0.546 | White | I-125 | 1.500 | 1.172 |
| CLNF-1000-58 | 1000kcmil | 750 G,H, I FLEX 777.7 DLO | 1000kcmil - 750kcmil | 5/8 | 0.656 | - | 2.125 | 3.563 | 6.563 | 2.188 | 0.671 | White | I-125 | 1.500 | 1.172 |
| CLNF-1111-12-134 | 1111kcmil | - | - | 1/2 | 0.562 | 1.750 | 3.000 | 3.313 | 7.438 | 2.600 | 0.546 | White | IDT-12 | 1.750 | 1.458 |
| CLNF-1111-58 | 1111kcmil | - | - | 5/8 | 0.656 | - | 2.250 | 3.563 | 6.688 | 2.600 | 0.671 | White | IDT-12 | 1.750 | 1.458 |

Tested to UL 486A/B, UL File E6207

All wire sizes, unless noted otherwise, are American Wire Gauge (AWG) * When installed with specified dieless tools See pages 80 to 90 for complete tooling information.
For Bent Tangs change the 4th letter to a B and add "-4" for 45 deg. or "-9" for 90 deg.

SureCrimp

Copper Compression Lugs 500kcmil



A TYPE CLNU

Features

- Manufactured from high strength seamless copper tubing
- Electro-Tin plated
- Chamfered entry
- Color coded
- Suitable for use in circuits rated 35KV or less, proper high voltage spacing and insulation techniques must be used
- UL Listed and CSA Certified with nVent ILSCO and major competitor's compression tools
- UL467 Listed 500 kcmil - 8 AWG , #8 - #2 SOL
- or direct bury 500 kcmil - 10 grounding and bonding
- Rated to 90° C/194° F

Benefits

- Offers maximum conductivity and excellent crimping characteristics
- Provides low contact resistance
- For easy conductor insertion
- Identifies the proper compression die
- Application versatility
- Reduces inventory requirements
- For grounding and bonding applications

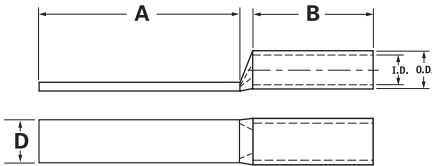

| Catalog Number | Wire Size | Alt Wire Size | Expanded* Wire Range | Dimensions (in.) | | | Die Color Code | Die Index | O.D. | I.D. |
|----------------|-----------|------------------------------|----------------------|------------------|-------|-------|----------------|-----------|-------|-------|
| | | | | A | B | D | | | | |
| CLNU-6 | 6 AWG | #6 FLEX, #6 SOL | - | 3.000 | 1.130 | 0.760 | Blue | I-24 | 0.320 | 0.225 |
| CLNU-4 | 4 AWG | #4 SOL | 4-6 AWG | 3.000 | 1.130 | 0.760 | White | I-29 | 0.343 | 0.250 |
| CLNU-3 | 3 AWG | #4 FLEX | 3-6 AWG | 3.000 | 1.130 | 0.750 | White | I-29 | 0.375 | 0.275 |
| CLNU-2 | 2 AWG | #2 SOL | 2-6 AWG | 3.000 | 1.130 | 0.740 | Brown | I-33 | 0.421 | 0.312 |
| CLNU-1 | 1 AWG | #2 FLEX | 1-6 AWG | 3.000 | 1.380 | 0.740 | Green | I-37 | 0.468 | 0.359 |
| CLNU-1/0 | 1/0 AWG | #1 FLEX | 1/0-6 AWG | 3.000 | 1.500 | 0.740 | Pink | I-42 | 0.515 | 0.390 |
| CLNU-2/0 | 2/0 AWG | 1/0 FLEX | 2/0-4 AWG | 3.000 | 1.500 | 0.810 | Black | I-45 | 0.562 | 0.437 |
| CLNU-3/0 | 3/0 AWG | 2/0 FLEX | 3/0-2 AWG | 3.000 | 1.500 | 0.890 | Orange | I-50 | 0.609 | 0.484 |
| CLNU-4/0 | 4/0 AWG | 3/0 FLEX | 4/0-1 AWG | 3.000 | 1.500 | 1.000 | Purple | I-54 | 0.687 | 0.546 |
| CLNU-250 | 250kcmil | 4/0 FLEX | 250kcmil-1/0 AWG | 3.000 | 1.690 | 1.090 | Yellow | I-62 | 0.750 | 0.593 |
| CLNU-300 | 300kcmil | 250 G,H FLEX | 300kcmil-2/0 AWG | 3.000 | 2.000 | 1.190 | White | I-66 | 0.812 | 0.660 |
| CLNU-350 | 350kcmil | 250 I,K,M FLEX 262.2 DLO | 350kcmil-3/0 AWG | 3.000 | 2.000 | 1.290 | Red | I-71 | 0.890 | 0.703 |
| CLNU-400 | 400kcmil | 300 G,H,I,K,M FLEX 313.1 DLO | 400kcmil-4/0 AWG | 3.000 | 2.130 | 1.370 | Blue | I-76 | 0.937 | 0.750 |
| CLNU-500 | 500kcmil | 350 G,H,I,K,M FLEX 373.7 DLO | 500kcmil-250kcmil | 3.000 | 2.250 | 1.530 | Brown | I-87 | 1.062 | 0.828 |
| CLNU-600 | 600kcmil | 400 G,H,I,K,M FLEX 444.4 DLO | 600kcmil-250kcmil | 3.000 | 2.690 | 1.710 | Green | I-94 | 1.187 | 0.920 |
| CLNU-650 | 650kcmil | 500 G,H,I,K,M FLEX 535.3 DLO | 650kcmil-350kcmil | 3.000 | 2.690 | 1.760 | Pink | I-99 | 1.217 | 0.958 |
| CLNU-700 | 700kcmil | 500 G,H,I,K,M FLEX 535.3 DLO | 700kcmil-350kcmil | 3.000 | 2.690 | 1.820 | Pink | I-99 | 1.250 | 0.991 |
| CLNU-750 | 750kcmil | 600 G,H,I,M FLEX 646.4 DLO | 750kcmil-500kcmil | 3.000 | 2.880 | 1.900 | Black | I-106 | 1.313 | 1.031 |
| CLNU-1000 | 1000kcmil | 750 G,H,I FLEX 777.7 DLO | 1000kcmil-750kcmil | 3.000 | 3.000 | 2.170 | White | I-125 | 1.500 | 1.172 |

Tested to UL 486A/B, UL File E6207

All wire sizes, unless noted otherwise, are American Wire Gauge (AWG) * When installed with specified dieless tools See pages 80 to 90 for complete tooling information.
For Bent Tangs change the 4th letter to a B and add "4" for 45 deg. or "9" for 90 deg.

SureCrimp Copper Compression Lugs

Std Barrel - Narrow Tang w/Sight Hole

Conductor Range: 1000kcmil - #2



TYPE CSWN

Features

- Manufactured from high strength seamless copper tubing
- Electro-Tin plated
- Narrow tang width
- Chamfered entry
- Color coded
- Suitable for use in circuits rated 35KV or less, proper high voltage spacing and insulation techniques must be used
- UL Listed and CSA Certified with nVent ILSCO and major competitor's compression tools
- UL467 Listed 500 kcmil - 8 AWG , #8 - #2 SOL
- For direct bury 500 kcmil - 10 grounding and bonding
- Rated to 90° C/194° F

Benefits

- Offers maximum conductivity and excellent crimping characteristics
- Provides low contact resistance
- For limited space applications
- For easy conductor insertion
- Identifies the proper compression die
- Application versatility
- Reduces inventory requirements
- For grounding and bonding applications

A

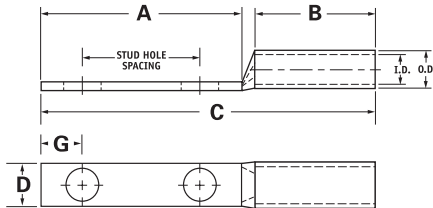

| Catalog Number | Wire Size | Alt Wire Size | Expanded* Wire Range | Bolt Size | Stud Hold Dia. | Stud Hole Spacing | Dimensions (in.) | | | | | Die Color Code | Die Index | O.D. | I.D. |
|------------------|-----------|------------------------------|----------------------|-----------|----------------|-------------------|------------------|-------|-------|-------|-------|----------------|-----------|-------|-------|
| | | | | | | | A | B | C | D | G | | | | |
| CSWN-2-14 | #2 AWG | #2 SOL | 2-6 AWG | 1/4 | 0.281 | - | 0.875 | 0.625 | 1.786 | 0.406 | 0.320 | Brown | I-33 | 0.421 | 0.312 |
| CSWN-2-14-58 | #2 AWG | #2 SOL | 2-6 AWG | 1/4 | 0.281 | 0.625 | 1.437 | 0.625 | 2.348 | 0.406 | 0.320 | Brown | I-33 | 0.421 | 0.312 |
| CSWN-1-14 | #1 AWG | #2 FLEX | 1-6 AWG | 1/4 | 0.281 | - | 0.875 | 0.625 | 1.830 | 0.453 | 0.320 | Green | I-37 | 0.468 | 0.359 |
| CSWN-1/0-516 | 1/0 AWG | #1 FLEX | 1/0-6 AWG | 5/16 | 0.343 | - | 0.875 | 0.850 | 2.081 | 0.500 | 0.352 | Pink | I-42 | 0.515 | 0.390 |
| CSWN-2/0-516 | 2/0 AWG | 1/0 FLEX | 2/0-4 AWG | 5/16 | 0.343 | - | 0.875 | 0.850 | 2.121 | 0.547 | 0.352 | Black | I-45 | 0.562 | 0.437 |
| CSWN-3/0-38 | 3/0 AWG | 2/0 FLEX | 3/0-2 AWG | 3/8 | 0.406 | - | 0.875 | 0.850 | 2.164 | 0.594 | 0.414 | Orange | I-50 | 0.609 | 0.484 |
| CSWN-4/0-38 | 4/0 AWG | 3/0 FLEX | 4/0-1 AWG | 3/8 | 0.406 | - | 0.875 | 0.975 | 2.341 | 0.672 | 0.414 | Purple | I-54 | 0.687 | 0.546 |
| CSWN-250-38-1 | 250kcmil | 4/0 FLEX | 250kcmil - 1/0 AWG | 3/8 | 0.406 | - | 1.937 | 1.163 | 3.631 | 0.735 | 0.414 | Yellow | I-62 | 0.750 | 0.593 |
| CSWN-350-38 | 350kcmil | 250 I,K,M FLEX 262.2 DLO | 350kcmil - 3/0 AWG | 3/8 | 0.406 | - | 0.875 | 1.063 | 2.561 | 0.875 | 0.414 | Red | I-71 | 1.250 | 0.703 |
| CSWN-350-38-1 | 350kcmil | 250 I,K,M FLEX 262.2 DLO | 350kcmil - 3/0 AWG | 3/8 | 0.406 | 1.000 | 1.937 | 1.063 | 3.623 | 0.875 | 0.414 | Red | I-71 | 1.250 | 0.703 |
| CSWN-500-38 | 500kcmil | 350 G,H,I,K,M FLEX 373.7 DLO | 500kcmil - 250kcmil | 3/8 | 0.406 | - | 0.875 | 1.300 | 2.907 | 1.047 | 0.414 | Brown | I-87 | 1.250 | 0.828 |
| CSWN-600-38 | 600kcmil | 400 G,H,I,K,M FLEX 444.4 DLO | 600kcmil - 250kcmil | 3/8 | 0.406 | - | 0.875 | 1.375 | 3.059 | 1.172 | 0.414 | Green | I-94 | 1.250 | 0.920 |
| CSWN-750-38-1 | 750kcmil | 600 G,H,I,M FLEX 646.4 DLO | 750kcmil - 500kcmil | 3/8 | 0.406 | 1.000 | 1.937 | 1.500 | 4.339 | 1.298 | 0.414 | Black | I-106 | 1.250 | 1.031 |
| CSWN-1000-38-1 | 1000kcmil | 750 G,H,I FLEX 777.7 DLO | 1000kcmil - 750kcmil | 3/8 | 0.406 | 1.000 | 1.937 | 1.625 | 4.587 | 1.485 | 0.414 | White | I-125 | 1.250 | 1.172 |
| CSWN-1000-12-134 | 1000kcmil | 750 G,H,I FLEX 777.7 DLO | 1000kcmil - 750kcmil | 1/2 | 0.562 | 1.750 | 3.000 | 1.625 | 5.650 | 1.485 | 0.546 | White | I-125 | 1.250 | 1.172 |

Tested to UL 486A/B, UL File E6207

All wire sizes, unless noted otherwise, are American Wire Gauge (AWG)

* When installed with specified dieless tools See pages 80 to 90 for complete tooling information.

For Bent Tangs change the 4th letter to a B and add "-4" for 45 deg. or "-9" for 90 deg.

SureCrimp Copper Compression Lugs

Long Barrel - Narrow Tang, w/Sight Hole

Conductor Range: 1000kcmil - 250kcmil



A TYPE CLWN

Features

- Manufactured from high strength seamless copper tubing
- Electro-Tin plated
- Narrow tang width
- Chamfered entry
- Color coded
- Suitable for use in circuits rated 35KV or less, proper high voltage spacing and insulation techniques must be used
- UL Listed and CSA Certified with nVent ILSCO and major competitor's compression tools
- UL467 Listed 500 kcmil - 8 AWG , #8 - #2 SOL
- For direct bury 500 kcmil - 10 grounding and bonding
- Rated to 90° C/194° F

Benefits

- Offers maximum conductivity and excellent crimping characteristics
- Provides low contact resistance
- For limited space applications
- For easy conductor insertion
- Identifies the proper compression die
- Application versatility
- Reduces inventory requirements
- For grounding and bonding applications

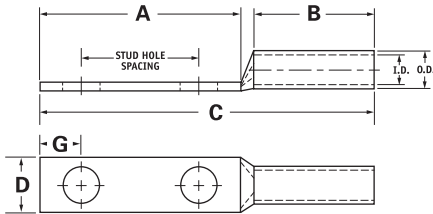

| Catalog Number | Wire Size | Alt Wire Size | Expanded* Wire Range | Bolt Size | Stud Hold Dia. | Stud Hole Spacing | Dimensions (in.) | | | | | Die Color Code | Die Index | O.D. | I.D. |
|-----------------|-----------|------------------------------|----------------------|-----------|----------------|-------------------|------------------|-------|-------|-------|-------|----------------|-----------|-------|-------|
| | | | | | | | A | B | C | D | G | | | | |
| CLWN-250-38-1 | 250kcmil | 4/0 FLEX | 250kcmil - 1/0 AWG | 3/8 | 0.406 | - | 1.937 | 1.688 | 4.156 | 0.735 | 0.414 | Yellow | I-62 | 0.750 | 0.593 |
| CLWN-500-38-1 | 500kcmil | 350 G,H,I,K,M FLEX 373.7 DLO | 500kcmil - 250kcmil | 3/8 | 0.406 | 1.000 | 1.937 | 2.250 | 4.919 | 1.047 | 0.414 | Brown | I-87 | 1.062 | 0.828 |
| CLWN-700-38-1 | 700kcmil | 500 G,H,I,K,M FLEX 535.3 DLO | 700kcmil - 350kcmil | 3/8 | 0.406 | 1.000 | 1.937 | 2.687 | 5.493 | 1.235 | 0.414 | Pink | I-99 | 1.250 | 0.991 |
| CLWN-700-12-134 | 700kcmil | 500 G,H,I,K,M FLEX 535.3 DLO | 700kcmil - 350kcmil | 1/2 | 0.562 | 1.750 | 3.000 | 2.687 | 6.556 | 1.235 | 0.546 | Pink | I-99 | 1.250 | 0.991 |
| CLWN-750-38-1 | 750kcmil | 600 G,H,I,M FLEX 646.4 DLO | 750kcmil - 500kcmil | 3/8 | 0.406 | 1.000 | 1.937 | 2.875 | 5.714 | 1.298 | 0.414 | Black | I-106 | 1.313 | 1.031 |
| CLWN-750-12-134 | 750kcmil | 600 G,H,I,M FLEX 646.4 DLO | 750kcmil - 500kcmil | 1/2 | 0.562 | 1.750 | 3.000 | 2.875 | 6.777 | 1.298 | 0.546 | Black | I-106 | 1.313 | 1.031 |
| CLWN-1000-38-1 | 1000kcmil | 750 G,H,I FLEX 777.7 DLO | 1000kcmil - 750kcmil | 3/8 | 0.406 | 1.000 | 1.937 | 3.000 | 5.962 | 1.485 | 0.414 | White | I-125 | 1.500 | 1.172 |

Tested to UL 486A/B, UL File E6207

All wire sizes, unless noted otherwise, are American Wire Gauge (AWG) * When installed with specified dieless tools See pages 80 to 90 for complete tooling information.
For Bent Tangs change the 4th letter to a B and add "-4" for 45 deg. or "-9" for 90 deg.

SureCrimp Copper Compression Lugs

Slotted Tang, w/Sight Hole

Conductor Range: 300kcmil - 6



TYPE CSLT

Features

- Manufactured from high strength seamless copper tubing
- Electro-Tin plated
- Chamfered entry
- 2-hole tang provides maximum secureness, more contact surface and prevents rotation
- Color coded
- UL467 Listed for grounding and bonding applications,
- #8-#2 solid, 500kcmil - 8 AWG
- Suitable for use in circuits rated 35KV or less, proper high voltage spacing and insulation techniques must be used
- UL Listed and CSA Certified with nVent ILSCO and major competitor's compression tools
- For direct bury 500 kcmil - 10 grounding and bonding

Benefits

- Offers maximum conductivity and excellent crimping characteristics
- Provides low contact resistance
- For easy conductor insertion
- 2nd hole slotted to accommodate variable spacing requirements
- Identifies the proper compression die
- Application versatility
- Reduces inventory requirements

A

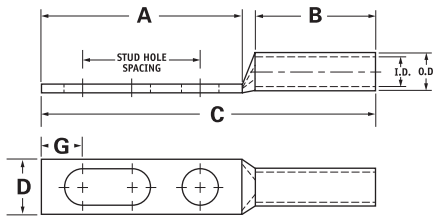

| Catalog Number | Wire Size | Alt Wire Size | Expanded* Wire Range | Bolt Size | Stud Hold Dia. | Stud Hole Spacing | Dimensions (in.) | | | | | Die Color Code | Die Index | O.D. | I.D. |
|--------------------|-----------|-----------------|----------------------|-----------|----------------|-------------------|------------------|-------|-------|-------|-------|----------------|-----------|-------|-------|
| | | | | | | | A | B | C | D | G | | | | |
| CLWDS-6-14-58-1 | #6 AWG | #6 FLEX, #6 SOL | - | 1/4 | 0.281 | 5/8 to 1 | 1.687 | 1.125 | 3.007 | 0.406 | 0.320 | BLUE | I-24 | 0.312 | 0.225 |
| CLWDS-4-14-58-1 | #4 AWG | #4 SOL | 4-6 AWG | 1/4 | 0.281 | 5/8 to 1 | 1.687 | 1.125 | 3.046 | 0.486 | 0.320 | GRAY | I-29 | 0.343 | 0.250 |
| CLWDS-4-38-58-1 | #4 AWG | #4 SOL | 4-6 AWG | 3/8 | 0.406 | 5/8 to 1 | 1.937 | 1.125 | 3.296 | 0.592 | 0.414 | GRAY | I-29 | 0.343 | 0.250 |
| CLWDS-3-14-58-1 | #3 AWG | #4 FLEX | 3-6 AWG | 1/4 | 0.281 | 5/8 to 1 | 1.687 | 1.125 | 3.067 | 0.532 | 0.320 | WHITE | I-29 | 0.375 | 0.275 |
| CLWDS-3-38-58-1 | #3 AWG | #4 FLEX | 3-6 AWG | 3/8 | 0.406 | 5/8 to 1 | 1.937 | 1.125 | 3.317 | 0.592 | 0.414 | WHITE | I-29 | 0.375 | 0.275 |
| CLWDS-2-14-58-1 | #2 AWG | #2 SOL | 2-6 AWG | 1/4 | 0.281 | 5/8 to 1 | 1.687 | 1.125 | 3.098 | 0.599 | 0.320 | BROWN | I-33 | 0.421 | 0.312 |
| CLWDS-2-38-58-1 | #2 AWG | #2 SOL | 2-6 AWG | 3/8 | 0.406 | 5/8 to 1 | 1.937 | 1.125 | 3.348 | 0.599 | 0.414 | BROWN | I-33 | 0.421 | 0.312 |
| CLWDS-1-14-58-1 | #1 AWG | #2 FLEX | 1-6 AWG | 1/4 | 0.281 | 5/8 to 1 | 1.687 | 1.375 | 3.392 | 0.673 | 0.320 | GREEN | I-37 | 0.468 | 0.359 |
| CLWDS-1-38-58-1 | #1 AWG | #2 FLEX | 1-6 AWG | 3/8 | 0.406 | 5/8 to 1 | 1.937 | 1.375 | 3.642 | 0.673 | 0.414 | GREEN | I-37 | 0.468 | 0.359 |
| CLWDS-1/0-38-1-134 | 1/0 AWG | #1 FLEX | 1/0-6 AWG | 3/8 | 0.406 | 1 to 1-3/4 | 2.625 | 1.600 | 4.581 | 0.738 | 0.414 | PINK | I-42 | 0.515 | 0.390 |
| CLWDS-1/0-12-1-134 | 1/0 AWG | #1 FLEX | 1/0-6 AWG | 1/2 | 0.562 | 1 to 1-3/4 | 3.000 | 1.600 | 4.956 | 0.738 | 0.546 | PINK | I-42 | 0.515 | 0.390 |
| CLWDS-2/0-38-1-134 | 2/0 AWG | 1/0 FLEX | 2/0-4 AWG | 3/8 | 0.406 | 1 to 1-3/4 | 6.625 | 1.600 | 4.621 | 0.811 | 0.414 | BLACK | I-45 | 0.562 | 0.437 |
| CLWDS-2/0-12-1-134 | 2/0 AWG | 1/0 FLEX | 2/0-4 AWG | 1/2 | 0.562 | 1 to 1-3/4 | 3.000 | 1.600 | 4.996 | 0.811 | 0.546 | BLACK | I-45 | 0.562 | 0.437 |
| CLWDS-3/0-38-1-134 | 3/0 AWG | 2/0 FLEX | 3/0-2 AWG | 3/8 | 0.406 | 1 to 1-3/4 | 2.625 | 1.600 | 4.664 | 0.885 | 0.414 | ORANGE | I-50 | 0.609 | 0.484 |
| CLWDS-3/0-12-1-134 | 3/0 AWG | 2/0 FLEX | 3/0-2 AWG | 1/2 | 0.562 | 1 to 1-3/4 | 3.000 | 1.600 | 5.039 | 0.885 | 0.546 | ORANGE | I-50 | 0.609 | 0.484 |
| CLWDS-4/0-38-1-134 | 4/0 AWG | 3/0 FLEX | 4/0-1 AWG | 3/8 | 0.406 | 1 to 1-3/4 | 2.625 | 1.600 | 4.716 | 0.999 | 0.414 | PURPLE | I-54 | 0.687 | 0.546 |
| CLWDS-4/0-12-1-134 | 4/0 AWG | 3/0 FLEX | 4/0-1 AWG | 1/2 | 0.562 | 1 to 1-3/4 | 3.000 | 1.600 | 5.091 | 0.999 | 0.546 | PURPLE | I-54 | 0.687 | 0.546 |
| CLWDS-250-38-1-134 | 250kcmil | 4/0 FLEX | 250kcmil - 1/0 AWG | 3/8 | 0.406 | 1 to 1-3/4 | 2.625 | 1.788 | 4.944 | 1.088 | 0.414 | YELLOW | I-62 | 0.750 | 0.593 |
| CLWDS-250-12-1-134 | 250kcmil | 4/0 FLEX | 250kcmil - 1/0 AWG | 1/2 | 0.562 | 1 to 1-3/4 | 3.000 | 1.788 | 5.319 | 1.088 | 0.546 | YELLOW | I-62 | 0.750 | 0.593 |
| CLWDS-300-38-1-134 | 300kcmil | 250 G,H FLEX | 300kcmil - 2/0 AWG | 3/8 | 0.406 | 1 to 1-3/4 | 2.625 | 2.100 | 5.312 | 1.189 | 0.414 | WHITE | I-66 | 0.812 | 0.660 |
| CLWDS-300-12-1-134 | 300kcmil | 250 G,H FLEX | 300kcmil - 2/0 AWG | 1/2 | 0.562 | 1 to 1-3/4 | 3.000 | 2.100 | 5.687 | 1.189 | 0.546 | WHITE | I-66 | 0.812 | 0.660 |

UL 486A/B, UL File E6207

All wire sizes, unless noted otherwise, are American Wire Gauge (AWG)
For Bent Tangs change the 4th letter to a B and add "-4" for 45 deg. or "-9" for 90 deg. Tested to

* When installed with specified dieless tools See pages 80 to 90 for complete tooling information.

SureCrimp Copper Compression Lugs

Slotted Tang, w/Sight Hole

Conductor Range: 1000kcmil - 250kcmil



A TYPE CSLT

Features

- Manufactured from high strength seamless copper tubing
- Electro-Tin plated
- Chamfered entry
- 2-hole tang provides maximum secureness, more contact surface and prevents rotation
- Color coded
- UL467 Listed for grounding and bonding applications,
- #8-#2 solid, 500kcmil - 8 AWG
- Suitable for use in circuits rated 35KV or less, proper high voltage spacing and insulation techniques must be used
- UL Listed and CSA Certified with nVent ILSCO and major competitor's compression tools
- For direct bury 500 kcmil - 10 grounding and bonding

Benefits

- Offers maximum conductivity and excellent crimping characteristics
- Provides low contact resistance
- For easy conductor insertion
- 2nd hole slotted to accommodate variable spacing requirements
- Identifies the proper compression die
- Application versatility
- Reduces inventory requirements

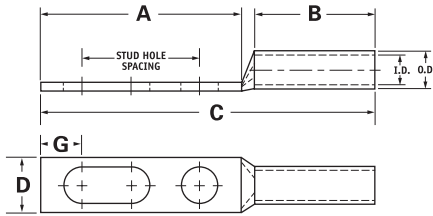

| Catalog Number | Wire Size | Alt Wire Size | Expanded* Wire Range | Bolt Size | Stud Hold Dia. | Stud Hole Spacing | Dimensions (in.) | | | | | Die Color Code | Die Index | O.D. | I.D. |
|---------------------|-----------|--------------------------------|----------------------|-----------|----------------|-------------------|------------------|-------|-------|-------|-------|----------------|-----------|-------|-------|
| | | | | | | | A | B | C | D | G | | | | |
| CLWDS-350-38-1-134 | 350kcmil | 250 I,K,M FLEX 262.2 DLO | 350kcmil - 3/0 AWG | 3/8 | 0.406 | 1 to 1-3/4 | 2.625 | 2.000 | 5.248 | 1.291 | 0.414 | RED | I-71 | 0.890 | 0.703 |
| CLWDS-350-12-1-134 | 350kcmil | 250 I,K,M FLEX 262.2 DLO | 350kcmil - 3/0 AWG | 1/2 | 0.562 | 1 to 1-3/4 | 3.000 | 2.000 | 5.623 | 1.291 | 0.546 | RED | I-71 | 0.890 | 0.703 |
| CLWDS-400-38-1-134 | 400kcmil | 300 G,H,I,K,M FLEX 313.1 DLO | 400kcmil - 4/0 AWG | 3/8 | 0.406 | 1 to 1-3/4 | 2.625 | 2.125 | 5.417 | 1.365 | 0.414 | BLUE | I-76 | 0.937 | 0.750 |
| CLWDS-400-12-1-134 | 400kcmil | 300 G,H,I,K,M FLEX 313.1 DLO | 400 kcmil - 4/0 AWG | 1/2 | 0.562 | 1 to 1-3/4 | 3.000 | 2.125 | 5.792 | 1.365 | 0.546 | BLUE | I-76 | 0.937 | 0.750 |
| CLWDS-500-12-1-134 | 500kcmil | 350 G,H,I,K,M FLEX 373.7 DLO | 500kcmil - 250kcmil | 1/2 | 0.562 | 1 to 1-3/4 | 3.000 | 2.250 | 5.982 | 1.535 | 0.546 | BROWN | I-87 | 1.064 | 0.828 |
| CLWDS-600-12-1-134 | 600kcmil | 400 G,H,I,K,M FLEX 444.4 DLO | 600kcmil - 250kcmil | 1/2 | 0.562 | 1 to 1-3/4 | 3.000 | 2.687 | 6.496 | 1.712 | 0.546 | GREEN | I-94 | 1.187 | 0.920 |
| CLWDS-650-12-1-134 | 650kcmil | 500 G,H,I,K,M FLEX 535.3 DLO | 650kcmil - 350kcmil | 1/2 | 0.562 | 1 to 1-3/4 | 3.000 | 2.687 | 6.556 | 1.764 | 0.546 | PINK | I-99 | 1.217 | 0.958 |
| CLWDS-700-12-1-134 | 700kcmil | 500 G,H,I & K,M FLEX 535.3 DLO | 700kcmil - 350kcmil | 1/2 | 0.991 | 1 to 1-3/4 | 3.000 | 2.687 | 6.556 | 1.816 | 0.546 | PINK | I-99 | 1.250 | 0.991 |
| CLWDS-750-12-1-134 | 750kcmil | 600 G,H,I,M FLEX 646.4 DLO | 750kcmil - 500kcmil | 1/2 | 0.562 | 1 to 1-3/4 | 3.000 | 2.875 | 6.777 | 1.901 | 0.546 | BLACK | I-106 | 1.313 | 1.031 |
| CLWDS-1000-12-1-134 | 1000kcmil | 750 G,H,I FLEX 777.7 DLO | 1000kcmil - 750kcmil | 1/2 | 0.562 | 1 to 1-3/4 | 3.000 | 3.000 | 7.025 | 2.169 | 0.546 | WHITE | I-125 | 1.500 | 1.172 |

Tested to UL 486A/B, UL File E6207

All wire sizes, unless noted otherwise, are American Wire Gauge (AWG)

* When installed with specified dieless tools See pages 80 to 90 for complete tooling information.

For Bent Tangs change the 4th letter to a B and add "4" for 45 deg. or "9" for 90 deg.

SureCrimp Copper Compression Lugs

Blank Tang, w/Sight Hole

Conductor Range: 1000kcmil - 6



TYPE CLWU

Features

- Manufactured from high strength seamless copper tubing
- Electro-Tin plated
- Chamfered entry
- Color coded
- UL467 Listed for grounding and bonding applications,
- #8-#2 solid, 500kcmil - 8 AWG
- Suitable for use in circuits rated 35KV or less, proper high voltage spacing and insulation techniques must be used
- UL Listed and CSA Certified with nVent ILSCO and major competitor's compression tools
- For direct bury 500 kcmil - 10 grounding and bonding

Benefits

- Offers maximum conductivity and excellent crimping characteristics
- Provides low contact resistance
- For easy conductor insertion
- Identifies the proper compression die
- Application versatility
- Reduces inventory requirements

A

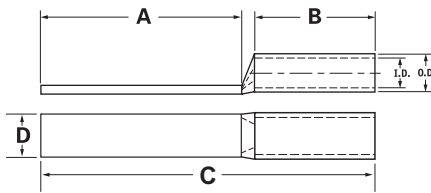

| Catalog Number | Wire Size | Alt Wire Size | Expanded* Wire Range | Dimensions (in.) | | | | Die Color Code | Die Index | O.D. | I.D. |
|----------------|-----------|--------------------------------|----------------------|------------------|-------|-------|-------|----------------|-----------|-------|-------|
| | | | | A | B | C | D | | | | |
| CLWU-6 | #6 AWG | #6 FLEX, #6 SOL | - | 3.000 | 1.130 | 4.32 | 0.760 | BLUE | I-24 | 0.312 | 0.225 |
| CLWU-4 | #4 AWG | #4 SOL | 4-6 AWG | 3.000 | 1.130 | 4.359 | 0.760 | GRAY | I-29 | 0.343 | 0.250 |
| CLWU-3 | #3 AWG | #4 FLEX | 3-6 AWG | 3.000 | 1.130 | 4.38 | 0.750 | WHITE | I-29 | 0.375 | 0.275 |
| CLWU-2 | #2 AWG | #2 SOL | 2-6 AWG | 3.000 | 1.130 | 4.411 | 0.740 | BROWN | I-33 | 0.421 | 0.312 |
| CLWU-1 | #1 AWG | #2 FLEX | 1-6 AWG | 3.000 | 1.380 | 4.705 | 0.740 | GREEN | I-37 | 0.468 | 0.359 |
| CLWU-1/0 | 1/0 AWG | #1 FLEX | 1/0-6 AWG | 3.000 | 1.500 | 4.856 | 0.740 | PINK | I-42 | 0.515 | 0.390 |
| CLWU-2/0 | 2/0 AWG | 1/0 FLEX | 2/0-4 AWG | 3.000 | 1.500 | 4.896 | 0.810 | BLACK | I-45 | 0.562 | 0.437 |
| CLWU-3/0 | 3/0 AWG | 2/0 FLEX | 3/0-2 AWG | 3.000 | 1.500 | 4.939 | 0.890 | ORANGE | I-50 | 0.609 | 0.484 |
| CLWU-4/0 | 4/0 AWG | 3/0 FLEX | 4/0-1 AWG | 3.000 | 1.500 | 4.991 | 1.000 | PURPLE | I-54 | 0.687 | 0.546 |
| CLWU-250 | 250kcmil | 4/0 FLEX | 250kcmil - 1/0 AWG | 3.000 | 1.690 | 5.219 | 1.090 | YELLOW | I-62 | 0.750 | 0.593 |
| CLWU-300 | 300kcmil | 250 G,H FLEX | 300kcmil - 2/0 AWG | 3.000 | 2.000 | 5.587 | 1.190 | WHITE | I-66 | 0.812 | 0.660 |
| CLWU-350 | 350kcmil | 250 I,K,M FLEX 262.2 DLO | 350kcmil - 3/0 AWG | 3.000 | 2.000 | 5.623 | 1.290 | RED | I-71 | 0.890 | 0.703 |
| CLWU-400 | 400kcmil | 300 G,H,I,K,M FLEX 313.1 DLO | 400kcmil - 4/0 AWG | 3.000 | 2.130 | 5.792 | 1.370 | BLUE | I-76 | 0.937 | 0.750 |
| CLWU-500 | 500kcmil | 350 G,H,I,K,M FLEX 373.7 DLO | 500kcmil - 250kcmil | 3.000 | 2.250 | 5.982 | 1.530 | BROWN | I-87 | 1.062 | 0.828 |
| CLWU-600 | 600kcmil | 400 G,H,I,K,M FLEX 444.4 DLO | 600kcmil - 250kcmil | 3.000 | 2.690 | 6.496 | 1.710 | GREEN | I-94 | 1.187 | 0.920 |
| CLWU-650 | 650kcmil | 500 G,H,I,K,M FLEX 535.3 DLO | 650kcmil - 350kcmil | 3.000 | 2.690 | 6.559 | 1.760 | PINK | I-99 | 1.217 | 0.958 |
| CLWU-700 | 700kcmil | 500 G,H,I & K,M FLEX 535.3 DLO | 700kcmil - 350kcmil | 3.000 | 2.690 | 6.556 | 1.820 | PINK | I-99 | 1.250 | 0.991 |
| CLWU-750 | 750kcmil | 600 G,H,I,M FLEX 646.4 DLO | 750kcmil - 500kcmil | 3.000 | 2.880 | 6.777 | 1.900 | BLACK | I-106 | 1.313 | 1.031 |
| CLWU-1000 | 1000kcmil | 750 G,H,I FLEX 777.7 DLO | 1000kcmil - 750kcmil | 3.000 | 3.000 | 7.025 | 2.170 | WHITE | I-125 | 1.500 | 1.172 |

Tested to UL 486A/B, UL File E6207

All wire sizes, unless noted otherwise, are American Wire Gauge (AWG)

* When installed with specified dieless tools See pages 80 to 90 for complete tooling information.

For Bent Tangs change the 4th letter to a B and add "-4" for 45 deg. or "-9" for 90 deg.

Copper Compression Lugs

Conductor Size #8

RoHS
Compliant

UL
LISTED
453G

SA
LR-29601

A

**TYPE
CCL**

Features

- Electro-tin plated
- Sight hole
- Solid seamless tang
- Electrolytic copper
- Suitable for use in circuits rated 35KV or less, proper high voltage spacing and insulation techniques must be used
- For copper conductor only
- Rated to 90° C/194° F

Benefits

- Provides low contact resistance
- Visual inspection of proper cable insertion
- For performance and strength
- For high conductivity
- Application versatility

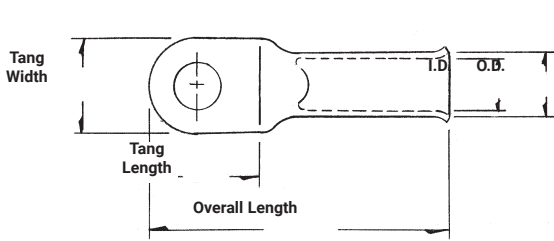

| Catalog Number | Wire Size | Alt Wire Size | Bolt Size | Tang Length | Tang Width | Tang Thickness | Overall Length | Die Color Code | I.D. | O.D. |
|----------------|-----------|---------------|-----------|-------------|------------|----------------|----------------|----------------|-------|-------|
| CCL-8-10 | 8 AWG | 8 FLEX | #8-#10 | 0.579 | 0.445 | 0.071 | 1.201 | RED | 0.185 | 0.256 |
| CCL-8-14 | 8 AWG | 8 FLEX | 1/4 | 0.579 | 0.445 | 0.071 | 1.201 | RED | 0.185 | 0.256 |
| CCL-8-516 | 8 AWG | 8 FLEX | 5/16 | 0.724 | 0.598 | 0.059 | 1.276 | RED | 0.185 | 0.256 |
| CCL-8-38 | 8 AWG | 8 FLEX | 3/8 | 0.724 | 0.598 | 0.059 | 1.276 | RED | 0.185 | 0.256 |
| CCL-8-12 | 8 AWG | 8 FLEX | 1/2 | 0.858 | 0.752 | 0.059 | 1.480 | RED | 0.185 | 0.256 |

Tooling Information

| Catalog Number | Standard Stranded Connector | | | | | Color Code |
|----------------|----------------------------------------|--------------------------------------|-----------------------------------------|----------------|--|------------|
| | nVent ILSCO | | Burndy | Thomas & Betts | | |
| | MT-25 Hand Dieless No. of Crimps | ILC-10-N Die No. No. of Crimps | MY29-3 Hand Dieless No. of Crimps | TBM8 | | |
| CCL-8 | (1) | (3) | (1) | (1) | | Red |

Tested to UL 486A/B, UL File E6207

All wire sizes, unless noted otherwise, are American Wire Gauge (AWG).

Copper Compression Lugs

Conductor Size #6

RoHS
Compliant



TYPE CCL

Features

- Electro-tin plated
- Sight hole
- Solid seamless tang
- Electrolytic copper
- Suitable for use in circuits rated 35KV or less, proper high voltage spacing and insulation techniques must be used
- For copper conductor only
- Rated to 90° C/194° F

Benefits

- Provides low contact resistance
- Visual inspection of proper cable insertion
- For performance and strength
- For high conductivity
- Application versatility

A

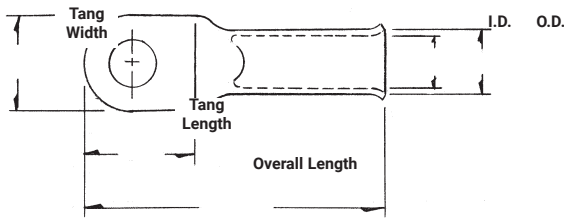

| Catalog Number | Wire Size | Alt Wire Size | Bolt Size | Tang Length | Tang Width | Tang Thickness | Overall Length | Die Color Code | I.D. | O.D. |
|----------------|-----------|---------------|-----------|-------------|------------|----------------|----------------|----------------|-------|-------|
| CCL-6-10 | 6 AWG | 6 FLEX | #10 | 0.579 | 0.445 | 0.075 | 1.268 | BLUE | 0.232 | 0.299 |
| CCL-6-14 | 6 AWG | 6 FLEX | 1/4 | 0.579 | 0.445 | 0.075 | 1.268 | BLUE | 0.232 | 0.299 |
| CCL-6-516 | 6 AWG | 6 FLEX | 5/16 | 0.724 | 0.598 | 0.067 | 1.409 | BLUE | 0.232 | 0.299 |
| CCL-6-38 | 6 AWG | 6 FLEX | 3/8 | 0.724 | 0.598 | 0.067 | 1.409 | BLUE | 0.232 | 0.299 |
| CCL-6-12 | 6 AWG | 6 FLEX | 1/2 | 0.858 | 0.752 | 0.059 | 1.551 | BLUE | 0.232 | 0.299 |

Tooling Information

| Catalog Number | Standard Stranded Connector | | | | Color Code |
|----------------|----------------------------------------|--------------------------------------|-----------------------------------------|----------------|------------|
| | nVent ILSCO | | Burndy | Thomas & Betts | |
| | MT-25 Hand Dieless No. of Crimps | ILC-10-N Die No. No. of Crimps | MY29-3 Hand Dieless No. of Crimps | TBM8 | |
| CCL-6 | (1) | (2) | (1) | (1) | Blue |

Tested to UL 486A/B, UL File E6207

All wire sizes, unless noted otherwise, are American Wire Gauge (AWG).

Copper Compression Lugs

Conductor Size #4

RoHS
Compliant

UL
LISTED
453G

SA
LR-29601

A

TYPE CCL

Features

- Electro-tin plated
- Sight hole
- Solid seamless tang
- Electrolytic copper
- Suitable for use in circuits rated 35KV or less, proper high voltage spacing and insulation techniques must be used
- For copper conductor only
- Rated to 90° C/194° F

Benefits

- Provides low contact resistance
- Visual inspection of proper cable insertion
- For performance and strength
- For high conductivity
- Application versatility

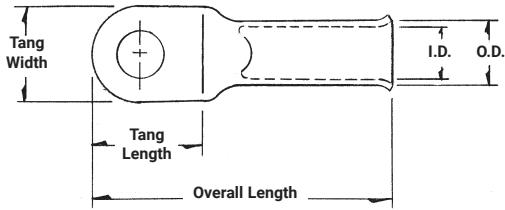

| Catalog Number | Wire Size | Alt Wire Size | Bolt Size | Tang Length | Tang Width | Tang Thickness | Overall Length | Die Color Code | I.D. | O.D. |
|----------------|-----------|---------------|-----------|-------------|------------|----------------|----------------|----------------|-------|-------|
| CCL-4-10 | 4 AWG | 4 FLEX | #10 | 0.681 | 0.516 | 0.075 | 1.496 | GRAY | 0.283 | 0.362 |
| CCL-4-14 | 4 AWG | 4 FLEX | 1/4 | 0.681 | 0.516 | 0.075 | 1.496 | GRAY | 0.283 | 0.362 |
| CCL-4-516 | 4 AWG | 4 FLEX | 5/16 | 0.728 | 0.626 | 0.075 | 1.496 | GRAY | 0.283 | 0.362 |
| CCL-4-38 | 4 AWG | 4 FLEX | 3/8 | 0.728 | 0.626 | 0.075 | 1.496 | GRAY | 0.283 | 0.362 |
| CCL-4-12 | 4 AWG | 4 FLEX | 1/2 | 0.858 | 0.752 | 0.091 | 1.681 | GRAY | 0.283 | 0.362 |

Tooling Information

| Catalog Number | Standard Stranded Connector | | | | | Color Code |
|----------------|----------------------------------------|--------------------------------------|-----------------------------------------|----------------|--|------------|
| | nVent ILSCO | | Burndy | Thomas & Betts | | |
| | MT-25 Hand Dieless No. of Crimps | ILC-10-N Die No. No. of Crimps | MY29-3 Hand Dieless No. of Crimps | TBM8 | | |
| CCL-4 | (1) | (2) | (1) | (2) | | Grey |

Tested to UL 486A/B, UL File E6207

All wire sizes, unless noted otherwise, are American Wire Gauge (AWG).

Copper Compression Lugs

Conductor Range #1-#2



TYPE CCL

Features

- Electro-tin plated
- Sight hole
- Solid seamless tang
- Electrolytic copper
- Suitable for use in circuits rated 35KV or less, proper high voltage spacing and insulation techniques must be used
- For copper conductor only
- Rated to 90° C/194° F

Benefits

- Provides low contact resistance
- Visual inspection of proper cable insertion
- For performance and strength
- For high conductivity
- Application versatility

A

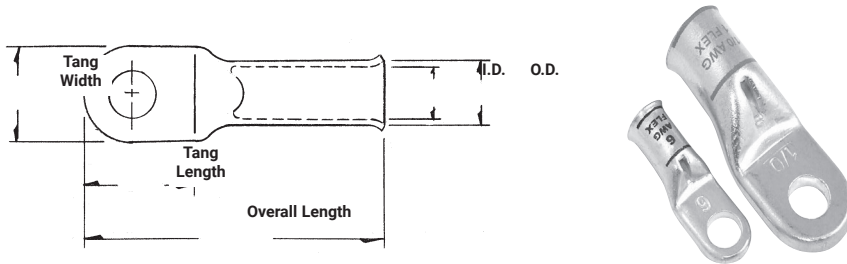

| Catalog Number | Wire Size | Alt Wire Size | Bolt Size | Tang Length | Tang Width | Tang Thickness | Overall Length | Die Color Code | I.D. | O.D. |
|----------------|-----------|---------------|-----------|-------------|------------|----------------|----------------|----------------|-------|-------|
| CCL-2-14 | 2 AWG | 3 FLEX | 1/4 | 0.728 | 0.598 | 0.094 | 1.606 | BROWN | 0.335 | 0.429 |
| CCL-2-516 | 2 AWG | 3 FLEX | 5/16 | 0.728 | 0.598 | 0.094 | 1.606 | BROWN | 0.335 | 0.429 |
| CCL-2-38 | 2 AWG | 3 FLEX | 3/8 | 0.728 | 0.598 | 0.094 | 1.606 | BROWN | 0.335 | 0.429 |
| CCL-2-12 | 2 AWG | 3 FLEX | 1/2 | 0.858 | 0.752 | 0.102 | 1.752 | BROWN | 0.335 | 0.429 |
| CCL-1-14 | 1 AWG | 2 FLEX | 1/4 | 0.858 | 0.650 | 0.098 | 1.720 | GREEN | 0.362 | 0.461 |
| CCL-1-516 | 1 AWG | 2 FLEX | 5/16 | 0.858 | 0.650 | 0.098 | 1.720 | GREEN | 0.362 | 0.461 |
| CCL-1-38 | 1 AWG | 2 FLEX | 3/8 | 0.858 | 0.650 | 0.098 | 1.720 | GREEN | 0.362 | 0.461 |
| CCL-1-12 | 1 AWG | 2 FLEX | 1/2 | 0.858 | 0.752 | 0.102 | 1.831 | GREEN | 0.362 | 0.461 |

Tooling Information

| Catalog Number | Standard Stranded Connector | | | | Color Code |
|----------------|----------------------------------|--------------------------------|-----------------------------------|----------------|------------|
| | nVent ILSCO | | Burndy | Thomas & Betts | |
| | MT-25 Hand Dieless No. of Crimps | ILC-10-N Die No. No. of Crimps | MY29-3 Hand Dieless No. of Crimps | TBM8 | |
| CCL-2 | (1) | (2) | (2) | (2) | Brown |
| CCL-1 | (1) | (2) | (2) | (2) | Green |

Tested to UL 486A/B, UL File E6207

All wire sizes, unless noted otherwise, are American Wire Gauge (AWG).

Copper Compression Lugs

Conductor Range 2/0-1/0

RoHS
Compliant

UL
LISTED
453G

SA
LR-29601

A

TYPE CCL

Features

- Electro-tin plated
- Sight hole
- Solid seamless tang
- Electrolytic copper
- Suitable for use in circuits rated 35KV or less, proper high voltage spacing and insulation techniques must be used
- For copper conductor only
- Rated to 90° C/194° F

Benefits

- Provides low contact resistance
- Visual inspection of proper cable insertion
- For performance and strength
- For high conductivity
- Application versatility

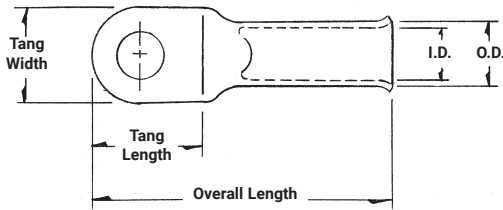

| Catalog Number | Wire Size | Alt Wire Size | Bolt Size | Tang Length | Tang Width | Tang Thickness | Overall Length | Die Color Code | I.D. | O.D. |
|----------------|-----------|---------------|-----------|-------------|------------|----------------|----------------|----------------|-------|-------|
| CCL-1/0-14 | 1/0 AWG | 1 FLEX | 1/4 | 0.791 | 0.713 | 0.110 | 1.831 | PINK | 0.406 | 0.516 |
| CCL-1/0-516 | 1/0 AWG | 1 FLEX | 5/16 | 0.791 | 0.713 | 0.110 | 1.831 | PINK | 0.406 | 0.516 |
| CCL-1/0-38 | 1/0 AWG | 1 FLEX | 3/8 | 0.791 | 0.713 | 0.110 | 1.831 | PINK | 0.406 | 0.516 |
| CCL-1/0-12 | 1/0 AWG | 1 FLEX | 1/2 | 0.890 | 0.815 | 0.110 | 1.902 | PINK | 0.406 | 0.516 |
| CCL-2/0-14 | 2/0 AWG | 1/0 FLEX | 1/4 | 0.929 | 0.815 | 0.110 | 2.055 | BLACK | 0.461 | 0.571 |
| CCL-2/0-516 | 2/0 AWG | 1/0 FLEX | 5/16 | 0.929 | 0.815 | 0.110 | 2.055 | BLACK | 0.461 | 0.571 |
| CCL-2/0-38 | 2/0 AWG | 1/0 FLEX | 3/8 | 0.929 | 0.815 | 0.110 | 2.055 | BLACK | 0.461 | 0.571 |
| CCL-2/0-12 | 2/0 AWG | 1/0 FLEX | 1/2 | 0.929 | 0.815 | 0.110 | 2.055 | BLACK | 0.461 | 0.571 |

Tooling Information

| Catalog Number | Standard Stranded Connector | | | | Color Code |
|----------------|----------------------------------------|--------------------------------------|-----------------------------------------|----------------|------------|
| | nVent ILSCO | | Burndy | Thomas & Betts | |
| | MT-25 Hand Dieless No. of Crimps | ILC-10-N Die No. No. of Crimps | MY29-3 Hand Dieless No. of Crimps | TBM8 | |
| CCL-1/0 | (1) | (2) | (2) | (2) | Pink |
| CCL-2/0 | (1) | - | (2) | (2) | |

Tested to UL 486A/B, UL File E6207

All wire sizes, unless noted otherwise, are American Wire Gauge (AWG).

Copper Compression Lugs

Conductor Range 4/0-3/0

RoHS
Compliant



TYPE
CCL

Features

- Electro-tin plated
- Sight hole
- Solid seamless tang
- Electrolytic copper
- Suitable for use in circuits rated 35KV or less, proper high voltage spacing and insulation techniques must be used
- For copper conductor only
- Rated to 90° C/194° F

Benefits

- Provides low contact resistance
- Visual inspection of proper cable insertion
- For performance and strength
- For high conductivity
- Application versatility

A

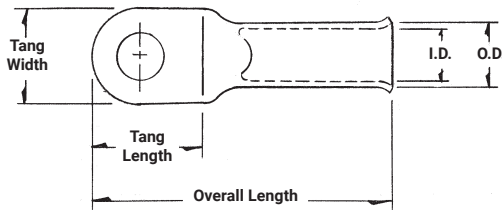

| Catalog Number | Wire Size | Alt Wire Size | Bolt Size | Tang Length | Tang Width | Tang Thickness | Overall Length | Die Color Code | I.D. | O.D. |
|----------------|-----------|---------------|-----------|-------------|------------|----------------|----------------|----------------|-------|-------|
| CCL-3/0-14 | 3/0 AWG | 2/0 FLEX | 1/4 | 0.969 | 0.894 | 0.118 | 2.161 | ORANGE | 0.512 | 0.630 |
| CCL-3/0-516 | 3/0 AWG | 2/0 FLEX | 5/16 | 0.969 | 0.894 | 0.118 | 2.161 | ORANGE | 0.512 | 0.630 |
| CCL-3/0-38 | 3/0 AWG | 2/0 FLEX | 3/8 | 0.969 | 0.894 | 0.118 | 2.161 | ORANGE | 0.512 | 0.630 |
| CCL-3/0-12 | 3/0 AWG | 2/0 FLEX | 1/2 | 0.969 | 0.894 | 0.118 | 2.161 | ORANGE | 0.512 | 0.630 |
| CCL-4/0-14 | 4/0 AWG | 3/0 FLEX | 1/4 | 1.071 | 1.035 | 0.130 | 2.382 | PURPLE | 0.591 | 0.720 |
| CCL-4/0-516 | 4/0 AWG | 3/0 FLEX | 5/16 | 1.071 | 1.035 | 0.130 | 2.382 | PURPLE | 0.591 | 0.720 |
| CCL-4/0-38 | 4/0 AWG | 3/0 FLEX | 3/8 | 1.071 | 1.035 | 0.130 | 2.382 | PURPLE | 0.591 | 0.720 |
| CCL-4/0-12 | 4/0 AWG | 3/0 FLEX | 1/2 | 1.071 | 1.035 | 0.130 | 2.382 | PURPLE | 0.591 | 0.720 |

Tooling Information

| Catalog Number | Standard Stranded Connector | | | | Color Code |
|----------------|----------------------------------|--------------------------------|-----------------------------------|----------------|------------|
| | nVent ILSCO | | Burndy | Thomas & Betts | |
| | MT-25 Hand Dieless No. of Crimps | ILC-10-N Die No. No. of Crimps | MY29-3 Hand Dieless No. of Crimps | TBM8 | |
| CCL-3/0 | (1) | - | (2) | (2) | |
| CCL-4/0 | (2) | - | (2) | (2) | |

Tested to UL 486A/B, UL File E6207

All wire sizes, unless noted otherwise, are American Wire Gauge (AWG).

Copper Mining Lugs

For copper conductor only

RoHS
Compliant

UL
LISTED
453G

SA
LR-29601

A TYPE CRA

Features

- Electro-tin plated
- Sight hole
- Solid seamless tang
- Electrolytic copper
- Suitable for use in circuits rated 35KV or less, proper high voltage spacing and insulation techniques must be used
- Rated to 90° C/194° F

Benefits

- Provides low contact resistance
- Visual inspection of proper cable insertion
- For performance and strength
- For high conductivity
- Application versatility

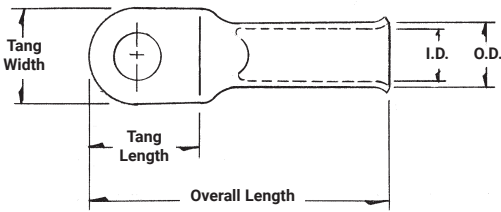

| Catalog Number | Wire Size | Alt Wire Size | Bolt Size | Tang Length | Tang Width | Tang Thickness | Overall Length | Die Color Code | I.D. | O.D. |
|----------------|-----------|---------------|-----------|-------------|------------|----------------|----------------|----------------|-------|-------|
| CRA-8-8/10M | 8 FLEX | 8 AWG | #8-#10 | 0.579 | 0.445 | 0.071 | 1.201 | RED | 0.185 | 0.256 |
| CRA-8-14M | 8 FLEX | 8 AWG | 1/4 | 0.579 | 0.445 | 0.071 | 1.201 | RED | 0.185 | 0.256 |
| CRA-8-516M | 8 FLEX | 8 AWG | 5/16 | 0.724 | 0.598 | 0.059 | 1.276 | RED | 0.185 | 0.256 |
| CRA-8-38M | 8 FLEX | 8 AWG | 3/8 | 0.724 | 0.598 | 0.059 | 1.276 | RED | 0.185 | 0.256 |
| CRA-8-12M | 8 FLEX | 8 AWG | 1/2 | 0.858 | 0.752 | 0.059 | 1.480 | RED | 0.185 | 0.256 |
| CRA-6-10M | 6 FLEX | 6 AWG | #10 | 0.579 | 0.445 | 0.075 | 1.268 | BLUE | 0.232 | 0.299 |
| CRA-6-14M | 6 FLEX | 6 AWG | 1/4 | 0.579 | 0.445 | 0.075 | 1.268 | BLUE | 0.232 | 0.299 |
| CRA-6-516-M | 6 FLEX | 6 AWG | 5/16 | 0.724 | 0.598 | 0.067 | 1.409 | BLUE | 0.232 | 0.299 |
| CRA-6-38M | 6 FLEX | 6 AWG | 3/8 | 0.724 | 0.598 | 0.067 | 1.409 | BLUE | 0.232 | 0.299 |
| CRA-6-12M | 6 FLEX | 6 AWG | 1/2 | 0.858 | 0.752 | 0.059 | 1.551 | BLUE | 0.232 | 0.299 |
| CRA-4-10M | 4 FLEX | 4 AWG | #10 | 0.681 | 0.516 | 0.075 | 1.496 | GRAY | 0.283 | 0.362 |
| CRA-4-14M | 4 FLEX | 4 AWG | 1/4 | 0.681 | 0.516 | 0.075 | 1.496 | GRAY | 0.283 | 0.362 |
| CRA-4-516M | 4 FLEX | 4 AWG | 5/16 | 0.728 | 0.626 | 0.075 | 1.496 | GRAY | 0.283 | 0.362 |
| CRA-4-38M | 4 FLEX | 4 AWG | 3/8 | 0.728 | 0.626 | 0.075 | 1.496 | GRAY | 0.283 | 0.362 |
| CRA-4-12M | 4 FLEX | 4 AWG | 1/2 | 0.858 | 0.752 | 0.091 | 1.681 | GRAY | 0.283 | 0.362 |
| CRA-2-14M | 2 FLEX | 1 AWG | 1/4 | 0.858 | 0.650 | 0.098 | 1.720 | GREEN | 0.362 | 0.461 |
| CRA-2-516M | 2 FLEX | 1 AWG | 5/16 | 0.858 | 0.650 | 0.098 | 1.720 | GREEN | 0.362 | 0.461 |
| CRA-2-38M | 2 FLEX | 1 AWG | 3/8 | 0.858 | 0.650 | 0.098 | 1.720 | GREEN | 0.362 | 0.461 |
| CRA-2-12M | 2 FLEX | 1 AWG | 1/2 | 0.858 | 0.752 | 0.102 | 1.831 | GREEN | 0.362 | 0.461 |

Tooling Information

| Flex Size | AWG Size | nVent ILSCO | Burndy |
|-----------|-----------|--------------------------------------|---------------------------------------|
| | | MT-25 Hand Dieless (A) No. of Crimps | MY29-3 Hand Dieless (A) No. of Crimps |
| 8 | 8 | (1) | (1) |
| 6 | 6 | (1) | (1) |
| 4 | 4 | (1) | (1) |
| 2 | 1 | (1) | (2) |
| 4/0 | 250 kcmil | (2) | (2) |

Tested to UL 486A/B, UL File E6207. All wire sizes, unless noted otherwise, are American Wire Gauge (AWG).

Copper Mining Lugs

For copper conductor only

RoHS
Compliant



TYPE CRA

Features

- Electro-tin plated
- Sight hole
- Solid seamless tang
- Electrolytic copper
- Suitable for use in circuits rated 35KV or less, proper high voltage spacing and insulation techniques must be used
- Rated to 90° C/194° F

Benefits

- Provides low contact resistance
- Visual inspection of proper cable insertion
- For performance and strength
- For high conductivity
- Application versatility

A

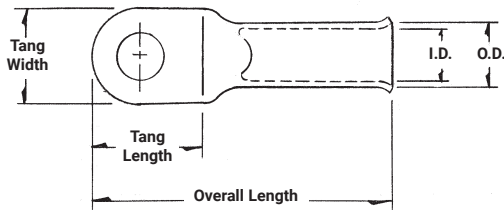

| Catalog Number | Wire Size | Alt Wire Size | Bolt Size | Tang Length | Tang Width | Tang Thickness | Overall Length | Die Color Code | I.D. | O.D. |
|----------------|-----------|---------------|-----------|-------------|------------|----------------|----------------|----------------|-------|-------|
| CRA-1-14M | 1 FLEX | 1/0 AWG | 1/4 | 0.791 | 0.713 | 0.110 | 1.831 | PINK | 0.406 | 0.51 |
| CRA-1-516M | 1 FLEX | 1/0 AWG | 5/16 | 0.791 | 0.713 | 0.110 | 1.831 | PINK | 0.406 | 0.516 |
| CRA-1-38M | 1 FLEX | 1/0 AWG | 3/8 | 0.791 | 0.713 | 0.110 | 1.831 | PINK | 0.406 | 0.516 |
| CRA-1-12M | 1 FLEX | 1/0 AWG | 1/2 | 0.890 | 0.815 | 0.110 | 1.902 | PINK | 0.406 | 0.516 |
| CRA-1/0-14M | 1/0 FLEX | 2/0 AWG | 1/4 | 0.929 | 0.815 | 0.110 | 2.055 | BLACK | 0.461 | 0.571 |
| CRA-1/0-516M | 1/0 FLEX | 2/0 AWG | 5/16 | 0.929 | 0.815 | 0.110 | 2.055 | BLACK | 0.461 | 0.571 |
| CRA-1/0-38M | 1/0 FLEX | 2/0 AWG | 3/8 | 0.929 | 0.815 | 0.110 | 2.055 | BLACK | 0.461 | 0.571 |
| CRA-1/0-12M | 1/0 FLEX | 2/0 AWG | 1/2 | 0.929 | 0.815 | 0.110 | 2.055 | BLACK | 0.461 | 0.571 |
| CRA-2/0-14M | 2/0 FLEX | 3/0 AWG | 1/4 | 0.969 | 0.894 | 0.118 | 2.161 | ORANGE | 0.512 | 0.630 |
| CRA-2/0-516M | 2/0 FLEX | 3/0 AWG | 5/16 | 0.969 | 0.894 | 0.118 | 2.161 | ORANGE | 0.512 | 0.630 |
| CRA-2/0-38-M | 2/0 FLEX | 3/0 AWG | 3/8 | 0.969 | 0.894 | 0.118 | 2.161 | ORANGE | 0.512 | 0.630 |
| CRA-2/0-12M | 2/0 FLEX | 3/0 AWG | 1/2 | 0.969 | 0.894 | 0.118 | 2.161 | ORANGE | 0.512 | 0.630 |
| CRA-3/0-38M | 3/0 FLEX | 4/0 AWG | 3/8 | 1.071 | 1.035 | 0.130 | 2.382 | PURPLE | 0.591 | 0.720 |
| CRA-3/0-12M | 3/0 FLEX | 4/0 AWG | 1/2 | 1.071 | 1.035 | 0.130 | 2.382 | PURPLE | 0.591 | 0.720 |
| CRA-4/0-38M | 4/0 FLEX | 250 kcmil | 3/8 | 1.228 | 1.201 | 0.130 | 2.614 | YELLOW | 0.685 | 0.815 |
| CRA-4/0-12M | 4/0 FLEX | 250 kcmil | 1/2 | 1.228 | 1.201 | 0.130 | 2.614 | YELLOW | 0.685 | 0.815 |

Tooling Information

| Flex Size | AWG Size | nVent ILSCO | Burndy |
|-----------|-----------|--------------------------------------|---------------------------------------|
| | | MT-25 Hand Dieless (A) No. of Crimps | MY29-3 Hand Dieless (A) No. of Crimps |
| 1 | 1/0 | (1) | (2) |
| 1/0 | 2/0 | (1) | (2) |
| 2/0 | 3/0 | (1) | (2) |
| 3/0 | 4/0 | (2) | (2) |
| 4/0 | 250 kcmil | (2) | (2) |

Tested to UL 486A/B, UL File E6207

All wire sizes, unless noted otherwise, are American Wire Gauge (AWG).

Copper Soldering Lugs

One Hole

RoHS
Compliant

UL
LISTED
453G

SA
LR-29601

A

TYPE Solder Lugs

Features

- Manufactured from high strength copper tubing
- Seamless construction
- Clearly marked with wire size
- Suitable for use in circuits rated 35KV or less, proper high voltage spacing and insulation techniques must be used
- Rated to 90° C/194° F

Benefits

- Provides maximum conductivity
- Won't leak solder
- Provides easy identification
- Application versatility

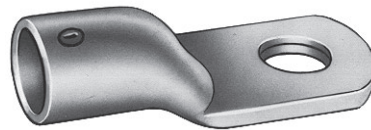
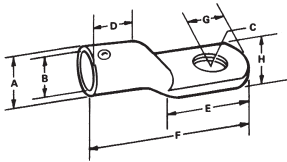

Fig. 1

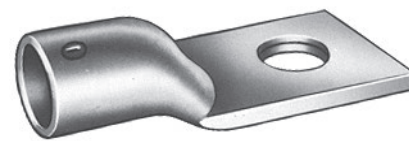

Fig. 2

| Catalog Number A | Figure Number | Wire Size | Dimensions (in.) | | | | | | | | Amp Rating |
|------------------|---------------|-----------|------------------|-----------|-------|---------|--------|---------|-------|---------|------------|
| | | | B | Bolt Size | C | D | E | F | G | H | |
| 3/16 | 1 | 10 | 9/64 | #8 | 11/64 | 11/32 | 15/32 | 15/16 | 3/16 | 1/4 | 25 Amp |
| 1/4 | 1 | 8 | 3/16 | #10 | 13/64 | 11/32 | 1/2 | 1-1/32 | 7/32 | 3/8 | 35 Amp |
| 5/16 | 1 | 6 | 15/64 | #10 | 13/64 | 13/32 | 19/32 | 1-7/32 | 1/4 | 7/16 | 50 Amp |
| 3/8 | 1 | 4 | 9/32 | 1/4 | 9/32 | 7/16 | 11/16 | 1-3/8 | 9/32 | 17/32 | 70 Amp |
| 7/16 | 1 | 2 | 11/32 | 1/4 | 9/32 | 1/2 | 3/4 | 1-1/2 | 11/32 | 5/8 | 90 Amp |
| 1/2 | 1 | 1/0 | 25/64 | 5/16 | 11/32 | 9/16 | 13/16 | 1-3/4 | 13/32 | 3/4 | 125 Amp |
| 9/16 | 1 | 2/0 | 15/32 | 3/8 | 13/32 | 11/16 | 15/16 | 2 | 7/16 | 13/16 | 150 Amp |
| 5/8 | 1 | 3/0 | 33/64 | 3/8 | 13/32 | 25/32 | 1 | 2-1/8 | 1/2 | 29/32 | 175 Amp |
| 11/16 | 1 | 4/0 | 9/16 | 3/8 | 13/32 | 27/32 | 1-5/32 | 2-3/8 | 17/32 | 31/32 | 225 Amp |
| 13/16 | 1 | 250kcmil | 43/64 | 3/8 | 13/32 | 31/32 | 1-1/4 | 2-21/32 | 5/8 | 1-3/16 | 250 Amp |
| 1-1/8 | 2 | 600kcmil | 61/64 | 3/8 | 13/32 | 1-1/2 | 2-1/4 | 4-7/16 | 1 | 1-5/8 | 450 Amp |
| 1-5/16 | 2 | 800kcmil | 1-3/32 | 1/2 | 17/32 | 1-13/16 | 2-1/2 | 5-1/16 | 1-1/8 | 1-15/16 | 550 Amp |

Tested to UL 486A/B, UL File E6207

All wire sizes, unless noted otherwise, are American Wire Gauge (AWG).

SureCrimp Copper Compression Sleeves

Short Barrel

Conductor Range: 1000kcmil-#8



TYPE CT

Features

- Manufactured from high strength seamless copper tubing
- Electro-Tin plated
- Chamfered entry
- Color coded
- Suitable for use in circuits rated 35KV or less, proper high voltage spacing and insulation techniques must be used
- UL Listed and CSA Certified with nVent ILSCO and major competitor's compression tools
- UL467 Listed 500 kcmil - 8 AWG , #8 - #2 SOL
- For direct bury 500 kcmil - 10 grounding and bonding
- Rated to 90° C/194° F

Benefits

- Offers maximum conductivity and excellent crimping characteristics
- Provides low contact resistance
- For easy conductor insertion
- Identifies the proper compression die
- Application versatility
- Reduces inventory requirements
- For grounding and bonding applications

A

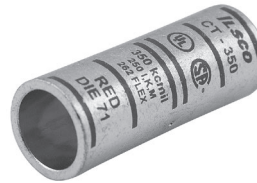
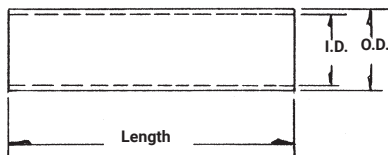

| Catalog Number | Wire Size | Alt Wire Size | Expanded* Wire Size | Barrel Length | Die Color Code | Die Index | Die Catalog Number | O.D. | I.D. |
|----------------|-----------|------------------------------|---------------------|---------------|----------------|-----------|--------------------|-------|-------|
| CT-8 | 8 AWG | #8 Flex, #8 Sol | - | 1.125 | Red | I-21 | ILD-21 | 0.272 | 0.179 |
| CT-6 | 6 AWG | #6 Flex, #6 Sol | - | 1.750 | Blue | I-24-1 | ILD-24 | 0.320 | 0.225 |
| CT-4 | 4 AWG | #4 Sol | 4-6 AWG | 1.750 | Gray | I-29-1 | ILD-29 | 0.343 | 0.250 |
| CT-3 | 3 AWG | #4 Flex | 3-6 AWG | 1.750 | White | I-29-1 | ILD-29 | 0.375 | 0.275 |
| CT-2 | 2 AWG | #2 Sol | 2-6 AWG | 1.875 | Brown | I-33 | ILD-33 | 0.421 | 0.312 |
| CT-1 | 1 AWG | #2 Flex | 1-6 AWG | 1.875 | Green | I-37 | ILD-37 | 0.468 | 0.359 |
| CT-1/0 | 1/0 AWG | #1 Flex | 1/0-6 AWG | 1.875 | Pink | I-42 | ILD-42 | 0.515 | 0.390 |
| CT-2/0 | 2/0 AWG | 1/0 Flex | 2/0-4 AWG | 2.000 | Black | I-45 | ILD-45 | 0.562 | 0.437 |
| CT-3/0 | 3/0 AWG | 2/0 Flex | 3/0-2 AWG | 2.125 | Orange | I-50 | ILD-50 | 0.609 | 0.484 |
| CT-4/0 | 4/0 AWG | 3/0 Flex | 4/0-1 AWG | 2.125 | Purple | I-54 | ILD-54 | 0.687 | 0.546 |
| CT-250 | 250kcmil | 4/0 Flex | 250kcmil-1/0 AWG | 2.250 | Yellow | I-62 | ILD-62 | 0.750 | 0.593 |
| CT-300 | 300kcmil | 250 G,H Flex | 300kcmil-2/0 AWG | 2.250 | White | I-66 | ILD-66 | 0.812 | 0.660 |
| CT-350 | 350kcmil | 250 I,K,M Flex 262.2 DLO | 350kcmil-3/0 AWG | 2.375 | Red | I-71 | ILD-71 | 0.890 | 0.703 |
| CT-400 | 400kcmil | 300 G,H,I,K,M Flex 313.1 DLO | 400kcmil-4/0 AWG | 2.500 | Blue | I-76 | ILD-76 | 0.937 | 0.750 |
| CT-500 | 500kcmil | 350 G,H,I,K,M Flex 373.7 DLO | 500kcmil-250kcmil | 2.875 | Brown | I-87 | ILD-87 | 1.062 | 0.828 |
| CT-600 | 600kcmil | 400 G,H,I,K,M Flex 444.4 DLO | 600kcmil-250kcmil | 2.875 | Green | I-94 | ILD-94 | 1.187 | 0.920 |
| CT-650 | 650kcmil | 500 G,H,I,K,M Flex 535.3 DLO | 650kcmil-350kcmil | 2.875 | Pink | I-99 | ILD-99 | 1.222 | 0.962 |
| CT-700 | 700kcmil | 500 G,H,I,K,M Flex 535.3 DLO | 700kcmil-350kcmil | 3.375 | Pink | I-99 | ILD-99 | 1.250 | 0.991 |
| CT-750 | 750kcmil | 600 G,H,I,M Flex 646.4 DLO | 750kcmil-500kcmil | 3.375 | Black | I-106 | ILD-106 | 1.313 | 1.031 |
| CT-1000 | 1000kcmil | 750 G,H,I Flex 777.7 DLO | 1000kcmil-750kcmil | 3.875 | White | I-125 | ILD-125 | 1.500 | 1.172 |

Tested to UL 486A/B, UL File E6207

All wire sizes, unless noted otherwise, are American Wire Gauge (AWG)

* When installed with specified dieless tools

See pages 80 to 90 for complete tooling information.

SureCrimp Copper Compression Sleeves

Long Barrel

Conductor Range: 1000kcmil-#6



A

TYPE CTL

Features

- Manufactured from high strength seamless copper tubing
- Electro-Tin plated
- Chamfered entry
- Color coded
- Suitable for use in circuits rated 35KV or less, proper high voltage spacing and insulation techniques must be used
- UL Listed and CSA Certified with nVent ILSCO and major competitor's compression tools
- UL467 Listed 500 kcmil - 8 AWG , #8 - #2 SOL
- For direct bury 500 kcmil - 10 grounding and bonding
- Rated to 90° C/194° F

Benefits

- Offers maximum conductivity and excellent crimping characteristics
- Provides low contact resistance
- For easy conductor insertion
- Identifies the proper compression die
- Application versatility
- Reduces inventory requirements
- For grounding and bonding applications

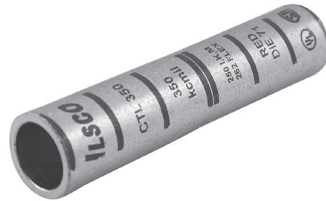
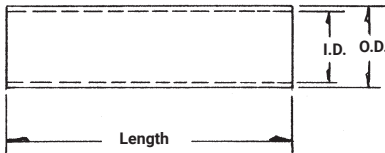

| Catalog Number | Wire Size | Alt Wire Size | Expanded* Wire Size | Barrel Length | Die Color Code | Die Index | Die Catalog Number | O.D. | I.D. |
|----------------|-----------|------------------------------|---------------------|---------------|----------------|-----------|--------------------|-------|-------|
| CTL-8 | 8 AWG | #8 Flex, #8 Sol | - | 1.75 | Red | I-21 | ILD-21 | 0.272 | 0.179 |
| CTL-6 | 6 AWG | #6 Flex, #6 Sol | - | 2.375 | Blue | I-24 | ILD-24-1 | 0.320 | 0.225 |
| CTL-4 | 4 AWG | #4 Sol | 4-6 AWG | 2.375 | Gray | I-29 | ILD-29-1 | 0.343 | 0.250 |
| CTL-3 | 3 AWG | #4 Flex | 3-6 AWG | 2.375 | White | I-29 | ILD-29-1 | 0.375 | 0.275 |
| CTL-2 | 2 AWG | #2 Sol | 2-6 AWG | 2.625 | Brown | I-33 | ILD-33 | 0.421 | 0.312 |
| CTL-1 | 1 AWG | #2 Flex | 1-6 AWG | 2.875 | Green | I-37 | ILD-37 | 0.468 | 0.359 |
| CTL-1/0 | 1/0 AWG | #1 Flex | 1/0-6 AWG | 2.875 | Pink | I-42 | ILD-42 | 0.515 | 0.390 |
| CTL-2/0 | 2/0 AWG | 1/0 Flex | 2/0-4 AWG | 3.125 | Black | I-45 | ILD-45 | 0.562 | 0.437 |
| CTL-3/0 | 3/0 AWG | 2/0 Flex | 3/0-2 AWG | 3.125 | Orange | I-50 | ILD-50 | 0.609 | 0.484 |
| CTL-4/0 | 4/0 AWG | 3/0 Flex | 4/0-1 AWG | 3.375 | Purple | I-54 | ILD-54 | 0.687 | 0.546 |
| CTL-250 | 250kcmil | 4/0 Flex | 250kcmil-1/0 AWG | 3.375 | Yellow | I-62 | ILD-62 | 0.750 | 0.593 |
| CTL-300 | 300kcmil | 250 G,H Flex | 300kcmil-2/0 AWG | 4.125 | White | I-66 | ILD-66 | 0.812 | 0.660 |
| CTL-350 | 350kcmil | 250 I,K,M Flex 262.2 DLO | 350kcmil-3/0 AWG | 4.125 | Red | I-71 | ILD-71 | 0.890 | 0.703 |
| CTL-400 | 400kcmil | 300 G,H,I,K,M Flex 313.1 DLO | 400kcmil-4/0 AWG | 4.375 | Blue | I-76 | ILD-76 | 0.937 | 0.750 |
| CTL-500 | 500kcmil | 350 G,H,I,K,M Flex 373.7 DLO | 500kcmil-250kcmil | 4.625 | Brown | I-87 | ILD-87 | 1.062 | 0.828 |
| CTL-600 | 600kcmil | 400 G,H,I,K,M Flex 444.4 DLO | 600kcmil-250kcmil | 4.625 | Green | I-94 | ILD-94 | 1.187 | 0.920 |
| CTL-650 | 650kcmil | 500 G,H,I,K,M Flex 535.3 DLO | 650kcmil-350kcmil | 4.625 | Pink | I-99 | ILD-99 | 1.222 | 0.962 |
| CTL-700 | 700kcmil | 500 G,H,I,K,M Flex 535.3 DLO | 700kcmil-350kcmil | 5.875 | Pink | I-99 | ILD-99 | 1.250 | 0.991 |
| CTL-750 | 750kcmil | 600 G,H,I,M Flex 646.4 DLO | 750kcmil-500kcmil | 5.875 | Black | I-106 | ILD-106 | 1.313 | 1.031 |
| CTL-1000 | 1000kcmil | 750 G,H,I Flex 777.7 DLO | 1000kcmil-750kcmil | 6.125 | White | I-125 | ILD-125 | 1.500 | 1.172 |

Tested to UL 486A/B, UL File E6207

All wire sizes, unless noted otherwise, are American Wire Gauge (AWG)

* When installed with specified dieless tools See pages 80 to 90 for complete tooling information.

For Bent Tangs change the 4th letter to a B and add "4" for 45 deg. or "9" for 90 deg.

Copper Compression Sleeves

Light Duty

RoHS
Compliant



TYPE
CCS

Features

- Manufactured from high strength copper
- Electro-tin plated
- Suitable for use in circuits rated 35KV or less, proper high voltage spacing and insulation techniques must be used
- Color coded
- Sight hole
- Flared end
- Rated to 90° C/194° F

Benefits

- Provides maximum conductivity and excellent crimping characteristics
- Provides low contact resistance
- Application versatility
- Provides visual tooling recommendation for nVent ILSCO or standard industry tools
- Allows visual inspection
- Easy wire insertion

A

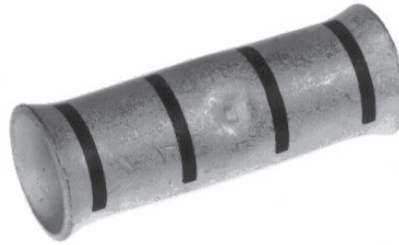
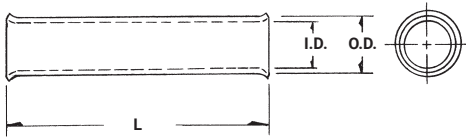

| Catalog Number | Wire Size | Die Color Guide | L | O.D. | I.D. |
|----------------|-----------|-----------------|---------|-------|-------|
| CCS-6 | 6 | Blue | 1-1/16 | 5/16 | 15/64 |
| CCS-4 | 4 | Grey | 1-13/64 | 23/64 | 9/32 |
| CCS-2 | 2 | Brown | 1-23/64 | 7/16 | 21/64 |
| CCS-1 | 1 | Green | 1-23/64 | 15/32 | 23/64 |
| CCS-1/0 | 1/0 | Pink | 1-35/64 | 33/64 | 13/32 |
| CCS-2/0 | 2/0 | Black | 1-51/64 | 37/64 | 15/32 |
| CCS-3/0 | 3/0 | Orange | 1-29/32 | 5/8 | 33/64 |
| CCS-4/0 | 4/0 | Purple | 2 | 11/16 | 9/16 |

UL File E158587

All wire sizes, unless noted otherwise, are American Wire Gauge (AWG)

SureCrimp Aluminum Compression Lugs

Long Barrel - Standard Tang - Dual Rated, Conductor Range: 4/0 - #8



A TYPE ALNS

Features

- Manufactured from high strength aluminum alloy
- Electro-Tin plated
- Chamfered entry
- Color coded end cap
- Ink marked
- Pre-filled with De-Ox oxide inhibiting compound
- Range taking
- Suitable for use in circuits rated 35KV or less, proper high voltage spacing and insulation techniques must be used
- Dual rated AL9CU to 90° C/194° F

Benefits

- Offers maximum conductivity and excellent crimping characteristics
- Provides low contact resistance
- For easy conductor insertion
- Identifies the proper conductor size
- For easy identification and proper location of crimps
- Prevents oxides from forming & promotes connector longevity
- Permits inventories to be kept to a minimum
- Application versatility
- For use with aluminum or copper conductor

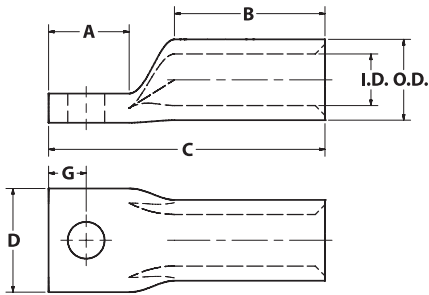

| Catalog Number | Wire Size | Expanded Wire Size* | Bolt Size | Stud Hole Dia. | Dimensions - in. (mm) | | | | | O.D. | I.D. | Die Color Code | Die Index |
|----------------|-----------|---------------------|-----------|----------------|-----------------------|--------------|---------------|--------------|--------------|--------------|--------------|----------------|-----------|
| | | | | | A | B | C | D | G | | | | |
| ALNS-8-10 | #8 AWG | - | #10 | 0.219 (5.6) | 0.661 (16.8) | 0.602 (15.3) | 1.470 (37.3) | 0.388 (9.9) | 0.259 (6.6) | 0.300 (7.6) | 0.155 (3.9) | Blue | 374 |
| ALNS-6-14 | #6 AWG | - | 1/4 | 0.281 (7.1) | 0.895 (22.7) | 0.602 (15.3) | 1.860 (47.2) | 0.449 (11.4) | 0.321 (8.1) | 0.338 (8.6) | 0.194 (4.9) | Gray | 346 |
| ALNS-4-14 | #4 AWG | 4-6 AWG | 1/4 | 0.281 (7.1) | 1.029 (26.1) | 0.920 (23.4) | 2.170 (55.1) | 0.568 (14.4) | 0.321 (8.1) | 0.427 (10.8) | 0.247 (6.3) | Green | 375 |
| ALNS-4-516 | #4 AWG | 4-6 AWG | 5/16 | 0.343 (8.7) | 0.937 (23.8) | 0.920 (23.4) | 2.170 (55.1) | 0.568 (14.4) | 0.353 (9.0) | 0.427 (10.8) | 0.247 (6.3) | Green | 375 |
| ALNS-2-14 | #2 AWG | 2-6 AWG | 1/4 | 0.281 (7.1) | 0.990 (25.1) | 0.970 (24.6) | 2.240 (56.9) | 0.700 (17.8) | 0.321 (8.1) | 0.525 (13.3) | 0.307 (7.8) | Pink | 348 |
| ALNS-2-516 | #2 AWG | 2-6 AWG | 5/16 | 0.343 (8.7) | 1.058 (26.9) | 0.970 (24.6) | 2.240 (56.9) | 0.700 (17.8) | 0.442 (11.2) | 0.525 (13.3) | 0.307 (7.8) | Pink | 348 |
| ALNS-2-38 | #2 AWG | 2-6 AWG | 3/8 | 0.406 (10.3) | 0.940 (23.9) | 0.970 (24.6) | 2.240 (56.9) | 0.700 (17.8) | 0.414 (10.5) | 0.525 (13.3) | 0.307 (7.8) | Pink | 348 |
| ALNS-1-14 | #1 AWG | 1-2 AWG | 1/4 | 0.281 (7.1) | 0.996 (25.3) | 0.970 (24.6) | 2.290 (58.2) | 0.748 (19.0) | 0.321 (8.1) | 0.544 (13.8) | 0.358 (9.1) | Gold | 471 |
| ALNS-1-516 | #1 AWG | 1-2 AWG | 5/16 | 0.343 (8.7) | 0.937 (23.8) | 0.970 (24.6) | 2.175 (55.2) | 0.748 (19.0) | 0.353 (9.0) | 0.544 (13.8) | 0.358 (9.1) | Gold | 471 |
| ALNS-1-38 | #1 AWG | 1-2 AWG | 3/8 | 0.406 (10.3) | 0.939 (23.9) | 0.970 (24.6) | 2.290 (58.2) | 0.748 (19.0) | 0.414 (10.5) | 0.544 (13.8) | 0.358 (9.1) | Gold | 471 |
| ALNS-1/0-516 | 1/0 AWG | 1/0-1 AWG | 5/16 | 0.343 (8.7) | 0.937 (23.8) | 1.070 (27.2) | 2.301 (58.4) | 0.819 (20.8) | 0.353 (9.0) | 0.599 (15.2) | 0.385 (9.8) | Tan | 296 |
| ALNS-1/0-38 | 1/0 AWG | 1/0-1 AWG | 3/8 | 0.406 (10.3) | 0.937 (23.8) | 1.070 (27.2) | 2.460 (62.5) | 0.819 (20.8) | 0.414 (10.5) | 0.599 (15.2) | 0.385 (9.8) | Tan | 296 |
| ALNS-1/0-12 | 1/0 AWG | 1/0-1 AWG | 1/2 | 0.562 (14.3) | 1.292 (32.8) | 1.070 (27.2) | 2.820 (71.6) | 0.819 (20.8) | 0.546 (13.9) | 0.599 (15.2) | 0.385 (9.8) | Tan | 296 |
| ALNS-2/0-38 | 2/0 AWG | 2/0-1 AWG | 3/8 | 0.406 (10.3) | 0.925 (23.5) | 1.355 (34.4) | 2.910 (73.9) | 0.921 (23.4) | 0.414 (10.5) | 0.674 (17.1) | 0.432 (11.0) | Olive | 297 |
| ALNS-2/0-12 | 2/0 AWG | 2/0-1 AWG | 1/2 | 0.562 (14.3) | 1.283 (32.6) | 1.355 (34.4) | 3.285 (83.4) | 0.921 (23.4) | 0.546 (13.9) | 0.674 (17.1) | 0.432 (11.0) | Olive | 297 |
| ALNS-3/0-38 | 3/0 AWG | 3/0-1 AWG | 3/8 | 0.406 (10.3) | 0.900 (22.9) | 1.355 (34.4) | 2.950 (74.9) | 1.044 (26.5) | 0.414 (10.5) | 0.761 (19.3) | 0.495 (12.6) | Ruby | 467 |
| ALNS-3/0-12 | 3/0 AWG | 3/0-1 AWG | 1/2 | 0.562 (14.3) | 1.280 (32.5) | 1.355 (34.4) | 3.310 (84.1) | 1.044 (26.5) | 0.546 (13.9) | 0.761 (19.3) | 0.495 (12.6) | Ruby | 467 |
| ALNS-4/0-38 | 4/0 AWG | 4/0-1 AWG | 3/8 | 0.406 (10.3) | 0.935 (23.7) | 1.535 (39.0) | 3.090 (78.5) | 1.170 (29.7) | 0.414 (10.5) | 0.854 (21.7) | 0.553 (14.0) | White | 298 |
| ALNS-4/0-12 | 4/0 AWG | 4/0-1 AWG | 1/2 | 0.562 (14.3) | 1.145 (29.1) | 1.535 (39.0) | 4.177 (106.1) | 1.170 (29.7) | 0.546 (13.9) | 0.854 (21.7) | 0.553 (14.0) | White | 298 |

Tested to UL 486A/B, UL File E6207

For Tool and Die Information Refer to Tooling Information Page Series: ALNS, ALND, ALNN, ASN

* When installed with specified dieless tools

SureCrimp Aluminum Compression Lugs

Long Barrel - Standard Tang - Dual Rated, Conductor Range: 1000kcmil - 250kcmil

RoHS
Compliant

UL
LISTED
453G

SA
LR-29601

TYPE ALNS

Features

- Manufactured from high strength aluminum alloy
- Electro-Tin plated
- Chamfered entry
- Color coded end cap
- Ink marked
- Pre-filled with De-Ox oxide inhibiting compound
- Range taking
- Suitable for use in circuits rated 35KV or less, proper high voltage spacing and insulation techniques must be used
- Dual rated AL9CU to 90° C/194° F

Benefits

- Offers maximum conductivity and excellent crimping characteristics
- Provides low contact resistance
- For easy conductor insertion
- Identifies the proper conductor size
- For easy identification and proper location of crimps
- Prevents oxides from forming & promotes connector longevity
- Permits inventories to be kept to a minimum
- Application versatility
- For use with aluminum or copper conductor

A

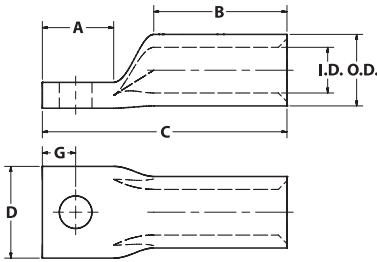

| Catalog Number | Wire Size | Expanded Wire Size* | Bolt Size | Stud Hole Dia. | Dimensions - in. (mm) | | | | | O.D. | I.D. | Die Color Code | Die Index |
|-----------------|--------------|------------------------------------------|-----------|----------------|-----------------------|--------------|---------------|--------------|--------------|--------------|--------------|----------------|-----------|
| | | | | | A | B | C | D | G | | | | |
| ALNS-250-38 | 250kcmil | 250kcmil - 1/0 AWG | 3/8 | 0.406 (10.3) | 0.875 (22.2) | 1.535 (39.0) | 3.200 (81.3) | 1.264 (32.1) | 0.414 (10.5) | 0.924 (23.5) | 0.595 (15.1) | Red | 324 |
| ALNS-250-12 | 250kcmil | 250kcmil - 1/0 AWG | 1/2 | 0.562 (14.3) | 0.875 (22.2) | 1.535 (39.0) | 3.316 (84.2) | 1.264 (32.1) | 0.546 (13.9) | 0.924 (23.5) | 0.595 (15.1) | Red | 324 |
| ALNS-300-38 | 300kcmil | 300kcmil - 2/0 AWG | 3/8 | 0.406 (10.3) | 0.905 (23.0) | 1.535 (39.0) | 3.296 (83.7) | 1.381 (35.1) | 0.414 (10.5) | 1.010 (25.7) | 0.650 (16.5) | Blue | 470 |
| ALNS-300-12 | 300kcmil | 300kcmil - 2/0 AWG | 1/2 | 0.562 (14.3) | 1.295 (32.9) | 1.535 (39.0) | 3.690 (93.7) | 1.381 (35.1) | 0.546 (13.9) | 1.010 (25.7) | 0.650 (16.5) | Blue | 470 |
| ALNS-350-12 | 350kcmil | 350kcmil - 3/0 AWG | 1/2 | 0.562 (14.3) | 1.280 (32.5) | 2.353 (59.8) | 4.310 (109.5) | 1.516 (38.5) | 0.546 (13.9) | 1.105 (28.1) | 0.720 (18.3) | Brown | 299 |
| ALNS-400-12 | 400kcmil | 400kcmil - 4/0 AWG | 1/2 | 0.562 (14.3) | 1.302 (33.1) | 2.303 (58.5) | 4.250 (108.0) | 1.623 (41.2) | 0.546 (13.9) | 1.188 (30.2) | 0.762 (19.4) | Green | 472 |
| ALNS-400-58 | 400kcmil | 400kcmil - 4/0 AWG | 5/8 | 0.656 (16.7) | 1.485 (37.7) | 2.303 (58.5) | 4.420 (112.3) | 1.623 (41.2) | 0.671 (17.0) | 1.188 (30.2) | 0.762 (19.4) | Green | 472 |
| ALNS-500-12 | 500kcmil | 500kcmil - 4/0 AWG | 1/2 | 0.562 (14.3) | 1.303 (33.1) | 2.565 (65.2) | 4.745 (120.5) | 1.802 (45.8) | 0.546 (13.9) | 1.315 (33.4) | 0.854 (21.7) | Pink | 300 |
| ALNS-500-58 | 500kcmil | 500kcmil - 4/0 AWG | 5/8 | 0.656 (16.7) | 1.500 (38.1) | 2.565 (65.2) | 4.930 (125.2) | 1.802 (45.8) | 0.671 (17.0) | 1.315 (33.4) | 0.854 (21.7) | Pink | 300 |
| ALNS-600-12 | 600kcmil | 600kcmil - 250kcmil | 1/2 | 0.562 (14.3) | 1.372 (34.8) | 2.685 (68.2) | 5.250 (133.4) | 1.965 (49.9) | 0.671 (17.0) | 1.440 (36.6) | 0.920 (23.4) | Black | 473 |
| ALNS-600-58 | 600kcmil | 600kcmil - 250kcmil | 5/8 | 0.656 (16.7) | 1.528 (38.8) | 2.685 (68.2) | 5.350 (135.9) | 1.965 (49.9) | 0.671 (17.0) | 1.440 (36.6) | 0.920 (23.4) | Black | 473 |
| ALNS-700/750-12 | 700/750kcmil | 750kcmil-500kcmil, 900kcmil compact Al** | 1/2 | 0.562 (14.3) | 1.380 (35.1) | 2.964 (75.3) | 5.492 (139.5) | 2.048 (52.0) | 0.546 (13.9) | 1.460 (37.1) | 1.030 (26.2) | Yellow | 936 |
| ALNS-1000-12 | 1000kcmil | 1000kcmil-750kcmil | 1/2 | 0.562 (14.3) | 1.461 (37.1) | 2.996 (76.1) | 6.100 (154.9) | 2.514 (63.9) | 0.811 (20.6) | 1.840 (46.7) | 1.180 (30.0) | Brown | P302 |
| ALNS-1000-58 | 1000kcmil | 1000kcmil-750kcmil | 5/8 | 0.656 (16.7) | 1.800 (45.7) | 2.996 (76.1) | 6.350 (161.3) | 2.514 (63.9) | 0.671 (17.0) | 1.840 (46.7) | 1.180 (30.0) | Brown | P302 |

Tested to UL 486A/B, UL File E6207 For Tool and Die Information Refer to Tooling Information Page Series: ALNS, ALND, ALNN, ASN

* When installed with specified dieless tools ** UL Listed 900kcmil compact Al

SureCrimp Aluminum Compression Lugs

Long Barrel - Standard Tang - Dual Rated

Conductor Range: 4/0 - #8

RoHS
Compliant

UL
LISTED
453G

SA
LR-29601

A TYPE ALND

Features

- Manufactured from high strength aluminum alloy
- Electro-Tin plated
- Chamfered entry
- Color coded end cap
- Ink marked
- Two bolt hole pattern
- Pre-filled with De-Ox oxide inhibiting compound
- Range taking
- Suitable for use in circuits rated 35KV or less, proper high voltage spacing and insulation techniques must be used
- Dual rated AL9CU to 90° C/194° F

Benefits

- Offers maximum conductivity and excellent crimping characteristics
- Provides low contact resistance
- For easy conductor insertion
- Identifies the proper compression die
- For easy identification and proper location of crimps
- Provides maximum surface contact, secure attachment, and stabilization
- Prevents oxides from forming & promotes connector longevity
- Permits inventories to be kept to a minimum
- Application versatility
- For use with aluminum or copper conductor

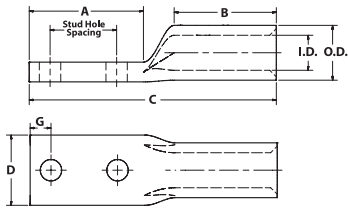

| Catalog Number | Wire Size | Expanded Wire Size* | Bolt Size | Stud Hole Dia. | Stud Hole Spacing | Dimensions - in. (mm) | | | | | O.D. | I.D. | Die Color Code | Die Index |
|-----------------|-----------|---------------------|-----------|----------------|-------------------|-----------------------|--------------|---------------|--------------|--------------|--------------|--------------|----------------|-----------|
| | | | | | | A | B | C | D | G | | | | |
| ALND-8-10-1 | #8 AWG | - | #10 | 0.219 (5.6) | 1.000 (25.4) | 1.750 (44.5) | 0.602 (15.3) | 2.560 (65.0) | 0.388 (9.9) | 0.259 (6.6) | 0.300 (7.6) | 0.155 (3.9) | Blue | 374 |
| ALND-6-14-1 | #6 AWG | - | 1/4 | 0.281 (7.1) | 1.000 (25.4) | 1.687 (42.9) | 0.602 (15.3) | 2.650 (67.3) | 0.449 (11.4) | 0.321 (8.2) | 0.338 (8.6) | 0.194 (4.9) | Gray | 346 |
| ALND-4-14-1 | #4 AWG | 4-6 AWG | 1/4 | 0.281 (7.1) | 1.000 (25.4) | 1.636 (41.6) | 0.920 (23.4) | 2.930 (74.4) | 0.568 (14.4) | 0.321 (8.2) | 0.427 (10.8) | 0.247 (6.3) | Green | 375 |
| ALND-2-14-1 | #2 AWG | 2-6 AWG | 1/4 | 0.281 (7.1) | 1.000 (25.4) | 1.635 (41.5) | 0.970 (24.6) | 3.035 (77.1) | 0.700 (17.8) | 0.321 (8.2) | 0.525 (13.3) | 0.307 (7.8) | Pink | 348 |
| ALND-2-38-1 | #2 AWG | 2-6 AWG | 3/8 | 0.406 (10.3) | 1.000 (25.4) | 1.994 (50.6) | 0.970 (24.6) | 3.290 (83.6) | 0.700 (17.8) | 0.414 (10.5) | 0.525 (13.3) | 0.307 (7.8) | Pink | 348 |
| ALND-2-38-134 | #2 AWG | 2-6 AWG | 3/8 | 0.406 (10.3) | 1.750 (44.5) | 2.676 (68.0) | 0.970 (24.6) | 3.985 (101.2) | 0.700 (17.8) | 0.414 (10.5) | 0.525 (13.3) | 0.307 (7.8) | Pink | 348 |
| ALND-1-14-1 | #1 AWG | 1-2 AWG | 1/4 | 0.281 (7.1) | 1.000 (25.4) | 1.633 (41.5) | 0.970 (24.6) | 3.086 (78.4) | 0.748 (18.9) | 0.321 (8.2) | 0.544 (13.8) | 0.358 (9.1) | Gold | 471 |
| ALND-1-38-1 | #1 AWG | 1-2 AWG | 3/8 | 0.406 (10.3) | 1.000 (25.4) | 1.992 (50.6) | 0.970 (24.6) | 3.345 (85.0) | 0.748 (18.9) | 0.414 (10.5) | 0.544 (13.8) | 0.358 (9.1) | Gold | 471 |
| ALND-1-38-134 | #1 AWG | 1-2 AWG | 3/8 | 0.406 (10.3) | 1.750 (44.5) | 2.694 (68.43) | 0.970 (24.6) | 4.035 (102.5) | 0.748 (18.9) | 0.414 (10.5) | 0.544 (13.8) | 0.358 (9.1) | Gold | 471 |
| ALND-1/0-14-1 | 1/0 AWG | 1/0-1 AWG | 1/4 | 0.281 (7.1) | 1.000 (25.4) | 1.586 (40.3) | 1.070 (27.2) | 3.230 (82.0) | 0.819 (20.8) | 0.321 (8.2) | 0.599 (15.2) | 0.385 (9.8) | Tan | 296 |
| ALND-1/0-38-1 | 1/0 AWG | 1/0-1 AWG | 3/8 | 0.406 (10.3) | 1.000 (25.4) | 1.987 (50.5) | 1.070 (27.2) | 3.500 (88.9) | 0.819 (20.8) | 0.414 (10.5) | 0.599 (15.2) | 0.385 (9.8) | Tan | 296 |
| ALND-1/0-38-134 | 1/0 AWG | 1/0-1 AWG | 3/8 | 0.406 (10.3) | 1.750 (44.5) | 2.646 (67.2) | 1.070 (27.2) | 4.185 (106.3) | 0.819 (20.8) | 0.414 (10.5) | 0.599 (15.2) | 0.385 (9.8) | Tan | 296 |
| ALND-1/0-12-1 | 1/0 AWG | 1/0-1 AWG | 1/2 | 0.562 (14.3) | 1.000 (25.4) | 2.181 (55.4) | 1.070 (27.2) | 3.700 (94.0) | 0.819 (20.8) | 0.546 (13.9) | 0.599 (15.2) | 0.385 (9.8) | Tan | 296 |
| ALND-1/0-12-134 | 1/0 AWG | 1/0-1 AWG | 1/2 | 0.562 (14.3) | 1.750 (44.5) | 3.031 (77.0) | 1.070 (27.2) | 4.560 (115.8) | 0.819 (20.8) | 0.546 (13.9) | 0.599 (15.2) | 0.385 (9.8) | Tan | 296 |
| ALND-2/0-38-1 | 2/0 AWG | 2/0-1 AWG | 3/8 | 0.406 (10.3) | 1.000 (25.4) | 1.975 (50.2) | 1.355 (34.4) | 3.940 (100.1) | 0.921 (23.4) | 0.414 (10.5) | 0.674 (17.1) | 0.432 (11.0) | Olive | 297 |
| ALND-2/0-38-134 | 2/0 AWG | 2/0-1 AWG | 3/8 | 0.406 (10.3) | 1.750 (44.5) | 2.660 (67.6) | 1.355 (34.4) | 4.633 (117.7) | 0.921 (23.4) | 0.414 (10.5) | 0.674 (17.1) | 0.432 (11.0) | Olive | 297 |
| ALND-2/0-12-1 | 2/0 AWG | 2/0-1 AWG | 1/2 | 0.562 (14.3) | 1.000 (25.4) | 2.166 (55.0) | 1.355 (34.4) | 4.137 (105.1) | 0.921 (23.4) | 0.546 (13.9) | 0.674 (17.1) | 0.432 (11.0) | Olive | 297 |
| ALND-2/0-12-134 | 2/0 AWG | 2/0-1 AWG | 1/2 | 0.562 (14.3) | 1.750 (44.5) | 3.035 (77.1) | 1.355 (34.4) | 5.025 (127.6) | 0.921 (23.4) | 0.546 (13.9) | 0.674 (17.1) | 0.432 (11.0) | Olive | 297 |
| ALND-3/0-38-1 | 3/0 AWG | 3/0-1 AWG | 3/8 | 0.406 (10.3) | 1.000 (25.4) | 1.981 (50.3) | 1.355 (34.4) | 4.020 (102.1) | 1.044 (26.5) | 0.414 (10.5) | 0.761 (19.3) | 0.495 (12.6) | Ruby | 467 |
| ALND-3/0-38-134 | 3/0 AWG | 3/0-1 AWG | 3/8 | 0.406 (10.3) | 1.750 (44.5) | 2.671 (67.8) | 1.355 (34.4) | 4.695 (119.3) | 1.044 (26.5) | 0.414 (10.5) | 0.761 (19.3) | 0.495 (12.6) | Ruby | 467 |
| ALND-3/0-12-1 | 3/0 AWG | 3/0-1 AWG | 1/2 | 0.562 (14.3) | 1.000 (25.4) | 2.190 (55.6) | 1.355 (34.4) | 4.200 (106.7) | 1.044 (26.5) | 0.546 (13.9) | 0.761 (19.3) | 0.495 (12.6) | Ruby | 467 |
| ALND-3/0-12-134 | 3/0 AWG | 3/0-1 AWG | 1/2 | 0.562 (14.3) | 1.750 (44.5) | 3.032 (77.0) | 1.355 (34.4) | 5.260 (133.6) | 1.044 (26.5) | 0.546 (13.9) | 0.761 (19.3) | 0.495 (12.6) | Ruby | 467 |
| ALND-4/0-38-1 | 4/0 AWG | 4/0-1 AWG | 3/8 | 0.406 (10.3) | 1.000 (25.4) | 2.005 (50.9) | 1.535 (39.0) | 4.120 (104.7) | 1.170 (29.7) | 0.414 (10.5) | 0.854 (21.7) | 0.553 (14.0) | White | 298 |
| ALND-4/0-38-134 | 4/0 AWG | 4/0-1 AWG | 3/8 | 0.406 (10.3) | 1.750 (44.5) | 2.668 (67.8) | 1.535 (39.0) | 4.800 (121.9) | 1.170 (29.7) | 0.414 (10.5) | 0.854 (21.7) | 0.553 (14.0) | White | 298 |
| ALND-4/0-12-1 | 4/0 AWG | 4/0-1 AWG | 1/2 | 0.562 (14.3) | 1.000 (25.4) | 2.177 (55.3) | 1.535 (39.0) | 4.300 (109.2) | 1.170 (29.7) | 0.546 (13.9) | 0.854 (21.7) | 0.553 (14.0) | White | 298 |
| ALND-4/0-12-134 | 4/0 AWG | 4/0-1 AWG | 1/2 | 0.562 (14.3) | 1.750 (44.5) | 3.044 (77.3) | 1.535 (39.0) | 5.195 (132.0) | 1.170 (29.7) | 0.546 (13.9) | 0.854 (21.7) | 0.553 (14.0) | White | 298 |

Tested to UL 486A/B, UL File E6207

For Tool and Die Information Refer to Tooling Information Page Series: ALNS, ALND, ALNN, ASN * When installed with specified dieless tools

SureCrimp Aluminum Compression Lugs

Long Barrel - Standard Tang - Dual Rated

Conductor Range: 500kcmil - 250kcmil



TYPE ALND

Features

- Manufactured from high strength aluminum alloy
- Electro-Tin plated
- Chamfered entry
- Color coded end cap
- Ink marked
- Two bolt hole pattern
- Pre-filled with De-Ox oxide inhibiting compound
- Range taking
- Suitable for use in circuits rated 35KV or less, proper high voltage spacing and insulation techniques must be used
- Dual rated AL9CU to 90° C/194° F

Benefits

- Offers maximum conductivity and excellent crimping characteristics
- Provides low contact resistance
- For easy conductor insertion
- Identifies the proper compression die
- For easy identification and proper location of crimps
- Provides maximum surface contact, secure attachment, and stabilization
- Prevents oxides from forming & promotes connector longevity
- Permits inventories to be kept to a minimum
- Application versatility
- For use with aluminum or copper conductor

A

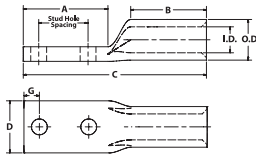

| Catalog Number | Wire Size | Expanded Wire Size* | Bolt Size | Stud Hole Dia. | Stud Hole Spacing | Dimensions - in. (mm) | | | | | O.D. | I.D. | Die Color Code | Die Index |
|-----------------|-----------|---------------------|-----------|----------------|-------------------|-----------------------|--------------|----------------|--------------|--------------|--------------|--------------|----------------|-----------|
| | | | | | | A | B | C | D | G | | | | |
| ALND-250-38-1 | 250kcmil | 250kcmil - 1/0 AWG | 3/8 | 0.406 (10.3) | 1.000 (25.4) | 2.000 (50.8) | 1.535 (39.0) | 4.324 (109.8) | 1.264 (32.1) | 0.414 (10.5) | 0.924 (23.5) | 0.595 (15.1) | Red | 324 |
| ALND-250-38-134 | 250kcmil | 250kcmil - 1/0 AWG | 3/8 | 0.406 (10.3) | 1.750 (44.5) | 2.600 (66.0) | 1.535 (39.0) | 5.000 (127.0) | 1.264 (32.1) | 0.414 (10.5) | 0.924 (23.5) | 0.595 (15.1) | Red | 324 |
| ALND-250-12-1 | 250kcmil | 250kcmil - 1/0 AWG | 1/2 | 0.562 (14.3) | 1.000 (25.4) | 2.190 (55.6) | 1.535 (39.0) | 4.500 (114.3) | 1.264 (32.1) | 0.546 (13.9) | 0.924 (23.5) | 0.595 (15.1) | Red | 324 |
| ALND-250-12-134 | 250kcmil | 250kcmil - 1/0 AWG | 1/2 | 0.562 (14.3) | 1.750 (44.5) | 3.042 (77.3) | 1.535 (39.0) | 5.557 (141.1) | 1.264 (32.1) | 0.546 (13.9) | 0.924 (23.5) | 0.595 (15.1) | Red | 324 |
| ALND-300-38-1 | 300kcmil | 300kcmil - 2/0 AWG | 3/8 | 0.406 (10.3) | 1.000 (25.4) | 1.970 (50.0) | 1.535 (39.0) | 4.345 (110.4) | 1.381 (35.1) | 0.414 (10.5) | 1.010 (25.7) | 0.650 (16.5) | Blue | 470 |
| ALND-300-38-134 | 300kcmil | 300kcmil - 2/0 AWG | 3/8 | 0.406 (10.3) | 1.750 (44.5) | 2.643 (67.1) | 1.535 (39.0) | 5.023 (127.6) | 1.381 (35.1) | 0.414 (10.5) | 1.010 (25.7) | 0.650 (16.5) | Blue | 470 |
| ALND-300-12-1 | 300kcmil | 300kcmil - 2/0 AWG | 1/2 | 0.562 (14.3) | 1.000 (25.4) | 2.143 (54.4) | 1.535 (39.0) | 4.519 (114.8) | 1.381 (35.1) | 0.546 (13.9) | 1.010 (25.7) | 0.650 (16.5) | Blue | 470 |
| ALND-300-12-134 | 300kcmil | 300kcmil - 2/0 AWG | 1/2 | 0.562 (14.3) | 1.750 (44.5) | 3.000 (76.2) | 1.535 (39.0) | 5.122 (130.1) | 1.381 (35.1) | 0.546 (13.9) | 1.010 (25.7) | 0.650 (16.5) | Blue | 470 |
| ALND-350-38-1 | 350kcmil | 350kcmil - 3/0 AWG | 3/8 | 0.406 (10.3) | 1.000 (25.4) | 1.982 (50.3) | 2.353 (59.8) | 5.310 (134.9) | 1.516 (38.5) | 0.414 (10.5) | 1.105 (28.1) | 0.720 (18.3) | Brown | 299 |
| ALND-350-38-134 | 350kcmil | 350kcmil - 3/0 AWG | 3/8 | 0.406 (10.3) | 1.750 (44.5) | 2.625 (66.7) | 2.353 (59.8) | 5.661 (143.79) | 1.516 (38.5) | 0.414 (10.5) | 1.105 (28.1) | 0.720 (18.3) | Brown | 299 |
| ALND-350-12-1 | 350kcmil | 350kcmil - 3/0 AWG | 1/2 | 0.562 (14.3) | 1.000 (25.4) | 2.169 (55.1) | 2.353 (59.8) | 5.480 (139.2) | 1.516 (38.5) | 0.546 (13.9) | 1.105 (28.1) | 0.720 (18.3) | Brown | 299 |
| ALND-350-12-134 | 350kcmil | 350kcmil - 3/0 AWG | 1/2 | 0.562 (14.3) | 1.750 (44.5) | 3.025 (76.8) | 2.353 (59.8) | 6.065 (154.1) | 1.516 (38.5) | 0.546 (13.9) | 1.105 (28.1) | 0.720 (18.3) | Brown | 299 |
| ALND-400-38-1 | 400kcmil | 400kcmil - 4/0 AWG | 3/8 | 0.406 (10.3) | 1.000 (25.4) | 1.993 (50.6) | 2.303 (58.5) | 4.920 (125.0) | 1.623 (41.2) | 0.414 (10.5) | 1.188 (30.2) | 0.762 (19.4) | Green | 472 |
| ALND-400-38-134 | 400kcmil | 400kcmil - 4/0 AWG | 3/8 | 0.406 (10.3) | 1.750 (44.5) | 2.709 (68.8) | 2.303 (58.5) | 5.635 (143.1) | 1.623 (41.2) | 0.468 (11.9) | 1.188 (30.2) | 0.762 (19.4) | Green | 472 |
| ALND-400-12-1 | 400kcmil | 400kcmil - 4/0 AWG | 1/2 | 0.562 (14.3) | 1.000 (25.4) | 2.167 (55.0) | 2.303 (58.5) | 5.091 (129.3) | 1.623 (41.2) | 0.546 (13.9) | 1.188 (30.2) | 0.762 (19.4) | Green | 472 |
| ALND-400-12-134 | 400kcmil | 400kcmil - 4/0 AWG | 1/2 | 0.562 (14.3) | 1.750 (44.5) | 3.055 (77.6) | 2.303 (58.5) | 5.990 (152.1) | 1.623 (41.2) | 0.546 (13.9) | 1.188 (30.2) | 0.762 (19.4) | Green | 472 |
| ALND-500-38-1 | 500kcmil | 500kcmil - 4/0 AWG | 3/8 | 0.406 (10.3) | 1.000 (25.4) | 2.005 (50.9) | 2.565 (65.2) | 5.410 (137.4) | 1.802 (45.8) | 0.414 (10.5) | 1.315 (33.4) | 0.854 (21.7) | Pink | 300 |
| ALND-500-38-134 | 500kcmil | 500kcmil - 4/0 AWG | 3/8 | 0.406 (10.3) | 1.750 (44.5) | 2.627 (66.7) | 2.565 (65.2) | 6.075 (154.3) | 1.802 (45.8) | 0.414 (10.5) | 1.315 (33.4) | 0.854 (21.7) | Pink | 300 |
| ALND-500-12-1 | 500kcmil | 500kcmil - 4/0 AWG | 1/2 | 0.562 (14.3) | 1.000 (25.4) | 2.171 (55.1) | 2.565 (65.2) | 5.590 (142.0) | 1.802 (45.8) | 0.546 (13.9) | 1.315 (33.4) | 0.854 (21.7) | Pink | 300 |
| ALND-500-12-134 | 500kcmil | 500kcmil - 4/0 AWG | 1/2 | 0.562 (14.3) | 1.750 (44.5) | 3.020 (76.7) | 2.565 (65.2) | 6.450 (163.8) | 1.802 (45.8) | 0.546 (13.9) | 1.315 (33.4) | 0.854 (21.7) | Pink | 300 |

Tested to UL 486A/B, UL File E6207

For Tool and Die Information Refer to Tooling Information Page Series: ALNS, ALND, ALNN, ASN * When installed with specified dieless tools

SureCrimp Aluminum Compression Lugs

Long Barrel - Standard Tang - Dual Rated

Conductor Range: 1000kcmil - 600kcmil



A TYPE ALND

Features

- Manufactured from high strength aluminum alloy
- Electro-Tin plated
- Chamfered entry
- Color coded end cap
- Ink marked
- Two bolt hole pattern
- Pre-filled with De-Ox oxide inhibiting compound
- Range taking
- Suitable for use in circuits rated 35KV or less, proper high voltage spacing and insulation techniques must be used
- Dual rated AL9CU to 90° C/194° F

Benefits

- Offers maximum conductivity and excellent crimping characteristics
- Provides low contact resistance
- For easy conductor insertion
- Identifies the proper compression die
- For easy identification and proper location of crimps
- Provides maximum surface contact, secure attachment, and stabilization
- Prevents oxides from forming & promotes connector longevity
- Permits inventories to be kept to a minimum
- Application versatility
- For use with aluminum or copper conductor

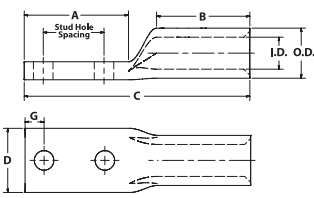

| Catalog Number | Wire Size | Expanded Wire Size* | Bolt Size | Stud Hole Dia. | Stud Hole Spacing | Dimensions - in. (mm) | | | | | O.D. | I.D. | Die Color Code | Die Index |
|---------------------|--------------|------------------------------------------|-----------|----------------|-------------------|-----------------------|--------------|---------------|--------------|--------------|--------------|--------------|----------------|-----------|
| | | | | | | A | B | C | D | G | | | | |
| ALND-600-38-1 | 600kcmil | 600kcmil-250kcmil | 3/8 | 0.406 (10.3) | 1.000 (25.4) | 2.128 (54.1) | 2.685 (68.2) | 5.975 (151.8) | 1.965 (49.9) | 0.593 (15.1) | 1.440 (36.6) | 0.920 (23.4) | Black | 473 |
| ALND-600-38-134 | 600kcmil | 600kcmil-250kcmil | 3/8 | 0.406 (10.3) | 1.750 (44.5) | 2.796 (71.0) | 2.685 (68.2) | 6.660 (169.2) | 1.965 (49.9) | 0.593 (15.1) | 1.440 (36.6) | 0.920 (23.4) | Black | 473 |
| ALND-600-12-1 | 600kcmil | 600kcmil-250kcmil | 1/2 | 0.562 (14.3) | 1.000 (25.4) | 2.262 (57.5) | 2.685 (68.2) | 6.130 (155.7) | 1.965 (49.9) | 0.671 (17.0) | 1.440 (36.6) | 0.920 (23.4) | Black | 473 |
| ALND-600-12-134 | 600kcmil | 600kcmil-250kcmil | 1/2 | 0.562 (14.3) | 1.750 (44.5) | 3.150 (80.0) | 2.685 (68.2) | 6.973 (177.1) | 1.965 (49.9) | 0.546 (13.9) | 1.440 (36.6) | 0.920 (23.4) | Black | 473 |
| ALND-700/750-38-1 | 700/750kcmil | 750kcmil-500kcmil, 900kcmil compact AI** | 3/8 | 0.406 (10.3) | 1.000 (25.4) | 2.121 (53.9) | 2.964 (75.3) | 6.220 (158.0) | 2.048 (52.0) | 0.623 (15.8) | 1.460 (37.1) | 1.030 (26.2) | Yellow | 936 |
| ALND-700/750-38-134 | 700/750kcmil | 750kcmil-500kcmil, 900kcmil compact AI** | 3/8 | 0.406 (10.3) | 1.750 (44.5) | 2.812 (71.4) | 2.964 (75.3) | 6.900 (175.3) | 2.048 (52.0) | 0.623 (15.8) | 1.460 (37.1) | 1.030 (26.2) | Yellow | 936 |
| ALND-700/750-12-1 | 700/750kcmil | 750kcmil-500kcmil, 900kcmil compact AI** | 1/2 | 0.562 (14.3) | 1.000 (25.4) | 2.298 (58.4) | 2.964 (75.3) | 6.400 (162.6) | 2.048 (52.0) | 0.701 (17.8) | 1.460 (37.1) | 1.030 (26.2) | Yellow | 936 |
| ALND-700/750-12-134 | 700/750kcmil | 750kcmil-500kcmil, 900kcmil compact AI** | 1/2 | 0.562 (14.3) | 1.750 (44.5) | 3.162 (80.3) | 2.964 (75.3) | 7.062 (179.4) | 2.048 (52.0) | 0.546 (13.9) | 1.460 (37.1) | 1.030 (26.2) | Yellow | 936 |
| ALND-1000-38-1 | 1000kcmil | 1000kcmil-750kcmil | 3/8 | 0.406 (10.3) | 1.000 (25.4) | 2.249 (57.1) | 2.996 (76.1) | 6.840 (173.8) | 2.514 (63.9) | 0.733 (18.6) | 1.840 (46.7) | 1.180 (30.0) | Brown | P302 |
| ALND-1000-38-134 | 1000kcmil | 1000kcmil-750kcmil | 3/8 | 0.406 (10.3) | 1.750 (44.5) | 2.947 (74.9) | 2.996 (76.1) | 7.530 (191.3) | 2.514 (63.9) | 0.733 (18.6) | 1.840 (46.7) | 1.180 (30.0) | Brown | P302 |
| ALND-1000-12-1 | 1000kcmil | 1000kcmil-750kcmil | 1/2 | 0.562 (14.3) | 1.000 (25.4) | 2.125 (54.0) | 2.996 (76.1) | 6.806 (172.9) | 2.514 (63.9) | 0.811 (20.6) | 1.840 (46.7) | 1.180 (30.0) | Brown | P302 |
| ALND-1000-12-134 | 1000kcmil | 1000kcmil-750kcmil | 1/2 | 0.562 (14.3) | 1.750 (44.5) | 3.231 (82.1) | 2.996 (76.1) | 7.795 (198.0) | 2.514 (63.9) | 0.546 (13.9) | 1.840 (46.7) | 1.180 (30.0) | Brown | P302 |

Tested to UL 486A/B, UL File E6207

For Tool and Die Information Refer to Tooling Information Page Series: ALNS, ALND, ALNN, ASN * When installed with specified dieless tools

** UL Listed 900kcmil compact AI

SureCrimp Aluminum Compression Lugs

Narrow Tang, 1 Hole, w/o Sight Hole

Conductor Range: 1000kcmil - #4



TYPE ALNN

Features

- Manufactured from high strength aluminum alloy
- Electro-Tin plated
- Chamfered entry
- Color coded end cap
- Ink marked
- Pre-filled with De-Ox oxide inhibiting compound
- Range taking
- Narrow Tang
- Suitable for use in circuits rated 35KV or less, proper high voltage spacing and insulation techniques must be used
- Dual rated AL9CU to 90° C/194° F

Benefits

- Offers maximum conductivity and excellent crimping characteristics
- Provides low contact resistance
- For easy conductor insertion
- Identifies the proper compression die
- For easy identification and proper location of crimps
- Prevents oxides from forming
- Permits inventories to be kept to a minimum
- Side by side mounting
- Application versatility
- For use with copper or aluminum conductor

A

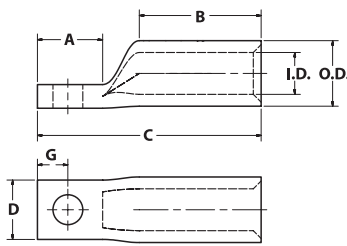

| Catalog Number | Wire Size | Expanded Wire Size* | Bolt Size | Stud Hole Dia. | Dimensions - in. (mm) | | | | | O.D. | I.D. | Die Color Code | Die Index |
|-----------------|----------------|------------------------------------------|-----------|----------------|-----------------------|--------------|---------------|--------------|--------------|--------------|--------------|----------------|-----------|
| | | | | | A | B | C | D | G | | | | |
| ALNN-4-14 | #4 AWG | 4-6 AWG | 1/4 | 0.281 (7.1) | 0.875 (22.2) | 0.920 (23.4) | 2.029 (51.5) | 0.412 (10.5) | 0.321 (8.2) | 0.427 (10.8) | 0.247 (6.3) | Green | 375 |
| ALNN-2-14 | #2 AWG | 2-6 AWG | 1/4 | 0.281 (7.1) | 0.875 (22.2) | 0.970 (24.6) | 2.131 (54.1) | 0.495 (12.6) | 0.321 (8.2) | 0.525 (13.3) | 0.307 (7.8) | Pink | 348 |
| ALNN-1-14 | #1 AWG | 1-2 AWG | 1/4 | 0.281 (7.1) | 1.687 (42.8) | 0.970 (24.6) | 2.175 (55.2) | 0.514 (13.1) | 0.321 (8.2) | 0.544 (13.8) | 0.358 (9.1) | Gold | 471 |
| ALNN-1-516 | #1 AWG | 1-2 AWG | 5/16 | 0.343 (8.7) | 0.875 (22.2) | 0.970 (24.6) | 2.175 (55.2) | 0.514 (13.1) | 0.353 (9.0) | 0.544 (13.8) | 0.358 (9.1) | Gold | 471 |
| ALNN-1/0-516 | #1/0 AWG | 1/0-1 AWG | 5/16 | 0.343 (8.7) | 0.875 (22.2) | 1.070 (27.2) | 2.301 (58.4) | 0.569 (14.5) | 0.353 (9.0) | 0.599 (15.2) | 0.385 (9.8) | Tan | 296 |
| ALNN-2/0-38 | #2/0 AWG | 2/0-1 AWG | 3/8 | 0.406 (10.3) | 0.875 (22.2) | 1.355 (34.4) | 2.626 (66.7) | 0.644 (16.4) | 0.414 (10.5) | 0.674 (17.1) | 0.432 (11.0) | Olive | 297 |
| ALNN-3/0-38 | #3/0 AWG | 3/0-1 AWG | 3/8 | 0.406 (10.3) | 0.875 (22.2) | 1.355 (34.4) | 2.669 (67.8) | 0.731 (18.6) | 0.414 (10.5) | 0.761 (19.3) | 0.495 (12.6) | Ruby | 467 |
| ALNN-3/0-12 | #3/0 AWG | 3/0-1 AWG | 1/2 | 0.562 (14.3) | 1.250 (31.8) | 1.355 (34.4) | 3.044 (77.3) | 0.731 (18.6) | 0.546 (13.9) | 0.761 (19.3) | 0.495 (12.6) | Ruby | 467 |
| ALNN-4/0-38 | #4/0 AWG | 4/0-1 AWG | 3/8 | 0.406 (10.3) | 0.875 (22.2) | 1.535 (39.0) | 2.901 (73.7) | 0.824 (20.9) | 0.414 (10.5) | 0.854 (21.7) | 0.553 (14.0) | White | 298 |
| ALNN-4/0-12 | #4/0 AWG | 4/0-1 AWG | 1/2 | 0.562 (14.3) | 1.250 (31.8) | 1.535 (39.0) | 3.276 (83.2) | 0.824 (20.9) | 0.546 (13.9) | 0.854 (21.7) | 0.553 (14.0) | White | 298 |
| ALNN-250-38 | 250kcmil | 250kcmil-1/0 AWG | 3/8 | 0.406 (10.3) | 0.875 (22.2) | 1.535 (39.0) | 2.941 (74.7) | 0.894 (22.7) | 0.414 (10.5) | 0.924 (23.5) | 0.595 (15.1) | Red | 324 |
| ALNN-250-12 | 250kcmil | 250kcmil-1/0 AWG | 1/2 | 0.562 (14.3) | 1.250 (31.8) | 1.535 (39.0) | 3.316 (84.2) | 0.894 (22.7) | 0.546 (13.9) | 0.924 (23.5) | 0.595 (15.1) | Red | 324 |
| ALNN-300-38 | 300kcmil | 300kcmil-2/0 AWG | 3/8 | 0.406 (10.3) | 0.875 (22.2) | 1.535 (39.0) | 2.997 (76.1) | 0.980 (24.9) | 0.414 (10.5) | 1.010 (25.7) | 0.650 (16.5) | Blue | 470 |
| ALNN-300-12 | 300kcmil | 300kcmil-2/0 AWG | 1/2 | 0.562 (14.3) | 1.250 (31.8) | 1.535 (39.0) | 3.372 (85.6) | 0.980 (24.9) | 0.546 (13.9) | 1.010 (25.7) | 0.650 (16.5) | Blue | 470 |
| ALNN-350-12 | 350kcmil | 350kcmil-3/0 AWG | 1/2 | 0.562 (14.3) | 1.250 (31.8) | 2.353 (59.8) | 4.226 (107.3) | 1.075 (27.3) | 0.546 (13.9) | 1.105 (28.1) | 0.720 (18.3) | Brown | 299 |
| ALNN-400-12 | 400kcmil | 400kcmil-4/0 AWG | 1/2 | 0.562 (14.3) | 1.250 (31.8) | 2.303 (58.5) | 4.220 (107.2) | 1.158 (29.4) | 0.546 (13.9) | 1.188 (30.2) | 0.762 (19.4) | Green | 472 |
| ALNN-400-58 | 400kcmil | 400kcmil-4/0 AWG | 5/8 | 0.656 (16.7) | 1.437 (36.5) | 2.303 (58.5) | 4.407 (111.9) | 1.158 (29.4) | 0.671 (17.0) | 1.188 (30.2) | 0.762 (19.4) | Green | 472 |
| ALNN-500-12 | 500kcmil | 500kcmil-5/0 AWG | 1/2 | 0.562 (14.3) | 1.250 (31.8) | 2.565 (65.2) | 4.547 (115.5) | 1.285 (32.6) | 0.546 (13.9) | 1.315 (33.4) | 0.854 (21.7) | Pink | 300 |
| ALNN-500-58 | 500kcmil | 500kcmil-5/0 AWG | 5/8 | 0.656 (16.7) | 1.437 (36.5) | 2.565 (65.2) | 4.734 (120.2) | 1.285 (32.6) | 0.671 (17.0) | 1.315 (33.4) | 0.854 (21.7) | Pink | 300 |
| ALNN-600-12 | 600kcmil | 600kcmil-250kcmil | 1/2 | 0.562 (14.3) | 1.250 (31.8) | 2.685 (68.2) | 4.744 (120.5) | 1.410 (35.8) | 0.546 (13.9) | 1.440 (36.6) | 0.920 (23.4) | Black | 473 |
| ALNN-600-58 | 600kcmil | 600kcmil-250kcmil | 5/8 | 0.656 (16.7) | 1.437 (36.5) | 2.685 (68.2) | 4.931 (125.2) | 1.410 (35.8) | 0.671 (17.0) | 1.440 (36.6) | 0.920 (23.4) | Black | 473 |
| ALNN-700/750-12 | 700 / 750kcmil | 750kcmil-500kcmil, 900kcmil compact Al** | 1/2 | 0.562 (14.3) | 1.250 (31.8) | 2.964 (75.3) | 5.116 (129.9) | 1.430 (36.3) | 0.546 (13.9) | 1.460 (37.1) | 1.030 (26.2) | Yellow | 936 |
| ALNN-700/750-58 | 700 / 750kcmil | 750kcmil-500kcmil, 900kcmil compact Al** | 5/8 | 0.656 (16.7) | 1.437 (36.5) | 2.964 (75.3) | 5.303 (134.7) | 1.430 (36.3) | 0.671 (17.0) | 1.460 (37.1) | 1.030 (26.2) | Yellow | 936 |
| ALNN-1000-12 | 1000kcmil | 1000kcmil-750kcmil | 1/2 | 0.562 (14.3) | 1.250 (31.8) | 2.996 (76.1) | 5.271 (133.9) | 1.578 (40.1) | 0.546 (13.9) | 1.840 (46.7) | 1.180 (30.0) | Brown | P302 |
| ALNN-1000-58 | 1000kcmil | 1000kcmil-750kcmil | 5/8 | 0.656 (16.7) | 1.437 (36.5) | 2.996 (76.1) | 5.458 (138.6) | 1.578 (40.1) | 0.671 (17.0) | 1.840 (46.7) | 1.180 (30.0) | Brown | P302 |

Tested to UL 486A/B, UL File E6207

For Tool and Die Information Refer to Tooling Information Page Series: ALNS, ALND, ALNN, ASN

* When installed with specified dieless tools ** UL Listed 900kcmil compact Al

SureCrimp Aluminum Compression Lugs

Narrow Tang, 2 Hole, w/o Sight Hole

Conductor Range: 300kcmil - #4



A

TYPE ALNN

Features

- Manufactured from high strength aluminum alloy
- Electro-Tin plated
- Chamfered entry
- Color coded end cap
- Ink marked
- Two bolt hole pattern
- Pre-filled with De-Ox oxide inhibiting compound
- Range taking
- Narrow Tang
- Suitable for use in circuits rated 35KV or less, proper high voltage spacing and insulation techniques must be used
- Dual rated AL9CU to 90° C/194° F

Benefits

- Offers maximum conductivity and excellent crimping characteristics
- Provides low contact resistance
- For easy conductor insertion
- Identifies the proper compression die
- For easy identification and proper location of crimps
- Provides maximum surface contact, secure attachment, and stabilization
- Prevents oxides from forming
- Permits inventories to be kept to a minimum
- Side by side mounting
- Application versatility
- For use with copper or aluminum conductor

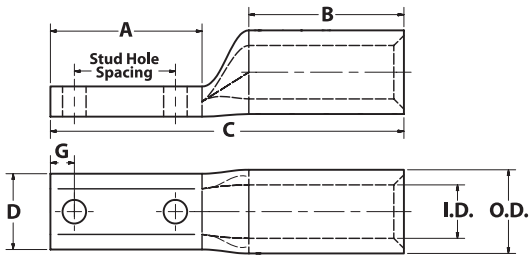

| Catalog Number | Wire Size | Expanded Wire Size* | Bolt Size | Stud Hole Dia. | Stud Hole Spacing | Dimensions - in. (mm) | | | | | | | Die Color Code | Die Index |
|-----------------|-----------|---------------------|-----------|----------------|-------------------|-----------------------|--------------|---------------|--------------|--------------|--------------|--------------|----------------|-----------|
| | | | | | | A | B | C | D | G | O.D. | I.D. | | |
| ALNN-4-14-1 | #4 AWG | 4-6 AWG | 1/4 | 0.281 (7.1) | 1.000 (25.4) | 1.687 (42.8) | 0.920 (23.4) | 2.841 (72.2) | 0.412 (10.5) | 0.321 (8.2) | 0.427 (10.8) | 0.247 (6.3) | Green | 375 |
| ALNN-2-14-1 | #2 AWG | 2-6 AWG | 1/4 | 0.281 (7.1) | 1.000 (25.4) | 1.687 (42.8) | 0.970 (24.6) | 2.943 (74.8) | 0.495 (12.6) | 0.321 (8.2) | 0.525 (13.3) | 0.307 (7.8) | Pink | 348 |
| ALNN-1-14-1 | #1 AWG | 1-2 AWG | 1/4 | 0.281 (7.1) | 1.000 (25.4) | 1.687 (42.8) | 0.970 (24.6) | 2.987 (75.9) | 0.514 (13.1) | 0.321 (8.2) | 0.544 (13.8) | 0.358 (9.1) | Gold | 471 |
| ALNN-1/0-14-1 | 1/0 AWG | 1/0-1 AWG | 1/4 | 0.281 (7.1) | 1.000 (25.4) | 1.687 (42.8) | 1.070 (27.2) | 2.987 (75.9) | 0.569 (14.5) | 0.321 (8.2) | 0.599 (15.2) | 0.385 (9.8) | Tan | 296 |
| ALNN-2/0-38-1 | 2/0 AWG | 2/0-1 AWG | 3/8 | 0.406 (10.3) | 1.000 (25.4) | 1.937 (49.2) | 1.355 (34.4) | 3.688 (93.7) | 0.644 (16.4) | 0.414 (10.5) | 0.674 (17.1) | 0.432 (11.0) | Olive | 297 |
| ALNN-2/0-38-134 | 2/0 AWG | 2/0-1 AWG | 3/8 | 0.406 (10.3) | 1.750 (44.5) | 2.625 (66.7) | 1.355 (34.4) | 4.376 (111.2) | 0.644 (16.4) | 0.414 (10.5) | 0.674 (17.1) | 0.432 (11.0) | Olive | 297 |
| ALNN-3/0-38-1 | 3/0 AWG | 3/0-1 AWG | 3/8 | 0.406 (10.3) | 1.000 (25.4) | 1.937 (49.2) | 1.355 (34.4) | 3.731 (94.8) | 0.731 (18.6) | 0.414 (10.5) | 0.761 (19.3) | 0.495 (12.6) | Ruby | 467 |
| ALNN-3/0-38-134 | 3/0 AWG | 3/0-1 AWG | 3/8 | 0.406 (10.3) | 1.750 (44.5) | 2.625 (66.7) | 1.355 (34.4) | 4.419 (112.2) | 0.731 (18.6) | 0.414 (10.5) | 0.761 (19.3) | 0.495 (12.6) | Ruby | 467 |
| ALNN-3/0-12-134 | 3/0 AWG | 3/0-1 AWG | 1/2 | 0.562 (14.3) | 1.750 (44.5) | 3.000 (76.2) | 1.355 (34.4) | 4.794 (121.8) | 0.731 (18.6) | 0.546 (13.9) | 0.761 (19.3) | 0.495 (12.6) | Ruby | 467 |
| ALNN-4/0-38-1 | 4/0 AWG | 4/0-1 AWG | 3/8 | 0.406 (10.3) | 1.000 (25.4) | 1.937 (49.2) | 1.535 (39.0) | 3.963 (100.7) | 0.824 (20.9) | 0.414 (10.5) | 0.854 (21.7) | 0.553 (14.0) | White | 298 |
| ALNN-4/0-38-134 | 4/0 AWG | 4/0-1 AWG | 3/8 | 0.406 (10.3) | 1.750 (44.5) | 2.625 (66.7) | 1.535 (39.0) | 4.651 (118.1) | 0.824 (20.9) | 0.414 (10.5) | 0.854 (21.7) | 0.553 (14.0) | White | 298 |
| ALNN-4/0-12-1 | 4/0 AWG | 4/0-1 AWG | 1/2 | 0.562 (14.3) | 1.000 (25.4) | 2.125 (54.0) | 1.535 (39.0) | 4.151 (105.4) | 0.824 (20.9) | 0.546 (13.9) | 0.854 (21.7) | 0.553 (14.0) | White | 298 |
| ALNN-4/0-12-134 | 4/0 AWG | 4/0-1 AWG | 1/2 | 0.562 (14.3) | 1.750 (44.5) | 3.000 (76.2) | 1.535 (39.0) | 5.026 (127.7) | 0.824 (20.9) | 0.546 (13.9) | 0.854 (21.7) | 0.553 (14.0) | White | 298 |
| ALNN-250-38-1 | 250kcmil | 250kcmil-1/0 AWG | 3/8 | 0.406 (10.3) | 1.000 (25.4) | 1.937 (49.2) | 1.535 (39.0) | 4.003 (101.7) | 0.894 (22.7) | 0.414 (10.5) | 0.924 (23.5) | 0.595 (15.1) | Red | 324 |
| ALNN-250-38-134 | 250kcmil | 250kcmil-1/0 AWG | 3/8 | 0.406 (10.3) | 1.750 (44.5) | 2.625 (66.7) | 1.535 (39.0) | 4.691 (119.2) | 0.894 (22.7) | 0.414 (10.5) | 0.924 (23.5) | 0.595 (15.1) | Red | 324 |
| ALNN-250-12-1 | 250kcmil | 250kcmil-1/0 AWG | 1/2 | 0.562 (14.3) | 1.000 (25.4) | 2.125 (54.0) | 1.535 (39.0) | 4.191 (106.5) | 0.894 (22.7) | 0.546 (13.9) | 0.924 (23.5) | 0.595 (15.1) | Red | 324 |
| ALNN-250-12-134 | 250kcmil | 250kcmil-1/0 AWG | 1/2 | 0.562 (14.3) | 1.750 (44.5) | 3.000 (76.2) | 1.535 (39.0) | 5.066 (128.7) | 0.894 (22.7) | 0.546 (13.9) | 0.924 (23.5) | 0.595 (15.1) | Red | 324 |
| ALNN-300-38-1 | 300kcmil | 300kcmil-2/0 AWG | 3/8 | 0.406 (10.3) | 1.000 (25.4) | 1.937 (49.2) | 1.535 (39.0) | 4.059 (103.1) | 0.980 (24.9) | 0.414 (10.5) | 1.010 (25.7) | 0.650 (16.5) | Blue | 470 |
| ALNN-300-38-134 | 300kcmil | 300kcmil-2/0 AWG | 3/8 | 0.406 (10.3) | 1.750 (44.5) | 2.625 (66.7) | 1.535 (39.0) | 4.747 (120.6) | 0.980 (24.9) | 0.414 (10.5) | 1.010 (25.7) | 0.650 (16.5) | Blue | 470 |
| ALNN-300-12-1 | 300kcmil | 300kcmil-2/0 AWG | 1/2 | 0.562 (14.3) | 1.000 (25.4) | 2.125 (54.0) | 1.535 (39.0) | 4.247 (107.9) | 0.980 (24.9) | 0.546 (13.9) | 1.010 (25.7) | 0.650 (16.5) | Blue | 470 |
| ALNN-300-12-134 | 300kcmil | 300kcmil-2/0 AWG | 1/2 | 0.562 (14.3) | 1.750 (44.5) | 3.000 (76.2) | 1.535 (39.0) | 5.122 (130.1) | 0.980 (24.9) | 0.546 (13.9) | 1.010 (25.7) | 0.650 (16.5) | Blue | 470 |

Tested to UL 486A/B, UL File E6207

For Tool and Die Information Refer to Tooling Information Page Series: ALNS, ALND, ALNN, ASN

* When installed with specified dieless tools

** UL Listed 900kcmil compact Al

SureCrimp Aluminum Compression Lugs

Narrow Tang, 2 Hole, w/o Sight Hole

Conductor Range: 1000kcmil - 350kcmil



TYPE ALNN

Features

- Manufactured from high strength aluminum alloy
- Electro-Tin plated
- Chamfered entry
- Color coded end cap
- Ink marked
- Two bolt hole pattern
- Pre-filled with De-Ox oxide inhibiting compound
- Range taking
- Narrow Tang
- Suitable for use in circuits rated 35KV or less, proper high voltage spacing and insulation techniques must be used
- Dual rated AL9CU to 90° C/194° F

Benefits

- Offers maximum conductivity and excellent crimping characteristics
- Provides low contact resistance
- For easy conductor insertion
- Identifies the proper compression die
- For easy identification and proper location of crimps
- Provides maximum surface contact, secure attachment, and stabilization
- Prevents oxides from forming
- Permits inventories to be kept to a minimum
- Side by side mounting
- Application versatility
- For use with copper or aluminum conductor

A

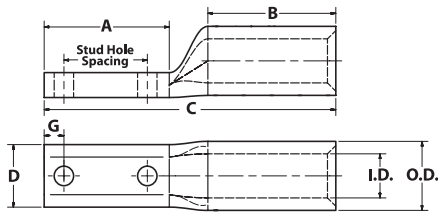

| Catalog Number | Wire Size | Expanded Wire Size* | Bolt Size | Stud Hole Dia. | Stud Hole Spacing | Dimensions - in. (mm) | | | | | | | Die Color Code | Die Index |
|---------------------|--------------|------------------------------------------|-----------|----------------|-------------------|-----------------------|--------------|---------------|--------------|--------------|--------------|--------------|----------------|-----------|
| | | | | | | A | B | C | D | G | O.D. | I.D. | | |
| ALNN-350-38-1 | 350kcmil | 350kcmil-3/0 AWG | 3/8 | 0.406 (10.3) | 1.000 (25.4) | 1.937 (49.2) | 2.353 (59.8) | 4.913 (124.8) | 1.075 (27.3) | 0.414 (10.5) | 1.105 (28.1) | 0.720 (18.3) | Brown | 299 |
| ALNN-350-38-134 | 350kcmil | 350kcmil-3/0 AWG | 3/8 | 0.406 (10.3) | 1.750 (44.5) | 2.625 (66.7) | 2.353 (59.8) | 5.601 (142.3) | 1.075 (27.3) | 0.414 (10.5) | 1.105 (28.1) | 0.720 (18.3) | Brown | 299 |
| ALNN-350-12-1 | 350kcmil | 350kcmil-3/0 AWG | 1/2 | 0.562 (14.3) | 1.000 (25.4) | 2.125 (54.0) | 2.353 (59.8) | 5.101 (129.6) | 1.075 (27.3) | 0.546 (13.9) | 1.105 (28.1) | 0.720 (18.3) | Brown | 299 |
| ALNN-350-12-134 | 350kcmil | 350kcmil-3/0 AWG | 1/2 | 0.562 (14.3) | 1.750 (44.5) | 3.000 (76.2) | 2.353 (59.8) | 5.976 (151.8) | 1.075 (27.3) | 0.546 (13.9) | 1.105 (28.1) | 0.720 (18.3) | Brown | 299 |
| ALNN-400-38-1 | 400kcmil | 400kcmil-4/0 AWG | 3/8 | 0.406 (10.3) | 1.000 (25.4) | 1.937 (49.2) | 2.303 (58.5) | 4.907 (124.6) | 1.158 (29.4) | 0.414 (10.5) | 1.188 (30.2) | 0.762 (19.4) | Green | 472 |
| ALNN-400-38-134 | 400kcmil | 400kcmil-4/0 AWG | 3/8 | 0.406 (10.3) | 1.750 (44.5) | 2.625 (66.7) | 2.303 (58.5) | 5.595 (142.1) | 1.158 (29.4) | 0.414 (10.5) | 1.188 (30.2) | 0.762 (19.4) | Green | 472 |
| ALNN-400-12-1 | 400kcmil | 400kcmil-4/0 AWG | 1/2 | 0.562 (14.3) | 1.000 (25.4) | 2.125 (54.0) | 2.303 (58.5) | 5.095 (129.4) | 1.158 (29.4) | 0.546 (13.9) | 1.188 (30.2) | 0.762 (19.4) | Green | 472 |
| ALNN-400-12-134 | 400kcmil | 400kcmil-4/0 AWG | 1/2 | 0.562 (14.3) | 1.750 (44.5) | 3.000 (76.2) | 2.303 (58.5) | 5.970 (151.6) | 1.158 (29.4) | 0.546 (13.9) | 1.188 (30.2) | 0.762 (19.4) | Green | 472 |
| ALNN-500-38-1 | 500kcmil | 500kcmil-4/0 AWG | 3/8 | 0.406 (10.3) | 1.000 (25.4) | 1.937 (49.2) | 2.565 (65.2) | 5.234 (132.9) | 1.285 (32.6) | 0.414 (10.5) | 1.315 (33.4) | 0.854 (21.7) | Pink | 300 |
| ALNN-500-38-134 | 500kcmil | 500kcmil-4/0 AWG | 3/8 | 0.406 (10.3) | 1.750 (44.5) | 2.625 (66.7) | 2.565 (65.2) | 5.922 (150.4) | 1.285 (32.6) | 0.414 (10.5) | 1.315 (33.4) | 0.854 (21.7) | Pink | 300 |
| ALNN-500-12-1 | 500kcmil | 500kcmil-4/0 AWG | 1/2 | 0.562 (14.3) | 1.000 (25.4) | 2.125 (54.0) | 2.565 (65.2) | 5.422 (137.7) | 1.285 (32.6) | 0.546 (13.9) | 1.315 (33.4) | 0.854 (21.7) | Pink | 300 |
| ALNN-500-12-134 | 500kcmil | 500kcmil-4/0 AWG | 1/2 | 0.562 (14.3) | 1.750 (44.5) | 3.000 (76.2) | 2.565 (65.2) | 6.297 (159.9) | 1.285 (32.6) | 0.546 (13.9) | 1.315 (33.4) | 0.854 (21.7) | Pink | 300 |
| ALNN-600-38-1 | 600kcmil | 600kcmil-250kcmil | 3/8 | 0.406 (10.3) | 1.000 (25.4) | 1.937 (49.2) | 2.685 (68.2) | 5.431 (137.9) | 1.410 (35.8) | 0.414 (10.5) | 1.440 (36.6) | 0.920 (23.4) | Black | 473 |
| ALNN-600-38-134 | 600kcmil | 600kcmil-250kcmil | 3/8 | 0.406 (10.3) | 1.750 (44.5) | 2.625 (66.7) | 2.685 (68.2) | 6.119 (155.4) | 1.410 (35.8) | 0.414 (10.5) | 1.440 (36.6) | 0.920 (23.4) | Black | 473 |
| ALNN-600-12-1 | 600kcmil | 600kcmil-250kcmil | 1/2 | 0.562 (14.3) | 1.000 (25.4) | 2.125 (54.0) | 2.685 (68.2) | 5.619 (142.7) | 1.410 (35.8) | 0.546 (13.9) | 1.440 (36.6) | 0.920 (23.4) | Black | 473 |
| ALNN-600-12-134 | 600kcmil | 600kcmil-250kcmil | 1/2 | 0.562 (14.3) | 1.750 (44.5) | 3.000 (76.2) | 2.685 (68.2) | 6.494 (164.9) | 1.410 (35.8) | 0.546 (13.9) | 1.440 (36.6) | 0.920 (23.4) | Black | 473 |
| ALNN-700/750-38-1 | 700/750kcmil | 750kcmil-500kcmil, 900kcmil compact Al** | 3/8 | 0.406 (10.3) | 1.000 (25.4) | 1.937 (49.2) | 2.964 (75.3) | 5.803 (147.4) | 1.430 (36.3) | 0.414 (10.5) | 1.460 (37.1) | 1.030 (26.2) | Yellow | 936 |
| ALNN-700/750-38-134 | 700/750kcmil | 750kcmil-500kcmil, 900kcmil compact Al** | 3/8a | 0.406 (10.3) | 1.750 (44.5) | 2.625 (66.7) | 2.964 (75.3) | 6.491 (164.9) | 1.430 (36.3) | 0.414 (10.5) | 1.460 (37.1) | 1.030 (26.2) | Yellow | 936 |
| ALNN-700/750-12-1 | 700/750kcmil | 750kcmil-500kcmil, 900kcmil compact Al** | 1/2 | 0.562 (14.3) | 1.000 (25.4) | 2.125 (54.0) | 2.964 (75.3) | 5.991 (152.2) | 1.430 (36.3) | 0.546 (13.9) | 1.460 (37.1) | 1.030 (26.2) | Yellow | 936 |
| ALNN-700/750-12-134 | 700/750kcmil | 750kcmil-500kcmil, 900kcmil compact Al** | 1/2 | 0.562 (14.3) | 1.750 (44.5) | 3.000 (76.2) | 2.964 (75.3) | 6.866 (174.4) | 1.430 (36.3) | 0.546 (13.9) | 1.460 (37.1) | 1.030 (26.2) | Yellow | 936 |
| ALNN-1000-38-1 | 1000kcmil | 1000kcmil-750kcmil | 3/8 | 0.406 (10.3) | 1.000 (25.4) | 1.937 (49.2) | 2.996 (76.1) | 5.958 (151.3) | 1.578 (40.1) | 0.414 (10.5) | 1.840 (46.7) | 1.180 (30.0) | Brown | P302 |
| ALNN-1000-38-134 | 1000kcmil | 1000kcmil-750kcmil | 3/8 | 0.406 (10.3) | 1.750 (44.5) | 2.625 (66.7) | 2.996 (76.1) | 6.646 (168.8) | 1.578 (40.1) | 0.414 (10.5) | 1.840 (46.7) | 1.180 (30.0) | Brown | P302 |
| ALNN-1000-12-1 | 1000kcmil | 1000kcmil-750kcmil | 1/2 | 0.562 (14.3) | 1.000 (25.4) | 2.125 (54.0) | 2.996 (76.1) | 6.146 (156.1) | 1.578 (40.1) | 0.546 (13.9) | 1.840 (46.7) | 1.180 (30.0) | Brown | P302 |
| ALNN-1000-12-134 | 1000kcmil | 1000kcmil-750kcmil | 1/2 | 0.562 (14.3) | 1.750 (44.5) | 3.000 (76.2) | 2.996 (76.1) | 7.021 (178.3) | 1.578 (40.1) | 0.546 (13.9) | 1.840 (46.7) | 1.180 (30.0) | Brown | P302 |

Tested to UL 486A/B, UL File E6207 For Tool and Die Information Refer to Tooling Information Page Series: ALNS, ALND, ALNN, ASN

* When installed with specified dieless tools ** UL Listed 900kcmil compact Al

SureCrimp Aluminum Compression Sleeves

Dual Rated

Conductor Range: 1000kcmil - #8

RoHS
Compliant

UL
LISTED
453G

SA
LR-29601

A

**TYPE
ASN**

Features

- Manufactured from high strength aluminum alloy
- Electro-Tin plated
- Chamfered entry
- Color coded end cap
- Ink marked
- Pre-filled with De-Ox oxide inhibiting compound
- Range taking
- Suitable for use in circuits rated 35KV or less, proper high voltage spacing and insulation techniques must be used
- Dual rated AL9CU to 90° C/194° F

Benefits

- Offers maximum conductivity and excellent crimping characteristics
- Provides low contact resistance
- For easy conductor insertion
- Identifies the proper compression die
- For easy identification and proper location of crimps
- Prevents oxides from forming & promotes connector longevity
- Permits inventories to be kept to a minimum
- Application versatility
- For use with aluminum or copper conductor

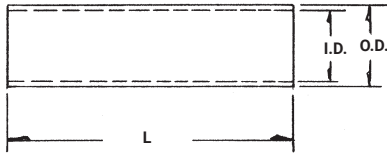

| Catalog Number | Wire Size | Expanded Wire Size* | Dimensions - in. (mm) | | | Die Color Code | Die Index |
|----------------|--------------|---------------------------------------------|-----------------------|--------------|--------------|----------------|-----------|
| | | | Length | O.D. | I.D. | | |
| ASN-8 | #8 AWG | 8 AWG | 1.806 (45.9) | 0.300 (7.6) | 0.155 (3.9) | Blue | 374 |
| ASN-6 | #6 AWG | 6 AWG | 1.205 (30.6) | 0.338 (8.6) | 0.194 (4.9) | Gray | 346 |
| ASN-4 | #4 AWG | 4-6 AWG | 2.222 (56.4) | 0.427 (10.8) | 0.247 (6.3) | Green | 375 |
| ASN-2 | #2 AWG | 2-6 AWG | 1.940 (49.3) | 0.525 (13.3) | 0.307 (7.8) | Pink | 348 |
| ASN-1 | #1 AWG | 1-2 AWG | 1.940 (49.3) | 0.544 (13.8) | 0.358 (9.1) | Gold | 471 |
| ASN-1/0 | 1/0 AWG | 1/0-1 AWG | 2.573 (65.4) | 0.599 (15.2) | 0.385 (9.8) | Tan | 296 |
| ASN-2/0 | 2/0 AWG | 2/0-1 AWG | 2.710 (68.8) | 0.674 (17.1) | 0.432 (11.0) | Olive | 297 |
| ASN-3/0 | 3/0 AWG | 3/0-1 AWG | 2.710 (68.8) | 0.761 (19.3) | 0.495 (12.6) | Ruby | 467 |
| ASN-4/0 | 4/0 AWG | 4/0-1 AWG | 3.070 (78.0) | 0.854 (21.7) | 0.553 (14.0) | White | 298 |
| ASN-250 | 250kcmil | 250kcmil-1/0 AWG | 3.735 (94.9) | 0.924 (23.5) | 0.595 (15.1) | Red | 324 |
| ASN-300 | 300kcmil | 300kcmil-2/0 AWG | 3.070 (78.0) | 1.010 (25.7) | 0.650 (16.5) | Blue | 470 |
| ASN-350 | 350kcmil | 350kcmil-3/0 AWG | 5.125 (130.2) | 1.105 (28.1) | 0.720 (18.3) | Brown | 299 |
| ASN-400 | 400kcmil | 400kcmil-4/0 AWG | 4.606 (117.0) | 1.188 (30.2) | 0.762 (19.4) | Green | 472 |
| ASN-500 | 500kcmil | 500kcmil-4/0 AWG | 5.130 (130.3) | 1.315 (33.4) | 0.854 (21.7) | Pink | 300 |
| ASN-600 | 600kcmil | 600kcmil-250kcmil | 5.370 (136.4) | 1.440 (36.6) | 0.920 (23.4) | Black | 473 |
| ASN-700/750 | 700/750kcmil | 750kcmil-500kcmil, 900kcmil compact Al** | 5.928 (150.6) | 1.460 (37.1) | 1.030 (26.2) | Yellow | 936 |
| ASN-1000 | 1000kcmil | 1000kcmil-750kcmil | 5.992 (152.2) | 1.840 (46.7) | 1.180 (30.0) | Brown | P302 |

Tested to UL 486A/B, UL File E6207

For Tool and Die Information Refer to Tooling Information Page Series: ALNS, ALND, ALNN, ASN

* When installed with specified dieless tools

** UL Listed 900kcmil compact Al

Stacking Adaptor For Compression Lugs

RoHS
Compliant



TYPE
ASL

Features

- Electro-tin plated
- Manufactured from high strength aluminum alloy
- Two sizes cover a wire range from 750 kcmil-1/0
- Unique design
- Versatile
- Suitable for use in circuits rated 35KV or less, proper high voltage spacing and insulation techniques must be used
- Rated to 90° C/194° F

Benefits

- Provides low contact resistance
- Can be used with both aluminum and copper terminals
- Permits inventories to be kept to a minimum
- Allows vertical stacking to minimize space requirements
- Can be used with copper and/or aluminum connectors
- Application versatility

A

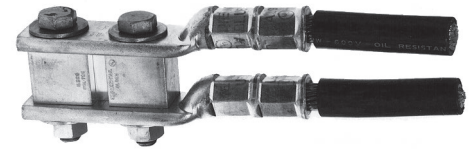
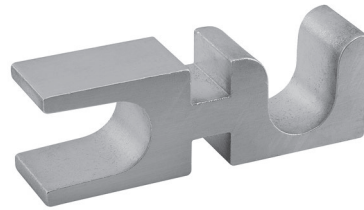
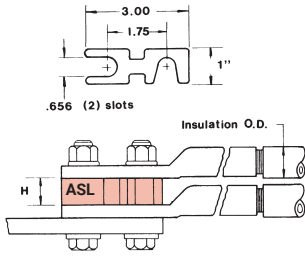

| Catalog Number | Wire Range | Insulation O.D. | H |
|----------------|--------------|-----------------|-------|
| ASL-250 | 250kcmil-1/0 | 55/64 | 3/4 |
| ASL-750 | 750kcmil-1/0 | 1-3/8 | 1-1/4 |

Tested to UL 486A/B, UL File E6207

All wire sizes, unless noted otherwise, are American Wire Gauge (AWG)

nVent ILSCO Flex2Code Pin Adaptors

Conductor Range 1000kcmil - 6AWG



A TYPE F2C

Features

- All copper adaptor design
- Compact design, smallest in the industry
- Only requires one crimp
- Certified with nVent ILSCO and major competitor's tools
- Supplied with insulating cover
- UL486A/B Listed for 600V, 90° C/194° F
- UL467 Listed for direct bury 500 kcmil - 6 AWG
- Color coded
- Chamfered entry
- Electro-tin plated

Benefits

- Allows flex conductors to be used with equipment rated for code conductors
- Saves space inside electrical panels
- Saves installation time
- Reduces inventory requirements
- Insulates conductor surface
- Ensures reliability
- For grounding and bonding applications
- Identifies the proper compression die
- For easy conductor insertion
- Provides low contact resistance

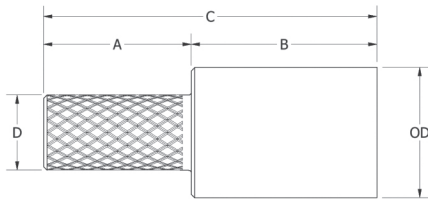

| Catalog Number | Pin Size | Flex Conductor Range | Expanded Conductor Range Class B/C Only | Dimensions (in.) | | | | Die Color | Die Index | Cover | O.D. |
|----------------|-----------|--------------------------|-----------------------------------------|------------------|-------|-------|------|-----------|-----------|--------|-------|
| | | | | A | B | C | D | | | | |
| F2C-4-4 | #4 | #4 FLEX | 3-6 AWG | .750 | 1.075 | 1.825 | .204 | White | I-29 | PCC-2 | .375 |
| F2C-2-2 | #2 | #2 FLEX | 1-6 AWG | .750 | 1.138 | 1.880 | .258 | Green | I-37 | PCC-3 | .468 |
| F2C-1-1 | #1 | #1 FLEX | 1/0-6 AWG | .750 | 1.138 | 1.880 | .289 | Pink | I-42 | PCC-4 | .515 |
| F2C-1/0-1/0 | 1/0 | 1/0 FLEX | 2/0-4 AWG | .870 | 1.200 | 2.070 | .325 | Black | I-45 | PCC-5 | .562 |
| F2C-2/0-2/0 | 2/0 | 2/0 FLEX | 3/0 - 2 AWG | .870 | 1.263 | 2.133 | .365 | Orange | I-50 | PCC-5 | .609 |
| F2C-3/0-3/0 | 3/0 | 3/0 FLEX | 4/0 - 1 AWG | .900 | 1.263 | 2.163 | .410 | Purple | I-54 | PCC-6 | .687 |
| F2C-4/0-4/0 | 4/0 | 4/0 FLEX | 250 kcmil - 1/0 AWG | 1.000 | 1.325 | 2.325 | .460 | Yellow | I-62 | PCC-7 | .750 |
| F2C-250-250 | 250 kcmil | 250 G,H FLEX | 300 kcmil - 2/0 AWG | 1.100 | 1.325 | 2.425 | .500 | White | I-66 | PCC-7 | .812 |
| F2C-262-250 | 250 kcmil | 250 I,K,M FLEX 262.2 DLO | 350 kcmil - 3/0 AWG | 1.100 | 1.388 | 2.488 | .500 | Red | I-71 | PCC-8 | .890 |
| F2C-313-350 | 350 kcmil | 300 FLEX 313.1 DLO | 400 kcmil - 4/0 AWG | 1.250 | 1.450 | 2.700 | .592 | Blue | I-76 | PCC-9 | .937 |
| F2C-373-350 | 350 kcmil | 350 FLEX 373.7 DLO | 500 kcmil - 250 kcmil | 1.250 | 1.638 | 2.888 | .592 | Brown | I-87 | PCC-9 | 1.062 |
| F2C-444-500 | 500 kcmil | 400 FLEX 444.4 DLO | 600 kcmil - 250 kcmil | 1.500 | 1.638 | 3.138 | .707 | Green | I-94 | PCC-10 | 1.187 |
| F2C-535-500 | 500 kcmil | 500 FLEX 535.3 DLO | 700 kcmil - 350 kcmil | 1.500 | 1.888 | 3.388 | .707 | Pink | I-99 | PCC-11 | 1.250 |
| F2C-646-600 | 600 kcmil | 600 FLEX 646.4 DLO | 750 kcmil - 500 kcmil | 1.500 | 1.888 | 3.388 | .775 | Black | I-106 | PCC-12 | 1.313 |
| F2C-777-750 | 750 kcmil | 750 FLEX 777.7 DLO | 1000 kcmil - 750 kcmil | 1.700 | 2.138 | 3.838 | .866 | White | I-125 | PCC-12 | 1.500 |

Tested to UL486A/B, UL File #E6252

Tested to UL467, UL File E34440 (500kcmil - 6 AWG only)

All wire sizes, unless noted otherwise, are American Wire Gauge (AWG)

Expanded conductor ranges only valid when installed with specified dieless tools

Unless otherwise noted FLEX includes G,H,I,K,M and DLO

Copper Pigtail Adaptor

Dual Rated

Conductor Range: 3/0-#6



TYPE
CPM

Features

- Barrel manufactured from high strength aluminum alloy
- Pigtail manufactured from high conductivity copper
- Chamfered barrel
- UL Listed and CSA Certified for 600 volts, 90° C/194° F
- Clearly marked with wire size and die index for nVent ILSCO tools, proper number and location of crimps
- Prefilled with De-Ox
- Color coded end caps inserted in barrel
- Supplied with insulating cover
- Rated for full ampacity of incoming conductor

Benefits

- Allows insertion into equipment supplied with either copper or aluminum connectors
- Provides maximum conductivity and excellent crimping characteristics
- Provides easy conductor insertion
- Ensures reliability for copper and aluminum conductors
- Provides easy identification and tooling recommendation
- Prevents oxides from forming
- Prevents foreign materials from entering the connector prior to usage and color code identifies the proper compression die
- Eliminates taping

A

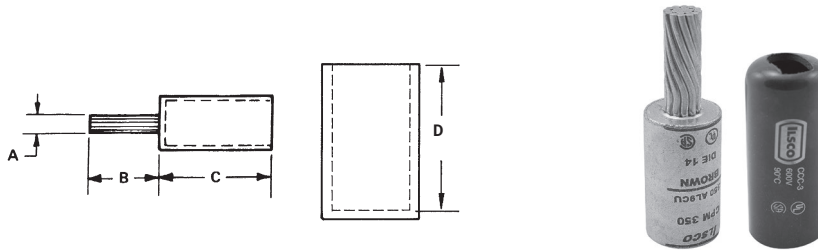

| Catalog Number | Wire Size | Die Color | Copper Pin Size | Dimensions (in.) | | | | O.D. | I.D. | Cover Part Numbers |
|----------------|-----------|-----------|-----------------|------------------|-------|---------|-----------|-------|-------|--------------------|
| | | | | A | B | C | D (Cover) | | | |
| CPM-6 | 6 | Orange | 8 | 1/8 | 7/8 | 1-11/32 | 1-11/16 | 21/32 | 3/16 | CCC-1 |
| CPM-4 | 4 | Orange | 6 | 3/16 | 7/8 | 1-11/32 | 1-11/16 | 21/32 | 1/4 | CCC-1 |
| CPM-2 | 2 | Orange | 4 | 15/64 | 7/8 | 1-11/32 | 1-11/16 | 21/32 | 5/16 | CCC-1 |
| CPM-1 | 1 | Orange | 3 | 17/64 | 1 | 1-11/32 | 1-11/16 | 21/32 | 23/64 | CCC-1 |
| CPM-1/0 | 1/0 | White | 2 | 19/64 | 1-1/4 | 1-19/32 | 2-3/32 | 29/32 | 25/64 | CCC-2 |
| CPM-2/0 | 2/0 | White | 1 | 11/32 | 1-1/4 | 1-19/32 | 2-3/32 | 29/32 | 7/16 | CCC-2 |
| CPM-3/0 | 3/0 | White | 1/0 | 3/8 | 1-3/8 | 1-7/8 | 2-3/32 | 29/32 | 1/2 | CCC-2 |

Tooling Information

| Catalog Number | nVent ILSCO | | | Burndy | | | | Thomas & Betts | | | Color Guide |
|----------------|----------------------------------------------------|------------------------------------------------------|-------------------------------------|------------------------------------|------------------------------------|------------------------------------|------------------------------------|-----------------------------------------------|------------------------------------------------|-----------------------------------------------|-------------|
| | ILC-12-N ILSC-12H-N Die No. No. of Crimps | ILCB-12-N ILCB-12-LIO Die No. No. of Crimps | ILC-15H Die No. No. of Crimps | 7-46 Die Index No. of Crimps | 7-35 Die Index No. of Crimps | 7-39 Die Index No. of Crimps | 7-45 Die Index No. of Crimps | 13642 12 Ton Die Index No. of Crimps | TBM 15 15 Ton Die Index No. of Crimps | 21940 40 Ton Die Index No. of Crimps | |
| CPM-6 | ILD-9 (3) | ILD-9 (3) | ILD-9 (3) | 297 (2) | 297 (2) | 297 (2) | 297 (2) | 50 (2) | 50 (2) | 50 (2) | Orange |
| CPM-4 | ILD-9 (3) | ILD-9 (3) | ILD-9 (3) | 297 (2) | 297 (2) | 297 (2) | 297 (2) | 50 (2) | 50 (2) | 50 (2) | Orange |
| CPM-2 | ILD-9 (3) | ILD-9 (3) | ILD-9 (3) | 297 (2) | 297 (2) | 297 (2) | 297 (2) | 50 (2) | 50 (2) | 50 (2) | Orange |
| CPM-1 | ILD-9 (3) | ILD-9 (3) | ILD-9 (3) | 297 (2) | 297 (2) | 297 (2) | 297 (2) | 50 (2) | 50 (2) | 50 (2) | Orange |
| CPM-1/0 | ILD-12 (1) | ILD-12 (1) | ILD-12 (1) | 324 (2) | 324 (2) | 324 (2) | 324 (2) | 76H (4) | 76 (2) | 76 (2) | White |
| CPM-2/0 | ILD-12 (1) | ILD-12 (1) | ILD-12 (1) | 324 (2) | 324 (2) | 324 (2) | 324 (2) | 76H (4) | 76 (2) | 76 (2) | White |
| CPM-3/0 | ILD-12 (1) | ILD-12 (1) | ILD-12 (1) | 324 (2) | 324 (2) | 324 (2) | 324 (2) | 76H (4) | 76 (2) | 76 (2) | White |

Tested to UL 486A/B, UL File E62525

All wire sizes, unless noted otherwise, are American Wire Gauge (AWG)

Dieless crimp tools must not be used to crimp CPM/CPML adapters. See stuffer sheet for complete information on tooling.

Copper Pigtail Adaptor

Dual Rated

Conductor Range: 600kcmil-4/0

RoHS
Compliant



A TYPE CPM

Features

- Barrel manufactured from high strength aluminum alloy
- Pigtail manufactured from high conductivity copper
- Chamfered barrel
- UL Listed and CSA Certified for 600 volts, 90° C/194° F
- Clearly marked with wire size and die index for nVent ILSCO tools, proper number and location of crimps
- Prefilled with De-Ox
- Color coded end caps inserted in barrel
- Supplied with insulating cover
- Rated for full ampacity of incoming conductor

Benefits

- Allows insertion into equipment supplied with either copper or aluminum connectors
- Provides maximum conductivity and excellent crimping characteristics
- Provides easy conductor insertion
- Ensures reliability for copper and aluminum conductors
- Provides easy identification and tooling recommendation
- Prevents oxides from forming
- Prevents foreign materials from entering the connector prior to usage and color code identifies the proper compression die
- Eliminates taping

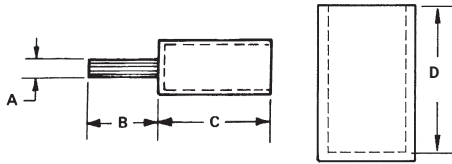

| Catalog Number | Wire Size | Die Color | Copper Pin Size | Dimensions (in.) | | | | O.D. | I.D. | Cover Part Numbers |
|----------------|-----------|-----------|-----------------|------------------|-------|--------|-----------|--------|-------|--------------------|
| | | | | A | B | C | D (Cover) | | | |
| CPM-4/0 | 4/0 | White | 2/0 | 13/32 | 1-3/8 | 1-7/8 | 2-3/32 | 29/32 | 9/16 | CCC-2 |
| CPM-250 | 250kcmil | Brown | 3/0 | 15/32 | 1-1/2 | 2-1/16 | 2-27/32 | 1-5/32 | 39/64 | CCC-3 |
| CPM-300 | 300kcmil | Brown | 4/0 | 17/32 | 1-5/8 | 2-1/16 | 2-27/32 | 1-5/32 | 21/32 | CCC-3 |
| CPM-350 | 350kcmil | Brown | 4/0 | 17/32 | 1-5/8 | 2-1/16 | 2-27/32 | 1-5/32 | 23/32 | CCC-3 |
| CPM-400 | 400kcmil | Pink | 250kcmil | 37/64 | 1-7/8 | 2-3/32 | 2-13/32 | 1-3/8 | 49/64 | CCC-4 |
| CPM-500 | 500kcmil | Pink | 350kcmil | 11/16 | 1-7/8 | 2-3/32 | 2-13/32 | 1-3/8 | 55/64 | CCC-4 |
| CPM-600 | 600kcmil | Yellow | 350kcmil | 11/16 | 1-7/8 | 2-3/4 | 3-3/32 | 1-1/2 | 59/64 | CCC-5 |

Tooling Information

| Catalog Number | nVent ILSCO | | | Burdny | | | | Thomas & Betts | | | Color Guide |
|--------------------------|--------------------------|--------------------------|--------------------------|----------------------------|----------------------------|----------------------------|----------------------------|----------------------------|----------------------------|----------------------------|-------------|
| | ILC-12-N ILSC-12H-N | ILCB-12-N ILCB-12-LIO | ILC-15H | 7-46 | 7-35 | 7-39 | 7-45 | 13642 12 Ton | TBM 15 15 Ton | 21940 40 Ton | |
| Die No. No. of Crimps | Die No. No. of Crimps | Die No. No. of Crimps | Die No. No. of Crimps | Die Index No. of Crimps | Die Index No. of Crimps | Die Index No. of Crimps | Die Index No. of Crimps | Die Index No. of Crimps | Die Index No. of Crimps | Die Index No. of Crimps | |
| CPM-4/0 | ILD-12 (1) | ILD-12 (1) | ILD-12 (1) | 324 (2) | 324 (2) | 324 (2) | 324 (2) | 76H (4) | 76 (2) | 76 (2) | White |
| CPM-250 | ILD-14 (2*) | ILD-14 (2*) | ILD-14 (2*) | 299 (2*) | 299 (2*) | 299 (2*) | 299 (2*) | 87H (2) | 87H (2) | 87 (1) | Brown |
| CPM-300 | ILD-14 (2*) | ILD-14 (2*) | ILD-14 (2*) | 299 (2*) | 299 (2*) | 299 (2*) | 299 (2*) | 87H (2) | 87H (2) | 87 (1) | Brown |
| CPM-350 | ILD-14 (2*) | ILD-14 (2*) | ILD-14 (2*) | 299 (2*) | 299 (2*) | 299 (2*) | 299 (2*) | 87H (2) | 87H (2) | 87 (1) | Brown |
| CPM-400 | ILD-16A (2*) | ILD-16A (2*) | ILD-16A (2*) | 300 (3) | 300 (3) | 300 (3) | 300 (3) | 106H (2) | 106 (1) | 106 (1) | Pink |
| CPM-500 | ILD-16A (2*) | ILD-16A (2*) | ILD-16A (2*) | 300 (3) | 300 (3) | 300 (3) | 300 (3) | 106H (2) | 106 (1) | 106 (1) | Pink |
| CPM-600 | ILD-18 (3) | ILD-18 (3) | ILD-18 (3) | 936 (3) | 936 (3) | 936 (3) | 936 (3) | 115H (3) | 115H (3) | 115 (2) | Yellow |

Tested to UL 486A/B, UL File E62525

All wire sizes, unless noted otherwise, are American Wire Gauge (AWG)

*Overlap Crimps Dieless crimp tools must not be used to crimp CPM/CPML adaptors. See stuffer sheet for complete information on tooling.

Copper Pigtail Adaptor

Dual Rated

Conductor Range: 750kcmil-500kcmil

RoHS
Compliant

UL
LISTED
941R

SA
LR-29601

TYPE
CPM
CPML

Features

- Barrel manufactured from high strength aluminum alloy
- Pigtail manufactured from high conductivity copper
- Chamfered barrel
- UL Listed and CSA Certified for 600 volts, 90° C/194° F
- Clearly marked with wire size and die index for nVent ILSCO tools, proper number and location of crimps
- Prefilled with De-Ox
- Color coded end caps inserted in barrel
- Supplied with insulating cover
- Rated for full ampacity of incoming conductor

Benefits

- Allows insertion into equipment supplied with either copper or aluminum connectors
- Provides maximum conductivity and excellent crimping characteristics
- Provides easy conductor insertion
- Ensures reliability for copper and aluminum conductors
- Provides easy identification and tooling recommendation
- Prevents oxides from forming
- Prevents foreign materials from entering the connector prior to usage and color code identifies the proper compression die
- Eliminates taping

A

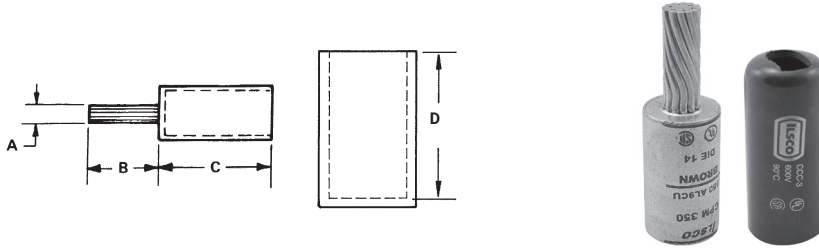

| Catalog Number | Wire Size | Die Color | Copper Pin Size | Dimensions (in.) | | | | O.D. | I.D. | Cover Part Numbers |
|----------------|-------------------|-----------|-----------------|------------------|---|--------|-----------|-------|--------|--------------------|
| | | | | A | B | C | D (Cover) | | | |
| CPM-750 | 750kcmil-700kcmil | Yellow | 500kcmil | 13/16 | 2 | 2-3/4 | 3-3/32 | 1-1/2 | 1-1/32 | CCC-5 |
| CPML-500 | 500kcmil | Pink | 350kcmil | 11/16 | 3 | 2-3/32 | 2-13/32 | 1-3/8 | 55/64 | CCC-4 |
| CPML-600 | 600kcmil | Yellow | 350kcmil | 11/16 | 3 | 2-3/4 | 3-3/32 | 1-1/2 | 59/64 | CCC-5 |
| CPML-750 | 750kcmil-700kcmil | Yellow | 500kcmil | 13/16 | 3 | 2-3/4 | 3-3/32 | 1-1/2 | 1-1/32 | CCC-5 |

Tooling Information

| Catalog Number | nVent ILSCO | | | Burndy | | | | Thomas & Betts | | | Color Guide |
|----------------|--------------------------|--------------------------|--------------------------|----------------------------|----------------------------|----------------------------|----------------------------|----------------------------|----------------------------|----------------------------|-------------|
| | ILC-12-N ILSC-12H-N | ILCB-12-N ILCB-12-LIO | ILC-15H | 7-46 | 7-35 | 7-39 | 7-45 | 13642 12 Ton | TBM 15 15 Ton | 21940 40 Ton | |
| | Die No. No. of Crimps | Die No. No. of Crimps | Die No. No. of Crimps | Die Index No. of Crimps | Die Index No. of Crimps | Die Index No. of Crimps | Die Index No. of Crimps | Die Index No. of Crimps | Die Index No. of Crimps | Die Index No. of Crimps | |
| CPM-750 | ILD-18 (3) | ILD-18 (3) | ILD-18 (3) | 936 (3) | 936 (3) | 936 (3) | 936 (3) | 115H (3) | 115H (3) | 115 (2) | Yellow |
| CPML-500 | ILD-16A (2*) | ILD-16A (2*) | ILD-16A (2*) | 300 (3) | 300 (3) | 300 (3) | 300 (3) | 106H (2) | 106 (1) | 106 (1) | Pink |
| CPML-600 | ILD-18 (3*) | ILD-18 (3*) | ILD-18 (3*) | 936 (3) | 936 (3) | 936 (3) | 936 (3) | 115H (3) | 115H (3) | 115 (2) | Yellow |
| CPML-750 | ILD-18 (3*) | ILD-18 (3*) | ILD-18 (3*) | 936 (3) | 936 (3) | 936 (3) | 936 (3) | 115H (3) | 115H (3) | 115 (2) | Yellow |

Tested to UL 486A/B, UL File E62525

All wire sizes, unless noted otherwise, are American Wire Gauge (AWG)

*Overlap Crimps

Dieless crimp tools must not be used to crimp CPM/CPML adaptors.

See stuffer sheet for complete information on tooling.

Aluminum Pigtail Adaptor

Dual Rated

Conductor Range: 1/0 – #6



A

TYPE
ACMN
ACON

Features

- Manufactured from high strength aluminum alloy
- ACMN pin is center, ACON pin is off center
- Chamfered barrel
- cULus listed for 35KV, 90° C/194° F
- Clearly marked with wire size and die index for nVent ILSCO tools, proper number & location of crimps
- Prefilled with De-Ox
- Color coded end caps inserted in barrel
- Supplied with insulating cover, cULus listed for 600 volts, 90° C/194° F

Benefits

- Provides maximum conductivity and excellent crimping characteristics
- ACON configuration allows connectors to be rotated for parallel applications where spacing does not fit straight pin connectors
- Provides easy conductor insertion
- Ensures reliability for aluminum or copper conductors
- Provides easy identification and tooling recommendation
- Prevents oxides from forming
- Prevents foreign materials from entering the connector prior to usage and color code identifies the proper compression die
- Eliminates taping

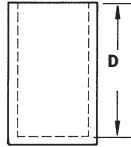
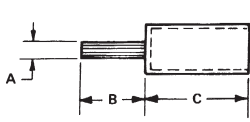

| New Catalog Number | Wire Size | Die Color Code | Pin Size | Dimensions (in.) | | | | O.D. | Cover Part Numbers |
|--------------------|-----------|----------------|----------|------------------|--------------|-----------------|----------------|------|--------------------|
| | | | | A Pin Diameter | B Pin Length | C Barrel Length | D Cover Height | | |
| ACMN-6 | #6 | Tan | #4 | 0.24 | 0.68 | 1.17 | 2.14 | 0.60 | PCC-4 |
| ACMN-4 | #4 | | #4 | 0.24 | 0.68 | | | | |
| ACMN-2 | #2 | | #4 | 0.24 | 0.68 | | | | |
| ACMN-1 | #1 | | #3 | 0.26 | 0.84 | | | | |
| ACMN-1/0 | 1/0 | | #2 | 0.29 | 0.84 | | | | |

Tooling Information

| Catalog Number | nVent ILSCO | | | | Utilco | | | Burndy | | | | Greenlee | Rigid |
|----------------|-----------------------|-----------------------|-----------------------|-----------------------|-------------------------|-----------------------|-----------------------|-----------------------|-----------------------|-----------------------|-----------------------|-----------------------|-----------------------|
| | Die No. No. of Crimps | Die No. No. of Crimps | Die No. No. of Crimps | Die No. No. of Crimps | Die Index No. of Crimps | Die No. No. of Crimps | Die No. No. of Crimps | Die No. No. of Crimps | Die No. No. of Crimps | Die No. No. of Crimps | Die No. No. of Crimps | Die No. No. of Crimps | Die No. No. of Crimps |
| | nVent ILSCO Die | Burndy Die | Dieless | Dieless | nVent ILSCO Die | Burndy Die | Dieless | nVent ILSCO Die | Burndy Die | Dieless | Dieless | nVent ILSCO Die | nVent ILSCO Die |
| ACMN-6 | ILD-296 (1) | U25ART (1) | (1) | (1) | ILD-296 (1) | U25ART (1) | (1) | ILD-296 (1) | U25ART (1) | (1) | (1) | ILD-296 (1) | ILD-296 (1) |
| ACMN-4 | ILD-296 (1) | U25ART (1) | (1) | (1) | ILD-296 (1) | U25ART (1) | (1) | ILD-296 (1) | U25ART (1) | (1) | (1) | ILD-296 (1) | ILD-296 (1) |
| ACMN-2 | ILD-296 (1) | U25ART (1) | (1) | (1) | ILD-296 (1) | U25ART (1) | (1) | ILD-296 (1) | U25ART (1) | (1) | (1) | ILD-296 (1) | ILD-296 (1) |
| ACMN-1 | ILD-296 (1) | U25ART (1) | (1) | (1) | ILD-296 (1) | U25ART (1) | (1) | ILD-296 (1) | U25ART (1) | (1) | (1) | ILD-296 (1) | ILD-296 (1) |
| ACMN-1/0 | ILD-296 (1) | U25ART (1) | (1) | (1) | ILD-296 (1) | U25ART (1) | (1) | ILD-296 (1) | U25ART (1) | (1) | (1) | ILD-296 (1) | ILD-296 (1) |

Tested to UL 486A/B, UL File E62525

All wire sizes, unless noted otherwise, are American Wire Gauge (AWG)

See stuffer sheet for complete information on tooling.

For applications greater than 600 volts, remove cover and use appropriate means of insulation.

Aluminum Pigtail Adaptor

Dual Rated

Conductor Range: 4/0 – 2/0



TYPE
ACMN
ACON

Features

- Manufactured from high strength aluminum alloy
- ACMN pin is center, ACON pin is off center
- Chamfered barrel
- cULus listed for 35KV, 90° C/194° F
- Clearly marked with wire size and die index for nVent ILSCO tools, proper number & location of crimps
- Prefilled with De-Ox
- Color coded end caps inserted in barrel
- Supplied with insulating cover, cULus listed for 600 volts, 90° C/194° F

Benefits

- Provides maximum conductivity and excellent crimping characteristics
- ACON configuration allows connectors to be rotated for parallel applications where spacing does not fit straight pin connectors
- Provides easy conductor insertion
- Ensures reliability for aluminum or copper conductors
- Provides easy identification and tooling recommendation
- Prevents oxides from forming
- Prevents foreign materials from entering the connector prior to usage and color code identifies the proper compression die
- Eliminates taping

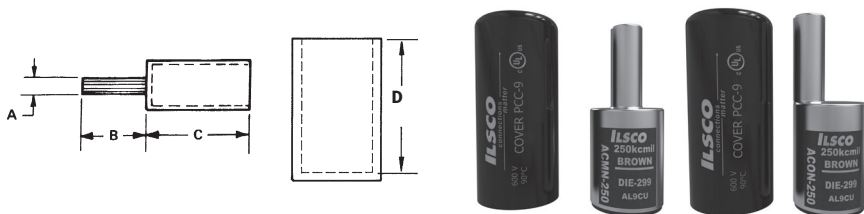

| New Catalog Number | Wire Size | Die Color Code | Pin Size | Dimensions (in.) | | | | O.D. | Cover Part Numbers |
|--------------------|-----------|----------------|----------|------------------|--------------|-----------------|----------------|------|--------------------|
| | | | | A Pin Diameter | B Pin Length | C Barrel Length | D Cover Height | | |
| ACMN-2/0 | 2/0 | White | #1 | 0.33 | 0.84 | 1.37 | 2.48 | 0.85 | PCC-7 |
| ACON-2/0 | 2/0 | | | | 1.13 | 1.57 | | | |
| ACMN-3/0 | 3/0 | | 1/0 | 0.37 | 1.22 | 1.37 | | | |
| ACON-3/0 | 3/0 | | | | 1.25 | 1.55 | | | |
| ACMN-4/0 | 4/0 | | 2/0 | 0.42 | 1.22 | 1.37 | | | |
| ACON-4/0 | 4/0 | | | | 1.28 | 1.52 | | | |

Tooling Information

| Catalog Number | nVent ILSCO | | | | Utilco | | | Burndy | | | | Greenlee | Rigid |
|----------------|-----------------------|-----------------------|-----------------------|-----------------------|-------------------------|-------------------------|-------------------------|-----------------------|-----------------------|-----------------------|-----------------------|-----------------------|-----------------------|
| | Die No. No. of Crimps | Die No. No. of Crimps | Die No. No. of Crimps | Die No. No. of Crimps | Die Index No. of Crimps | Die Index No. of Crimps | Die Index No. of Crimps | Die No. No. of Crimps | Die No. No. of Crimps | Die No. No. of Crimps | Die No. No. of Crimps | Die No. No. of Crimps | Die No. No. of Crimps |
| | nVent ILSCO Die | Burndy Die | Dieless | Dieless | nVent ILSCO Die | Burndy Die | Dieless | nVent ILSCO Die | Burndy Die | Dieless | Dieless | nVent ILSCO Die | nVent ILSCO Die |
| ACMN-2/0 | ILD-298 (2) | U28ART (2) | (1) | (1) | ILD-298 (2) | U28ART (2) | (1) | ILD-298 (2) | U28ART (2) | (1) | (1) | ILD-298 (2) | ILD-298 (2) |
| ACON-2/0 | ILD-298 (2) | U28ART (2) | (1) | (1) | ILD-298 (2) | U28ART (2) | (1) | ILD-298 (2) | U28ART (2) | (1) | (1) | ILD-298 (2) | ILD-298 (2) |
| ACMN-3/0 | ILD-298 (2) | U28ART (2) | (1) | (1) | ILD-298 (2) | U28ART (2) | (1) | ILD-298 (2) | U28ART (2) | (1) | (1) | ILD-298 (2) | ILD-298 (2) |
| ACON-3/0 | ILD-298 (2) | U28ART (2) | (1) | (1) | ILD-298 (2) | U28ART (2) | (1) | ILD-298 (2) | U28ART (2) | (1) | (1) | ILD-298 (2) | ILD-298 (2) |
| ACMN-4/0 | ILD-298 (2) | U28ART (2) | (2) | (1) | ILD-298 (2) | U28ART (2) | (2) | ILD-298 (2) | U28ART (2) | (2) | (1) | ILD-298 (2) | ILD-298 (2) |
| ACON-4/0 | ILD-298 (2) | U28ART (2) | (2) | (1) | ILD-298 (2) | U28ART (2) | (2) | ILD-298 (2) | U28ART (2) | (2) | (1) | ILD-298 (2) | ILD-298 (2) |

Tested to UL 486A/B, UL File E62525

All wire sizes, unless noted otherwise, are American Wire Gauge (AWG)

See stuffer sheet for complete information on tooling.

For applications greater than 600 volts, remove cover and use appropriate means of insulation.

Aluminum Pigtail Adaptor

Dual Rated

Conductor Range: 350kcmil – 250kcmil



A TYPE ACMN ACON

Features

- Manufactured from high strength aluminum alloy
- ACMN pin is center, ACON pin is off center
- Chamfered barrel
- cULus listed for 35KV, 90° C/194° F
- Clearly marked with wire size and die index for nVent ILSCO tools, proper number & location of crimps
- Prefilled with De-Ox
- Color coded end caps inserted in barrel
- Supplied with insulating cover, cULus listed for 600 volts, 90° C/194° F

Benefits

- Provides maximum conductivity and excellent crimping characteristics
- ACON configuration allows connectors to be rotated for parallel applications where spacing does not fit straight pin connectors
- Provides easy conductor insertion
- Ensures reliability for aluminum or copper conductors
- Provides easy identification and tooling recommendation
- Prevents oxides from forming
- Prevents foreign materials from entering the connector prior to usage and color code identifies the proper compression die
- Eliminates taping

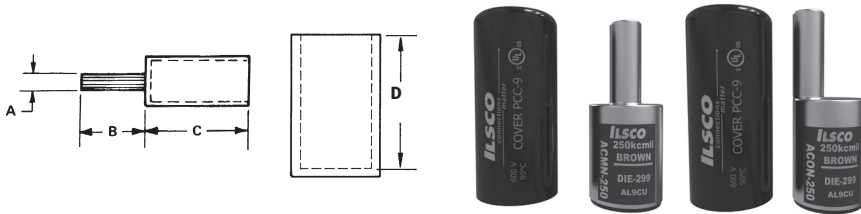

| New Catalog Number | Wire Size | Die Color Code | Pin Size | Dimensions (in.) | | | | O.D. | Cover Part Numbers |
|--------------------|-----------|----------------|----------|------------------|--------------|-----------------|----------------|------|--------------------|
| | | | | A Pin Diameter | B Pin Length | C Barrel Length | D Cover Height | | |
| ACMN-250 | 250kcmil | Brown | 3/0 | 0.47 | 1.22 | 1.41 | 2.73 | 1.1 | PCC-9 |
| ACON-250 | 250kcmil | | | 0.53 | 1.28 | 1.52 | | | |
| ACMN-300 | 300kcmil | | 0.53 | 1.34 | 1.41 | | | | |
| ACON-300 | 300kcmil | | 0.57 | 1.47 | 1.63 | | | | |
| ACMN-350 | 350kcmil | | 0.57 | 1.34 | 1.41 | | | | |
| ACON-350 | 350kcmil | | 0.57 | 1.47 | 1.63 | | | | |

Tooling Information

| Catalog Number | nVent ILSCO | | | | Utilco | | | Burndy | | | | Greenlee | Rigid |
|----------------|-----------------------|------------|-------------------------------------------|--------------------------|--------------------------------|-------------------------|--------------------------------|----------------------------------------------------|--------------------------|----------------------------|-----------------------|-----------------------|-----------------|
| | Die No. No. of Crimps | Burndy Die | TB-6DF1000 Series, TR-6DF1000, TM-6DF1000 | IDT-12, IDTB-12, IDT-12H | UM-U42, UR-U42, BLL-U42 Series | Die Index No. of Crimps | UM-4PT, UR-4PT, BLL-4PT Series | Y35 Series, Y39 Series, Y750 Series, PAT750 Series | Y81 Series, PAT81 Series | Y644 Series, PAT644 Series | Die No. No. of Crimps | Die No. No. of Crimps | |
| | nVent ILSCO Die | Burndy Die | Dieless | Dieless | nVent ILSCO Die | Burndy Die | Dieless | nVent ILSCO Die | Burndy Die | Dieless | Dieless | nVent ILSCO Die | nVent ILSCO Die |
| ACMN-250 | ILD-299 (2) | U31ART (2) | (2) | (1) | ILD-299 (2) | U31ART (2) | (2) | ILD-299 (2) | U31ART (2) | (2) | (1) | ILD-299 (2) | ILD-299 (2) |
| ACON-250 | ILD-299 (2) | U31ART (2) | (2) | (1) | ILD-299 (2) | U31ART (2) | (2) | ILD-299 (2) | U31ART (2) | (2) | (1) | ILD-299 (2) | ILD-299 (2) |
| ACMN-300 | ILD-299 (2) | U31ART (2) | (2) | (1) | ILD-299 (2) | U31ART (2) | (2) | ILD-299 (2) | U31ART (2) | (2) | (1) | ILD-299 (2) | ILD-299 (2) |
| ACON-300 | ILD-299 (2) | U31ART (2) | (2) | (1) | ILD-299 (2) | U31ART (2) | (2) | ILD-299 (2) | U31ART (2) | (2) | (1) | ILD-299 (2) | ILD-299 (2) |
| ACMN-350 | ILD-299 (2) | U31ART (2) | (3) | (1) | ILD-299 (2) | U31ART (2) | (3) | ILD-299 (2) | U31ART (2) | (3) | (1) | ILD-299 (2) | ILD-299 (2) |
| ACON-350 | ILD-299 (2) | U31ART (2) | (3) | (1) | ILD-299 (2) | U31ART (2) | (3) | ILD-299 (2) | U31ART (2) | (3) | (1) | ILD-299 (2) | ILD-299 (2) |

Tested to UL 486A/B, UL File E62525

All wire sizes, unless noted otherwise, are American Wire Gauge (AWG)

See stuffer sheet for complete information on tooling.

For applications greater than 600 volts, remove cover and use appropriate means of insulation.

Aluminum Offset Pigtail Adaptor

Dual Rated

Conductor Range: 750kcmil – 400kcmil



TYPE
ACMN
ACON

Features

- Manufactured from high strength aluminum alloy
- ACMN pin is center, ACON pin is off center
- Chamfered barrel
- cULus listed for 35KV, 90° C/194° F
- Clearly marked with wire size and die index for nVent ILSCO tools, proper number & location of crimps
- Prefilled with De-Ox
- Color coded end caps inserted in barrel
- Supplied with insulating cover, cULus listed for 600 volts, 90° C/194° F

Benefits

- Provides maximum conductivity and excellent crimping characteristics
- ACON configuration allows connectors to be rotated for parallel applications where spacing does not fit straight pin connectors
- Provides easy conductor insertion
- Ensures reliability for aluminum or copper conductors
- Provides easy identification and tooling recommendation
- Prevents oxides from forming
- Prevents foreign materials from entering the connector prior to usage and color code identifies the proper compression die
- Eliminates taping

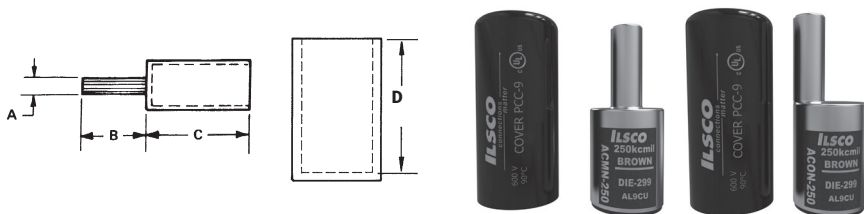

| New Catalog Number | Wire Size | Die Color Code | Pin Size | Dimensions (in.) | | | | O.D. | Cover Part Numbers |
|--------------------|-----------|----------------|----------|------------------|--------------|-----------------|----------------|------|--------------------|
| | | | | A Pin Diameter | B Pin Length | C Barrel Length | D Cover Height | | |
| ACMN-400 | 400kcmil | Pink | 300kcmil | .63 | 1.60 | 1.48 | 3.11 | 1.32 | PCC-11 |
| ACMN-500 | 500kcmil | Pink | 350kcmil | .68 | 1.60 | 1.48 | 3.11 | 1.32 | PCC-11 |
| ACON-500 | | | | | 1.69 | 1.71 | | | |
| ACMN-600 | 600kcmil | Yellow | 400kcmil | .73 | 1.64 | 2.03 | 3.36 | 1.44 | PCC-12 |
| ACON-600 | | | | | 1.73 | 2.27 | | | |
| ACMN-750 | 750kcmil | Yellow | 500kcmil | .81 | 1.76 | 2.03 | 3.36 | 1.44 | PCC-12 |
| ACON-750 | | | | | 1.73 | 2.47 | | | |

Tooling Information

| Catalog Number | nVent ILSCO | | | | Utilco | | | Burdny | | | | Greenlee | Rigid |
|----------------|--------------------------------------------------------------------------------------------------|--------------|---------|---------|--------------------------------|--------------|---------|----------------------------------------------------|--------------|---------|---------|------------------------|-----------------|
| | Die No. No. of Crimps | Burdny Die | Dieless | Dieless | nVent ILSCO Die | Burdny Die | Dieless | nVent ILSCO Die | Burdny Die | Dieless | Dieless | nVent ILSCO Die | nVent ILSCO Die |
| | TB-12U1000 Series, TR-12U1000, TM-12U1000, ILC-750, ILC-14 Series, ILC-12 Series, ILCB-12 Series | | | | UM-U42, UR-U42, BLL-U42 Series | | | Y35 Series, Y39 Series, Y750 Series, PAT750 Series | | | | EK1240, HK1240, RK1240 | RE-12M |
| | | | | | Die Index No. of Crimps | | | | | | | | |
| | | | | | | | | | | | | | |
| ACMN-400 | ILD-300 (2) | U34ART (2) | (3) | (1) | ILD-300 (2) | U34ART (2) | (3) | ILD-300 (2) | U34ART (2) | (3) | (1) | ILD-300 (2) | ILD-300 (2) |
| ACMN-500 | ILD-300 (2) | U34ART (2) | (3) | (1) | ILD-300 (2) | U34ART (2) | (3) | ILD-300 (2) | U34ART (2) | (3) | (1) | ILD-300 (2) | ILD-300 (2) |
| ACON-500 | ILD-300 (2) | U34ART (2) | (3) | (1) | ILD-300 (2) | U34ART (2) | (3) | ILD-300 (2) | U34ART (2) | (3) | (1) | ILD-300 (2) | ILD-300 (2) |
| ACMN-600 | ILD-936 (2) | U39ART-2 (2) | (3) | (1) | ILD-936 (2) | U39ART-2 (2) | (3) | ILD-936 (2) | U39ART-2 (2) | (3) | (1) | ILD-936 (2) | ILD-936 (2) |
| ACON-600 | ILD-936 (2) | U39ART-2 (2) | (3) | (1) | ILD-936 (2) | U39ART-2 (2) | (3) | ILD-936 (2) | U39ART-2 (2) | (3) | (1) | ILD-936 (2) | ILD-936 (2) |
| ACMN-750 | ILD-936 (2) | U39ART-2 (2) | (3) | (1) | ILD-936 (2) | U39ART-2 (2) | (3) | ILD-936 (2) | U39ART-2 (2) | (3) | (1) | ILD-936 (2) | ILD-936 (2) |
| ACON-750 | ILD-936 (2) | U39ART-2 (2) | (3) | (1) | ILD-936 (2) | U39ART-2 (2) | (3) | ILD-936 (2) | U39ART-2 (2) | (3) | (1) | ILD-936 (2) | ILD-936 (2) |

Tested to UL 486A/B, UL File E62525

All wire sizes, unless noted otherwise, are American Wire Gauge (AWG). See stuffer sheet for complete information on tooling. For applications greater than 600 volts, remove cover and use appropriate means of insulation.

Aluminum Compression Lugs

Dual Rated - Narrow Tang

Conductor Range: 600kcmil-4



A

TYPE IACL

Features

- Manufactured from high strength aluminum alloy
- Four OD sizes accommodate a wire range from #4 to 600 kcmil
- Chamfered barrel
- Prefilled with De-Ox
- Color coded end caps inserted in barrel and roll
- marked with die number and number of crimps
- Electro tin plated
- Suitable for use in circuits rated 35KV or less, proper high voltage spacing and insulation techniques must be used
- Rated to 90° C/194° F

Benefits

- Provides maximum conductivity and excellent crimping characteristics
- Requires only four installation dies to crimp eleven conductor sizes. Tang width remains constant within an OD size and is designed to fit transformer pads.
- Provides easy conductor insertion
- Prevents oxides from forming
- Prevents foreign materials from entering the connector prior to usage and color code identifies the proper compression die
- Provides low contact resistance
- Ensures reliability
- Application versatility

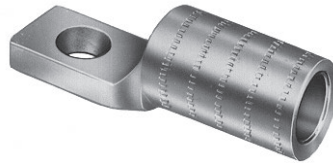
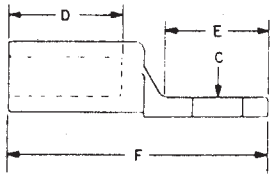

| Catalog Number | Wire Size | Wire Range When Installed With IDT-12-N Tool | Tang Width | Bolt Size | Dimensions (in.) | | | | nVent ILSCO Die Index | Die Color Code |
|----------------|-----------|----------------------------------------------|------------|-----------|------------------|--------|---------|------|-----------------------|----------------|
| | | | | | D | E | F | C | | |
| IACL-4 | 4 | 4-6 | 29/32 | 1/2 | 1-7/16 | 1-3/32 | 3 | 9/16 | 9 | Orange |
| IACL-2 | 2 | 2-6 | 29/32 | 1/2 | 1-7/16 | 1-3/32 | 3 | 9/16 | 9 | Orange |
| IACL-1/0 | 1/0 | 1/0-1 | 29/32 | 1/2 | 1-7/16 | 1-3/32 | 3 | 9/16 | 9 | Orange |
| IACL-2/0 | 2/0 | 2/0-1 | 29/32 | 1/2 | 1-7/16 | 1-9/32 | 3-3/16 | 9/16 | 12 | White |
| IACL-3/0 | 3/0 | 3/0-1 | 29/32 | 1/2 | 1-7/16 | 1-9/32 | 3-3/16 | 9/16 | 12 | White |
| IACL-4/0 | 4/0 | 4/0-1 | 29/32 | 1/2 | 1-7/16 | 1-9/32 | 3-3/16 | 9/16 | 12 | White |
| IACL-250 | 250kcmil | 250kcmil-1/0 | 29/32 | 1/2 | 1-7/16 | 1-9/32 | 3-3/16 | 9/16 | 12 | White |
| IACL-300 | 300kcmil | 300kcmil-2/0 | 1-1/4 | 1/2 | 1-3/4 | 1-5/16 | 3-11/16 | 9/16 | 14 | Blue |
| IACL-350 | 350kcmil | 350kcmil-3/0 | 1-1/4 | 1/2 | 1-3/4 | 1-5/16 | 3-11/16 | 9/16 | 14 | Blue |
| IACL-500 | 500kcmil | 500kcmil-4/0 | 1-1/4 | 1/2 | 1-3/4 | 1-5/16 | 3-11/16 | 9/16 | 14 | Blue |
| IACL-600 | 600kcmil | 600kcmil-250kcmil | 1-19/32 | 1/2 | 3-3/16 | 1-5/8 | 5-3/4 | 9/16 | 18 | Yellow |

Tooling Information

| Catalog Number | Color | nVent ILSCO | | | | | Burdny | | | | | | | | Thomas & Betts | | | | Anderson VC-6 - Ft. Dieless No. of Crimps |
|----------------|--------|-------------|---------------------------|-----------------------|---------|------------------|-----------|------|-----|-----|-----|-----|------|---------------|----------------|----------|-----------|----------|-------------------------------------------|
| | | Die Index | ILC-12-N ILC-12H-N 12 Ton | ILCB-12-N ILCB-12-LIO | ILC-15H | IDT-12-N Dieless | Die Index | Y34A | Y35 | Y39 | Y45 | Y46 | Y48B | Y644M Dieless | Die Index | 13642 12 | TBM 15 15 | 21940 40 | |
| IACL-4 | Orange | 9 | (3) | (3) | (2) | (1) | 297 | (2) | (2) | (2) | (2) | (2) | (2) | (1) | 50 | (2) | (2) | (2) | (2) |
| IACL-2 | Orange | 9 | (3) | (3) | (2) | (1) | 297 | (2) | (2) | (2) | (2) | (2) | (2) | (1) | 50 | (2) | (2) | (2) | (2) |
| IACL-1/0 | Orange | 9 | (3) | (3) | (2) | (1) | 297 | (2) | (2) | (2) | (2) | (2) | (2) | (1) | 50 | (2) | (2) | (2) | (2) |
| IACL-2/0 | White | 12 | (1) | (1) | (2) | (1) | 324 | (2) | (2) | (2) | (2) | (2) | (2) | (1) | 71 | (2) | (2) | (2) | (2) |
| IACL-3/0 | White | 12 | (1) | (1) | (2) | (1) | 324 | (2) | (2) | (2) | (2) | (2) | (2) | (1) | 71 | (2) | (2) | (2) | (2) |
| IACL-4/0 | White | 12 | (1) | (1) | (2) | (1) | 324 | (2) | (2) | (2) | (2) | (2) | (2) | (1) | 71 | (2) | (2) | (2) | (2) |
| IACL-250 | White | 12 | (1) | (1) | (2) | (1) | 324 | (2) | (2) | (2) | (2) | (2) | (2) | (1) | 71 | (2) | (2) | (2) | (2) |
| IACL-300 | Blue | 14 | (2) | (2) | (2) | (1) | 299 | - | (2) | (2) | (2) | (2) | (2) | (1) | 87 | (2) | (2) | (2) | (2) |
| IACL-350 | Blue | 14 | (2) | (2) | (2) | (1) | 299 | - | (2) | (2) | (2) | (2) | (2) | (1) | 87 | (2) | (2) | (2) | (2) |
| IACL-500 | Blue | 14 | (2) | (2) | (2) | (1) | 299 | - | (2) | (2) | (2) | (2) | (2) | (1) | 87 | (2) | (2) | (2) | (2) |
| IACL-600 | Yellow | 18 | (3) | (3) | (3) | (1) | 936 | - | - | (3) | (3) | (3) | (3) | (1) | 115 | (3) | (3) | (3) | - |

Tested to UL 486A/B, UL File E6207

All wire sizes, unless noted otherwise, are American Wire Gauge (AWG)

See stuffer sheet for complete information on tooling.

Aluminum Compression Lugs

Dual Rated - Narrow Tang

Conductor Range: 1000kcmil-1/0



TYPE 2IACL

Features

- Manufactured from high strength aluminum alloy
- Four OD sizes accommodate a wire range from 1/0 to 1000 kcmil
- Chamfered barrel
- Prefilled with De-Ox
- Color coded end caps inserted in barrel and roll
- marked with die number and number of crimps
- Electro tin plated
- Suitable for use in circuits rated 35KV or less, proper high voltage spacing and insulation techniques must be used
- Rated to 90° C/194° F

Benefits

- Provides maximum conductivity and excellent crimping characteristics
- Requires only four installation dies to crimp eleven conductor sizes. Tang width remains constant within an OD size and is designed to fit transformer pads.
- Provides easy conductor insertion
- Prevents oxides from forming
- Prevents foreign materials from entering the connector prior to usage and color code identifies the proper compression die
- Provides low contact resistance
- Ensures reliability
- Application versatility

A

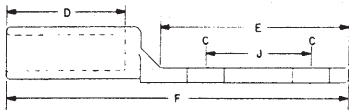

| Catalog Number | Wire Size | Wire Range When Installed With IDT-12-N Tool | Tang Width | Bolt Size | Dimensions (in.) | | | | | nVent ILSCO Die Index | Die Color Code |
|----------------|-----------|----------------------------------------------|------------|-----------|------------------|-------|--------|---------|-------|-----------------------|----------------|
| | | | | | D | E | F | C | J | | |
| 2IACL-1/0 | 1/0 | 1/0-1 | 1 | 1/2 | 1-1/2 | 3-1/4 | 5-3/16 | 9/16(2) | 1-3/4 | 9 | Orange |
| 2IACL-2/0 | 2/0 | 2/0-1 | 1-1/4 | 1/2 | 1-7/8 | 3-1/4 | 5-3/4 | 9/16(2) | 1-3/4 | 12 | White |
| 2IACL-3/0 | 3/0 | 3/0-1 | 1-1/4 | 1/2 | 1-7/8 | 3-1/4 | 5-3/4 | 9/16(2) | 1-3/4 | 12 | White |
| 2IACL-4/0 | 4/0 | 4/0-1 | 1-1/4 | 1/2 | 1-7/8 | 3-1/4 | 5-3/4 | 9/16(2) | 1-3/4 | 12 | White |
| 2IACL-250 | 250kcmil | 250kcmil-1/0 | 1-1/4 | 1/2 | 1-7/8 | 3-1/4 | 5-3/4 | 9/16(2) | 1-3/4 | 12 | White |
| 2IACL-300 | 300kcmil | 300kcmil-2/0 | 1-1/4 | 1/2 | 2-3/8 | 3-1/4 | 6 | 9/16(2) | 1-3/4 | 14 | Blue |
| 2IACL-350 | 350kcmil | 350kcmil-3/0 | 1-1/4 | 1/2 | 2-3/8 | 3-1/4 | 6 | 9/16(2) | 1-3/4 | 14 | Blue |
| 2IACL-500 | 500kcmil | 500kcmil-4/0 | 1-1/4 | 1/2 | 2-3/8 | 3-1/4 | 6 | 9/16(2) | 1-3/4 | 14 | Blue |
| 2IACL-600 | 600kcmil | 600kcmil-250kcmil | 1-39/64 | 1/2 | 3-3/16 | 3-1/4 | 7 | 9/16(2) | 1-3/4 | 18 | Yellow |
| 2IACL-750 | 750kcmil | 750kcmil-500kcmil | 1-39/64 | 1/2 | 3-3/16 | 3-1/4 | 7-1/4 | 9/16(2) | 1-3/4 | 18 | Yellow |
| 2IACL-1000 | 1000kcmil | 1000kcmil-750kcmil | 1-39/64 | 1/2 | 3-3/16 | 3-1/4 | 7-1/4 | 9/16(2) | 1-3/4 | 18 | Yellow |

Tooling Information

| Catalog Number | Color | nVent ILSCO | | | | | Burdyn | | | | | | | | Thomas & Betts | | | | Anderson |
|----------------|--------|-------------|---------------------------|-----------------------|---------|------------------|-----------|------|-----|-----|-----|-----|------|---------------|----------------|----------|-----------|----------|----------------------------------|
| | | Die Index | ILC-12-N ILC-12H-N 12 Ton | ILCB-12-N ILCB-12-L10 | ILC-15H | IDT-12-N Dieless | Die Index | Y34A | Y35 | Y39 | Y45 | Y46 | Y48B | Y644M Dieless | Die Index | 13642 12 | TBM 15 15 | 21940 40 | VC-6 - Ft. Dieless No. of Crimps |
| 2IACL-1/0 | Orange | 9 | (3) | (3) | (2) | (1) | 297 | (2) | (2) | (2) | (2) | (2) | (2) | (1) | 50 | (2) | (2) | (2) | (2) |
| 2IACL-2/0 | White | 12 | (1) | (1) | (2) | (1) | 324 | (2) | (2) | (2) | (2) | (2) | (2) | (1) | 71 | (2) | (2) | (2) | (2) |
| 2IACL-3/0 | White | 12 | (1) | (1) | (2) | (1) | 324 | (2) | (2) | (2) | (2) | (2) | (2) | (1) | 71 | (2) | (2) | (2) | (2) |
| 2IACL-4/0 | White | 12 | (1) | (1) | (2) | (1) | 324 | (2) | (2) | (2) | (2) | (2) | (2) | (1) | 71 | (2) | (2) | (2) | (2) |
| 2IACL-250 | White | 12 | (1) | (1) | (2) | (1) | 324 | (2) | (2) | (2) | (2) | (2) | (2) | (1) | 71 | (2) | (2) | (2) | (2) |
| 2IACL-300 | Blue | 14 | (2) | (2) | (2) | (1) | 299 | - | (2) | (2) | (2) | (2) | (2) | (1) | 87 | (2) | (2) | (2) | (2) |
| 2IACL-350 | Blue | 14 | (2) | (2) | (2) | (1) | 299 | - | (2) | (2) | (2) | (2) | (2) | (1) | 87 | (2) | (2) | (2) | (2) |
| 2IACL-500 | Blue | 14 | (2) | (2) | (2) | (1) | 299 | - | (2) | (2) | (2) | (2) | (2) | (1) | 87 | (2) | (2) | (2) | (2) |
| 2IACL-600 | Yellow | 18 | (3) | (3) | (3) | (1) | 936 | - | - | (3) | (3) | (3) | (3) | (1) | 115 | (3) | (3) | (3) | - |
| 2IACL-750 | Yellow | 18 | (3) | (3) | (3) | (1) | 936 | - | - | (3) | (3) | (3) | (3) | (1) | 115 | (3) | (3) | (3) | - |
| 2IACL-1000 | Yellow | 18 | - | - | (3) | (1) | 936 | - | - | (3) | (3) | (3) | (3) | (1) | 115 | (3) | (3) | (3) | - |

Tested to UL 486A/B, UL File E6207

All wire sizes, unless noted otherwise, are American Wire Gauge (AWG)
See stuffer sheet for complete information on tooling.

Aluminum Compression Sleeves

Utility Type

RoHS
Compliant

A

**TYPE
UCS**

Features

- Manufactured from high strength aluminum alloy, 90° C/194° F
- Four OD sizes accommodate a wire range from 1000kcmil to #4
- Chamfered barrel
- Prefilled with De-Ox
- Solid barrier in center
- Color coded end caps inserted in barrel

Benefits

- Provides maximum conductivity and excellent crimping characteristics
- Requires only four installation dies to crimp fourteen conductor sizes.
- Provides easy conductor insertion
- Prevents oxides from forming
- Prevents dissimilar metals from coming into contact
- Prevents foreign materials from entering the connector prior to usage and color code identifies the proper compression die

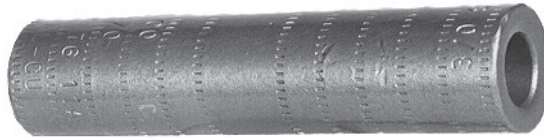

| Catalog Number | Wire Range | Dimensions (in.) | | | Installing Dies | Die Index |
|----------------|---------------------|------------------|---------|--------|-------------------------------|-----------|
| | | L | O.D. | I.D. | | |
| UCS-4-Z | 4 | 3 in | 41/64 | 9/32 | BG, 5/8, 8A | 9 |
| UCS-2-Z | 2 | 3 in | 41/64 | 11/32 | BG, 5/8, 8A | 9 |
| UCS-1/0-Z | 1/0 | 3 in | 41/64 | 27/64 | BG, 5/8, 8A | 9 |
| UCS-2/0-Z | 2/0 | 4 in | 29/32 | 7/16 | 249, 840, TX, 76, 11A | 13 |
| UCS-3/0-Z | 3/0 | 4 in | 29/32 | 1/2 | 249, 840, TX, 76, 11A | 13 |
| UCS-4/0-Z | 4/0 | 4 in | 29/32 | 9/16 | 249, 840, TX, 76, 11A | 13 |
| UCS-250-Z | 250kcmil | 4 in | 29/32 | 19/32 | 249, 840, TX, 76, 11A | 13 |
| UCS-300-Z | 300kcmil | 5 in | 1-5/32 | 21/32 | 299, 655, 705, 1-1/8, 13A | 14 |
| UCS-350-Z | 350kcmil | 5 in | 1-5/32 | 45/64 | 299, 655, 705, 96, 1-1/8, 13A | 14 |
| UCS-500-Z | 500kcmil | 5 in | 1-5/32 | 27/32 | 299, 655, 705, 96, 1-1/8, 13A | 14 |
| UCS-600-Z | 600kcmil | 6 in | 1-39/64 | 59/64 | 301, 1-1/2, 140 | 18 |
| UCS-700/750-Z | 750kcmil - 700kcmil | 6 in | 1-39/64 | 1-1/32 | 301, 1-1/2, 140, 72H | 18 |
| UCS-1000-Z | 1000kcmil | 7 in | 1-39/64 | 1-3/16 | 301, 1-1/2, 140, 72H | 18 |

All wire sizes, unless noted otherwise, are American Wire Gauge (AWG)

Insulated Aluminum Service Entrance Sleeves

TYPE PICS

Features

- Pre-insulated
- Concave polyethylene end caps
- Dual rated
- Meets ANSI C119.4 requirements
- RUS Listed
- Die Index 5/8 or BG

Benefits

- Fast, easy installation
- Seal out dirt but are easily pierced when inserting conductor
- For use with aluminum-aluminum and aluminum-copper conductors
- Ensures reliability

A

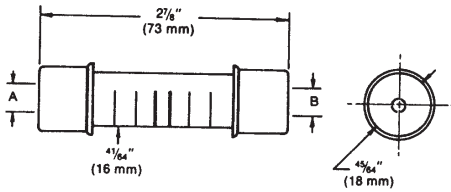

| Catalog Number | End "A" Conductor Range | | | | Color Code | End "A" Conductor Range | | | | Die Color Code |
|----------------|-------------------------|-----------------|----------|-------|------------|-------------------------|-----------------|----------|-------|----------------|
| | ACSR | AWG | Diameter | | | ACSR | AWG | Diameter | | |
| | | | max. | min. | | | | max. | min. | |
| PICS-61 | - | 6 sol - 8 str | 0.162 | 0.144 | Green | - | 6 sol - 8 str | 0.162 | 0.144 | Green |
| PICS-62 | 6 | 4 sol - 6 str | 0.204 | 0.184 | Blue | - | 8 sol - 10 str | 0.128 | 0.114 | Brown |
| PICS-63 | 6 | 4 sol - 6 str | 0.204 | 0.184 | Blue | - | 6 sol - 8 str | 0.162 | 0.144 | Green |
| PICS-64 | 6 | 4 sol - 6 str | 0.204 | 0.184 | Blue | 6 | 4 sol - 6 str | 0.204 | 0.184 | Blue |
| PICS-65 | 4 | 2 sol - 3-4 str | 0.258 | 0.213 | Orange | - | 8 sol - 10 str | 0.128 | 0.114 | Brown |
| PICS-66 | 4 | 2 sol - 3-4 str | 0.258 | 0.213 | Orange | - | 6 sol - 8 str | 0.162 | 0.144 | Green |
| PICS-67 | 4 | 2 sol - 3-4 str | 0.258 | 0.213 | Orange | 6 | 4 sol - 6 str | 0.204 | 0.184 | Blue |
| PICS-68 | 4 | 2 sol - 3-4 str | 0.258 | 0.213 | Orange | 4 | 2 sol - 3-4 str | 0.258 | 0.213 | Orange |
| PICS-70 | 2 | 1-2 str | 0.328 | 0.268 | Red | - | 6 sol - 8 str | 0.162 | 0.144 | Green |
| PICS-71 | 2 | 1-2 str | 0.328 | 0.268 | Red | 6 | 4 sol - 6 str | 0.204 | 0.184 | Blue |
| PICS-72 | 2 | 1-2 str | 0.328 | 0.268 | Red | 4 | 2 sol - 3-4 str | 0.258 | 0.213 | Orange |
| PICS-73 | 2 | 1-2 str | 0.328 | 0.268 | Red | 2 | 1-2 str | 0.328 | 0.268 | Red |
| PICS-75 | 1/0 | 1/0 | 0.398 | 0.368 | Yellow | 6 | 4 sol - 6 str | 0.204 | 0.184 | Blue |
| PICS-76 | 1/0 | 1/0 | 0.398 | 0.368 | Yellow | 4 | 2 sol - 3-4 str | 0.258 | 0.213 | Orange |
| PICS-77 | 1/0 | 1/0 | 0.398 | 0.368 | Yellow | 2 | 2-1 str | 0.328 | 0.268 | Red |
| PICS-78 | 1/0 | 1/0 | 0.398 | 0.368 | Yellow | - | 1/0 | 0.398 | 0.368 | Yellow |

All wire sizes, unless noted otherwise, are American Wire Gauge (AWG)

Insulated Aluminum Service Entrance Sleeves

RoHS
Compliant

A TYPE P840

Features

- Pre-insulated
- Concave polyethylene end caps
- Dual rated
- Meets ANSI C119.4 requirements
- RUS Listed
- Die Index 840

Benefits

- Fast, easy installation
- Seal out dirt but are easily pierced when inserting conductor
- For use with aluminum-aluminum and aluminum-copper conductors
- Ensures reliability

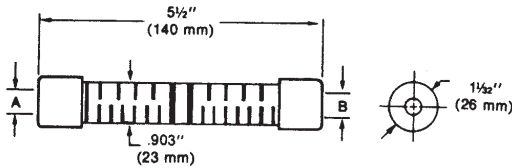

| Catalog Number | End "A" Conductor Range | | | | Color Code | End "A" Conductor Range | | | | Die Color Code |
|----------------|-------------------------|----------------------|----------|-------|------------|-------------------------|----------------------|----------|-------|----------------|
| | ACSR | AWG | Diameter | | | ACSR | AWG | Diameter | | |
| | | | max. | min. | | | | max. | min. | |
| PICS-834 | 1/0 | 2/0 (compact) or 1/0 | 0.398 | 0.365 | Yellow | 4 | 2 sol - 3-4 str | 0.258 | 0.213 | Orange |
| PICS-835 | 1/0 | 2/0 (compact) or 1/0 | 0.398 | 0.365 | Yellow | 2 | 1-2 str | 0.328 | 0.268 | Red |
| PICS-836 | 1/0 | 2/0 (compact) or 1/0 | 0.398 | 0.365 | Yellow | 1/0 | 2/0 (compact) or 1/0 | 0.398 | 0.365 | Yellow |
| PICS-844 | 2/0 | 3/0 (compact) or 2/0 | 0.448 | 0.414 | Gray | 4 | 2 sol - 3-4 str | 0.258 | 0.213 | Orange |
| PICS-845 | 2/0 | 3/0 (compact) or 2/0 | 0.448 | 0.414 | Gray | 2 | 1-2 str | 0.328 | 0.268 | Red |
| PICS-846 | 2/0 | 3/0 (compact) or 2/0 | 0.448 | 0.414 | Gray | 1/0 | 2/0 (compact) or 1/0 | 0.398 | 0.365 | Yellow |
| PICS-847 | 2/0 | 3/0 (compact) or 2/0 | 0.448 | 0.414 | Gray | 2/0 | 3/0 (compact) or 2/0 | 0.448 | 0.414 | Gray |
| PICS-854 | 3/0 | 4/0 (compact) or 3/0 | 0.502 | 0.464 | Black | 4 | 2 sol - 3-4 str | 0.258 | 0.213 | Orange |
| PICS-855 | 3/0 | 4/0 (compact) or 3/0 | 0.502 | 0.464 | Black | 2 | 1-2 str | 0.328 | 0.268 | Red |
| PICS-856 | 3/0 | 4/0 (compact) or 3/0 | 0.502 | 0.464 | Black | 1/0 | 2/0 (compact) or 1/0 | 0.398 | 0.365 | Yellow |
| PICS-857 | 3/0 | 4/0 (compact) or 3/0 | 0.502 | 0.464 | Black | 2/0 | 3/0 (compact) or 2/0 | 0.448 | 0.414 | Gray |
| PICS-858 | 3/0 | 4/0 (compact) or 3/0 | 0.502 | 0.464 | Black | 3/0 | 4/0 (compact) or 3/0 | 0.502 | 0.464 | Black |
| PICS-864 | 4/0 | 4/0 | 0.564 | 0.522 | Pink | 4 | 2 sol - 3-4 str | 0.258 | 0.213 | Orange |
| PICS-865 | 4/0 | 4/0 | 0.564 | 0.522 | Pink | 2 | 1-2 str | 0.328 | 0.268 | Red |
| PICS-866 | 4/0 | 4/0 | 0.564 | 0.522 | Pink | 1/0 | 1/0 | 0.398 | 0.365 | Yellow |
| PICS-867 | 4/0 | 4/0 | 0.564 | 0.522 | Pink | 2/0 | 3/0 (compact) or 2/0 | 0.448 | 0.414 | Gray |
| PICS-868 | 4/0 | 4/0 | 0.564 | 0.522 | Pink | 3/0 | 4/0 (compact) or 3/0 | 0.502 | 0.464 | Black |
| PICS-869 | 4/0 | 4/0 | 0.564 | 0.522 | Pink | 4/0 | 4/0 | 0.564 | 0.522 | Pink |

All wire sizes, unless noted otherwise, are American Wire Gauge (AWG)

Aluminum Compression Tap Connectors

Dual Rated



TYPE
AH

Features

- Prefilled with oxide inhibitor
- Color coded
- Manufactured from high strength aluminum alloy
- UL Listed
- Suitable for use in circuits rated 35KV or less, proper high voltage spacing and insulation techniques must be used
- Rated to 90° C/194° F

Benefits

- Provides corrosion resistance
- Provides visual recommendation for nVent ILSCO or standard industry tools
- Provides maximum conductivity and excellent crimping characteristics
- Ensures reliability for copper or aluminum conductors
- Application versatility

A



| Catalog Number | Wire Range | | nVent ILSCO Compression Tool | Die Index | L | W |
|----------------|-----------------------------------------------------------|---------------------|------------------------------|-----------|------|------|
| | Main | Tap | | | | |
| AH-1 | 1/0 str - 6 str | 1 str - 6 str | ND-58/ND-60 | 0 | 1.62 | 1.78 |
| AH-2 | 4/0 str - 1 str | 1 str - 6 str | ND-58/ND-60 | D3 | 1.88 | 2.31 |
| AH-3 | 4/0 str - 3/0 str | 4/0 str - 3/0 str | ND-58/ND-60 | D3 | 2.50 | 2.50 |
| AH-4 | 4/0 str - 1 str | 2/0 str - 1 str | ND-58/ND-60 | D3 | 2.50 | 2.38 |
| AH-5 | 400kcmil - 4/0 str | 400kcmil - 4/0 str | ILC-15H* | N | 3.50 | 3.09 |
| AH-6 | 500kcmil - 4/0 str | 2/0 str - 6 str | ILC-15H* | N | 2.00 | 2.84 |
| AH-10 | 1000kcmil Compact - 600kcmil AL 750kcmil - 600kcmil CU | 350kcmil - 2/0 str | ILC-15H* | KR | 3.50 | 4.62 |
| AH-11 | 1000kcmil Compact - 600kcmil AL 750kcmil - 600kcmil CU | 600kcmil - 350kcmil | ILC-15H* | KR | 4.62 | 4.75 |

Tested to UL 486A/B, UL File E6207

All wire sizes, unless noted otherwise, are American Wire Gauge (AWG)

*Other hydraulic tools can be used. See stuffer sheet for complete information on tooling.

Aluminum Compression Tap Connectors



A TYPE HT

Features

- Serrated interior
- Prefilled with oxide inhibitor
- Installed with industry standard "O" and "D" dies
- Manufactured from high strength aluminum alloy
- Suitable for use in circuits rated 35KV or less, proper high voltage spacing and insulation techniques must be used
- Rated to 90° C/194° F

Benefits

- Assures positive mating with cable strands when compressed
- Provides corrosion resistance
- Provides convenient die selection
- Provides maximum conductivity and excellent crimping characteristics
- Application versatility

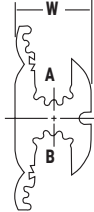
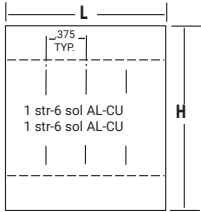

| Catalog Number | Wire Range | | | | | | | | | | Connector Number | Mech. Die | No. of Crimps | | Dimensions (in.) | | | | | | | | | | | | | | | | | | |
|----------------|-----------------|-------------------|---------------------|---------------|------------------|-----------------------|-------------------------|-------------------------|------------------|------------------|------------------|-----------|---------------|------|------------------|-------|---------|----|-------|-------|---------|----|-------|-------|--------|-----|-------|-------|---------|-------|-------|-------|-------|
| | Standard Wire | | | | | | Compact Wire | | | | | | | | | | | | | | | | | | | | | | | | | | |
| | A Groove | | | B Groove | | | A Groove | | B Groove | | | | Hyd. tool | Tool | L | W | H | | | | | | | | | | | | | | | | |
| | ACSR | str | sol | ACSR | str | sol | ACSR | str | ACSR | str | | | | | | | | | | | | | | | | | | | | | | | |
| HT-6 | 2, 3, 4, 6, - | 1, 2, 3, 4, 6, - | 1, 2, 3, 4, 5, 6, - | 2, 3, 4, 6, - | 1, 2, 3, 4, 6, - | 1, 2, 3, 4, 6, - | 1, 2, 3, 4, 6, - | 1, 2, 3, 4, 6, - | 1, 2, 3, 4, 6, - | 1, 2, 3, 4, 6, - | 1 | 0 | 4 | 2 | 1-1/2 | 23/32 | 1-23/32 | | | | | | | | | | | | | | | | |
| | 1/0, 1, 2, 3, - | 2/0, 1/0, 1, 2, - | 3/0, 2/0, 1/0, 1, - | 2, 3, 4, 6, - | 1, 2, 3, 4, 6, - | 1/0, 1, 2, 3, 4, 6, - | 2/0, 1/0, 1, 2, 3, 4, - | 2/0, 1/0, 1, 2, 3, 4, - | 1, 2, 3, 4, 6, - | 1, 2, 3, 4, 6, - | | 2 | 0 | 5 | | | | 2 | 1-1/2 | 45/64 | 1-25/32 | | | | | | | | | | | | |
| | 2/0, 1/0, - | 3/0, 2/0, - | - | 2, 3, 4, 6, - | 1, 2, 3, 4, 6, - | 1/0, 1, 2, 3, 4, 6, - | 3/0, 2/0, - | 3/0, 2/0, - | 1, 2, 3, 4, 6, - | 1, 2, 3, 4, 6, - | | | 3 | D3 | | | | 5 | | | | 2 | 1-7/8 | 13/16 | 2-3/16 | | | | | | | | |
| | 2/0, 1/0, 1 | 3/0, 2/0, 1/0 | - | 2/0, 1/0, 1 | 3/0, 2/0, 1/0 | - | 3/0, 2/0, 1/0 | 3/0, 2/0, 1/0 | 3/0, 2/0, 1/0 | 3/0, 2/0, 1/0 | | | | 4 | | | | D3 | | | | 6 | | | | 2 | 1-7/8 | 57/64 | 2-17/64 | | | | |
| | 4/0, 3/0, - | 4/0, 3/0, - | - | 2, 3, 4, 6, - | 1, 2, 3, 4, 6, - | 1/0, 1, 2, 3, 4, 6, - | 266, 4/0, 3/0 | 266, 250, 4/0 | 1, 2, 3, 4, 6, - | 1, 2, 3, 4, 6, - | | | | | | | | 5 | | | | D3 | | | | 5 | | | | 2 | 1-7/8 | 53/64 | 2-1/4 |
| | 4/0, 3/0, - | 4/0, 3/0, - | - | 2/0, 1/0, - | 2/0, 1/0, - | - | 266, 4/0, 3/0 | 266, 250, 4/0 | 2/0, 1/0, - | 3/0, 2/0, 1/0 | | | | | | | | | | | | 6 | | | | D3 | | | | 7 | | | |
| 4/0, 3/0, - | 4/0, 3/0, - | - | 4/0, 3/0, - | 4/0, 3/0, - | - | 266, 4/0, 3/0 | 266, 250, 4/0 | 266, 4/0, 3/0 | 266, 250, 4/0 | 7 | D3 | | | | 7 | 3 | 2-1/2 | | | | | | | | | 7/8 | | | | 2-1/2 | | | |

All wire sizes, unless noted otherwise, are American Wire Gauge (AWG)
Consult factory for tool and die information.

Information Sheet

Series ALNS, ALND, ASNS, ASND, ALNB, ASNB, ALNN, ASNN, and ASNA

Compression Connectors for Aluminum or Copper Conductor



Tooling Information

| | | ILSCO | | | | | | | | | | | | | | |
|----------------------|----------------------|------------|--------|----------|--------|----------------|--------|----------|----------------|----------|----------------|-----------------------|----------------|----------|--------|----------------|
| Lug/Splice Size | Wire Size | Color Code | Crimps | Die Code | Crimps | Crimps | Crimps | Die Code | Crimps | Die Code | Crimps | Die Code | Crimps | Die Code | Crimps | Crimps |
| 8 | 8 AWG | Blue | 1 | M,K | 2 | 1 | 1 | ILD-374 | 1 | ILD-374 | 1 | ILD-374 | 1 | ILD-374 | 1 | 1 |
| 6 | 6 AWG | Gray | 1 | K,K | 2 | 1 | 1 | ILD-346 | 1 | ILD-346 | 1 | ILD-346 | 1 | ILD-346 | 1 | 1 |
| 4 | 4 AWG | Green | 1 | H,H | 3 | 1 | 1 | ILD-375 | 1 | ILD-375 | 1 | ILD-375 | 1 | ILD-375 | 1 | 1 |
| 2 | 2 AWG | Pink | 2 | E,A | 3 | 1 | 1 | ILD-348 | 1 | ILD-348 | 1 | ILD-348 | 1 | ILD-348 | 2 | 1 ^c |
| 1 | 1 AWG | Gold | 2 | E,A | 3 | 1 | 1 | ILD-471 | 1 | ILD-471 | 1 | ILD-471 | 1 | ILD-471 | 1 | 1 ^c |
| 1/0 | 1/0 AWG | Tan | 2 | A,C | 3 | 1 | 1 | ILD-296 | 1 | ILD-296 | 1 | ILD-296 | 1 | ILD-296 | 2 | 1 ^c |
| 2/0 | 2/0 AWG | Olive | 2 | A,B | 3 | 2 | 1 | ILD-297 | 1 ^c | ILD-297 | 1 ^c | ILD-297 | 1 ^c | ILD-297 | 2 | 2 |
| 3/0 | 3/0 AWG | Ruby | 2 | A,A | 3 | 2 | 1 | ILD-467 | 1 ^c | ILD-467 | 1 ^c | ILD-467 | 1 ^c | ILD-467 | 2 | 2 |
| 4/0 | 4/0 AWG | White | 2 | | | 2 | 1 | ILD-298 | 2 | ILD-298 | 2 | ILD-298 | 2 | ILD-298 | 2 | 2 |
| 250 | 250 kcmil | Red | | | | 2 | 1 | ILD-324 | 2 | ILD-324 | 2 | ILD-324 | 2 | ILD-324 | 2 | 2 |
| 300 | 300 kcmil | Blue | | | | 2 | 1 | ILD-470 | 2 | ILD-470 | 2 | ILD-470 | 2 | ILD-470 | 2 | 2 |
| 350 | 350 kcmil | Brown | | | | 2 | 1 | ILD-299 | 2 | ILD-299 | 2 | ILD-299 | 2 | ILD-299 | 2 | 2 ^d |
| 400 | 400 kcmil | Green | | | | 2 | 1 | ILD-472 | 4 | ILD-472 | 4 | ILD-472 | 4 | ILD-472 | 2 | 2 ^e |
| 500 | 500 kcmil | Pink | | | | 2 ^e | 1 | ILD-300 | 4 | ILD-300 | 4 | ILD-300 | 4 | ILD-300 | 2 | 2 ^e |
| 600 | 600 kcmil | Black | | | | 2 ^e | 1 | ILD-473 | 4 | ILD-473 | 4 | ILD-473 | 4 | ILD-473 | 2 | 2 ^e |
| 700/750 | 700/750 kcmil | Yellow | | | | 2 ^e | 1 | ILD-936 | 3 | ILD-936 | 3 | ILD-936 | 3 | ILD-936 | 2 | 2 ^e |
| 700/750 ⁹ | 900 kcmil Compact Al | Yellow | | | | | | ILD-936 | 3 | ILD-936 | 3 | ILD-936 | 3 | ILD-936 | 3 | |
| 1000 | 1000 kcmil | Brown | | | | | | ILD-936 | 3 | ILD-936 | 3 | ILD-P302 ^h | 3 | | | |

Additional Information:

- The ALNS, ALND, ASNS, ASND, ALNB, ASNB, ALNN, ASNN, and ASN connectors are marked with the die numbers and required number of crimps for ILSCO hydraulic tools. When using other listed tools, consult chart for crimps required. Crimps should be evenly spaced on connector.
- Consult manufacturers data for catalog numbers of dies for each tool.

- Number of crimps shown on chart must be applied to both sides of ASN splice connector's centerline.
 - Dieless tools are not color coded and do not require dies.
 - For ASN splice connector, apply 2 crimps on both sides of splice connector's centerline.
 - For ASN splice connector, apply 3 crimps on both sides of splice connector's centerline.
- For ASN splice connector, apply 4 crimps on both sides of splice connector's centerline.
 - 700/750 size lug/splice are additionally rated for use with 900 kcmil compact aluminum wire.
 - The die index of ILD-P302 is 302.

Connector Installation

- Select proper connector for the wire size to be used. Series can be used with concentric, compressed or compact aluminum or copper wire.
- Strip wire insulation using an approved method. Do not nick or ring the wire. Remove any major coating on the wire.
- Remove surface oxides from the wire with a wire brush.
- Insert wire all the way into the barrel of the connector.
- Select the proper die for approved tool. See chart above for approved tools and dies. Compress barrel from tang toward wire, or from inside of ASN connector towards wire.
- When terminating an aluminum connector to a steel or copper stud, use a Belleville or compression type washer in combination with a flat washer. Tighten the Belleville washer is flat.

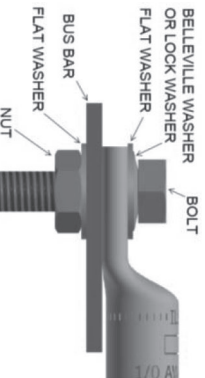

Information Sheet

Series ALNS, ALND, ASNS, ASND, ALNB, ASNB, ALNN, ASNN, and ASNA Compression Connectors for Aluminum or Copper Conductor



Tooling Information

| Lug/Splice Size | Wire Size | Color Code | BURNDY | | | THOMAS AND BETTS | | | GREENLEE | | | ANDERSON | | | RIDGID | | | UTILCO | | |
|----------------------|----------------------|------------|----------|----------------|----------|------------------|-----------------------|----------------|-----------------------|----------------|---------------------|----------|-----------------------|----------------|-----------------------|----------------|---------------------|--------|----------|--------|
| | | | Die Code | Crimps | Die Code | Crimps | Die Code | Crimps | Die Code | Crimps | Die Code | Crimps | Die Code | Crimps | Die Code | Crimps | Die Code | Crimps | Die Code | Crimps |
| 8 | 8 AWG | Blue | X8CART | 1 | URCART | 1 | ILD-374 | 1 | ILD-374 | 1 | VC6-FT ^a | 1 | ILD-374 | 1 | ILD-374 | 1 | UM-4PT ^b | | | |
| 6 | 6 AWG | Gray | W161 | 1 | URCART | 1 | ILD-346 | 1 | ILD-346 | 1 | VC6-FT ^b | 1 | ILD-346 | 1 | ILD-346 | 1 | UR-4PT ^b | | | |
| 4 | 4 AWG | Green | W162 | 2 | U4CART | 1 | ILD-375 | 1 | ILD-375 | 1 | VC6-FT ^b | 1 | ILD-375 | 1 | ILD-375 | 1 | UR-4PT ^b | | | |
| 2 | 2 AWG | Pink | W239 | 2 | U2CART | 1 | ILD-348 | 1 | ILD-348 | 1 | VC7-FT ^a | 1 | ILD-348 | 1 | ILD-348 | 1 | BL-4PT ^b | | | |
| 1 | 1 AWG | Gold | W163 | 2 | U1CART | 1 | ILD-471 | 1 | ILD-471 | 1 | VC7-FT ^b | 1 | ILD-471 | 1 | ILD-471 | 1 | BL-4PT ^b | | | |
| 1/0 | 1/0 AWG | Tan | W241 | 2 | U2CART | 1 | ILD-296 | 1 | ILD-296 | 1 | VC7-FT ^b | 1 | ILD-296 | 1 | ILD-296 | 1 | BL-4PT ^b | | | |
| 2/0 | 2/0 AWG | Olive | W245 | 2 | U2CART | 2 | ILD-297 | 1 ^c | ILD-297 | 1 ^c | VC7-FT ^b | 2 | ILD-297 | 1 ^c | ILD-297 | 1 ^c | BL-4PT ^b | | | |
| 3/0 | 3/0 AWG | Ruby | W166 | 2 | U2CART | 2 | ILD-467 | 1 ^c | ILD-467 | 1 ^c | VC7-FT ^b | 2 | ILD-467 | 1 ^c | ILD-467 | 1 ^c | BL-4PT ^b | | | |
| 4/0 | 4/0 AWG | White | W660 | 2 | U2CART | 2 | ILD-298 | 2 | ILD-298 | 2 | VC7-FT ^b | 2 | ILD-298 | 2 | ILD-298 | 2 | BL-4PT ^b | | | |
| 250 | 250 kcmil | Red | | 2 | U2CART | 2 | ILD-324 | 2 | ILD-324 | 2 | VC7-FT ^b | 2 | ILD-324 | 2 | ILD-324 | 2 | BL-4PT ^b | | | |
| 300 | 300 kcmil | Blue | | 2 | U30ART | 2 | ILD-470 | 2 | ILD-470 | 2 | VC7-FT ^b | 2 | ILD-470 | 2 | ILD-470 | 2 | BL-4PT ^b | | | |
| 350 | 350 kcmil | Brown | W31ART | 3 | U31ART | 2 | ILD-299 | 2 | ILD-299 | 2 | VC7-FT ^b | 2 | ILD-299 | 2 | ILD-299 | 2 | BL-4PT ^b | | | |
| 400 | 400 kcmil | Green | | 2 ^d | U32ART | 4 | ILD-472 | 4 | ILD-472 | 4 | VC7-FT ^b | 2 | ILD-472 | 4 | ILD-472 | 4 | BL-4PT ^b | | | |
| 500 | 500 kcmil | Pink | | 2 ^e | U34ART | 4 | ILD-300 | 4 | ILD-300 | 4 | VC7-FT ^b | 2 | ILD-300 | 4 | ILD-300 | 4 | BL-4PT ^b | | | |
| 600 | 600 kcmil | Black | | 2 ^e | U36ART | 4 | ILD-473 | 4 | ILD-473 | 4 | VC7-FT ^b | 2 | ILD-473 | 4 | ILD-473 | 4 | BL-4PT ^b | | | |
| 700/750 | 700/750 kcmil | Yellow | | 2 ^e | U39ART | 4 | ILD-936 | 3 | ILD-936 | 3 | VC7-FT ^b | 4 | ILD-936 | 3 | ILD-936 | 3 | BL-4PT ^b | | | |
| 700/750 ^h | 900 kcmil compact Al | Yellow | | | | | ILD-936 | 3 | ILD-936 | 3 | VC7-FT ^b | 4 | ILD-936 | 3 | ILD-936 | 3 | BL-4PT ^b | | | |
| 1000 | 1000 kcmil | Brown | | | P44ART | 4 | ILD-P302 ^k | 3 | ILD-P302 ^k | 3 | VC7-FT ^b | 3 | ILD-P302 ^k | 3 | ILD-P302 ^k | 3 | BL-4PT ^b | | | |

Additional Information:

- The ALNS, ALND, ASNS, ASND, ALNB, ASNB, ALNN, ASNN, and ASNA connectors are marked with the die numbers and required number of crimps for ILSCO hydraulic tools. When using other listed tools, consult chart for crimps required. Crimps should be evenly spaced on connector.
- Consult manufacturers data for catalog numbers of dies for each tool.
- Number of crimps shown on chart must be applied to both sides of ASN splice connector's centerline.
- Dieless tools are not color coded and do not require dies.
- For ASN splice connector, apply 2 crimps on both sides of splice connector's centerline.
- For ASN splice connector, apply 3 crimps on both sides of splice connector's centerline.
- For ASN splice connector, apply 4 crimps on both sides of splice connector's centerline.

Connector Installation

- Select proper connector for the wire size to be used. Series can be used with concentric, compressed or compact aluminum or copper wire.
- Strip wire insulation using an approved method. Do not nick or ring the wire. Remove any major coating on the wire.
- Remove surface oxides from the wire with a wire brush.
- Insert wire all the way into the barrel of the connector.
- Select the proper die for approved tool. See chart above for approved tools and dies. Compress barrel from tang toward wire, or from inside of ASN connector towards wire.
- When terminating an aluminum connector to a steel or copper stud, use a Belleville or compression type washer in combination with a flat washer. Tighten until the Belleville washer is flat.

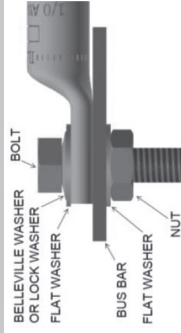

Information Sheet

Series ALNS, ALND, ASNS, ASND, ALNB, ASNB, ALNN, ASNN and ASN^a
Compression Connectors for Aluminum or Copper Conductor



Range Taking (for ILSCO, BURNDY, GREENLEE, RIDGID and UTILCO Dieless Tools)

| Lug/Splice Size | Standard Wire Size | Expanded Wire Range | ILSCO | | BURNDY | | GREENLEE | | RIDGID | | UTILCO | |
|-----------------|--------------------|------------------------|--------------------------|---------------------------|------------------------------------------------------------------------------|-----------------------------|---------------------------------------------------------------------------------------------|------------------------------------------------------------------------------------------------------|---------------------------|--------------------------------------------------------------------------|--------------------------|-------------------------------------------------------------------------------|
| | | | ILSCO MT-25 ^b | ILSCO I/7B-6 ^b | ILSCO IDT-6 ^b , IDT-6H ^b , IDT-B-6 ^b series | ILSCO IDT-12-N ^b | ILSCO TM-6DF-1000 ^b , TR-6DF-1000 ^b , TB-6DF-1000 ^b series | BURNDY PAT4PC334 ^b , PAT81KFT ^b , Y81KFT ^b , Y81KFTMBH ^b | BURNDY Y644M ^b | GREENLEE EK06FT ^b , HK06FT ^b , RK06FT ^b | RIDGID RE 6 ^b | UTILCO UM-4PT ^b , UR-4PT ^b , BL-4PT ^b series |
| 4 | 4 AWG | 4 - 6 AWG | 1 | 1 | 1 | 1 | 1 | 1 | 1 | 1 | 1 | 1 |
| 2 | 2 AWG | 2 - 6 AWG | 2 | 2 | 1 | 1 | 1 ^c | 1 | 2 | 1 | 1 ^c | 1 ^c |
| 1 | 1 AWG | 1 - 2 AWG | 2 | 2 | 1 | 1 | 1 ^c | 1 | 2 | 1 | 1 ^c | 1 ^c |
| 1/0 | 1/0 AWG | 1/0 - 1 AWG | 2 | 2 | 1 | 1 | 1 ^c | 1 | 2 | 1 | 1 ^c | 1 ^c |
| 2/0 | 2/0 AWG | 2/0 - 1 AWG | 2 | 2 | 2 | 1 | 2 | 2 | 2 | 2 | 2 | 2 |
| 3/0 | 3/0 AWG | 3/0 - 1 AWG | 2 | 2 | 2 | 1 | 2 | 2 | 2 | 2 | 2 | 2 |
| 4/0 | 4/0 AWG | 4/0 - 1 AWG | 2 | 2 | 2 | 1 | 2 | 2 | 2 | 2 | 2 | 2 |
| 250 | 250 kcmil | 250 kcmil - 1/0 AWG | 2 | 2 | 2 | 1 | 2 | 2 | 2 | 2 | 2 | 2 |
| 300 | 300 kcmil | 300 kcmil - 2/0 AWG | 2 | 2 | 2 | 1 | 2 | 2 | 2 | 2 | 2 | 2 |
| 350 | 350 kcmil | 350 kcmil - 3/0 AWG | 2 | 2 | 2 | 1 | 2 ^d | 2 | 2 | 2 | 2 | 2 ^d |
| 400 | 400 kcmil | 400 kcmil - 4/0 AWG | 2 | 2 | 2 | 1 | 2 ^e | 2 | 2 | 2 | 2 | 2 ^e |
| 500 | 500 kcmil | 500 kcmil - 4/0 AWG | 2 | 2 | 2 ^e | 1 | 2 ^e | 2 | 2 | 2 | 2 | 2 ^e |
| 600 | 600 kcmil | 600 kcmil - 250 kcmil | 2 | 2 | 2 ^e | 1 | 2 ^e | 2 | 2 | 2 | 2 | 2 ^e |
| 700/750 | 700/750 kcmil | 750 kcmil - 500 kcmil | 2 | 2 | 2 ^e | 1 | 2 ^e | 2 | 2 | 2 | 2 | 2 ^e |
| 1000 | 1000 kcmil | 1000 kcmil - 750 kcmil | 2 | 2 | 2 ^e | 1 | 2 ^e | 2 | 2 | 2 | 2 | 2 ^e |

^a Number of crimps shown on chart must be applied to both sides of ASN splice connector's centerline.

^b Dieless tools are not color coded and do not require dies.

^c For ASN splice connectors, apply 2 crimps on both sides of splice connector's centerline.

^d For ASN splice connectors, apply 3 crimps on both sides of splice connector's centerline.

^e For ASN splice connectors, apply 4 crimps on both sides of splice connector's centerline.

^f ASN-1000 splice connector is NOT UL listed or CSA certified with Y644M dieless tools.

Series CT and CTL

Compression Connectors for Class B/C Copper Wire Only (CU9)

WARNING! Do Not Use With Aluminum Wire

| Lug Size | Color Code | Die Index | ILSCO TOOLS | | | | TAB TOOLS | | | | GREENLEE TOOLS | | | | RIGID TOOLS | | UTILCO TOOLS | | |
|----------|------------|-----------|-------------|-----------|----------|----------|-------------------|-----------------|-----------------|-------------|----------------|-----------------|-----------------|-----------------|-----------------|-----------------|-----------------|-----------------|---|
| | | | Left Die | Right Die | # Crimps | Index # | Manual Hand Tools | Hydraulic Tools | Hydraulic Tools | Manual Tool | Manual Tool | Hydraulic Tools | Hydraulic Tools | Hydraulic Tools | Hydraulic Tools | Hydraulic Tools | Hydraulic Tools | Hydraulic Tools | |
| 8 *** | Red | 21 | M | K | 1 | ILC-10-N | MT-25 | ILC-10-N | Index # | # Crimps | 1 | 1 | 1 | 1 | 1 | 1 | 1 | 1 | 1 |
| 6 *** | Black (D) | 24 (D) | M | K | 2 | 1 | 1 | 1 | 1 | 1 | 1 | 1 | 1 | 1 | 1 | 1 | 1 | 1 | 1 |
| 4 *** | Grey | 29 | M | K | 2 | 1 | 1 | 1 | 1 | 1 | 1 | 1 | 1 | 1 | 1 | 1 | 1 | 1 | 1 |
| 3 *** | White | 33 | H | H | 2 | 1 | 1 | 1 | 1 | 1 | 1 | 1 | 1 | 1 | 1 | 1 | 1 | 1 | 1 |
| 1 ** | Brown | 37 | H | H | 2 | 1 | 1 | 1 | 1 | 1 | 1 | 1 | 1 | 1 | 1 | 1 | 1 | 1 | 1 |
| 1 ** | Green | 42 | E | A | 2 | 1 | 1 | 1 | 1 | 1 | 1 | 1 | 1 | 1 | 1 | 1 | 1 | 1 | 1 |
| 1 ** | Black | 45 | E | A | 3 | 1 | 1 | 1 | 1 | 1 | 1 | 1 | 1 | 1 | 1 | 1 | 1 | 1 | 1 |
| 2/0 ** | Pink | 45 | E | A | 3 | 1 | 1 | 1 | 1 | 1 | 1 | 1 | 1 | 1 | 1 | 1 | 1 | 1 | 1 |
| 2/0 ** | Black | 45 | E | A | 3 | 1 | 1 | 1 | 1 | 1 | 1 | 1 | 1 | 1 | 1 | 1 | 1 | 1 | 1 |
| 4/0 ** | Purple | 54 | A | B | 2 | 1 | 1 | 1 | 1 | 1 | 1 | 1 | 1 | 1 | 1 | 1 | 1 | 1 | 1 |
| 4/0 ** | Yellow | 62 | A | B | 2 | 1 | 1 | 1 | 1 | 1 | 1 | 1 | 1 | 1 | 1 | 1 | 1 | 1 | 1 |
| 250 ** | White | 66 | A | A | 3 | 2 | 2 | 2 | 2 | 2 | 2 | 2 | 2 | 2 | 2 | 2 | 2 | 2 | 2 |
| 350 ** | Red | 71 | | | | 2 | 2 | 2 | 2 | 2 | 2 | 2 | 2 | 2 | 2 | 2 | 2 | 2 | 2 |
| 400 ** | Blue | 76 | | | | 2 | 2 | 2 | 2 | 2 | 2 | 2 | 2 | 2 | 2 | 2 | 2 | 2 | 2 |
| 500 ** | Brown | 87 | | | | 2 | 2 | 2 | 2 | 2 | 2 | 2 | 2 | 2 | 2 | 2 | 2 | 2 | 2 |
| 600 ** | White | 88 | | | | 2 | 2 | 2 | 2 | 2 | 2 | 2 | 2 | 2 | 2 | 2 | 2 | 2 | 2 |
| 650 ** | Green | 84 | | | | 2 | 2 | 2 | 2 | 2 | 2 | 2 | 2 | 2 | 2 | 2 | 2 | 2 | 2 |
| 700 ** | Pink | 99 | | | | 2 | 2 | 2 | 2 | 2 | 2 | 2 | 2 | 2 | 2 | 2 | 2 | 2 | 2 |
| 750 ** | Black | 106 | | | | 2 | 2 | 2 | 2 | 2 | 2 | 2 | 2 | 2 | 2 | 2 | 2 | 2 | 2 |
| 1000 | White | 125 | | | | 2 | 2 | 2 | 2 | 2 | 2 | 2 | 2 | 2 | 2 | 2 | 2 | 2 | 2 |

** See note f below
 † See note k below

RANGE TAKING

| Lug Size | Standard Wire Size | Expanded Wire Size | No. Crimps for ILSCO ID-1-12, ID-1-2N | No. Crimps for ILSCO IDTB-6, IDTB-6-LIO, IDTB-6 and IDTB-6-LIO | No. Crimps for ILSCO IDTB-6, IDTB-6-LIO, IVTB-6 and IVTB-6-LIO | No. Crimps for ILSCO TM-6DF-1000, TR-6DF-1000, TB-6DF-1000 Series | No. Crimps for UTILCO UM-4PT, UR-4PT, BL-4PT Series | No. Crimps for Greenlee HK08FT, RK08FT, EK08FT Series |
|----------|--------------------|------------------------|---------------------------------------|----------------------------------------------------------------|----------------------------------------------------------------|-------------------------------------------------------------------|-----------------------------------------------------|-------------------------------------------------------|
| 4 | 3 AWG | 4 - 6 AWG | 1 | 1 | 1 | 1 | 1 | 1 |
| 3 | 3 AWG | 3 - 6 AWG | 1 | 1 | 1 | 1 | 1 | 1 |
| 2 | 2 AWG | 2 - 6 AWG | 1 | 1 | 1 | 1 | 1 | 1 |
| 1 | 1 AWG | 1 - 6 AWG | 1 | 1 | 1 | 1 | 1 | 1 |
| 1/0 | 1/0 AWG | 1/0 - 6 AWG | 1 | 1 | 1 | 1 | 1 | 1 |
| 2/0 | 2/0 AWG | 2/0 - 4 AWG | 1 | 1 | 1 | 1 | 1 | 1 |
| 3/0 | 3/0 AWG | 3/0 - 4 AWG | 1 | 1 | 1 | 1 | 1 | 1 |
| 4/0 | 4/0 AWG | 4/0 - 1 AWG | 1 | 1 | 1 | 1 | 1 | 1 |
| 250 | 250 kcmil | 250 kcmil - 1/0 AWG | 1 | 2 | 1 | 2 | 2 | 2 |
| 300 | 300 kcmil | 300 kcmil - 2/0 AWG | 1 | 2 | 1 | 2 | 2 | 2 |
| 350 | 350 kcmil | 350 kcmil - 3/0 AWG | 1 | 2 | 2 | 2 | 2 | 2 |
| 400 | 400 kcmil | 400 kcmil - 4/0 AWG | 1 | 2 | 2 | 2 | 2 | 2 |
| 500 | 500 kcmil | 500 kcmil - 250 kcmil | 1 | 2 | 2 | 2 | 2 | 2 |
| 700 | 700 kcmil | 700 kcmil - 550 kcmil | 1 | 2 | 2 | 2 | 2 | 2 |
| 900 | 900 kcmil | 900 kcmil - 650 kcmil | 1 | 3 | 2 | 3 | 3 | 3 |
| 750 | 750 kcmil | 750 kcmil - 500 kcmil | 1 | 3 | 2 | 3 | 3 | 3 |
| 1000 | 1000 kcmil | 1000 kcmil - 750 kcmil | 1 | 3 | 2 | 3 | 3 | 3 |

- UL Listed and CSA Certified when installed with tools and dies shown above
- a) Number of crimps shown on chart must be on each end of the CT splice connectors.
 b) The CT connectors are marked with color, the die numbers and required number of crimps for ILSCO hydraulic tools. When using other listed tools, consult chart for crimps required. Crimps should be evenly spaced on connector.
 c) The ILSCO 94285, MT-25 and all dieless tools are not color coded or do not contain the die index.
 d) Strip Length = Bar Length - Die Index # x 1/16" (for 1/16" crimping die).
 e) Strip Length = Bar Length - Die Index # x 1/16" (for 1/16" crimping die).
 f) UL Complementary Listed under category KDER and CSA Certified for Grounding & Bonding Applications, suitable for direct burial
 g) For long barrel (CTL) connectors add one additional crimp to each side of barrel
 h) For #4 Compact Copper wire, 2 crimps are required for standard barrel connectors. (See note (g) above for long barrel (CTL) connectors.)
 i) Rated for stranded or solid wire
 j) For solid wire only use table below:
- | Lug Size | Index # | # Crimps |
|----------|---------|----------|
| 4 | Blue | 2 |
| 2 | Blue | 2 |
| 2 | Brown | 2 |
- n) Stranded wire only
 o) CT, CTL series #6 splice is also UL listed and CSA certified when crimped with red die (die index 21) using ILSCO ILC-12 series, ILC-18H, ILC-30H or Rigid RE-12-M crimp tools.

Information Sheet

Series CS, CL Compression Connectors for Class B/C Copper Wire Only (CU9)



A

Features

Benefits

| Lug Size | Standard Wire Size (AWG) | Expanded Wire Range (AWG) | nVent ILSCO | | KST | | Burdny | | | | | | T&B | | | | Panduit | |
|----------|--------------------------|---------------------------|---------------------------|--------|----------------|--------|----------|--------|------------|--------|----------|--------|------------------|--------|-------------------------|--------|----------|--------|
| | | | ILST-22K with Die "D1322" | | KST20000D-1322 | | Y8MRB-1 | | MRE-1022B* | | MR-20 | | ERG2002, ERG4002 | | BAT22-6 with die "2002" | | CT-1570 | |
| | | | Die Nest | Crimps | Die Nest | Crimps | Die Nest | Crimps | Die Nest | Crimps | Die Nest | Crimps | Die Nest | Crimps | Die Nest | Crimps | Die Nest | Crimps |
| 10 | 10 Sol/Str | 10-14 Str 10-14 Sol | 12-10 | 1 | 12-10 | 1 | 10 | 1 | 12-10 | 1 | 12-10 | 1 | C | 1 | C | 1 | 12-10 | 1 |

* Expanded Wire Range using Burndy MRE1022B is 10-12 Sol/Str

Additional Information

1. UL Listed to Category ZMVV and complimentary listed to category KDER when installed with the above listed tools
2. Recommended Strip Length = Barrel Length + 1/16 inch

Compression Dies for Aluminum Connectors



Features

Benefits

**Compressor Dies For ILC-12-N, ILC-12H-N, ILCB-12 Series (Hydraulic Tools)
TB-12U1000-P, TM-12U1000, TR-12U1000**

A

| Catalog Number | Die Color Code | Connector Series ALNS, ALND, ALNN Wire Size |
|----------------|----------------|---------------------------------------------|
| ILD-374 | Blue | #8 |
| ILD-346 | Gray | #6 |
| ILD-375 | Green | #4 |
| ILD-348 | Pink | #2 |
| ILD-471 | Gold | #1 |
| ILD-296 | Tan | 1/0 |
| ILD-297 | Olive | 2/0 |
| ILD-467 | Ruby | 3/0 |
| ILD-298 | White | 4/0 |
| ILD-324 | Red | 250kcmil |
| ILD-470 | Blue | 300kcmil |
| ILD-299 | Brown | 350kcmil |
| ILD-472 | Green | 400kcmil |
| ILD-300 | Pink | 500kcmil |
| ILD-473 | Black | 600kcmil |
| ILD-936 | Yellow | 700/750kcmil |



**Compressor Dies For ILC-12, ILC-12-N, ILC-12H, ILC-12H-N, ILCB-12, ILCB-12-N, ILCB-12-LIO, ILC-14,
ILC-14H, ILC-15, ILC-15H, ILC-750, TB-12U1000-P, TM-12U1000, TR-12U1000**

| Catalog Number | Class B/C Copper Wire Only | Fine Strand Copper Wire Only |
|----------------|-----------------------------|------------------------------|
| | Series CS, CL, CT, CTL, F2C | Series CS, CL, CT, CTL, F2C |
| ILD-21 | 8 AWG | 8 FLEX CLASS G,H,I,K,M,DLO |
| ILD-24-1 | 6 AWG, 5 AWG | 6 FLEX CLASS G,H,I,K,M,DLO |
| ILD-29-1 | 4-3 AWG | 4 FLEX CLASS G,H,I,K,M,DLO |
| ILD-33 | 2 AWG | - |
| ILD-37 | 1 AWG | 2 FLEX CLASS G,H,I,K,M,DLO |
| ILD-42 | 1/0 AWG | 1 FLEX CLASS G,H,I,K,M,DLO |
| ILD-45 | 2/0 AWG | 1/0 FLEX CLASS G,H,I,K,M,DLO |
| ILD-50 | 3/0 AWG | 2/0 FLEX CLASS G,H,I,K,M,DLO |
| ILD-54 | 4/0 AWG | 3/0 FLEX CLASS G,H,I,K,M,DLO |
| ILD-62 | 250kcmil | 4/0 FLEX CLASS G,H,I,K,M,DLO |
| ILD-66 | 300kcmil | 250 G,H |
| ILD-71 | 350kcmil | 250 I,K,M, 262 DLO |
| ILD-76 | 400kcmil | 300 G,H,I,K,M, 313 DLO |
| ILD-87 | 500kcmil | 350 G,H,I,K,M, 373 DLO |
| ILD-94 | 600kcmil | 400 G,H,I,K,M, 444 DLO |
| ILD-99 | 700kcmil | 500 G,H,I,K,M, 535 DLO |
| ILD-106 | 750kcmil | 600 G,H,I,M, 646 DLO |
| ILD-125 | 1000kcmil | 750 G,H,I, 777 DLO |

A



Features

Benefits

Compressor Dies For ILC-12-N, ILC-12H-N, ILCB-12-N, ILC-15H, ILC-12, ILC-12H, ILC-14, ILC-14H, ILCB-12, ILCB-12-LIO, ILC-15, ILC-750, TB-12U1000-P, TM-12U1000, TR-12U1000

| Catalog Number | Wire Size | | |
|----------------|---------------------------------------|------------------------------|------------------------------|
| | Legacy Aluminum Terminals and Splices | ACM and ACO Pin Connectors | CPM Pin Connectors |
| ILD-2 | 8 | | |
| ILD-3 | 6 | | |
| ILD-4 | 4 | | |
| ILD-5 | | | |
| ILD-6 | | | |
| ILD-7 | 2, 1 | | |
| ILD-8 | 1/0 | 6, 4, 2, 1 | |
| ILD-9 | 6, 4, 2, 1 | | |
| ILD-10 | 2/0, 3/0 | | |
| ILD-11 | | | |
| ILD-12 | 4/0 | 1/0, 2/0, 3/0, 4/0 | 1/0, 2/0, 3/0, 4/0 |
| ILD-13 | 250kcmil | | |
| ILD-14 | 300kcmil, 350kcmil | 250kcmil, 300kcmil, 350kcmil | 250kcmil, 300kcmil, 350kcmil |
| ILD-15 | | | |
| ILD-16 | 400kcmil | | |
| ILD-16A | *500kcmil | 400kcmil, 500kcmil | 400kcmil, 500kcmil |
| ILD-17 | *600kcmil, *700kcmil | | |
| ILD-18 | *700kcmil | 600kcmil, 750kcmil | 600 kcmil, 750kcmil |
| ILD-P302+ | ‡1000kcmil | | |

* Cannot be used on Sleeves with ILC-12-N, ILC-12H-N, ILC-12 and ILC-12H tools

‡ For use on ALNN-1000-12-134

† For use with ILC-15 or ILC-15H, must be used with ILDPADP when using ILC-15H

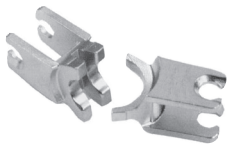

Type W Dies For ND-60, ND-58, TB-6WBG500-I, TB-6W0500-I, TB-6WD3500-I

| Catalog Number | For Use With... | |
|----------------|------------------------------------------------------------|------------------------------------------------------------------------------------|
| | Aluminum Compression Connectors | Copper Compression Connectors |
| ND-O | HT-1, HT-2, AH-1 | GGC-1 (nVent ERICO), GGA-1 (nVent ERICO), GGA-2 (nVent ERICO), GGA-4 (nVent ERICO) |
| ND-BG | PICS-61 thru PICS-78 | ULT-4, ULT-5 |
| ND-C | | ULT-6, ULT-7 |
| ND-K-840 | UCS-2/0, UCS-3/0, UCS-4/0, UCS-250, PICS-834 thru PICS-869 | - |
| ILD-37 | 1 AWG | 2 FLEX CLASS G,H,I,K,M,DLO |
| ILD-42 | 1/0 AWG | 1 FLEX CLASS G,H,I,K,M,DLO |

FOR TYPE
ILC-15
ILC-15H
ILC-750



Figure 1

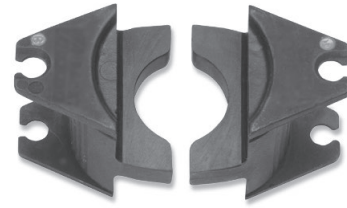

Figure 2

| Catalog Number | Figure Number | For Use With... | |
|----------------|---------------|---------------------------------------------------------------|------------------------------------------------------------------------------------------------------------------------------------------------|
| | | Aluminum Compression Connectors | Copper Compression Connectors |
| ILD-K-840** | 1 | UCS-2/0, UCS-3/0, UCS-4/0, UCS-250, PICS-834 through PICS-869 | |
| ILD-C** | 1 | | ULT-6-Z, ULT-7-Z, ELT-1 (all nVent ERICO) |
| ILD-D3** | 1 | HT-2, HT-3, HT-4, HT-5, HT-7, AH-2, AH-3, AH-4 | ULT-10-Z, ULT-11-Z, ULT-12-Z, CDT-308-8, CDT-307-8 (all nVent ERICO) |
| ILD-O* | 1 | HT-1, HT-6, HT-8, AH-1 | GGC-1, GGA-1, GGA-2, GGA-4, ELT-2, ELT-4, CDT-304-8, CDT-303-8, ULT-8-Z, ULT-9-Z (all nVent ERICO) |
| ILD-N** | 1 | AH-5, AH-6, AH-7 | |
| ILD-KR+ | 2 | AH-8, AH-9, AH-10, AH-11, AH-12 | AH-10, AH-11, AH-12 |
| ILD-997** | 1 | | GGA-2, GGA-3, GGA-4, GGA-5, GGC-2, GGC-3, GGC-4, ELT-3, ELT-5, CGP2-2250, CGP4-2250 (all nVent ERICO); GGA-9 |
| ILD-998+ | 1 | | GGA-4, GGA-5, GGC-5, GGC-6, GGC-7, GGC-9, CGP4-250500, RLT-4TN, RLT-7TN, RLT-2 through RLT-13 (all nVent ERICO); CGP2-250500, RLT-8TN, RLT-9TN |
| ILD-P998° | 2 | Can only be used with ILC-15 or ILC-15H | GGA-4, GGA-5, GGB-1 thru GGB-8, GGC-5, GGC-6, GGC-7 (all nVent ERICO); RLT |
| ILD-P999° | 2 | Can only be used with ILC-15 or ILC-15H | GGA-6, GGC-8 (all nVent ERICO) |
| ILD-1011+ | 1 | | GGA-6, GGC-8, ELT-6, ELT-7, ELT-8, RLT-4TN, RLT-7TN, RLT-2 through RLT-13 (all nVent ERICO); RLT-8TN, RLT-9TN |
| ILD-P1011° | 2 | Can only be used with ILC-15 or ILC-15H | GGA-6, GGC-8 (all nVent ERICO); RLT |
| ILD-BG | 1 | PICS-61 thru PICS-78 | ULT-3-Z, ULT-4-Z, ULT-5-Z, CST-301 (nVent ERICO), CST-302 (nVent ERICO), CDT-399-8 (nVent ERICO), CDT-398-8 (nVent ERICO) |
| ILD-P302o | 1 | ALNN, Can only be used with ILC-15 or ILC-15H | |
| ILD-238 | - | | ULT-1-Z (nVent ERICO) |
| ILD-162 | - | | ULT-2-Z (nVent ERICO) |
| ILD-Prerimp | - | | 1/2, 5/8, 3/4, Ground Rod Pre Crimp Die |

* May also be used with ILC-12-N, ILC-12H-N, ILCB-12-N, ILC-12, ILC-12H, ILCB-12

+ Must be used with ILC-15H when using ILC-15, must be used with ILC-15H when using ILC-15H

° Must be used with ILC-15H when using ILC-15H

Die Adaptors

FOR TYPE
ILC-15
ILC-15H



Figure 1



Figure 2

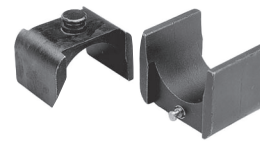

Figure 3



Figure 4

| Catalog Number | Figure Number | Description | Die Color Code |
|----------------|---------------|-------------------------------------------------------------------------------------------------------------|----------------|
| ILD-ADP | 1 | Permits ILC Series to be inserted in ILC-15 or ILC-15H tool, if using ILC-15H ILC-PADP must be used as well | #8 |
| ILD-UADP | 2 | Permits ILC Series to be inserted in ILC-15 or ILC-15H tool | #6 |
| ILD-PADP | 3 | Permits "P" style dies to be inserted in ILC-15H tool | #4 |
| ILD-P302 | 4 | 1000kcmil, ILC-PADP die adaptor must be used | Brown |

ILSCONS

| | | | | | |
|-------------------------------------------------------------------------------------------------------------------------------------------|-------------------------------------------------------------------------------------------------------------------------------------------------------------|----------------------------------------------------------------------------------------------------------------------------------------------------------|----------------------------------------------------------------------------------------------------------------------------------------------------------------------|---------------------------------------------------------------------------------------------------------------------------------------------|----------------------------------------------------------------------------------------------------------------------------------------------------------------------|
| Insulated Ring Terminals  86 | Spades/Forks Flanged Forks  87 | Splices, Disconnects, Bullets  88 | Crimp 'N Seal Kits  89 | Ring Terminals Non-Insulated  90 -93 | Ring Terminals Vinyl Insulated  94 - 95 |
| Ring Terminals Nylon Insulated  96 | High Temperature Ring Terminals Non-Insulated  97 | Ring Terminals Nylon Insulated Heavy Duty Double Crimp  98 | Ring Terminals Multi Stud  99 | Spade Terminals Non-Insulated  100 | Spade Terminals Vinyl Insulated  101 |
| Spade Terminals Nylon Insulated  102 | Spade Terminals Nylon Insulated Heavy Duty Double Crimp  103 | Locking Spade Terminals Non-Insulated  104 | Locking Spade Terminals Nylon Insulated  105 | Locking Spade Terminals Vinyl Insulated  106 | Locking Spade Terminals Nylon Insulated Heavy Duty Double Crimp  107 |
| Flanged Spade Terminals Non-Insulated  108 | Flanged Spade Terminals Nylon Insulated  109 | Flanged Spade Terminals Vinyl Insulated  110 | Flanged Spade Terminals Nylon Insulated Heavy Duty Double Crimp  111 | Fork Terminals Non-Insulated  112 | Fork Terminals Nylon Insulated  113 |
| Fork Terminals Vinyl Insulated  114 | Fork Terminals Nylon Insulated Heavy Duty Double Crimp  115 | Disconnect Terminals Standard Female  116 | Disconnect Terminals Standard Male  117 | Disconnect Terminals Fully Insulated  118 | Disconnect Terminals Fully Insulated, Flag  119 |
| Disconnect Terminals Bullet  120 | Pin Terminals Insulated  121 | Splices Non-Insulated  122 | Splices Vinyl Insulated  123 | Splices Insulated  124 | |
| | | Cool Seal Splices Sealed; Insulated  125 | Crimping Tools 94130  126 | Crimping Tools 94145  126 | |

nVent ILSCO Crimp 'N Seal Watertight Connectors - Heat Shrinkable Insulated Ring Terminals

RoHS
Compliant

UL
LISTED
8M24



TYPE
CNS

Features

- Dual wall tubing
- Color coded
- Manufactured from high strength copper alloy
- Electro-tin plated
- Silver solder brazed seam
- UL Listed and CSA Certified for 600 volts, 90° C/194° F
- Serrated barrel
- Packaged in convenient small quantities

Benefits

- Irradiated, thermally stabilized, high density polyolefin has inner wall of hot melt adhesive to insure watertight seal
- Provides easy wire range identification. #22-18 AWG Red, #16-14 AWG Blue, #12-10 AWG Yellow
- Provides maximum conductivity
- Provides low contact resistance
- May be crimped anywhere and will not split open, even under extreme operating stresses
- Ensures reliability for copper conductor
- "V" grooves inside barrel securely grip wire and prevent pullout
- Can be displayed on merchandise racks

A1

Insulated Ring Terminals



| Catalog Number | Wire Range | Stud Size | Maximum Wire Insulation |
|----------------|------------|-----------|-------------------------|
| 31112-B10 | 18-22 | 6 | .170 |
| 31113-B10 | 18-22 | 8 | .170 |
| 31114-B10 | 18-22 | 10 | .170 |
| 31115-B10 | 18-22 | 1/4 in | .170 |
| 31312-B10 | 14-16 | 6 | .190 |
| 31313-B10 | 14-16 | 8 | .190 |
| 31314-B10 | 14-16 | 10 | .190 |
| 31315-B10 | 14-16 | 1/4 in | .190 |
| 31316-B10 | 14-16 | 5/16 in | .190 |
| 31317-B10 | 14-16 | 3/8 in | .190 |
| 31413-B10 | 10-12 | 8 | .240 |
| 31414-B10 | 10-12 | 10 | .240 |
| 31415-B10 | 10-12 | 1/4 in | .240 |
| 31417-B10 | 10-12 | 3/8 in | .240 |
| 31419-B10 | 10-12 | 1/2 in | .240 |
| 31514-B5 | 8 | 10 | .310 |
| 31515-B5 | 8 | 1/4 in | .310 |
| 31517-B5 | 8 | 3/8 in | .310 |
| 31519-B5 | 8 | 1/2 in | .310 |

All wire sizes, unless noted otherwise, are American Wire Gauge (AWG)

Can be supplied in bulk. Consult factory for part number.

UL File E158587

Crimp 'N Seal

Watertight Connectors - Heat Shrinkable

Spades/Forks, Flanged Forks

RoHS
Compliant

UL
LISTED
8M24



TYPE
CNS

A1

Features

- Dual wall tubing
- Color coded
- Manufactured from high strength copper alloy
- Electro-tin plated
- Silver solder brazed seam
- UL Listed and CSA Certified for 600 volts, 90° C/194° F
- Serrated barrel
- Packaged in convenient small quantities

Benefits

- Irradiated, thermally stabilized, high density polyolefin has inner wall of hot melt adhesive to insure watertight seal
- Provides easy wire range identification. #22-18 AWG Red, #16-14 AWG Blue, #12-10 AWG Yellow
- Provides maximum conductivity
- Provides low contact resistance
- May be crimped anywhere and will not split open, even under extreme operating stresses
- Ensures reliability for copper conductor
- "V" grooves inside barrel securely grip wire and prevent pullout
- Can be displayed on merchandise racks

Spades/Forks



| Catalog Number | Wire Range | Stud Size | Maximum Wire Insulation |
|----------------|------------|-----------|-------------------------|
| 31122-B10 | 18-22 | 6 | .170 |
| 31123-B10 | 18-22 | 8 | .170 |
| 31124-B10 | 18-22 | 10 | .170 |
| 31322-B10 | 14-16 | 6 | .190 |
| 31323-B10 | 14-16 | 8 | .190 |
| 31324-B10 | 14-16 | 10 | .190 |
| 31422-B10 | 10-12 | 6 | .240 |
| 31423-B10 | 10-12 | 8 | .240 |
| 31424-B10 | 10-12 | 10 | .240 |

Flanged Forks



| Catalog Number | Wire Range | Stud Size | Maximum Wire Insulation |
|----------------|------------|-----------|-------------------------|
| 31122FL-B10 | 18-22 | 6 | .170 |
| 31123FL-B10 | 18-22 | 8 | .170 |
| 31124FL-B10 | 18-22 | 10 | .170 |
| 31322FL-B10 | 14-16 | 6 | .190 |
| 31323FL-B10 | 14-16 | 8 | .190 |
| 31324FL-B10 | 14-16 | 10 | .190 |
| 31422FL-B10 | 10-12 | 6 | .240 |
| 31423FL-B10 | 10-12 | 8 | .240 |
| 31424FL-B10 | 10-12 | 10 | .240 |

Crimp 'N Seal

Watertight Connectors - Heat Shrinkable Splices, Disconnects, Bullets

RoHS
Compliant

UL
LISTED
8M24



TYPE CNS

Features

- Dual wall tubing
- Color coded
- Manufactured from high strength copper alloy
- Electro-tin plated
- Silver solder brazed seam
- UL Listed and CSA Certified for 600 volts, 90° C/194° F
- Serrated barrel
- Packaged in convenient small quantities

Benefits

- Irradiated, thermally stabilized, high density polyolefin has inner wall of hot melt adhesive to insure watertight seal
- Provides easy wire range identification. #22-18 AWG Red, #16-14 AWG Blue, #12-10 AWG Yellow
- Provides maximum conductivity
- Provides low contact resistance
- May be crimped anywhere and will not split open, even under extreme operating stresses
- Ensures reliability for copper conductor
- "V" grooves inside barrel securely grip wire and prevent pullout
- Can be displayed on merchandise racks

A1

Butt Splices



| Catalog Number | Wire Range | Maximum Wire Insulation |
|----------------|------------|-------------------------|
| 31130-B10 | 18-22 | .170 |
| 31330-B10 | 14-16 | .190 |
| 31430-B10 | 10-12 | .240 |
| 31530-B5 | 8 | .310 |

Quick Disconnects



| Catalog Number | Wire Range | Tab Size | Style | Maximum Wire Insulation |
|----------------|------------|-------------|--------|-------------------------|
| 30185-B10 | 18-22 | .187 x .020 | Male | .170 |
| 30195-B10 | 18-22 | .187 x .020 | Female | .170 |
| 30187-B10 | 18-22 | .250 x .032 | Male | .170 |
| 30197-B10 | 18-22 | .250 x .032 | Female | .170 |
| 30385-B10 | 14-16 | .187 x .020 | Male | .190 |
| 30395-B10 | 14-16 | .187 x .020 | Female | .190 |
| 30387-B10 | 14-16 | .250 x .032 | Male | .190 |
| 30397-B10 | 14-16 | .250 x .032 | Female | .190 |
| 30487-B10 | 10-12 | .250 x .032 | Male | .240 |
| 30497-B10 | 10-12 | .250 x .032 | Female | .240 |

Bullets/Receptacles



| Catalog Number | Wire Range | Style | Maximum Wire Insulation |
|----------------|------------|--------|-------------------------|
| 31369-B10 | 14-16 | Male | .190 |
| 30379-B10 | 14-16 | Female | .190 |

KITS

Crimp 'N Seal

TYPE

ILSCONS

A1

Features

Crimp 'N Seal heat shrink connector kits provide a convenient and durable assortment of our most popular terminals.



Crimp 'N Seal Splice Kit

Catalog Number 99102 Polyolefin Crimp 'N Seal

A handy kit that includes our high quality ratchet crimp tool and our three most popular splices.

Kit Includes:

| | | | |
|----|-----------------------|----|------------------------------|
| 15 | 22-18 CNS Butt Splice | 15 | 12-10 CNS Butt Splice |
| 15 | 16-14 CNS Butt Splice | 1 | 94130 CNS Ratchet Crimp Tool |



Crimp 'N Seal Terminal Kit

Catalog Number 99300 Polyolefin Crimp 'N Seal

A versatile kit with everything you need to cut, crimp, heat and seal your connection.

Kit Includes:

| | | | |
|----|------------------------------|----|------------------------------------|
| 15 | 22-18 CNS Butt Splice | 20 | 16-14 1/4 in Stud Ring Terminal |
| 15 | 16-14 CNS Butt Splice | 10 | 16-14 Fully Insulated Male Disc. |
| 15 | 12-10 CNS Butt Splice | 10 | 16-14 Fully Insulated Female Disc. |
| 20 | 22-18 #10 Stud Ring Terminal | 1 | 94145 Multi-Purpose Crimp Tool |
| 20 | 16-14 #10 Stud Ring Terminal | 1 | 94700 Shrink Jet Butane Heat Tool |
| 20 | 12-10 #10 Stud Ring Terminal | | |

Ring Terminals

Standard; Non-Insulated



TYPE ILSCONS

Features

- Ring tongue
- Manufactured from high strength copper alloy
- Electro-tin plated
- Funnel wire entry
- Brazed barrel
- UL Listed

Benefits

- Secure termination that cannot be removed unless the mounting screw is removed
- Offers maximum conductivity
- Provides low contact resistance
- Smooth wire insertion into barrel
- Stronger crimp connection that will not split open, prevents wire pull out
- Ensures reliability for copper conductor

A1

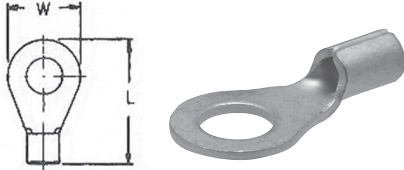

| Catalog Number | Wire Range | Stud Size | Dimensions - in. (mm) | | Installation Tool ILST-22K | Package Quantity |
|-----------------|------------|-----------|-----------------------|--------------|-------------------------------|---------------------|
| | | | L | W | | |
| BRBR-18-6-P50 | 18-22 | 6 | 0.622 (15.8) | 0.315 (8.0) | Die Set D1322 | 50 |
| BRBR-18-8-P50 | 18-22 | 8 | 0.622 (15.8) | 0.315 (8.0) | Die Set D1322 | 50 |
| BRBR-18-10-P50 | 18-22 | 10 | 0.622 (15.8) | 0.315 (8.0) | Die Set D1322 | 50 |
| BRBR-18-14-P50 | 18-22 | 1/4 | 0.858 (21.8) | 0.457 (11.6) | Die Set D1322 | 50 |
| BRBR-18-516-P50 | 18-22 | 5/16 | 0.858 (21.8) | 0.457 (11.6) | Die Set D1322 | 50 |
| BRBR-18-38-P25 | 18-22 | 3/8 | 1.004 (25.5) | 0.535 (13.6) | Die Set D1322 | 25 |
| BRBR-14-6-P50 | 14-16 | 6 | 0.504 (12.8) | 0.260 (6.6) | Die Set D1322 | 50 |
| BRBR-14-8-P50 | 14-16 | 8 | 0.650 (16.5) | 0.335 (8.5) | Die Set D1322 | 50 |
| BRBR-14-10-P50 | 14-16 | 10 | 0.650 (16.5) | 0.335 (8.5) | Die Set D1322 | 50 |
| BRBR-14-14-P50 | 14-16 | 1/4 | 0.858 (21.8) | 0.472 (12.0) | Die Set D1322 | 50 |
| BRBR-14-516-P50 | 14-16 | 5/16 | 0.858 (21.8) | 0.472 (12.0) | Die Set D1322 | 50 |
| BRBR-14-38-P25 | 14-16 | 3/8 | 1.004 (25.5) | 0.535 (13.6) | Die Set D1322 | 25 |
| BRBR-14-12-P50 | 14-16 | 1/2 | 1.197 (30.4) | 0.756 (19.2) | Die Set D1322 | 50 |
| BRBR-10-6-P50 | 10-12 | 6 | 0.748 (19.0) | 0.374 (9.5) | Die Set D1322 | 50 |
| BRBR-10-8-P50 | 10-12 | 8 | 0.748 (19.0) | 0.374 (9.5) | Die Set D1322 | 50 |
| BRBR-10-10-P50 | 10-12 | 10 | 0.748 (19.0) | 0.374 (9.5) | Die Set D1322 | 50 |
| BRBR-10-14-P50 | 10-12 | 1/4 | 0.886 (22.5) | 0.472 (12.0) | Die Set D1322 | 50 |
| BRBR-10-516-P50 | 10-12 | 5/16 | 1.063 (27.0) | 0.591 (15.0) | Die Set D1322 | 50 |
| BRBR-10-38-P25 | 10-12 | 3/8 | 1.063 (27.0) | 0.591 (15.0) | Die Set D1322 | 25 |
| BRBR-10-12-P25 | 10-12 | 1/2 | 1.244 (31.6) | 0.756 (19.2) | Die Set D1322 | 25 |

All wire sizes, unless noted otherwise, are American Wire Gauge (AWG)
Tested to UL 486A/B, UL File E6207

Ring Terminals

Non-Insulated

RoHS
Compliant

UL
LISTED
8M24



TYPE ILSCONS

A1

Features

- Manufactured from high strength copper alloy
- Electro-tin plated
- Silver solder brazed seam

Benefits

- Provides maximum conductivity
- Provides low contact resistance
- May be crimped anywhere and will not split open, even under extreme operating stresses

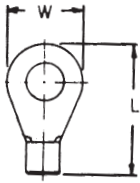

| Catalog Number | Wire Range | Stud Size | Dimensions (in.) | |
|----------------|------------|-----------|------------------|-----|
| | | | L | W |
| 44130-B10 | 8 | 10 | 1.20 | .59 |
| 44131-B10 | 8 | 1/4 | 1.20 | .59 |
| 44140-B10 | 6 | 10 | 1.18 | .47 |
| 44141-B10 | 6 | 1/4 | 1.18 | .47 |
| 44142-B10 | 6 | 5/16 | 1.26 | .63 |
| 44143-B10 | 6 | 3/8 | 1.26 | .63 |

All wire sizes, unless noted otherwise, are American Wire Gauge (AWG)

Can be supplied in bulk. Consult factory for part number. UL File E158587

Ring Terminals

Non-Insulated

RoHS
Compliant

UL
LISTED
8M24



TYPE ILSCONS

Features

- Manufactured from high strength copper alloy
- Electro-tin plated
- Silver solder brazed seam

Benefits

- Provides maximum conductivity
- Provides low contact resistance
- May be crimped anywhere and will not split open, even under extreme operating stresses

A1

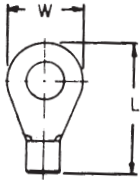

| Catalog Number | Wire Range | Stud Size | Dimensions (in.) | |
|----------------|------------|-----------|------------------|-----|
| | | | L | W |
| 44150-B10 | 4 | 10 | 1.30 | .66 |
| 44151-B10 | 4 | 1/4 | 1.30 | .66 |
| 44152-B10 | 4 | 5/16 | 1.30 | .66 |
| 44153-B10 | 4 | 3/8 | 1.30 | .66 |
| 44154-B10 | 4 | 7/16 | 1.30 | .66 |
| 44155-B10 | 4 | 1/2 | 1.90 | .88 |
| 44160-B10 | 2 | 10 | 1.55 | .60 |
| 44161-B10 | 2 | 1/4 | 1.55 | .60 |
| 44162-B10 | 2 | 5/16 | 1.55 | .70 |
| 44163-B10 | 2 | 3/8 | 1.55 | .70 |
| 44164-B10 | 2 | 7/16 | 1.55 | .81 |
| 44165-B10 | 2 | 1/2 | 1.93 | .81 |
| 44170-B2 | 1/0 | 1/4 | 1.93 | .88 |
| 44171-B2 | 1/0 | 5/16 | 1.93 | .88 |
| 44172-B2 | 1/0 | 3/8 | 1.93 | .88 |
| 44173-B2 | 1/0 | 7/16 | 1.93 | .88 |
| 44174-B2 | 1/0 | 1/2 | 1.93 | .88 |

All wire sizes, unless noted otherwise, are American Wire Gauge (AWG)
Can be supplied in bulk. Consult factory for part number. UL File E158587

Ring Terminals

Non-Insulated

RoHS
Compliant

UL
LISTED
8M24



TYPE ILSCONS

A1

Features

- Manufactured from high strength copper alloy
- Electro-tin plated
- Silver solder brazed seam

Benefits

- Provides maximum conductivity
- Provides low contact resistance
- May be crimped anywhere and will not split open, even under extreme operating stresses

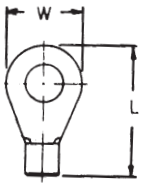

| Catalog Number | Wire Range | Stud Size | Dimensions (in.) | |
|----------------|------------|-----------|------------------|------|
| | | | L | W |
| 44180-B2 | 2/0 | 1/4 | 1.93 | .88 |
| 44181-B2 | 2/0 | 5/16 | 1.93 | .88 |
| 44182-B2 | 2/0 | 3/8 | 1.93 | .88 |
| 44183-B2 | 2/0 | 7/16 | 1.93 | .88 |
| 44184-B2 | 2/0 | 1/2 | 1.93 | .88 |
| 44190-B2 | 3/0 | 1/4 | 1.97 | .93 |
| 44191-B2 | 3/0 | 5/16 | 1.97 | .93 |
| 44192-B2 | 3/0 | 3/8 | 1.97 | .93 |
| 44193-B2 | 3/0 | 7/16 | 1.97 | .93 |
| 44194-B2 | 3/0 | 1/2 | 1.97 | .93 |
| 44195-B2 | 4/0 | 5/16 | 2.17 | 1.08 |
| 44196-B2 | 4/0 | 3/8 | 2.17 | 1.08 |
| 44197-B2 | 4/0 | 7/16 | 2.17 | 1.08 |
| 44198-B2 | 4/0 | 1/2 | 2.17 | 1.08 |

All wire sizes, unless noted otherwise, are American Wire Gauge (AWG)
Can be supplied in bulk. Consult factory for part number.

UL File E158587

Ring Terminals

Standard; Vinyl Insulated



TYPE ILSCONS

Features

- Ring tongue
- Funnel wire entry
- Vinyl insulation
- Color coded
- Manufactured from high strength copper alloy
- Electro-tin plated
- Brazed barrel
- UL Listed for 600 volts, 105° C / 221° F

Benefits

- Secure termination that cannot be removed unless the mounting screw is removed
- Smooth wire insertion into barrel
- Provides corrosion resistance and strain relief
- Provide easy wire range identification
- #18-22 AWG Red, #14-16 AWG Blue, #10-12 AWG Yellow
- Offers maximum conductivity
- Provides low contact resistance
- Stronger crimp connection that will not split open, prevents wire pull out
- Ensures reliability for copper conductor

A1

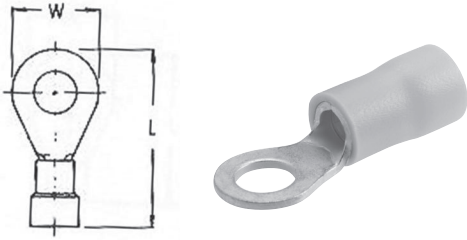

| Catalog Number | Wire Range | Stud Size | Dimensions - in. (mm) | | Installation Tool ILST-22K | Package Quantity |
|-----------------|------------|-----------|-----------------------|--------------|-------------------------------|------------------|
| | | | L | W | | |
| VRBR-18-4-P50 | 18-22 | 4 | 0.689 (17.5) | 0.217 (5.5) | Die Set A | 50 |
| VRBR-18-6-P50 | 18-22 | 6 | 0.819 (20.8) | 0.315 (8.0) | Die Set A | 50 |
| VRBR-18-8-P50 | 18-22 | 8 | 0.819 (20.8) | 0.315 (8.0) | Die Set A | 50 |
| VRBR-18-10-P50 | 18-22 | 10 | 1.055 (26.8) | 0.457 (11.6) | Die Set A | 50 |
| VRBR-18-14-P50 | 18-22 | 1/4 | 1.055 (26.8) | 0.457 (11.6) | Die Set A | 50 |
| VRBR-18-516-P50 | 18-22 | 5/16 | 1.055 (26.8) | 0.457 (11.6) | Die Set A | 50 |
| VRBR-18-38-P25 | 18-22 | 3/8 | 1.201 (30.5) | 0.535 (13.6) | Die Set A | 25 |
| VRBR-14-6-P50 | 14-16 | 6 | 0.858 (21.8) | 0.335 (8.5) | Die Set A | 50 |
| VRBR-14-8-P50 | 14-16 | 8 | 0.858 (21.8) | 0.335 (8.5) | Die Set A | 50 |
| VRBR-14-10-P50 | 14-16 | 10 | 0.858 (21.8) | 0.335 (8.5) | Die Set A | 50 |
| VRBR-14-14-P50 | 14-16 | 1/4 | 1.055 (26.8) | 0.472 (12.0) | Die Set A | 50 |
| VRBR-14-516-P50 | 14-16 | 5/16 | 1.055 (26.8) | 0.472 (12.0) | Die Set A | 50 |
| VRBR-14-38-P25 | 14-16 | 3/8 | 1.201 (30.5) | 0.535 (13.6) | Die Set A | 25 |
| VRBR-14-12-P25 | 14-16 | 1/2 | 1.394 (35.4) | 0.756 (19.2) | Die Set A | 25 |
| VRBR-10-6-P25 | 10-12 | 6 | 0.894 (22.7) | 0.283 (7.2) | Die Set A | 25 |
| VRBR-10-8-P25 | 10-12 | 8 | 1.024 (26.0) | 0.374 (9.5) | Die Set A | 25 |
| VRBR-10-10-P25 | 10-12 | 10 | 1.024 (26.0) | 0.374 (9.5) | Die Set A | 25 |
| VRBR-10-14-P25 | 10-12 | 1/4 | 1.161 (29.5) | 0.472 (12.0) | Die Set A | 25 |
| VRBR-10-516-P25 | 10-12 | 5/16 | 1.339 (34.0) | 0.591 (15.0) | Die Set A | 25 |
| VRBR-10-38-P25 | 10-12 | 3/8 | 1.339 (34.0) | 0.591 (15.0) | Die Set A | 25 |
| VRBR-10-12-P25 | 10-12 | 1/2 | 1.520 (38.6) | 0.756 (19.2) | Die Set A | 25 |

All wire sizes, unless noted otherwise, are American Wire Gauge (AWG)
Tested to UL 486A/B, UL File E6207

Ring Terminals

Vinyl Insulated

RoHS
Compliant

UL
LISTED
8M24



TYPE ILSCONS

A1

Features

- Color coded
- Manufactured from high strength copper alloy
- Electro-tin plated
- Vinyl insulation

Benefits

- Provides easy wire range identification
- #22-18 AWG Red, #16-14 AWG Blue, #12-10 AWG Yellow
- Provides maximum conductivity
- Provides low contact resistance
- Provides tough pliable insulative qualities to protect connectors and wire from corrosion as well as providing some strain relief

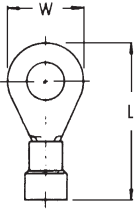

| Catalog Number | Wire Range | Stud Size | Dimensions (in.) | | Maximum Wire Insulated Diameter |
|----------------|------------|-----------|------------------|-----|---------------------------------|
| | | | L | W | |
| 44230-B5 | 8 | 10 | 1.28 | .47 | .385 |
| 44231-B5 | 8 | 1/4 | 1.28 | .47 | .385 |
| 44240-B5 | 6 | 10 | 1.62 | .47 | .440 |
| 44241-B5 | 6 | 1/4 | 1.62 | .47 | .440 |
| 44242-B5 | 6 | 5/16 | 1.70 | .63 | .440 |
| 44243-B5 | 6 | 3/8 | 1.70 | .63 | .440 |
| 44250-B5 | 4 | 10 | 1.81 | .66 | .515 |
| 44251-B5 | 4 | 1/4 | 1.81 | .66 | .515 |
| 44252-B5 | 4 | 5/16 | 1.81 | .66 | .515 |
| 44253-B5 | 4 | 3/8 | 1.81 | .66 | .515 |
| 44254-B5 | 4 | 7/16 | 1.81 | .66 | .515 |
| 44255-B5 | 4 | 1/2 | 2.41 | .88 | .515 |

All wire sizes, unless noted otherwise, are American Wire Gauge (AWG)

* Nylon Insulated Ring Can be supplied in bulk. Consult factory for part number. UL File E158587

Ring Terminals

Standard; Nylon Insulated



TYPE ILSCONS

Features

- Ring tongue
- Funnel wire entry
- Nylon insulation
- Color coded
- Manufactured from high strength copper alloy
- Electro-tin plated
- Brazed barrel
- UL Listed for 600 volts, 105° C/221° F

Benefits

- Secure termination that cannot be removed unless the mounting screw is removed
- Smooth wire insertion into barrel
- Increased heat and chemical resistant qualities for more demanding applications
- Provide easy wire range identification
- #18-22 AWG Red, #14-16 AWG Blue, #10-12 AWG Yellow
- Offers maximum conductivity
- Provides low contact resistance
- Stronger crimp connection that will not split open, prevents wire pull out
- Ensures reliability for copper conductor

A1

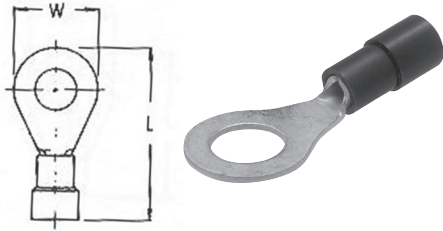

| Catalog Number | Wire Range | Stud Size | Dimensions - in. (mm) | | Installation Tool ILST-22K | Package Quantity |
|-----------------|------------|-----------|-----------------------|--------------|-------------------------------|---------------------|
| | | | L | W | | |
| NRBR-18-6-P50 | 18-22 | 6 | 0.858 (21.8) | 0.315 (8.0) | Die Set A | 50 |
| NRBR-18-8-P50 | 18-22 | 8 | 0.858 (21.8) | 0.315 (8.0) | Die Set A | 50 |
| NRBR-18-10-P50 | 18-22 | 10 | 1.094 (27.8) | 0.457 (11.6) | Die Set A | 50 |
| NRBR-18-14-P50 | 18-22 | 1/4 | 1.094 (27.8) | 0.457 (11.6) | Die Set A | 50 |
| NRBR-18-516-P50 | 18-22 | 5/16 | 1.094 (27.8) | 0.457 (11.6) | Die Set A | 50 |
| NRBR-18-38-P25 | 18-22 | 3/8 | 1.240 (31.5) | 0.535 (13.6) | Die Set A | 25 |
| NRBR-14-6-P50 | 14-16 | 6 | 0.898 (22.8) | 0.335 (8.5) | Die Set A | 50 |
| NRBR-14-8-P50 | 14-16 | 8 | 0.898 (22.8) | 0.355 (9.0) | Die Set A | 50 |
| NRBR-14-10-P50 | 14-16 | 10 | 0.898 (22.8) | 0.355 (9.0) | Die Set A | 50 |
| NRBR-14-14-P50 | 14-16 | 1/4 | 1.094 (27.8) | 0.472 (12.0) | Die Set A | 50 |
| NRBR-14-516-P50 | 14-16 | 5/16 | 1.094 (27.8) | 0.472 (12.0) | Die Set A | 50 |
| NRBR-14-38-P25 | 14-16 | 3/8 | 1.240 (31.5) | 0.535 (13.6) | Die Set A | 25 |
| NRBR-14-12-P25 | 14-16 | 1/2 | 1.433 (36.4) | 0.512 (13.0) | Die Set A | 25 |
| NRBR-10-6-P25 | 10-12 | 6 | 0.894 (22.7) | 0.283 (7.2) | Die Set A | 25 |
| NRBR-10-8-P25 | 10-12 | 8 | 1.024 (26.0) | 0.374 (9.5) | Die Set A | 25 |
| NRBR-10-10-P25 | 10-12 | 10 | 1.024 (26.0) | 0.374 (9.5) | Die Set A | 25 |
| NRBR-10-14-P25 | 10-12 | 1/4 | 1.161 (29.5) | 0.472 (12.0) | Die Set A | 25 |
| NRBR-10-516-P25 | 10-12 | 5/16 | 1.339 (34.0) | 0.591 (15.0) | Die Set A | 25 |
| NRBR-10-38-P25 | 10-12 | 3/8 | 1.339 (34.0) | 0.591 (15.0) | Die Set A | 25 |
| NRBR-10-12-P20 | 10-12 | 1/2 | 1.520 (38.6) | 0.756 (19.2) | Die Set A | 20 |

All wire sizes, unless noted otherwise, are American Wire Gauge (AWG)
Tested to UL 486A/B, UL File E6207

High Temperature Non-Insulated Ring Terminals

RoHS
Compliant



TYPE ILSCONS

A1

Features

- Manufactured from high strength steel alloy
- Electro-tin plated
- Silver solder brazed seam
- 900° F 482° C Continuous, 1200° F 649° C Intermittent

Benefits

- Provides maximum conductivity
- Provides low contact resistance
- May be crimped anywhere and will not split open, even under extreme operating stresses

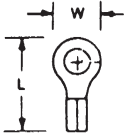

| Catalog Number | Wire Range | Stud Size | Dimensions (in.) | |
|----------------|------------|-----------|------------------|-----|
| | | | L | W |
| 44300-B20 | 18-22 | 4-6 | .65 | .25 |
| 44301-B20 | 18-22 | 8-10 | .69 | .31 |
| 44302-B20 | 18-22 | 12-1/4 | .93 | .56 |
| 44310-B20 | 14-16 | 4-6 | .65 | .25 |
| 44311-B20 | 14-16 | 8-10 | .69 | .31 |
| 44312-B20 | 14-16 | 12-1/4 | .90 | .46 |
| 44320-B20 | 10-12 | 4-6 | .67 | .28 |
| 44321-B20 | 10-12 | 8-10 | .72 | .37 |
| 44322-B20 | 10-12 | 12-1/4 | .93 | .53 |
| 44323-B20 | 10-12 | 5/16-3/8 | .99 | .60 |
| 44330-B10 | 8 | 12-1/4 | .95 | .47 |
| 44340-B10 | 6 | 5/16-3/8 | 1.22 | .63 |

All wire sizes, unless noted otherwise, are American Wire Gauge (AWG)
Can be supplied in bulk. Consult factory for part number.

Ring Terminals

Nylon Insulated Heavy Duty Double Crimp



TYPE ILSCONS

Features

- Ring tongue
- Barrel allows for two crimps
- Funnel wire entry
- Nylon insulation
- Color coded
- Manufactured from high strength copper alloy
- Electro-tin plated
- Brazed barrel
- UL Listed for 600 volts, 105° C/221° F

Benefits

- Secure termination that cannot be removed unless the mounting screw is removed
- Provides strain relief, prevents exposure of wire conductors
- Smooth wire insertion into barrel
- Increased heat and chemical resistant qualities for more demanding applications
- Provide easy wire range identification
- #18-22 AWG Red, #14-16 AWG Blue, #10-12 AWG Yellow
- Offers maximum conductivity
- Provides low contact resistance
- Stronger crimp connection that will not split open, prevents wire pull out
- Ensures reliability for copper conductor

A1

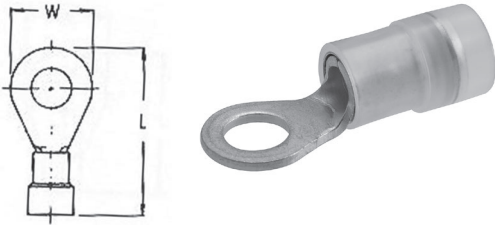

| Catalog Number | Wire Range | Stud Size | Dimensions - in. (mm) | | Installation Tool ILST-22K | Package Quantity |
|------------------|------------|-----------|-----------------------|--------------|-------------------------------|---------------------|
| | | | L | W | | |
| NRBRD-18-6-P50 | 18-22 | 6 | 0.858 (21.8) | 0.315 (8.0) | Die Set B | 50 |
| NRBRD-18-8-P50 | 18-22 | 8 | 0.858 (21.8) | 0.315 (8.0) | Die Set B | 50 |
| NRBRD-18-10-P50 | 18-22 | 10 | 1.094 (27.8) | 0.457 (11.6) | Die Set B | 50 |
| NRBRD-18-14-P50 | 18-22 | 1/4 | 1.094 (27.8) | 0.457 (11.6) | Die Set B | 50 |
| NRBRD-18-516-P50 | 18-22 | 5/16 | 1.094 (27.8) | 0.457 (11.6) | Die Set B | 50 |
| NRBRD-18-38-P50 | 18-22 | 3/8 | 1.240 (31.5) | 0.535 (13.6) | Die Set B | 50 |
| NRBRD-14-6-P50 | 14-16 | 6 | 0.898 (22.8) | 0.335 (8.5) | Die Set B | 50 |
| NRBRD-14-8-P50 | 14-16 | 8 | 0.898 (22.8) | 0.335 (8.5) | Die Set B | 50 |
| NRBRD-14-10-P50 | 14-16 | 10 | 0.898 (22.8) | 0.335 (8.5) | Die Set B | 50 |
| NRBRD-14-14-P50 | 14-16 | 1/4 | 1.094 (27.8) | 0.472 (12.0) | Die Set B | 50 |
| NRBRD-14-516-P50 | 14-16 | 5/16 | 1.094 (27.8) | 0.472 (12.0) | Die Set B | 50 |
| NRBRD-14-38-P50 | 14-16 | 3/8 | 1.240 (31.5) | 0.535 (13.6) | Die Set B | 50 |
| NRBRD-14-12-P50 | 14-16 | 1/2 | 1.433 (36.4) | 0.756 (19.2) | Die Set B | 50 |
| NRBRD-10-6-P25 | 10-12 | 6 | 0.894 (22.7) | 0.283 (7.2) | Die Set B | 25 |
| NRBRD-10-8-P25 | 10-12 | 8 | 1.024 (26.0) | 0.374 (9.5) | Die Set B | 25 |
| NRBRD-10-10-P25 | 10-12 | 10 | 1.024 (26.0) | 0.374 (9.5) | Die Set B | 25 |
| NRBRD-10-14-P25 | 10-12 | 1/4 | 1.161 (29.5) | 0.472 (12.0) | Die Set B | 25 |
| NRBRD-10-516-P25 | 10-12 | 5/16 | 1.339 (34.0) | 0.591 (15.0) | Die Set B | 25 |
| NRBRD-10-38-P25 | 10-12 | 3/8 | 1.339 (34.0) | 0.591 (15.0) | Die Set B | 25 |
| NRBRD-10-12-P20 | 10-12 | 1/2 | 1.520 (38.6) | 0.756 (19.2) | Die Set B | 20 |

All wire sizes, unless noted otherwise, are American Wire Gauge (AWG)
Tested to UL 486A/B, UL File E6207

Ring Terminals

Multi Stud



TYPE ILSCONS

A1

Features

- Ring tongue
- Multi-stud shape permits use with #6, #8, or #10 mounting screw
- Barrel allows for two crimps - NRBRD
- Funnel wire entry
- Vinyl insulation
- Nylon insulation
- Color coded
- Manufactured from high strength copper alloy
- Electro-tin plated
- Brazed barrel
- UL Listed for 600 volts, 105° C/221° F

Benefits

- Secure termination that cannot be removed unless the mounting screw is removed
- Versatile with multiple mounting screw sizes
- Provides strain relief, prevents exposure of wire conductors
- Smooth wire insertion into barrel
- Provides corrosion resistance and strain relief
- Increased heat and chemical resistant qualities for more demanding applications
- Provide easy wire range identification
- #18-22 AWG Red, #14-16 AWG Blue, #10-12 AWG Yellow
- Offers maximum conductivity
- Provides low contact resistance
- Stronger crimp connection that will not split open, prevents wire pull out
- Ensures reliability for copper conductor

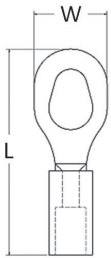

Fig. 1

Fig. 2

Fig. 3

| Catalog Number | Fig. No. | Wire Range | Stud Size | Dimensions - in. (mm) | | Installation Tool ILST-22K | Package Quantity |
|--------------------------------------------|----------|------------|-----------|-----------------------|--------------|-------------------------------|---------------------|
| | | | | L | W | | |
| BRBR- Non-Insulated | | | | | | | |
| BRBR-18-6MS-P50 | 1 | 18-22 | #6-10 | 0.786 (19.96) | 0.339 (8.61) | Die Set D1322 | 50 |
| BRBR-14-6MS-P50 | 1 | 14-16 | #6-10 | 0.786 (19.96) | 0.339 (8.61) | Die Set D1322 | 50 |
| BRBR-10-6MS-P50 | 1 | 10-12 | #6-10 | 0.886 (22.50) | 0.390 (9.91) | Die Set D1322 | 50 |
| VRBR- Vinyl-Insulated | | | | | | | |
| VRBR-18-6MS-P50 | 2 | 18-22 | #6-10 | 0.957 (24.31) | 0.339 (8.61) | Die Set A | 50 |
| VRBR-14-6MS-P50 | 2 | 14-16 | #6-10 | 0.957 (24.31) | 0.339 (8.61) | Die Set A | 50 |
| VRBR-10-6MS-P25 | 2 | 10-12 | #6-10 | 1.154 (29.31) | 0.390 (9.91) | Die Set A | 25 |
| NRBR- Nylon-Insulated | | | | | | | |
| NRBR-18-6MS-P50 | 2 | 18-22 | #6-10 | 0.996 (25.30) | 0.339 (8.61) | Die Set A | 50 |
| NRBR-14-6MS-P50 | 2 | 14-16 | #6-10 | 0.996 (25.30) | 0.339 (8.61) | Die Set A | 50 |
| NRBR-10-6MS-P25 | 2 | 10-12 | #6-10 | 1.154 (29.31) | 0.390 (9.91) | Die Set A | 25 |
| NRBRD- Nylon-Insulated-Double Crimp | | | | | | | |
| NRBRD-18-6MS-P50 | 3 | 18-22 | #6-10 | 0.996 (25.30) | 0.339 (8.61) | Die Set B | 50 |
| NRBRD-14-6MS-P50 | 3 | 14-16 | #6-10 | 0.996 (25.30) | 0.339 (8.61) | Die Set B | 50 |
| NRBRD-10-6MS-P25 | 3 | 10-12 | #6-10 | 1.154 (29.31) | 0.390 (9.91) | Die Set B | 25 |

All wire sizes, unless noted otherwise, are American Wire Gauge (AWG)
Tested to UL 486A/B, UL File E6207

Spade Terminals

Standard; Non-Insulated



TYPE ILSCONS

Features

- Spade configuration
- Funnel wire entry
- Manufactured from high strength copper alloy
- Electro-tin plated
- Brazed barrel
- UL Listed

Benefits

- Same benefit as the fork configuration, but with the added benefit of sides that are able to lie flat against barrier portion of terminal blocks
- Smooth wire insertion into barrel
- Offers maximum conductivity
- Provides low contact resistance
- Stronger crimp connection that will not split open, prevents wire pull out
- Ensures reliability for copper conductor

A1

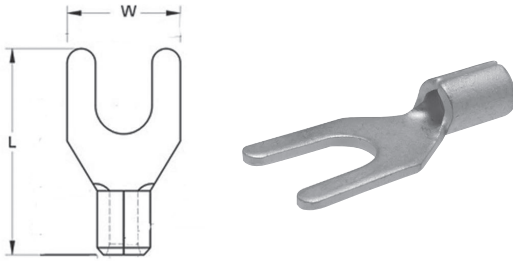

| Catalog Number | Wire Range | Stud Size | Dimensions - in. (mm) | | Installation Tool ILST-22K | Package Quantity |
|-----------------|------------|-----------|-----------------------|--------------|-------------------------------|---------------------|
| | | | L | W | | |
| BSBR-18-4-P50 | 18-22 | 4 | 0.630 (16.0) | 0.224 (5.7) | Die Set D1322 | 50 |
| BSBR-18-6-P50 | 18-22 | 6 | 0.630 (16.0) | 0.283 (7.2) | Die Set D1322 | 50 |
| BSBR-18-8-P50 | 18-22 | 8 | 0.630 (16.0) | 0.319 (8.1) | Die Set D1322 | 50 |
| BSBR-18-10-P50 | 18-22 | 10 | 0.630 (16.0) | 0.374 (9.5) | Die Set D1322 | 50 |
| BSBR-14-6-P50 | 14-16 | 6 | 0.630 (16.0) | 0.283 (7.2) | Die Set D1322 | 50 |
| BSBR-14-8-P50 | 14-16 | 8 | 0.630 (16.0) | 0.319 (8.1) | Die Set D1322 | 50 |
| BSBR-14-10-P50 | 14-16 | 10 | 0.630 (16.0) | 0.366 (9.3) | Die Set D1322 | 50 |
| BSBR-14-14-P50 | 14-16 | 1/4 | 0.630 (16.0) | 0.366 (9.3) | Die Set D1322 | 50 |
| BSBR-10-6-P50 | 10-12 | 6 | 0.728 (18.5) | 0.327 (8.3) | Die Set D1322 | 50 |
| BSBR-10-8-P50 | 10-12 | 8 | 0.720 (18.3) | 0.327 (8.3) | Die Set D1322 | 50 |
| BSBR-10-10-P50 | 10-12 | 10 | 0.720 (18.3) | 0.354 (9.0) | Die Set D1322 | 50 |
| BSBR-10-14-P50 | 10-12 | 1/4 | 0.965 (24.5) | 0.472 (12.0) | Die Set D1322 | 50 |
| BSBR-10-516-P50 | 10-12 | 5/16 | 0.925 (23.5) | 0.551 (14.0) | Die Set D1322 | 50 |

All wire sizes, unless noted otherwise, are American Wire Gauge (AWG)
Tested to UL 486A/B, UL File E6207

Spade Terminals

Standard; Vinyl Insulated

RoHS
Compliant



TYPE ILSCONS

A1

Features

- Spade configuration
- Funnel wire entry
- Vinyl insulation
- Color coded
- Manufactured from high strength copper alloy
- Electro-tin plated
- Brazed barrel
- UL Listed for 600 volts, 75° C/167° F

Benefits

- Same benefit as fork configuration, but with the added benefit of sides that are able to lie flat against barrier portion of terminal blocks
- Smooth wire insertion into barrel
- Provides corrosion resistance and strain relief
- Provide easy wire range identification
- #18-22 AWG Red, #14-16 AWG Blue, #10-12 AWG Yellow
- Offers maximum conductivity
- Provides low contact resistance
- Stronger crimp connection that will not split open, prevents wire pull out
- Ensures reliability for copper conductor

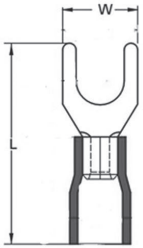

| Catalog Number | Wire Range | Stud Size | Dimensions - in. (mm) | | Installation Tool ILST-22K | Package Quantity |
|-----------------|------------|-----------|-----------------------|--------------|-------------------------------|---------------------|
| | | | L | W | | |
| VSBR-18-4-P50 | 18-22 | 4 | 0.827 (21.0) | 0.224 (5.7) | Die Set A | 50 |
| VSBR-18-6-P50 | 18-22 | 6 | 0.827 (21.0) | 0.283 (7.2) | Die Set A | 50 |
| VSBR-18-8-P50 | 18-22 | 8 | 0.827 (21.0) | 0.319 (8.1) | Die Set A | 50 |
| VSBR-18-10-P50 | 18-22 | 10 | 0.827 (21.0) | 0.374 (9.5) | Die Set A | 50 |
| VSBR-18-14-P50 | 18-22 | 1/4 | 1.063 (27.0) | 0.472 (12.0) | Die Set A | 50 |
| VSBR-14-6-P50 | 14-16 | 6 | 0.827 (21.0) | 0.283 (7.2) | Die Set A | 50 |
| VSBR-14-8-P50 | 14-16 | 8 | 0.827 (21.0) | 0.311 (7.9) | Die Set A | 50 |
| VSBR-14-10-P50 | 14-16 | 10 | 0.827 (21.0) | 0.366 (9.3) | Die Set A | 50 |
| VSBR-14-14-P50 | 14-16 | 1/4 | 1.063 (27.0) | 0.472 (12.0) | Die Set A | 50 |
| VSBR-10-6-P25 | 10-12 | 6 | 1.004 (25.5) | 0.327 (8.3) | Die Set A | 25 |
| VSBR-10-8-P25 | 10-12 | 8 | 1.004 (25.5) | 0.327 (8.3) | Die Set A | 25 |
| VSBR-10-10-P25 | 10-12 | 10 | 1.004 (25.5) | 0.354 (9.0) | Die Set A | 25 |
| VSBR-10-14-P25 | 10-12 | 1/4 | 1.240 (31.5) | 0.472 (12.0) | Die Set A | 25 |
| VSBR-10-516-P25 | 10-12 | 5 | 1.201 (30.5) | 0.551 (14.0) | Die Set A | 25 |

All wire sizes, unless noted otherwise, are American Wire Gauge (AWG)
Tested to UL 486A/B, UL File E6207

Spade Terminals

Standard; Nylon Insulated



TYPE ILSCONS

Features

- Spade configuration
- Funnel wire entry
- Nylon insulation
- Color coded
- Manufactured from high strength copper alloy
- Electro-tin plated
- Brazed barrel
- UL Listed for 600 volts, 105° C/221° F

Benefits

- Same benefit as the fork configuration, but with the added benefit of sides that are able to lie flat against barrier portion of terminal blocks
- Smooth wire insertion into barrel
- Increased heat and chemical resistant qualities for more demanding applications
- Provide easy wire range identification
- #18-22 AWG Red, #14-16 AWG Blue, #10-12 AWG Yellow
- Offers maximum conductivity
- Provides low contact resistance
- Stronger crimp connection that will not split open, prevents wire pull out
- Ensures reliability for copper conductor

A1

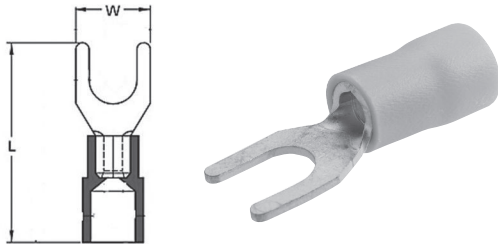

| Catalog Number | Wire Range | Stud Size | Dimensions - in. (mm) | | Installation Tool ILST-22K | Package Quantity |
|-----------------|------------|-----------|-----------------------|--------------|-------------------------------|---------------------|
| | | | L | W | | |
| NSBR-18-6-P50 | 18-22 | 6 | 0.866 (22.0) | 0.283 (7.2) | Die Set A | 50 |
| NSBR-18-8-P50 | 18-22 | 8 | 0.866 (22.0) | 0.319 (8.1) | Die Set A | 50 |
| NSBR-18-10-P50 | 18-22 | 10 | 0.866 (22.0) | 0.374 (9.5) | Die Set A | 50 |
| NSBR-18-14-P50 | 18-22 | 1/4 | 1.102 (28.0) | 0.472 (12.0) | Die Set A | 50 |
| NSBR-14-6-P50 | 14-16 | 6 | 0.866 (22.0) | 0.283 (7.2) | Die Set A | 50 |
| NSBR-14-8-P50 | 14-16 | 8 | 0.866 (22.0) | 0.311 (7.9) | Die Set A | 50 |
| NSBR-14-10-P50 | 14-16 | 10 | 0.866 (22.0) | 0.366 (9.3) | Die Set A | 50 |
| NSBR-14-14-P50 | 14-16 | 1/4 | 1.102 (28.0) | 0.472 (12.0) | Die Set A | 50 |
| NSBR-10-6-P25 | 10-12 | 6 | 1.004 (25.5) | 0.327 (8.3) | Die Set A | 25 |
| NSBR-10-8-P25 | 10-12 | 8 | 1.004 (25.5) | 0.327 (8.3) | Die Set A | 25 |
| NSBR-10-10-P25 | 10-12 | 10 | 1.004 (25.5) | 0.354 (9.0) | Die Set A | 25 |
| NSBR-10-14-P25 | 10-12 | 1/4 | 1.240 (31.5) | 0.472 (12.0) | Die Set A | 25 |
| NSBR-10-516-P25 | 10-12 | 1/3 | 1.201 (30.5) | 0.551 (14.0) | Die Set A | 25 |

All wire sizes, unless noted otherwise, are American Wire Gauge (AWG)
Tested to UL 486A/B, UL File E6207

Spade Terminals

Nylon Insulated Heavy Duty Double Crimp

RoHS
Compliant



TYPE ILSCONS

A1

Features

- Spade configuration
- Barrel allows for two crimps
- Funnel wire entry
- Nylon insulation
- Color coded
- Manufactured from high strength copper alloy
- Electro-tin plated
- Brazed barrel
- UL Listed for 600 volts, 105° C/221° F

Benefits

- Same benefit as the fork configuration, but with the added benefit of sides that are able to lie flat against barrier portion of terminal blocks
- Provides strain relief, prevents exposure of wire conductors
- Smooth wire insertion into barrel
- Increased heat and chemical resistant qualities for more demanding applications
- Provide easy wire range identification
- #18-22 AWG Red, #14-16 AWG Blue, #10-12 AWG Yellow
- Offers maximum conductivity
- Provides low contact resistance
- Stronger crimp connection that will not split open, prevents wire pull out
- Ensures reliability for copper conductor

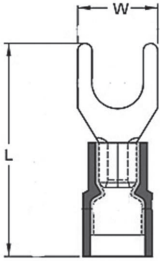

| Catalog Number | Wire Range | Stud Size | Dimensions - in. (mm) | | Installation Tool ILST-22K | Package Quantity |
|------------------|------------|-----------|-----------------------|--------------|-------------------------------|---------------------|
| | | | L | W | | |
| NSBRD-18-6-P50 | 18-22 | 6 | 0.866 (22.0) | 0.283 (7.2) | Die Set B | 50 |
| NSBRD-18-8-P50 | 18-22 | 8 | 0.866 (22.0) | 0.319 (8.1) | Die Set B | 50 |
| NSBRD-18-10-P50 | 18-22 | 10 | 0.866 (22.0) | 0.374 (9.5) | Die Set B | 50 |
| NSBRD-14-6-P50 | 14-16 | 6 | 0.866 (22.0) | 0.283 (7.2) | Die Set B | 50 |
| NSBRD-14-8-P50 | 14-16 | 8 | 0.866 (22.0) | 0.311 (7.9) | Die Set B | 50 |
| NSBRD-14-10-P50 | 14-16 | 10 | 0.866 (22.0) | 0.366 (9.3) | Die Set B | 50 |
| NSBRD-14-14-P50 | 14-16 | 1/4 | 1.102 (28.0) | 0.472 (12.0) | Die Set B | 50 |
| NSBRD-10-6-P25 | 10-12 | 6 | 1.004 (25.5) | 0.327 (8.3) | Die Set B | 25 |
| NSBRD-10-8-P25 | 10-12 | 8 | 1.004 (25.5) | 0.327 (8.3) | Die Set B | 25 |
| NSBRD-10-10-P25 | 10-12 | 10 | 1.004 (25.5) | 0.354 (9.0) | Die Set B | 25 |
| NSBRD-10-14-P25 | 10-12 | 1/4 | 1.240 (31.5) | 0.472 (12.0) | Die Set B | 25 |
| NSBRD-10-516-P25 | 10-12 | 5/16 | 1.201 (30.5) | 0.551 (14.0) | Die Set B | 25 |

Locking Spade Terminals

Standard; Non-Insulated



TYPE ILSCONS

Features

- Locking spade configuration
- Funnel wire entry
- Manufactured from high strength copper alloy
- Electro-tin plated
- Brazed barrel
- UL Listed

Benefits

- Specially designed tongue that allows the ILSCON to go on like a fork, and stay on like a ring
- Smooth wire insertion into barrel
- Offers maximum conductivity
- Provides low contact resistance
- Stronger crimp connection that will not split open, prevents wire pull out
- Ensures reliability for copper conductor

A1

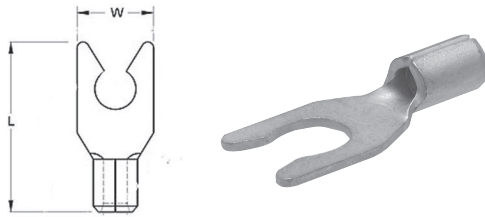

| Catalog Number | Wire Range | Stud Size | Dimensions - in. (mm) | | Installation Tool ILST-22K | Package Quantity |
|-----------------|------------|-----------|-----------------------|--------------|-------------------------------|---------------------|
| | | | L | W | | |
| BSLBR-18-6-P50 | 18-22 | 6 | 0.630 (16.0) | 0.252 (6.4) | Die Set D1322 | 50 |
| BSLBR-18-8-P50 | 18-22 | 8 | 0.630 (16.0) | 0.319 (8.1) | Die Set D1322 | 50 |
| BSLBR-18-10-P50 | 18-22 | 10 | 0.630 (16.0) | 0.374 (9.5) | Die Set D1322 | 50 |
| BSLBR-14-6-P50 | 14-16 | 6 | 0.630 (16.0) | 0.236 (6.0) | Die Set D1322 | 50 |
| BSLBR-14-8-P50 | 14-16 | 8 | 0.630 (16.0) | 0.319 (8.1) | Die Set D1322 | 50 |
| BSLBR-14-10-P50 | 14-16 | 10 | 0.630 (16.0) | 0.366 (9.3) | Die Set D1322 | 50 |
| BSLBR-10-6-P50 | 10-12 | 6 | 0.720 (18.3) | 0.307 (7.8) | Die Set D1322 | 50 |
| BSLBR-10-8-P50 | 10-12 | 8 | 0.717 (18.2) | 0.327 (8.3) | Die Set D1322 | 50 |
| BSLBR-10-10-P50 | 10-12 | 10 | 0.717 (18.2) | 0.354 (9.0) | Die Set D1322 | 50 |
| BSLBR-10-14-P50 | 10-12 | 1/4 | 0.965 (24.5) | 0.472 (12.0) | Die Set D1322 | 50 |

All wire sizes, unless noted otherwise, are American Wire Gauge (AWG)
Tested to UL 486A/B, UL File E6207

Locking Spade Terminals

Standard; Nylon Insulated

RoHS
Compliant



TYPE ILSCONS

A1

Features

- Locking spade configuration
- Funnel wire entry
- Nylon insulation
- Color coded
- Manufactured from high strength copper alloy
- Electro-tin plated
- Brazed barrel
- UL Listed for 600 volts, 105° C/221° F

Benefits

- Specially designed tongue that allows the ILSCON to go on like a fork, and stay on like a ring
- Smooth wire insertion into barrel
- Increased heat and chemical resistant qualities for more demanding applications
- Provide easy wire range identification
- #18-22 AWG Red, #14-16 AWG Blue, #10-12 AWG Yellow
- Offers maximum conductivity
- Provides low contact resistance
- Stronger crimp connection that will not split open, prevents wire pull out
- Ensures reliability for copper conductor

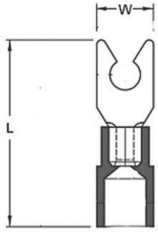

| Catalog Number | Wire Range | Stud Size | Dimensions - in. (mm) | | Installation Tool ILST-22K | Package Quantity |
|-----------------|------------|-----------|-----------------------|--------------|-------------------------------|---------------------|
| | | | L | W | | |
| NSLBR-18-6-P50 | 18-22 | 6 | 0.866 (22.0) | 0.252 (6.4) | Die Set A | 50 |
| NSLBR-18-8-P50 | 18-22 | 8 | 0.866 (22.0) | 0.319 (8.1) | Die Set A | 50 |
| NSLBR-18-10-P50 | 18-22 | 10 | 0.866 (22.0) | 0.374 (9.5) | Die Set A | 50 |
| NSLBR-14-6-P50 | 14-16 | 6 | 0.866 (22.0) | 0.236 (6.0) | Die Set A | 50 |
| NSLBR-14-8-P50 | 14-16 | 8 | 0.866 (22.0) | 0.319 (8.1) | Die Set A | 50 |
| NSLBR-14-10-P50 | 14-16 | 10 | 0.866 (22.0) | 0.366 (9.3) | Die Set A | 50 |
| NSLBR-10-6-P25 | 10-12 | 6 | 0.992 (25.2) | 0.327 (8.3) | Die Set A | 25 |
| NSLBR-10-8-P25 | 10-12 | 8 | 0.992 (25.2) | 0.327 (8.3) | Die Set A | 25 |
| NSLBR-10-10-P25 | 10-12 | 10 | 0.992 (25.2) | 0.354 (9.0) | Die Set A | 25 |
| NSLBR-10-14-P25 | 10-12 | 1/4 | 1.240 (31.5) | 0.472 (12.0) | Die Set A | 25 |

All wire sizes, unless noted otherwise, are American Wire Gauge (AWG)
Tested to UL 486A/B, UL File E6207

Locking Spade Terminals

Standard; Vinyl Insulated



TYPE ILSCONS

Features

- Locking spade configuration
- Funnel wire entry
- Vinyl insulation
- Color coded
- Manufactured from high strength copper alloy
- Electro-tin plated
- Brazed barrel
- UL Listed for 600 volts, 75° C/167° F

Benefits

- Specially designed tongue that allows the ILSCON to go on like a fork, and stay on like a ring
- Smooth wire insertion into barrel
- Provides corrosion resistance and strain relief
- Provide easy wire range identification
- #18-22 AWG Red, #14-16 AWG Blue, #10-12 AWG Yellow
- Offers maximum conductivity
- Provides low contact resistance
- Stronger crimp connection that will not split open, prevents wire pull out
- Ensures reliability for copper conductor

A1

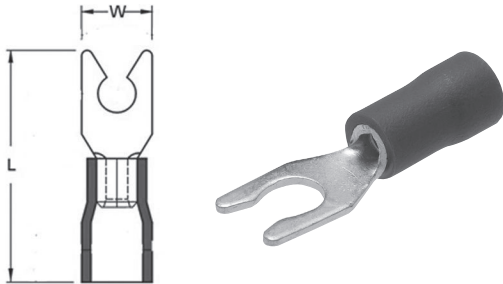

| Catalog Number | Wire Range | Stud Size | Dimensions - in. (mm) | | Installation Tool ILST-22K | Package Quantity |
|-----------------|------------|-----------|-----------------------|--------------|-------------------------------|---------------------|
| | | | L | W | | |
| VSLBR-18-6-P50 | 18-22 | 6 | 0.827 (21.0) | 0.252 (6.4) | Die Set A | 50 |
| VSLBR-14-6-P50 | 14-16 | 6 | 0.827 (21.0) | 0.236 (6.0) | Die Set A | 50 |
| VSLBR-14-10-P50 | 14-16 | 10 | 0.827 (21.0) | 0.366 (9.3) | Die Set A | 50 |
| VSLBR-10-6-P25 | 10-12 | 6 | 0.992 (25.2) | 0.327 (8.3) | Die Set A | 25 |
| VSLBR-10-8-P25 | 10-12 | 8 | 0.992 (25.2) | 0.327 (8.3) | Die Set A | 25 |
| VSLBR-10-10-P25 | 10-12 | 10 | 0.992 (25.2) | 0.354 (9.0) | Die Set A | 25 |
| VSLBR-10-14-P25 | 10-12 | 1/4 | 1.240 (31.5) | 0.472 (12.0) | Die Set A | 25 |

All wire sizes, unless noted otherwise, are American Wire Gauge (AWG)
Tested to UL 486A/B, UL File E6207

Locking Spade Terminals

Nylon Insulated Heavy Duty Double Crimp

RoHS
Compliant



TYPE ILSCONS

A1

Features

- Locking spade configuration
- Barrel allows for two crimps
- Funnel wire entry
- Nylon insulation
- Color coded
- Manufactured from high strength copper alloy
- Electro-tin plated
- Brazed barrel
- UL Listed for 600 volts, 105° C/221° F

Benefits

- Specially designed tongue that allows the ILSCON to go on like a fork, and stay on like a ring
- Provides strain relief, prevents exposure of wire conductors
- Smooth wire insertion into barrel
- Increased heat and chemical resistant qualities for more demanding applications
- Provide easy wire range identification
- #18-22 AWG Red, #14-16 AWG Blue, #10-12 AWG Yellow
- Offers maximum conductivity
- Provides low contact resistance
- Stronger crimp connection that will not split open, prevents wire pull out
- Ensures reliability for copper conductor

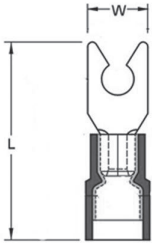

| Catalog Number | Wire Range | Stud Size | Dimensions - in. (mm) | | Installation Tool ILST-22K | Package Quantity |
|------------------|------------|-----------|-----------------------|--------------|-------------------------------|---------------------|
| | | | L | W | | |
| NSLBRD-18-6-P50 | 18-22 | 6 | 0.866 (22.0) | 0.252 (6.4) | Die Set B | 50 |
| NSLBRD-18-8-P50 | 18-22 | 8 | 0.866 (22.0) | 0.319 (8.1) | Die Set B | 50 |
| NSLBRD-18-10-P50 | 18-22 | 10 | 0.866 (22.0) | 0.374 (9.5) | Die Set B | 50 |
| NSLBRD-14-6-P50 | 14-16 | 6 | 0.866 (22.0) | 0.236 (6.0) | Die Set B | 50 |
| NSLBRD-14-8-P50 | 14-16 | 8 | 0.866 (22.0) | 0.319 (8.1) | Die Set B | 50 |
| NSLBRD-14-10-P50 | 14-16 | 10 | 0.866 (22.0) | 0.366 (9.3) | Die Set B | 50 |
| NSLBRD-10-6-P25 | 10-12 | 6 | 0.992 (25.2) | 0.327 (8.3) | Die Set B | 25 |
| NSLBRD-10-8-P25 | 10-12 | 8 | 0.992 (25.2) | 0.327 (8.3) | Die Set B | 25 |
| NSLBRD-10-10-P25 | 10-12 | 10 | 0.992 (25.2) | 0.354 (9.0) | Die Set B | 25 |
| NSLBRD-10-14-P25 | 10-12 | 1/4 | 1.240 (31.5) | 0.472 (12.0) | Die Set B | 25 |

All wire sizes, unless noted otherwise, are American Wire Gauge (AWG)
Tested to UL 486A/B, UL File E6207

Flanged Spade Terminals

Standard; Non-Insulated



TYPE ILSCONS

Features

- Spade configuration
- Flanged design
- Funnel wire entry
- Manufactured from high strength copper alloy
- Electro-tin plated
- Brazen barrel
- UL Listed

Benefits

- Same benefit as the fork configuration, but with the added benefit of sides that are able to lie flat against barrier portion of terminal blocks
- Provides extra secure connection on a variety of applications
- Smooth wire insertion into barrel
- Offers maximum conductivity
- Provides low contact resistance
- Stronger crimp connection that will not split open, prevents wire pull out
- Ensures reliability for copper conductor

A1

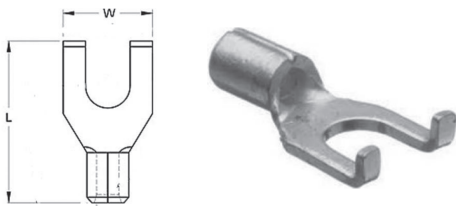

| Catalog Number | Wire Range | Stud Size | Dimensions - in. (mm) | | Installation Tool ILST-22K | Package Quantity |
|-----------------|------------|-----------|-----------------------|-------------|-------------------------------|---------------------|
| | | | L | W | | |
| BSFBR-18-6-P50 | 18-22 | 6 | 0.551 (14.0) | 0.295 (7.5) | Die Set D1322 | 50 |
| BSFBR-18-8-P50 | 18-22 | 8 | 0.768 (19.5) | 0.335 (8.5) | Die Set D1322 | 50 |
| BSFBR-18-10-P50 | 18-22 | 10 | 0.768 (19.5) | 0.335 (8.5) | Die Set D1322 | 50 |
| BSFBR-14-6-P50 | 14-16 | 6 | 0.709 (18.0) | 0.295 (7.5) | Die Set D1322 | 50 |
| BSFBR-14-8-P50 | 14-16 | 8 | 0.709 (18.0) | 0.335 (8.5) | Die Set D1322 | 50 |
| BSFBR-14-10-P50 | 14-16 | 10 | 0.709 (18.0) | 0.335 (8.5) | Die Set D1322 | 50 |
| BSFBR-10-6-P50 | 10-12 | 6 | 0.787 (20.0) | 0.335 (8.5) | Die Set D1322 | 50 |
| BSFBR-10-8-P50 | 10-12 | 8 | 0.787 (20.0) | 0.335 (8.5) | Die Set D1322 | 50 |
| BSFBR-10-10-P50 | 10-12 | 10 | 0.787 (20.0) | 0.335 (8.5) | Die Set D1322 | 50 |

All wire sizes, unless noted otherwise, are American Wire Gauge (AWG)
Tested to UL 486A/B, UL File E6207

Flanged Spade Terminals

Standard; Nylon Insulated

RoHS
Compliant

UL
LISTED
2000

TYPE ILSCONS

A1

Features

- Spade configuration
- Flanged design
- Funnel wire entry
- Nylon insulation
- Color coded
- Manufactured from high strength copper alloy
- Electro-tin plated
- Brazed barrel
- UL Listed for 600 volts, 105° C/221° F

Benefits

- Same benefit as the fork configuration, but with the added benefit of sides that are able to lie flat against barrier portion of terminal blocks
- Provides extra secure connection on a variety of applications
- Smooth wire insertion into barrel
- Increased heat and chemical resistant qualities for more demanding applications
- Provide easy wire range identification
- #18-22 AWG Red, #14-16 AWG Blue, #10-12 AWG Yellow
- Offers maximum conductivity
- Provides low contact resistance
- Stronger crimp connection that will not split open, prevents wire pull out
- Ensures reliability for copper conductor

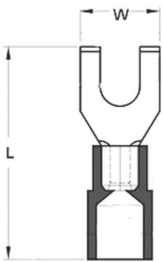

| Catalog Number | Wire Range | Stud Size | Dimensions - in. (mm) | | Installation Tool ILST-22K | Package Quantity |
|-----------------|------------|-----------|-----------------------|-------------|-------------------------------|---------------------|
| | | | L | W | | |
| NSFBR-18-6-P50 | 18-22 | 6 | 0.787 (20.0) | 0.295 (7.5) | Die Set A | 50 |
| NSFBR-18-8-P50 | 18-22 | 8 | 1.004 (25.5) | 0.335 (8.5) | Die Set A | 50 |
| NSFBR-18-10-P50 | 18-22 | 10 | 1.004 (25.5) | 0.335 (8.5) | Die Set A | 50 |
| NSFBR-14-6-P50 | 14-16 | 6 | 0.807 (20.5) | 0.295 (7.5) | Die Set A | 50 |
| NSFBR-14-8-P50 | 14-16 | 8 | 0.945 (24.0) | 0.335 (8.5) | Die Set A | 50 |
| NSFBR-14-10-P50 | 14-16 | 10 | 0.945 (24.0) | 0.335 (8.5) | Die Set A | 50 |
| NSFBR-10-6-P25 | 10-12 | 6 | 1.063 (27.0) | 0.335 (8.5) | Die Set A | 25 |
| NSFBR-10-8-P25 | 10-12 | 8 | 1.063 (27.0) | 0.335 (8.5) | Die Set A | 25 |
| NSFBR-10-10-P25 | 10-12 | 10 | 1.063 (27.0) | 0.335 (8.5) | Die Set A | 25 |

All wire sizes, unless noted otherwise, are American Wire Gauge (AWG)
Tested to UL 486A/B, UL File E6207

Flanged Spade Terminals

Standard; Vinyl Insulated



TYPE ILSCONS

Features

- Spade configuration
- Flanged design
- Funnel wire entry
- Vinyl insulation
- Color coded
- Manufactured from high strength copper alloy
- Electro-tin plated
- Brazed barrel
- UL Listed for 600 volts, 105° C/221° F

Benefits

- Same benefit as fork configuration, but with the added benefit of sides that are able to lie flat against the barrier portion of terminal blocks
- Provides extra secure connection on a variety of applications
- Smooth wire insertion into barrel
- Provides corrosion resistance and strain relief
- Provide easy wire range identification
- #18-22 AWG Red, #14-16 AWG Blue, #10-12 AWG Yellow
- Offers maximum conductivity
- Provides low contact resistance
- Stronger crimp connection that will not split open, prevents wire pull out
- Ensures reliability for copper conductor

A1

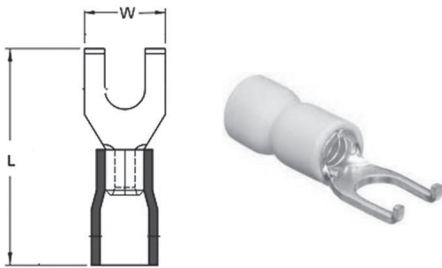

| Catalog Number | Wire Range | Stud Size | Dimensions - in. (mm) | | | Installation Tool ILST-22K | Package Quantity |
|-----------------|------------|-----------|-----------------------|-------------|------------------------------------|-------------------------------|---------------------|
| | | | L | W | Maximum Wire Insulated Diameter | | |
| VSFBR-18-6-P50 | 18-22 | 6 | 0.748 (19.0) | 0.295 (7.5) | 0.157 (4.0) | Die Set A | 50 |
| VSFBR-18-8-P50 | 18-22 | 8 | 0.748 (19.0) | 0.295 (7.5) | 0.157 (4.0) | Die Set A | 50 |
| VSFBR-18-10-P50 | 18-22 | 10 | 0.965 (24.5) | 0.335 (8.5) | 0.157 (4.0) | Die Set A | 50 |
| VSFBR-14-6-P50 | 14-16 | 6 | 0.748 (19.0) | 0.295 (7.5) | 0.177 (4.5) | Die Set A | 50 |
| VSFBR-14-8-P50 | 14-16 | 8 | 0.906 (23.0) | 0.335 (8.5) | 0.177 (4.5) | Die Set A | 50 |
| VSFBR-14-10-P50 | 14-16 | 10 | 0.906 (23.0) | 0.335 (8.5) | 0.177 (4.5) | Die Set A | 50 |
| VSFBR-10-6-P25 | 10-12 | 6 | 1.063 (27.0) | 0.335 (8.5) | 0.252 (6.4) | Die Set A | 25 |
| VSFBR-10-8-P25 | 10-12 | 8 | 1.063 (27.0) | 0.335 (8.5) | 0.252 (6.4) | Die Set A | 25 |
| VSFBR-10-10-P25 | 10-12 | 10 | 1.063 (27.0) | 0.335 (8.5) | 0.252 (6.4) | Die Set A | 25 |

All wire sizes, unless noted otherwise, are American Wire Gauge (AWG)
Tested to UL 486A/B, UL File E6207

Flanged Spade Terminals

Nylon Insulated Heavy Duty Double Crimp

RoHS
Compliant



TYPE ILSCONS

A1

Features

- Spade configuration
- Flanged design
- Barrel allows for two crimps
- Funnel wire entry
- Nylon insulation
- Color coded
- Manufactured from high strength copper alloy
- Electro-tin plated
- Brazed barrel
- UL Listed for 600 volts, 105° C/221° F

Benefits

- Same benefit as the fork configuration, but with the added benefit of sides that are able to lie flat against barrier portion of terminal blocks
- Provides extra secure connection on a variety of applications
- Provides strain relief, prevents exposure of wire conductors
- Smooth wire insertion into barrel
- Increased heat and chemical resistant qualities for more demanding applications
- Provide easy wire range identification
- #18-22 AWG Red, #14-16 AWG Blue, #10-12 AWG Yellow
- Offers maximum conductivity
- Provides low contact resistance
- Stronger crimp connection that will not split open, prevents wire pull out
- Ensures reliability for copper conductor

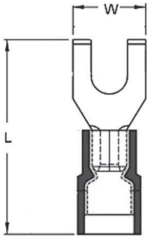

| Catalog Number | Wire Range | Stud Size | Dimensions - in. (mm) | | Installation Tool ILST-22K | Package Quantity |
|------------------|------------|-----------|-----------------------|-------------|-------------------------------|---------------------|
| | | | L | W | | |
| NSFBRD-18-6-P50 | 18-22 | 6 | 0.787 (20.0) | 0.295 (7.5) | Die Set B | 50 |
| NSFBRD-18-8-P50 | 18-22 | 8 | 1.004 (25.5) | 0.335 (8.5) | Die Set B | 50 |
| NSFBRD-18-10-P50 | 18-22 | 10 | 1.004 (25.5) | 0.335 (8.5) | Die Set B | 50 |
| NSFBRD-14-6-P50 | 14-16 | 6 | 0.807 (20.5) | 0.295 (7.5) | Die Set B | 50 |
| NSFBRD-14-8-P50 | 14-16 | 8 | 0.945 (24.0) | 0.335 (8.5) | Die Set B | 50 |
| NSFBRD-14-10-P50 | 14-16 | 10 | 0.945 (24.0) | 0.335 (8.5) | Die Set B | 50 |
| NSFBRD-10-6-P25 | 10-12 | 6 | 1.063 (27.0) | 0.335 (8.5) | Die Set B | 25 |
| NSFBRD-10-8-P25 | 10-12 | 8 | 1.063 (27.0) | 0.335 (8.5) | Die Set B | 25 |
| NSFBRD-10-10-P25 | 10-12 | 10 | 1.063 (27.0) | 0.335 (8.5) | Die Set B | 25 |

All wire sizes, unless noted otherwise, are American Wire Gauge (AWG)
Tested to UL 486A/B, UL File E6207

Fork Terminals

Standard; Non-Insulated



TYPE ILSCONS

Features

- Fork configuration
- Funnel entry
- Manufactured from high strength copper alloy
- Electro-tin plated
- Brazed barrel
- UL Listed

Benefits

- Allows easy installation since mounting screw needs only to be loosened
- Smooth wire insertion into barrel
- Offers maximum conductivity
- Provides low contact resistance
- Stronger crimp connection that will not split open, prevents wire pull out
- Ensures reliability for copper conductor

A1



| Catalog Number | Wire Range | Stud Size | Dimensions - in. (mm) | | Installation Tool ILST-22K | Package Quantity |
|----------------|------------|-----------|-----------------------|--------------|-------------------------------|---------------------|
| | | | L | W | | |
| BFBR-18-6-P50 | 18-22 | 6 | 0.531 (13.5) | 0.260 (6.6) | Die Set D1322 | 50 |
| BFBR-18-8-P50 | 18-22 | 8 | 0.583 (14.8) | 0.315 (8.0) | Die Set D1322 | 50 |
| BFBR-18-10-P50 | 18-22 | 10 | 0.567 (14.4) | 0.315 (8.0) | Die Set D1322 | 50 |
| BFBR-18-14-P50 | 18-22 | 1/4 | 0.799 (20.3) | 0.457 (11.6) | Die Set D1322 | 50 |
| BFBR-14-6-P50 | 14-16 | 6 | 0.531 (13.5) | 0.260 (6.6) | Die Set D1322 | 50 |
| BFBR-14-8-P50 | 14-16 | 8 | 0.626 (15.9) | 0.335 (8.5) | Die Set D1322 | 50 |
| BFBR-14-10-P50 | 14-16 | 10 | 0.614 (15.6) | 0.374 (9.5) | Die Set D1322 | 50 |
| BFBR-14-14-P50 | 14-16 | 1/4 | 0.807 (20.5) | 0.472 (12.0) | Die Set D1322 | 50 |
| BFBR-10-8-P50 | 10-12 | 8 | 0.563 (14.3) | 0.283 (7.2) | Die Set D1322 | 50 |
| BFBR-10-10-P50 | 10-12 | 10 | 0.732 (18.6) | 0.374 (9.5) | Die Set D1322 | 50 |
| BFBR-10-14-P50 | 10-12 | 1/4 | 0.835 (21.2) | 0.472 (12.0) | Die Set D1322 | 50 |

All wire sizes, unless noted otherwise, are American Wire Gauge (AWG)
Tested to UL 486A/B, UL File E6207

Fork Terminals

Standard; Nylon Insulated



TYPE ILSCONS

A1

Features

- Fork configuration
- Funnel wire entry
- Nylon insulation
- Color coded
- Manufactured from high strength copper alloy
- Electro-tin plated
- Brazed barrel
- UL Listed for 600 volts, 105° C/221° F

Benefits

- Allows easy installation since mounting screw needs only to be loosened
- Smooth wire insertion into barrel
- Increased heat and chemical resistant qualities for more demanding applications
- Provide easy wire range identification
- #18-22 AWG Red, #14-16 AWG Blue, #10-12 AWG Yellow
- Offers maximum conductivity
- Provides low contact resistance
- Stronger crimp connection that will not split open, prevents wire pull out
- Ensures reliability for copper conductor

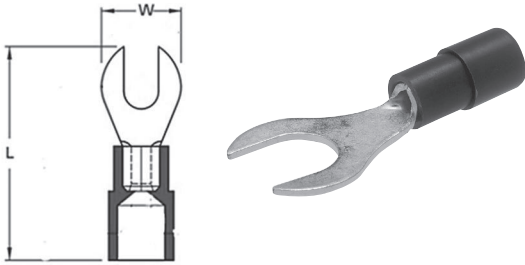

| Catalog Number | Wire Range | Stud Size | Dimensions - in. (mm) | | | Maximum Wire Insulated Diameter | Installation Tool ILST-22K | Package Quantity |
|----------------|------------|-----------|-----------------------|--------------|--|---------------------------------|----------------------------|------------------|
| | | | L | W | | | | |
| NFBR-18-14-P50 | 18-22 | 1/4 | 1.035 (26.3) | 0.457 (11.6) | | 0.157 (4.0) | Die Set A | 50 |
| NFBR-14-6-P50 | 14-16 | 6 | 0.768 (19.5) | 0.260 (6.6) | | 0.177 (4.5) | Die Set A | 50 |
| NFBR-14-14-P50 | 14-16 | 1/4 | 1.043 (26.5) | 0.472 (12.0) | | 0.177 (4.5) | Die Set A | 50 |
| NFBR-10-14-P25 | 10-12 | 1/4 | 1.110 (28.2) | 0.472 (12.0) | | 0.252 (6.4) | Die Set A | 25 |

All wire sizes, unless noted otherwise, are American Wire Gauge (AWG)
Tested to UL 486A/B, UL File E6207

Fork Terminals

Standard; Vinyl Insulated



TYPE ILSCONS

Features

- Fork configuration
- Funnel wire entry
- Vinyl insulation
- Color coded
- Manufactured from high strength copper alloy
- Electro-tin plated
- Brazed barrel
- UL Listed for 600 volts, 105° C/221° F

Benefits

- Allows easy installation since mounting screw needs only to be loosened
- Smooth wire insertion into barrel
- Provides corrosion resistance and strain relief
- Provide easy wire range identification
- #18-22 AWG Red, #14-16 AWG Blue, #10-12 AWG Yellow
- Offers maximum conductivity
- Provides low contact resistance
- Stronger crimp connection that will not split open, prevents wire pull out
- Ensures reliability for copper conductor

A1

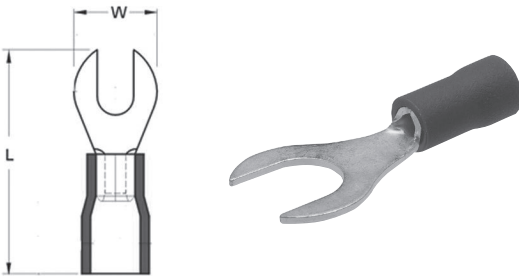

| Catalog Number | Wire Range | Stud Size | Dimensions - in. (mm) | | Installation Tool ILST-22K | Package Quantity |
|----------------|------------|-----------|-----------------------|--------------|-------------------------------|---------------------|
| | | | L | W | | |
| VFBR-18-14-P50 | 18-22 | 1/4 | 0.996 (25.3) | 0.457 (11.6) | Die Set A | 50 |
| VFBR-14-14-P50 | 14-16 | 1/4 | 1.004 (25.5) | 0.472 (12.0) | Die Set A | 50 |
| VFBR-10-14-P25 | 10-12 | 1/4 | 1.110 (28.2) | 0.472 (12.0) | Die Set A | 25 |

All wire sizes, unless noted otherwise, are American Wire Gauge (AWG)
Tested to UL 486A/B, UL File E6207

Fork Terminals

Nylon Insulated Heavy Duty Double Crimp

RoHS
Compliant



TYPE ILSCONS

A1

Features

- Fork tongue
- Barrel allows for two crimps
- Funnel wire entry
- Nylon insulation
- Color coded
- Manufactured from high strength copper alloy
- Electro-tin plated
- Brazed barrel
- UL Listed for 600 volts, 105° C/221° F

Benefits

- Allows easy installation since mounting screw needs only to be loosened
- Provides strain relief, prevents exposure of wire conductors
- Smooth wire insertion into barrel
- Increased heat and chemical resistant qualities for more demanding applications
- Provide easy wire range identification
- #18-22 AWG Red, #14-16 AWG Blue, #10-12 AWG Yellow
- Offers maximum conductivity
- Provides low contact resistance
- Stronger crimp connection that will not split open, prevents wire pull out
- Ensures reliability for copper conductor

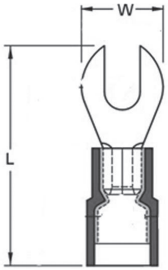

| Catalog Number | Wire Range | Stud Size | Dimensions - in. (mm) | | Installation Tool ILST-22K | Package Quantity |
|-----------------|------------|-----------|-----------------------|--------------|-------------------------------|---------------------|
| | | | L | W | | |
| NFBRD-18-6-P50 | 18-22 | 6 | 0.768 (19.5) | 0.260 (6.6) | Die Set B | 50 |
| NFBRD-18-14-P50 | 18-22 | 1/4 | 1.035 (26.3) | 0.457 (11.6) | Die Set B | 50 |
| NFBRD-14-8-P50 | 14-16 | 8 | 0.862(21.9) | 0.335 (8.5) | Die Set B | 50 |
| NFBRD-14-14-P50 | 14-16 | 1/4 | 1.047 (26.6) | 0.472 (12.0) | Die Set B | 50 |
| NFBRD-10-8-P25 | 10-12 | 8 | 0.839 (21.3) | 0.283 (7.2) | Die Set B | 25 |
| NFBRD-10-10-P25 | 10-12 | 10 | 1.008 (25.6) | 0.374 (9.5) | Die Set B | 25 |
| NFBRD-10-14-P25 | 10-12 | 1/4 | 1.110 (28.2) | 0.472 (12.0) | Die Set B | 25 |

All wire sizes, unless noted otherwise, are American Wire Gauge (AWG)
Tested to UL 486A/B, UL File E6207

Disconnect Terminals

Standard Female



TYPE ILSCONS

Features

- Female disconnect configuration
- Barrel allows for two crimps - NDFTD
- Funnel wire entry
- Vinyl insulation - VDFT
- Nylon insulation - NDFT, NDFTD
- Color coded
- Manufactured from high strength brass alloy
- Electro-tin plated
- UL Listed

Benefits

- Allows for fast, reliable, convenient connection to male tab without the use of tools
- Provides strain relief, prevents exposure of wire conductors
- Smooth wire insertion into barrel
- Provides corrosion resistance and strain relief
- Increased heat and chemical resistant qualities for more demanding applications
- Provide easy wire range identification
- #18-22 AWG Red, #14-16 AWG Blue, #10-12 AWG Yellow
- Offers maximum conductivity
- Provides low contact resistance
- Ensures reliability for brass conductor

A1

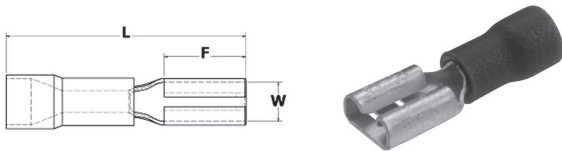

| Catalog Number | Wire Range | Voltage Rating | Temp Rating | Dimensions - in. (mm) | | | Tab Size | Installation Tool ILST-22K | Package Quantity |
|-----------------------------------------------------|------------|----------------|------------------|-----------------------|--------------|--------------|-------------|----------------------------|------------------|
| | | | | L | W | F | | | |
| VDFT- Vinyl Insulated- Female | | | | | | | | | |
| VDFT-18-110-P50 | 18-22 | 300 V | 75° C/ 167° F | 0.732 (18.59) | 0.126 (3.20) | 0.256 (6.50) | .110 x .020 | Die Set C | 50 |
| VDFT-18-187-P50 | 18-22 | 300 V | 75° C/ 167° F | 0.748 (19.00) | 0.197 (5.00) | 0.252 (6.40) | .187 x .020 | Die Set C | 50 |
| VDFT-18-250-P50 | 18-22 | 300 V | 75° C/ 167° F | 0.807 (20.50) | 0.260 (6.60) | 0.295 (7.49) | .250 x .032 | Die Set C | 50 |
| VDFT-14-110-P50 | 14-16 | 300 V | 75° C/ 167° F | 0.732 (18.59) | 0.126 (3.20) | 0.256 (6.50) | .110 x .020 | Die Set C | 50 |
| VDFT-14-187-P50 | 14-16 | 300 V | 75° C/ 167° F | 0.748 (19.00) | 0.197 (5.00) | 0.252 (6.40) | .187 x .020 | Die Set C | 50 |
| VDFT-14-250-P50 | 14-16 | 300 V | 75° C/ 167° F | 0.807 (20.50) | 0.260 (6.60) | 0.295 (7.49) | .250 x .032 | Die Set C | 50 |
| VDFT-10-250-P25 | 10-12 | 300 V | 75° C/ 167° F | 0.925 (23.50) | 0.260 (6.60) | 0.295 (7.49) | .250 x .032 | Die Set C | 25 |
| NDFT- Nylon-Insulated- Female | | | | | | | | | |
| NDFT-18-110-P50 | 18-22 | 300 V | 105° C | 0.772 (19.61) | 0.126 (3.20) | 0.256 (6.50) | .110 x .020 | Die Set C | 50 |
| NDFT-18-187-P50 | 18-22 | 300 V | 105° C | 0.787 (19.99) | 0.197 (5.00) | 0.252 (6.40) | .187 x .020 | Die Set C | 50 |
| NDFT-18-250-P50 | 18-22 | 300 V | 105° C | 0.846 (21.49) | 0.260 (6.60) | 0.295 (7.49) | .250 x .032 | Die Set C | 50 |
| NDFT-14-110-P50 | 14-16 | 300 V | 105° C | 0.772 (19.61) | 0.126 (3.20) | 0.256 (6.50) | .110 x .020 | Die Set C | 50 |
| NDFT-14-187-P50 | 14-16 | 300 V | 105° C | 0.787 (19.99) | 0.197 (5.00) | 0.252 (6.40) | .187 x .020 | Die Set C | 50 |
| NDFT-14-250-P50 | 14-16 | 300 V | 105° C | 0.846 (21.49) | 0.260 (6.60) | 0.295 (7.49) | .250 x .032 | Die Set C | 50 |
| NDFT-10-250-P25 | 10-12 | 300 V | 105° C | 0.925 (23.50) | 0.260 (6.60) | 0.295 (7.49) | .250 x .032 | Die Set C | 25 |
| NDFTD- Nylon-Insulated- Female- Double Crimp | | | | | | | | | |
| NDFTD-18-110-P50 | 18-22 | 600 V | 105° C | 0.772 (19.61) | 0.126 (3.20) | 0.256 (6.50) | .110 x .020 | Die Set B | 50 |
| NDFTD-18-187-P50 | 18-22 | 600 V | 105° C | 0.787 (19.99) | 0.197 (5.00) | 0.252 (6.40) | .187 x .020 | Die Set B | 50 |
| NDFTD-18-250-P50 | 18-22 | 600 V | 105° C | 0.846 (21.49) | 0.260 (6.60) | 0.295 (7.49) | .250 x .032 | Die Set B | 50 |
| NDFTD-14-110-P50 | 14-16 | 600 V | 105° C | 0.772 (19.61) | 0.126 (3.20) | 0.256 (6.50) | .110 x .020 | Die Set B | 50 |
| NDFTD-14-187-P50 | 14-16 | 600 V | 105° C | 0.787 (19.99) | 0.197 (5.00) | 0.252 (6.40) | .187 x .020 | Die Set B | 50 |
| NDFTD-14-250-P50 | 14-16 | 600 V | 105° C | 0.846 (21.49) | 0.260 (6.60) | 0.295 (7.49) | .250 x .032 | Die Set B | 50 |
| NDFTD-10-187-P25 | 10-12 | 600 V | 105° C | 0.866 (22.00) | 0.197 (5.00) | 0.256 (6.50) | .187 x .020 | Die Set B | 25 |
| NDFTD-10-250-P25 | 10-12 | 600 V | 105° C | 0.925 (23.50) | 0.260 (6.60) | 0.295 (7.49) | .250 x .032 | Die Set B | 25 |

All wire sizes, unless noted otherwise, are American Wire Gauge (AWG)
Tested to UL 310, UL File E474613

Disconnect Terminals

Standard Male

RoHS
Compliant

UL
LISTED
19X5

TYPE ILSCONS

A1

Features

- Male disconnect configuration
- Barrel allows for two crimps - NDMTD
- Funnel wire entry
- Vinyl insulation - VDMT
- Nylon insulation - NDMT, NDMTD
- Color coded
- Manufactured from high strength brass alloy
- Electro-tin plated
- UL Listed

Benefits

- Mates with matching female tab sizes to ensure a firm grip
- Provides strain relief, prevents exposure of wire conductors
- Smooth wire insertion into barrel
- Provides corrosion resistance and strain relief
- Increased heat and chemical resistant qualities for more demanding applications
- Provide easy wire range identification
- #18-22 AWG Red, #14-16 AWG Blue, #10-12 AWG Yellow
- Offers maximum conductivity
- Provides low contact resistance
- Ensures reliability for brass conductor

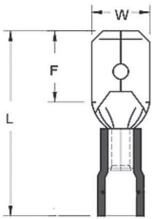

| Catalog Number | Wire Range | Voltage Rating | Temp Rating | Dimensions - in. (mm) | | | Tab Size | Installation Tool ILST-22K | Package Quantity |
|---------------------------------------------------|------------|----------------|------------------|-----------------------|--------------|--------------|-------------|----------------------------|------------------|
| | | | | L | W | F | | | |
| VDMT- Vinyl-Insulated- Male | | | | | | | | | |
| VDMT-18-110-P50 | 18-22 | 300 V | 75° C/ 167° F | 0.728 (18.49) | 0.110 (2.79) | 0.256 (6.50) | .110 x .020 | Die Set C | 50 |
| VDMT-18-187-P50 | 18-22 | 300 V | 75° C/ 167° F | 0.748 (19.00) | 0.189 (4.80) | 0.256 (6.50) | .187 x .020 | Die Set C | 50 |
| VDMT-18-250-P50 | 18-22 | 300 V | 75° C/ 167° F | 0.827 (21.01) | 0.250 (6.35) | 0.303 (7.70) | .250 x .032 | Die Set C | 50 |
| VDMT-14-187-P50 | 14-16 | 300 V | 75° C/ 167° F | 0.748 (19.00) | 0.189 (4.80) | 0.256 (6.50) | .187 x .020 | Die Set C | 50 |
| VDMT-14-250-P50 | 14-16 | 300 V | 75° C/ 167° F | 0.827 (21.01) | 0.250 (6.35) | 0.303 (7.70) | .250 x .032 | Die Set C | 50 |
| VDMT-10-250-P25 | 10-12 | 300 V | 75° C/ 167° F | 0.945 (24.00) | 0.250 (6.35) | 0.303 (7.70) | .250 x .032 | Die Set C | 25 |
| NDMT- Nylon- Insulated- Male | | | | | | | | | |
| NDMT-18-110-P50 | 18-22 | 300 V | 105° C | 0.768 (19.51) | 0.110 (2.79) | 0.256 (6.50) | .110 x .020 | Die Set C | 50 |
| NDMT-18-187-P50 | 18-22 | 300 V | 105° C | 0.787 (19.99) | 0.189 (4.80) | 0.256 (6.50) | .187 x .020 | Die Set C | 50 |
| NDMT-18-250-P50 | 18-22 | 300 V | 105° C | 0.866 (22.00) | 0.250 (6.35) | 0.303 (7.70) | .250 x .032 | Die Set C | 50 |
| NDMT-14-187-P50 | 14-16 | 300 V | 105° C | 0.787 (19.99) | 0.189 (4.80) | 0.256 (6.50) | .187 x .020 | Die Set C | 50 |
| NDMT-14-250-P50 | 14-16 | 300 V | 105° C | 0.866 (22.00) | 0.250 (6.35) | 0.303 (7.70) | .250 x .032 | Die Set C | 50 |
| NDMT-10-250-P25 | 10-12 | 300 V | 105° C | 0.945 (24.00) | 0.250 (6.35) | 0.303 (7.70) | .250 x .032 | Die Set C | 25 |
| NDMTD- Nylon-Insulated- Male- Double Crimp | | | | | | | | | |
| NDMTD-18-110-P50 | 18-22 | 600 V | 105° C | 0.768 (19.51) | 0.110 (2.79) | 0.256 (6.50) | .110 x .020 | Die Set B | 50 |
| NDMTD-18-187-P50 | 18-22 | 600 V | 105° C | 0.787 (19.99) | 0.189 (4.80) | 0.256 (6.50) | .187 x .020 | Die Set B | 50 |
| NDMTD-18-250-P50 | 18-22 | 600 V | 105° C | 0.866 (22.00) | 0.250 (6.35) | 0.303 (7.70) | .250 x .032 | Die Set B | 50 |
| NDMTD-14-187-P50 | 14-16 | 600 V | 105° C | 0.787 (19.99) | 0.189 (4.80) | 0.256 (6.50) | .187 x .020 | Die Set B | 50 |
| NDMTD-14-250-P50 | 14-16 | 600 V | 105° C | 0.874 (22.20) | 0.250 (6.35) | 0.303 (7.70) | .250 x .032 | Die Set B | 50 |
| NDMTD-10-250-P25 | 10-12 | 600 V | 105° C | 0.945 (24.00) | 0.250 (6.35) | 0.303 (7.70) | .250 x .032 | Die Set B | 25 |

All wire sizes, unless noted otherwise, are American Wire Gauge (AWG)

Tested to UL 310, UL File E474613

Disconnect Terminals

Fully Insulated



TYPE ILSCONS

Features

- Female and male disconnect configurations
- Industry standard sizes
- Fully insulated
- Funnel wire entry
- Vinyl insulation - VFIDT
- Nylon insulation - NFIFT, NFIMT
- Color coded
- Manufactured from high strength brass alloy
- Electro-tin plated
- UL Listed, see ratings in chart below

Benefits

- Allows for reliable, easy and quick connection/disconnection
- Mates with matching tab sizes to ensure a firm grip
- Provides protection from electrical shorts and eliminates the need for post installation insulation
- Smooth wire insertion into barrel
- Provides corrosion resistance and strain relief
- Increased heat and chemical resistant qualities for more demanding applications
- Provide easy wire range identification
- #18-22 AWG Red, #14-16 AWG Blue, #10-12 AWG Yellow
- Offers maximum conductivity
- Provides low contact resistance
- Ensures reliability for brass conductor

A1

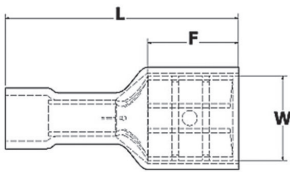

Fig. 1



Fig. 2

| Catalog Number | Fig. No. | Wire Range | Voltage Rating | Temp Rating | Dimensions - in. (mm) | | | Tab Size | Installation Tool ILST-22K | Package Quantity |
|------------------------------------------|----------|------------|----------------|------------------|-----------------------|--------------|--------------|-------------|-------------------------------|------------------|
| | | | | | L | W | F | | | |
| VFIDT - Vinyl Insulation - Female | | | | | | | | | | |
| VFIDT-18-187-P50 | 1 | 18-22 | 300 V | 75° C/ 167° F | 0.768 (19.51) | 0.197 (5.00) | 0.252 (6.40) | .187 x .020 | Die Set C | 50 |
| VFIDT-10-250-P25 | 1 | 10-12 | 300 V | 75° C/ 167° F | 0.957 (24.31) | 0.260 (6.60) | 0.295 (7.49) | .250 x .032 | Die Set C | 50 |
| NFIFT-Nylon Insulation - Female | | | | | | | | | | |
| NFIFT-18-250-P50 | 1 | 18-22 | 300 V | 105° C | 0.886 (22.50) | 0.260 (6.60) | 0.295 (7.49) | .250 x .032 | Die Set C | 50 |
| NFIFT-14-250-P50 | 1 | 14-16 | 300 V | 105° C | 0.866 (22.00) | 0.260 (6.60) | 0.295 (7.49) | .250 x .032 | Die Set C | 50 |
| NFIFT-10-250-P25 | 1 | 10-12 | 300 V | 105° C | 0.945 (24.00) | 0.260 (6.60) | 0.295 (7.49) | .250 x .032 | Die Set C | 25 |
| NFIMT-Nylon Insulation - Male | | | | | | | | | | |
| NFIMT-18-250-P25 | 2 | 18-22 | 300 V | 105° C | 0.945 (21.46) | 0.250 (6.35) | 0.303 (7.70) | .250 x .032 | Die Set C | 50 |
| NFIMT-14-250-P25 | 2 | 14-16 | 300 V | 105° C | 0.945 (24.00) | 0.250 (6.35) | 0.303 (7.70) | .250 x .032 | Die Set C | 50 |
| NFIMT-10-250-P25 | 2 | 10-12 | 300 V | 105° C | 0.984 (24.99) | 0.250 (6.35) | 0.303 (7.70) | .250 x .032 | Die Set C | 25 |
| NDFTD-10-250-P25 | | 10-12 | 600 V | 105° C | 0.925 (23.50) | 0.260 (6.60) | 0.295 (7.49) | .250 x .032 | Die Set B | 25 |

All wire sizes, unless noted otherwise, are American Wire Gauge (AWG)
Tested to UL 310, UL File E474613

Disconnect Terminals

Fully Insulated, Flag



TYPE ILSCONS

A1

Features

- Configuration of a right angle female disconnect
- Barrel allow for two crimps
- Funnel wire entry
- Nylon insulation
- Color coded
- Manufactured from high strength brass alloy
- Electro-tin plated
- Brazed barrel
- UL Listed for 600 volts, 105° C/221° F

Benefits

- Allows for multiple configurations where space is limited or when a conductor is square to the connector
- Stronger crimp connection that will not split open, prevents wire pull out
- Smooth wire insertion into barrel
- Increased heat and chemical resistant qualities for more demanding applications
- Provide easy wire range identification
- #18-22 AWG Red, #14-16 AWG Blue, #10-12 AWG Yellow
- Offers maximum conductivity
- Provides low contact resistance
- Provides strain relief, prevents exposure of wire conductors
- Ensures reliability for copper conductor

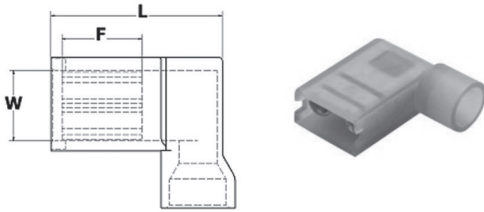

| Catalog Number | Wire Range | Dimensions - in. (mm) | | | Installation Tool ILST-22K | Package Quantity |
|---------------------------------------------|------------|-----------------------|--------------|--------------|-------------------------------|------------------|
| | | L | W | F | | |
| NFLB- Nylon-Insulated | | | | | | |
| NFLB-18-250-P25 | 18-22 | 0.598 (15.19) | 0.260 (6.60) | 0.299 (7.59) | Die Set FA | 25 |
| NFLB-14-250-P25 | 14-16 | 0.598 (15.19) | 0.260 (6.60) | 0.299 (7.59) | Die Set FA | 25 |
| NFLB-10-250-P25 | 10-12 | 0.650 (16.51) | 0.260 (6.60) | 0.299 (7.59) | Die Set FA | 25 |
| NFLBD- Nylon-Insulated- Double Crimp | | | | | | |
| NFLBD-18-187-P25 | 18-22 | 0.748 (19.00) | 0.197 (5.00) | 0.244 (6.20) | Die Set B | 25 |
| NFLBD-18-250-P25 | 18-22 | 0.819 (20.80) | 0.260 (6.60) | 0.295 (7.49) | Die Set B | 25 |
| NFLBD-14-187-P25 | 14-16 | 0.748 (19.00) | 0.197 (5.00) | 0.244 (6.20) | Die Set B | 25 |
| NFLBD-14-250-P25 | 14-16 | 0.819 (20.80) | 0.260 (6.60) | 0.295 (7.49) | Die Set B | 25 |
| NFLBD-10-250-P20 | 10-12 | 0.906 (23.01) | 0.260 (6.60) | 0.295 (7.49) | - | |

All wire sizes, unless noted otherwise, are American Wire Gauge (AWG)
Tested to UL 310, UL File E474613

Disconnect Terminals

Bullet

RoHS
Compliant



TYPE ILSCONS

Features

- Bullet configurations in standard sizes
- Barrel allows for two crimps - NBFTD, NBMTD
- Funnel wire entry
- Vinyl insulation - VBFT, VBMT, VFIBT
- Nylon insulation - NBFT, NBFTD, NBMT, NBMTD, NFIDT
- Color coded
- Manufactured from high strength brass alloy
- Electro-tin plated
- UL Recognized

Benefits

- Reliable, convenient in-line connection
- Provides strain relief of wire, prevents exposure of wire conductors
- Smooth wire insertion into barrel
- Provides corrosion resistance and strain relief
- Increased heat and chemical resistant qualities for more demanding applications
- Provide easy wire range identification
- #18-22 AWG Red, #14-16 AWG Blue, #10-12 AWG Yellow
- Offers maximum conductivity
- Provides low contact resistance
- Ensures reliability for brass conductor

A1

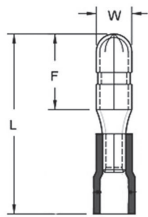

Fig. 1

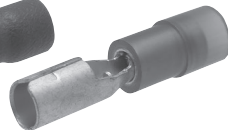

Fig. 2



Fig. 3



Fig. 4



Fig. 5



Fig. 6

| Catalog Number | Fig. No. | Wire Range | Voltage Rating | Temp Rating | Dimensions - in. (mm) | | | Commonly Mates With | Installation Tool ILST-22K | Pkg. Qty. |
|-----------------------------------------------------|----------|------------|----------------|--------------|-----------------------|--------------|---------------|---------------------|----------------------------|-----------|
| | | | | | L | W | F | | | |
| VBFT- Vinyl-Insulated- Female | | | | | | | | | | |
| VBFT-18-156-P50 | 1 | 18-22 | 300 V | 50° C/122° F | 0.846 (21.49) | 0.154 (3.91) | 0.276 (7.01) | VBMT-18-156-P50 | Die Set C | 50 |
| VBFT-14-156-P50 | 1 | 14-16 | 300 V | 50° C/122° F | 0.846 (21.49) | 0.154 (3.91) | 0.276 (7.01) | VBMT-14-156-P50 | Die Set C | 50 |
| VBFT-10-195-P25 | 1 | 10-12 | 300 V | 50° C/122° F | 0.965 (24.51) | 0.193 (4.90) | 0.276 (7.01) | VBMT-10-195-P25 | Die Set C | 25 |
| NBFT- Nylon-Insulated- Female | | | | | | | | | | |
| NBFT-18-156-P50 | 1 | 18-22 | 600 V | 85° C/185° F | 0.886 (22.50) | 0.154 (3.91) | 0.276 (7.01) | NBMT-18-156-P50 | Die Set C | 50 |
| NBFT-14-156-P50 | 1 | 14-16 | 600 V | 85° C/185° F | 0.886 (22.50) | 0.154 (3.91) | 0.276 (7.01) | NBMT-14-156-P50 | Die Set C | 50 |
| NBFT-10-195-P25 | 1 | 10-12 | 600 V | 85° C/185° F | 0.965 (24.51) | 0.193 (4.90) | 0.276 (7.01) | NBMT-10-195-P25 | Die Set C | 25 |
| NBFTD- Nylon-Insulated- Female- Double Crimp | | | | | | | | | | |
| NBFTD-18-156-P50 | 2 | 18-22 | 300 V | 85° C/185° F | 0.886 (22.50) | 0.154 (3.91) | 0.276 (7.01) | NBMTD-18-156-P50 | Die Set B | 50 |
| NBFTD-14-156-P50 | 2 | 14-16 | 300 V | 85° C/185° F | 0.886 (22.50) | 0.154 (3.91) | 0.276 (7.01) | NBMTD-14-156-P50 | Die Set B | 50 |
| NBFTD-10-195-P25 | 2 | 10-12 | 300 V | 85° C/185° F | 0.965 (24.51) | 0.193 (4.90) | 0.276 (7.01) | NBMTD-10-195-P25 | Die Set B | 25 |
| VFIBT- Vinyl-Fully-Insulated-Female | | | | | | | | | | |
| VFIBT-18-156-P50 | 3 | 18-22 | 300 V | 50° C/122° F | 0.906 (23.01) | 0.154 (3.91) | 0.276 (7.01) | NFIDT-18-156-P50 | Die Set C | 50 |
| VFIBT-14-156-P50 | 3 | 14-16 | 300 V | 50° C/122° F | 0.925 (23.50) | 0.154 (3.91) | 0.276 (7.01) | NFIDT-14-156-P50 | Die Set C | 50 |
| VFIBT-10-195-P25 | 3 | 10-12 | 300 V | 50° C/122° F | 0.945 (24.00) | 0.193 (4.90) | 0.276 (7.01) | N/A | Die Set C | 25 |
| VBMT- Vinyl-Insulated-Male | | | | | | | | | | |
| VBMT-18-156-P50 | 4 | 18-22 | 300 V | 50° C/122° F | 0.827 (21.01) | 0.157 (3.99) | 0.335 (8.51) | VBFT-18-156-P50 | Die Set C | 50 |
| VBMT-14-156-P50 | 4 | 14-16 | 300 V | 50° C/122° F | 0.827 (21.01) | 0.157 (3.99) | 0.335 (8.51) | VBFT-14-156-P50 | Die Set C | 50 |
| VBMT-10-195-P25 | 4 | 10-12 | 300 V | 50° C/122° F | 0.925 (23.50) | 0.197 (5.00) | 0.335 (8.51) | VBFT-10-195-P25 | Die Set C | 25 |
| NBMT- Nylon-Insulated-Male | | | | | | | | | | |
| NBMT-18-156-P50 | 4 | 18-22 | 600 V | 85° C/185° F | 0.866 (22.00) | 0.157 (3.99) | 0.335 (8.51) | NBFT-18-156-P50 | Die Set C | 50 |
| NBMT-14-156-P50 | 4 | 14-16 | 600 V | 85° C/185° F | 0.866 (22.00) | 0.157 (3.99) | 0.335 (8.51) | NBFT-14-156-P50 | Die Set C | 50 |
| NBMT-10-195-P25 | 4 | 10-12 | 600 V | 85° C/185° F | 0.925 (23.50) | 0.197 (5.00) | 0.335 (8.51) | NBFT-10-195-P25 | Die Set C | 25 |
| NBMTD- Nylon-Insulated-Male-Double Crimp | | | | | | | | | | |
| NBMTD-18-156-P50 | 5 | 18-22 | 300 V | 85° C/185° F | 0.866 (22.00) | 0.157 (3.99) | 0.335 (8.51) | NBFTD-18-156-P50 | Die Set B | 50 |
| NBMTD-14-156-P50 | 5 | 14-16 | 300 V | 85° C/185° F | 0.866 (22.00) | 0.157 (3.99) | 0.335 (8.51) | NBFTD-14-156-P50 | Die Set B | 50 |
| NBMTD-10-195-P25 | 5 | 10-12 | 300 V | 85° C/185° F | 0.925 (23.50) | 0.197 (5.00) | 0.335 (8.51) | NBFTD-10-195-P25 | Die Set B | 25 |
| NFIDT- Nylon-Fully-Insulated-Male | | | | | | | | | | |
| NFIDT-18-156-P25 | 6 | 18-22 | 600 V | 85° C/185° F | 1.063 (27.00) | 0.157 (3.99) | 0.413 (10.49) | VFIBT-18-156-P50 | Die Set C | 25 |
| NFIDT-14-156-P25 | 6 | 14-16 | 600 V | 85° C/185° F | 1.063 (27.00) | 0.157 (3.99) | 0.413 (10.49) | VFIBT-14-156-P50 | Die Set C | 25 |

All wire sizes, unless noted otherwise, are American Wire Gauge (AWG)
Tested to UL 1977, UL File E474615

Pin Terminals

Insulated



TYPE ILSCONS

A1

Features

- Solid pin design
- Funnel wire entry
- Barrel allows for two crimps - NPBRD
- Vinyl insulation - VPBR
- Nylon insulation - NPBR, NPBRD
- Color coded
- Manufactured from high strength copper alloy
- Electro-tin plated
- Brazed barrel
- UL Listed, 600 volts, 105° C/221° F

Benefits

- Provides an easy and effective way to terminate stranded wire into European/metric-style terminal blocks
- Smooth wire insertion into barrel
- Provides strain relief, prevents exposure of wire conductors
- Provides corrosion resistance and strain relief
- Increased heat and chemical resistant qualities for more demanding applications
- Provide easy wire range identification
- #18-22 AWG Red, #14-16 AWG Blue, #10-12 AWG Yellow
- Offers maximum conductivity
- Provides low contact resistance
- Stronger crimp connection to prevent wire pull-out
- Ensures reliability for copper conductor

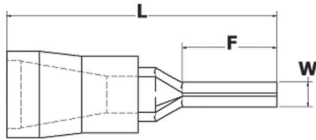

Fig. 1



Fig. 2

| Catalog Number | Fig. No. | Wire Range | Dimensions - in. (mm) | | | Installation Tool ILST-22K | Package Quantity |
|----------------------------------------------|----------|------------|-----------------------|--------------|---------------|-------------------------------|------------------|
| | | | L | W | F | | |
| VPBR- Vinyl Insulated | | | | | | | |
| VPBR-18-512-P50 | 1 | 18-22 | 0.898 (22.81) | 0.075 (1.91) | 0.512 (13.00) | Die Set A | 50 |
| VPBR-14-512-P50 | 1 | 14-16 | 0.898 (22.81) | 0.075 (1.91) | 0.512 (13.00) | Die Set A | 50 |
| VPBR-10-551-P25 | 1 | 10-12 | 1.063 (27.00) | 0.110 (2.79) | 0.551 (14.00) | Die Set A | 25 |
| NPBR- Nylon- Insulated | | | | | | | |
| NPBR-18-512-P50 | 1 | 18-22 | 0.937 (23.80) | 0.075 (1.91) | 0.512 (13.00) | Die Set A | 50 |
| NPBR-14-512-P50 | 1 | 14-16 | 0.937 (23.80) | 0.075 (1.91) | 0.512 (13.00) | Die Set A | 50 |
| NPBR-10-551-P25 | 1 | 10-12 | 1.063 (27.00) | 0.110 (2.79) | 0.551 (14.00) | Die Set A | 25 |
| NPBRD- Nylon- Insulated- Double Crimp | | | | | | | |
| NPBRD-18-512-P50 | 2 | 18-22 | 0.937 (23.80) | 0.075 (1.91) | 0.512 (13.00) | Die Set B | 50 |
| NPBRD-14-512-P50 | 2 | 14-16 | 0.937 (23.80) | 0.075 (1.91) | 0.512 (13.00) | Die Set B | 50 |
| NPBRD-10-551-P25 | 2 | 10-12 | 1.063 (27.00) | 0.110 (2.79) | 0.551 (14.00) | Die Set B | 25 |

All wire sizes, unless noted otherwise, are American Wire Gauge (AWG)
Tested to UL 486A/B, UL File E6207

Non-Insulated Splices

RoHS
Compliant

UL
LISTED
8M24



TYPE ILSCONS

Features

- Manufactured from high strength copper alloy
- Electro-tin plated

Benefits

- Provides maximum conductivity
- Provides low contact resistance

A1



Fig. 1

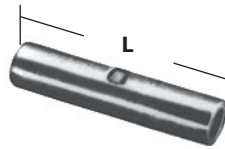

Fig. 2

| Catalog Number | Figure Number | Wire Range | L |
|----------------|---------------|------------|------|
| 44630-B10 | 1 | 8 | .38 |
| 44640-B10 | 1 | 6 | .46 |
| 44650-B10 | 1 | 4 | .54 |
| 44830-B10 | 2 | 8 | .77 |
| 44840-B10 | 2 | 6 | 1.02 |
| 44850-B10 | 2 | 4 | 1.20 |

All wire sizes, unless noted otherwise, are American Wire Gauge (AWG)
Can be supplied in bulk. Consult factory for part number.

UL File E158587

Vinyl Insulated Splices

RoHS
Compliant

UL
LISTED
8M24



TYPE ILSCONS

A1

Features

- Color coded
- Manufactured from high strength copper alloy
- Electro-tin plated
- Silver solder brazed seam
- Vinyl insulation
- UL Listed and CSA Certified for 600 volts, 90° C/194° F

Benefits

- Provides easy wire range identification
- #22-18 AWG Red, #16-14 AWG Blue, #12-10 AWG Yellow
- Provides maximum conductivity
- Provides low contact resistance
- May be crimped anywhere and will not split open, even under extreme operating stresses
- Provides tough pliable insulative qualities to protect connectors and wire from corrosion as well as providing some strain relief
- Ensures reliability for copper conductor



Fig. 1

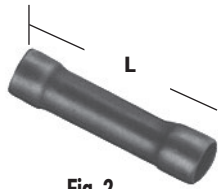

Fig. 2

| Catalog Number | Figure Number | Wire Range | L | Maximum Wire Insulated Diameter | Connector Type |
|----------------|---------------|------------|------|---------------------------------|-----------------|
| 44730-B5 | 1 | 8 | 1.05 | .385 | Parallel Splice |
| 44740-B5 | 1 | 6 | 1.19 | .440 | Parallel Splice |
| 44750-B5 | 1 | 4 | 1.41 | .515 | Parallel Splice |
| 44930-B5 | 2 | 8 | 1.46 | .385 | Butt Splice |
| 44940-B5 | 2 | 6 | 1.80 | .440 | Butt Splice |
| 44950-B5 | 2 | 4 | 1.95 | .515 | Butt Splice |

All wire sizes, unless noted otherwise, are American Wire Gauge (AWG)
Can be supplied in bulk. Consult factory for part number.

UL File E158587

TYPE ILSCONS

Features

- Butted configuration
- Internal wire stops
- Funnel wire entry
- Vinyl Insulation - VBST, VBSS
- Nylon Insulation - NBSS
- Color coded
- Manufactured from high strength copper alloy
- Electro-tin plated
- Seamless barrel - VBSS, NBSS
- UL Listed, see ratings in chart below

Benefits

- Provides fast, easy wire insertion in limited space applications, simply strip and crimp
- Ensures proper insertion length
- Smooth wire insertion into barrel
- Provides corrosion resistance and strain relief
- Increased heat and chemical resistant qualities for more demanding applications
- Provide easy wire range identification
- #18-22 AWG Red, #14-16 AWG Blue, #10-12 AWG Yellow
- Offers maximum conductivity
- Provides low contact resistance
- Maximum crimp connection to prevent wire pull-out
- Ensures reliability for copper conductor

A1

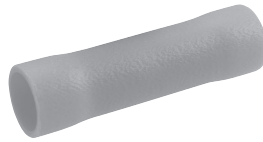

| Catalog Number | Wire Range | Voltage Rating | Temp. Rating | Length - in. (mm) | Installation Tool ILST-22K | Package Quantity |
|----------------------------------------|------------|----------------|--------------|-------------------|-------------------------------|------------------|
| VBST- Vinyl-Insulated- Butted | | | | | | |
| VBST-18-P50 | 18-22 | 600 V | 75° C/167° F | 0.969 (24.61) | Die Set A | 50 |
| VBST-14-P50 | 14-16 | 600 V | 75° C/167° F | 0.969 (24.61) | Die Set A | 50 |
| VBST-10-P25 | 10-12 | 600 V | 75° C/167° F | 1.043 (26.49) | Die Set A | 25 |
| VBSS- Vinyl-Insulated- Seamless | | | | | | |
| VBSS-18-P50 | 18-22 | 600 V | 75° C/167° F | 0.953 (24.21) | Die Set A | 50 |
| VBSS-14-P50 | 14-16 | 600 V | 75° C/167° F | 0.953 (24.21) | Die Set A | 50 |
| VBSS-10-P25 | 10-12 | 600 V | 75° C/167° F | 1.024 (26.01) | Die Set A | 25 |
| NBSS- Nylon-Insulated- Seamless | | | | | | |
| NBSS-18-P50 | 18-22 | 600 V | 105° C | 0.992 (25.20) | Die Set A | 50 |
| NBSS-14-P50 | 14-16 | 600 V | 105° C | 0.992 (25.20) | Die Set A | 50 |
| NBSS-10-P25 | 10-12 | 600 V | 105° C | 1.110 (28.19) | Die Set A | 25 |

All wire sizes, unless noted otherwise, are American Wire Gauge (AWG)
Tested to UL 486A/B, UL File E6207

nVent ILSCO Cool Seal Splices

Sealed; Insulated

RoHS
Compliant



TYPE ILSCONS

A1

Features

- Butted configuration
- Uses an innovative anaerobic encapsulated sealant that is heatless and solderless
- Locks out moisture and air
- Nylon insulation
- Manufactured from high strength copper alloy
- Seamless barrel
- Color coded
- UL Listed for 600 volts, 105° C/221° F

Benefits

- Provides fast, easy wire insertion in limited space applications, simply strip and crimp
- An environmentally sealed connection which can be installed in a fraction of the time of comparable heat seal connectors
- Prevents corrosion
- Increased puncture, heat and chemical resistant qualities for more demanding applications
- Provides maximum conductivity
- Maximum crimp connection to prevent wire pull-out
- Provide easy wire range identification
- #18-22 AWG Red, #14-16 AWG Blue, #10-12 AWG Yellow
- Ensures reliability for copper conductor



| Catalog Number | Wire Range | Length - in. (mm) | Installation Tool ILST-22K | Package Quantity |
|----------------|------------|-------------------|-------------------------------|------------------|
| CSBS-18-P50 | 18-22 | 1.000 (25.40) | Die Set A | 50 |
| CSBS-14-P50 | 14-16 | 1.031 (26.19) | Die Set A | 50 |
| CSBS-10-P25 | 10-12 | 1.500 (38.10) | Die Set A | 25 |

All wire sizes, unless noted otherwise, are American Wire Gauge (AWG)
Tested to UL 486 C, UL File E6207

TYPE
94130
Controlled-Cycle
Crimper

- Features**
- Dieless tool
 - Ratchet mechanism
 - Compound action
 - Cushion grip handles
 - Crimps insulated wire terminals
 - Wire Range: 10-22 AWG, Weight .8 lb

- Benefits**
- No need to purchase and maintain dies
 - Assures proper crimp force every time
 - Delivers maximum crimp force with minimum effort
 - Provides user comfort
 - Provides flexibility in use

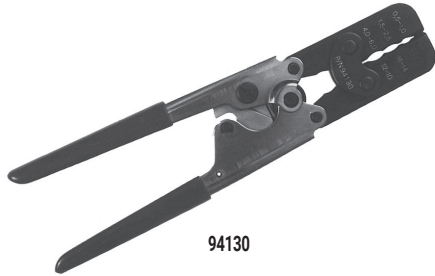

94130

A1

TYPE
94145
Multi Purpose
Crimp Tool





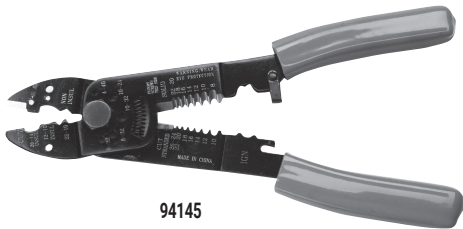



- Features**
- Heavy duty carbon steel construction
 - Comfort grip handles
 - Spring loaded action
 - Safety lock mechanism
 - Color coded crimp nest
 - Crimp nest
 - Wire cutter
 - Machine screw cutters
 - Wire stripper/wire gauge

- Benefits**
- Provides durable rugged reliability
 - Provides user comfort
 - Enables multiple crimps
 - Provides for compact storage
 - For insulated terminals
 - For uninsulated terminals
 - Easily cuts solid and stranded wire
 - Cuts and rethreads 4-40, 6-32, 8-32, 10-24, and 10-32 machine screws
 - 26-8 AWG

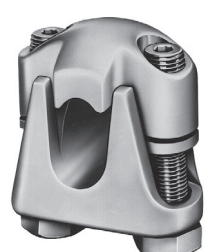

94145

Split Bolts

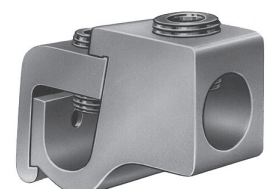
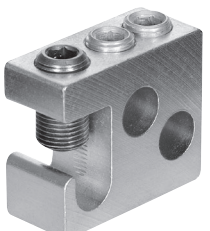
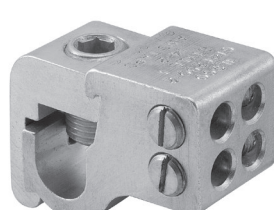
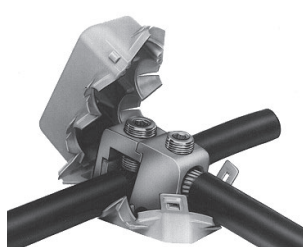
| | | |
|-------------------------------------------------------------------------------------------------------------------------|-------------------------------------------------------------------------------------------------------------------|----------------------------------------------------------------------------------------------------------------------------|
| <p>IK</p>  <p>128-129</p> | <p>IK3</p>  <p>130</p> | <p>SK</p>  <p>131</p> |
| <p>IKB</p>  <p>132</p> | <p>IKS</p>  <p>133</p> | <p>AK</p>  <p>134</p> |
| <p>DBA, DBA-S</p>  <p>135</p> | <p>IPC</p>  <p>136</p> | <p>GTT</p>  <p>137</p> |
| <p>GT2</p>  <p>138</p> | <p>GT4T</p>  <p>139</p> | <p>GTA/GTT KIT</p>  <p>140</p> |

Copper Split Bolts

RoHS
Compliant

UL
LISTED
460C

SA
701570

TYPE IK

Features

- Manufactured from high strength copper alloy
- Precision tooled threads
- UL 467 Listed for Grounding and Bonding 500kcmil thru 8
- CSA Certified for Grounding and Bonding 250kcmil thru 8
- RUS Accepted 8 thru 1/0 AWG
- For use with copper conductor types: Solid, Compact, Compressed, Concentric
- Suitable for use in circuits rated 35KV or less, proper high voltage spacing and insulation techniques must be used
- Rated to 90° C/194° F

Benefits

- Provides maximum conductivity and high breakage resistance
- Allows maximum torque to be applied
- Suitable for direct burial in earth and concrete
- Application versatility

B

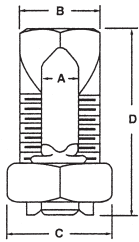

| Catalog Number | Range for Equal Tap & Main | Min. tap with One Max. Main | Max. Cond Copperweld | | Rebar With 6 or 8 AWG | Wire Diameter | Dimensions (in.) | | | | Recommended Torque (IN-LB) |
|----------------|----------------------------|-----------------------------|----------------------|--------|-----------------------|---------------|------------------|-------|-------|-------|----------------------------|
| | | | Str | Type A | | | A | B | C | D | |
| IK-2/0 | 2/0str - 2sol | 14str | 3 No. 5 | - | #3 (3/8) | .258 - .418 | .420 | 0.812 | 1.000 | 1.812 | 385 |
| IK-3/0 | 3/0str - 2sol | 12sol | 7 No. 7 | - | N/A | .258 - .470 | 0.466 | 0.875 | 1.125 | 2.000 | 500 |
| IK-250 | 250kcmil - 1/0sol | 10sol | 7 No. 5 | - | #4 (1/2) | .325 - .575 | 0.579 | 1.000 | 1.312 | 2.078 | 650 |
| IK-350 | 350kcmil - 4/0str | 8sol | 19 No. 7 | - | #5 (5/8) | .528 - .682 | 0.746 | 1.500 | 1.625 | 2.625 | 650 |
| IK-500 | 500kcmil - 250kcmil | 8sol | 19 No. 6 | - | #6 (3/4) | .575 - .815 | 0.834 | 1.625 | 1.812 | 3.000 | 825 |
| IK-750 | 750kcmil - 350kcmil | 8sol | 19 No. 5 | - | N/A | .682 - .999 | 1.030 | 1.938 | 2.125 | 3.750 | 1000 |
| IK-1000 | 1000kcmil - 500kcmil | 8sol | - | - | N/A | .815 - 1.153 | 1.222 | 2.250 | 2.500 | 4.000 | 1100 |

All wire sizes, unless noted otherwise, are American Wire Gauge (AWG)
UL File E6207

TYPE IK-N

Features

- Manufactured from high strength copper alloy
- Precision tooled threads
- UL 486 A/B Listed for Power; Certified to CSA C22.2 No. 65
- UL 467 Listed for Grounding and Bonding; Certified to CSA C22.2 No. 41
- Unique design on pressure pad for added secureness
- For use with copper conductor types: Solid, Compact, Compressed, Concentric
- Suitable for use in circuits rated 35KV or less, proper high voltage spacing and insulation techniques must be used
- Rated to 90° C/194° F

Benefits

- Provides maximum conductivity and high breakage resistance
- Allows maximum torque to be applied
- Suitable for direct burial in earth and concrete
- Application versatility

B

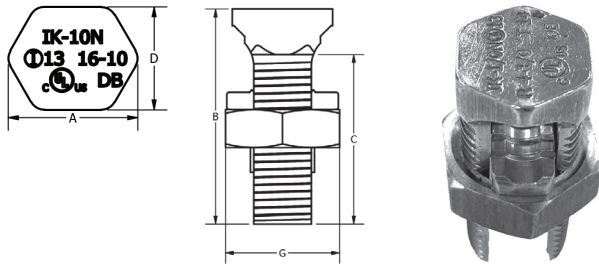

| Catalog Number | Range for Equal Tap & Main | Min. tap with One Max. Main | Dimensions (in.) | | | | | Recommended Torque (IN-LB) |
|----------------|----------------------------|-----------------------------|------------------|-------|-------|-------|-------|----------------------------|
| | | | A | B | C | D | G | |
| IK-10N | 10str - 16str | 16str | 0.425 | 0.810 | 0.602 | 0.340 | 0.500 | 80 |
| IK-8N | 8str - 16str | 16str | 0.500 | 0.850 | 0.630 | 0.380 | 0.500 | 80 |
| IK-6N | 6sol - 10sol | 16sol | 0.550 | 1.050 | 0.768 | 0.500 | 0.630 | 165 |
| IK-4N | 4sol - 8sol | 16sol | 0.619 | 1.050 | 0.768 | 0.560 | 0.690 | 165 |
| IK-3N | 2sol - 6sol | 12sol | 0.673 | 1.500 | 1.181 | 0.600 | 0.750 | 275 |
| IK-2N | 2str - 6sol | 14str | 0.762 | 1.320 | 1.004 | 0.690 | 0.820 | 275 |
| IK-1/0N | 1/0str - 4sol | 14sol | 0.836 | 1.770 | 1.398 | 0.730 | 0.940 | 385 |

All wire sizes, unless noted otherwise, are American Wire Gauge (AWG)
UL File E6207

Three Wire Copper Split Bolts

RoHS
Compliant

UL
LISTED
460C

SA
701570

TYPE IK3

Features

- Manufactured from high strength copper alloy
- Precision tooled threads
- UL 467 Listed and CSA Certified for Grounding and Bonding
- RUS Accepted
- For use with copper conductor types: Solid, Compact, Compressed, Concentric
- Suitable for use in circuits rated 35KV or less, proper high voltage spacing and insulation techniques must be used
- Rated to 90° C/194° F

Benefits

- Provides maximum conductivity and high breakage resistance
- Allows maximum torque to be applied
- Suitable for direct burial in earth and concrete
- Application versatility

B

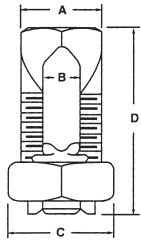

| Catalog Number | Range for Equal Tap & Main | Min. tap with One Max. Main | Max. Cond Copperweld | | Wire Diameter Range | Dimensions (in.) | | | | Recommended Torque (IN-LB) |
|----------------|----------------------------|-----------------------------|----------------------|--------|---------------------|------------------|-------|-------|-------|----------------------------|
| | | | Str | Type A | | A | B | C | D | |
| IK3-8 | 8str - 16str | 16str | - | - | .057 - .145 | 0.144 | 0.375 | 0.500 | 0.844 | 80 |
| IK3-6 | 6sol - 10sol | 16sol | - | - | .102 - .162 | 0.166 | 0.500 | 0.625 | 1.109 | 165 |
| IK3-4 | 4sol - 8sol | 16sol | 3 No. 12 | 8A | .128 - .204 | 0.217 | 0.562 | 0.688 | 1.266 | 165 |
| IK3-2 | 2str - 6sol | 14str | 3 No. 7 | 3A | .162 - .258 | 0.326 | 0.688 | 0.812 | 1.547 | 275 |

All wire sizes, unless noted otherwise, are American Wire Gauge (AWG)
UL File E6207

Tin Plated Copper Split Bolts

RoHS
Compliant

UL
LISTED
460C

SA
701570

TYPE
SK

Features

- Manufactured from high strength copper alloy
- Electro-tin plated bolt, nut, spacer and pressure bar
- Precision tooled threads
- SK-10, SK-8, SK3, SK-2 SK-1/0, SK-2/0 are RUS Accepted
- For use with copper conductor types: Solid, Compact, Compressed, Concentric
- Suitable for use in circuits rated 35KV or less, proper high voltage spacing and insulation techniques must be used
- Rated to 90° C/194° F

Benefits

- Provides maximum conductivity and high breakage resistance
- Provides low contact resistance
- Application versatility

B

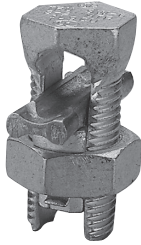
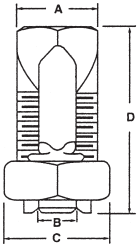

| Catalog Number | Range for Equal Tap & Main | Min. tap with One Max. Main | Max. Cond Copperweld | | Wire Diameter Range | Dimensions (in.) | | | | Recommended Torque (IN-LB) |
|----------------|----------------------------------|-----------------------------|----------------------|--------|---------------------|------------------|-------|-------|-------|----------------------------|
| | | | Str | Type A | | A | B | C | D | |
| SK-10 | 10str - 16str | 16str | - | - | .057 - .116 | .144 | 0.375 | 0.500 | 0.844 | 80 |
| SK-8 | 8str - 16str | 16str | - | - | .057 - .145 | 0.144 | 0.375 | 0.500 | 0.844 | 80 |
| SK-6 + | 8str - 14str | 14str | - | - | .073 - .146 | .166 | 0.500 | 0.625 | 1.109 | 165 |
| SK-4 + | 6str - 10str | 10sol | 3 No. 12 | 8A | .116 - .184 | 0.217 | 0.562 | 0.688 | 1.266 | 165 |
| SK-3 + | 4str - 8sol AL 2sol - 8sol CU | 8sol AL 8sol CU | 3 No. 9 | 5A | .128 - .258 | 0.326 | 0.688 | 0.812 | 1.547 | 275 |
| SK-2 + | 2str - 8sol | 8sol | 3 No. 7 | 3A | .128 - .316 | 0.326 | 0.688 | 0.812 | 1.547 | 275 |
| SK-1/0 | 1/0str - 6sol | 10sol | 3 No. 6 | - | .162 - .375 | 0.376 | 0.750 | 0.875 | 1.641 | 385 |
| SK-2/0 | 2/0str - 6str | 10sol | 3 No. 5 | - | .184 - .419 | .420 | 0.812 | 1.000 | 1.812 | 385 |
| SK-3/0 | 3/0str - 4str | 6sol | 7 No. 7 | - | .198 - .470 | 0.466 | 0.875 | 1.125 | 2.000 | 500 |
| SK-250 | 250kcmil - 4str | 4str | 7 No. 5 | - | .232 - .575 | 0.577 | 1.000 | 1.312 | 2.328 | 650 |
| SK-350 | 350kcmil - 3/0str | 1sol | 19 No. 7 | - | .447 - .682 | 0.746 | 1.500 | 1.625 | 2.625 | 650 |
| SK-500 | 500kcmil - 3/0str | 1/0str | 19 No. 6 | - | .447 - .815 | 0.834 | 1.625 | 1.812 | 3.000 | 825 |
| SK-750 | 750kcmil - 50kcmil | 2/0str | 19 No. 5 | - | .563 - .999 | 1.030 | 1.938 | 2.125 | 3.750 | 1000 |
| SK-1000 | 1000kcmil - 350kcmil | 4/0str | - | - | .682 - 1.162 | 1.222 | 2.250 | 2.500 | 4.000 | 1100 |

All wire sizes, unless noted otherwise, are American Wire Gauge (AWG)

+ AL9CU

UL File E12822

Copper Two Bolt Connectors

TYPE IKB

Features

- Manufactured from high strength copper alloy
- Two bolt design
- Longer peened bolt
- Suitable for use in circuits rated 35KV or less, proper high voltage spacing and insulation techniques must be used
- For copper conductor only
- Rated to 90° C/194° F

Benefits

- Allows maximum conductivity and high breakage resistance
- Allows maximum pressure to be applied directly to the conductor strands
- Permits a swivel action for easier installation
- Application versatility

B

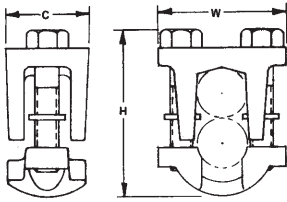

| Catalog Number | Copper Wire Range | | Dimensions (in.) | | |
|----------------|--------------------|---------------|------------------|------|------|
| | Main | Tap | C | H | W |
| IKB-4/0 + | 1/0-4/0 | 4/0-10 | 1.10 | 1.97 | 1.72 |
| IKB-350 + | 350kcmil-250kcmil | 350kcmil-10 | 1.38 | 2.48 | 2.14 |
| IKB-500 | 500kcmil-400kcmil | 500kcmil-10 | 1.50 | 2.80 | 2.25 |
| IKB-800 | 800kcmil-400kcmil | 800kcmil-3/0 | 1.62 | 3.32 | 2.50 |
| IKB-1000 | 1000kcmil-500kcmil | 1000kcmil-3/0 | 2.00 | 3.78 | 3.03 |

All wire sizes, unless noted otherwise, are American Wire Gauge (AWG)
+ RUS Listed
Tested to UL 486A/B, UL File E6207

Two Bolt Connectors

TYPE IKS

Features

- Manufactured from high strength copper alloy
- Electro-tin plated
- Two bolt design
- Longer peened bolt
- Serrated spacer bar
- For copper conductor only

Benefits

- Allows maximum conductivity and high breakage resistance
- Provides low contact resistance
- Allows maximum pressure to be applied directly to the conductor strands
- Permits a swivel action for easier installation
- Makes a secure connection

B

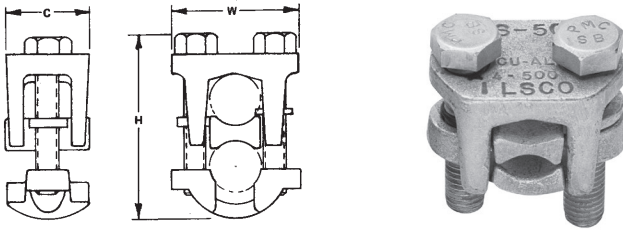

| Catalog Number | Copper Wire Range | | Dimensions (in.) | | |
|----------------|--------------------|---------------|------------------|------|------|
| | Main | Tap | C | H | W |
| IKS-4/0 | 4/0-1/0 | 4/0-6 | 1.12 | 2.31 | 1.72 |
| IKS-350 | 350kcmil-250kcmil | 350kcmil-6 | 1.38 | 2.62 | 2.12 |
| IKS-500 | 500kcmil-400kcmil | 500kcmil-4 | 1.50 | 3.00 | 2.26 |
| IKS-800 | 800kcmil-400kcmil | 800kcmil-4/0 | 1.62 | 3.50 | 2.50 |
| IKS-1000 | 1000kcmil-500kcmil | 1000kcmil-4/0 | 2.00 | 4.03 | 3.03 |

All wire sizes, unless noted otherwise, are American Wire Gauge (AWG)

Aluminum Split Bolt

Dual Rated

RoHS
Compliant

UL
LISTED
670B

SA
72632

TYPE
AK

Features

- Manufactured from heat treated aluminum alloy
- Triangular edges
- Suitable for use in circuits rated 35KV or less, proper high voltage spacing and insulation techniques must be used
- Electro-tin plated
- Spacer bar
- Hex Head
- Rated to 90° C/194° F

Benefits

- Provides maximum conductivity and strength for copper and aluminum conductors
- Bite into the conductor to break through surface oxides which eliminates wire brushing
- Application versatility
- Provides low contact resistance
- Separates dissimilar metals which prevents galvanic corrosion
- Provides ease of installation with standard wrenches

B

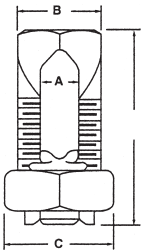

| Catalog Number | Copper Wire Range | | Recommended Tightening Torque | Dimensions (in.) | | |
|----------------|---------------------------|------------------------|-------------------------------|------------------|------|------|
| | Main | Tap | | B | C | D |
| AK-6 | 6 str-10 sol | 6 str-10 sol | 165 | .56 | .75 | 1.88 |
| AK-4 | 4 str-8 sol | 4 str-10 sol | 165 | .62 | .81 | 1.38 |
| AK-2 | 2 str-6 str Compact | 2 str-8 str | 275 | .69 | .94 | 1.58 |
| AK-1/0 | 1/0 str-2 str Compact | 1/0 str-8 str | 385 | .75 | 1.00 | 1.92 |
| AK-2/0 | 2/0 str-2 str Compact | 2/0 str-8 str | 385 | .88 | 1.12 | 1.92 |
| AK-4/0 | 4/0 str-2 str Compact | 4/0 str-6 str | 500 | 1.13 | 1.49 | 2.54 |
| AK-350 | 350kcmil-1/0 str Compact | 350kcmil-4 str | 650 | 1.50 | 1.69 | 3.24 |
| AK-500 | 500kcmil-400kcmil Compact | 500kcmil-2 str Compact | 825 | 1.73 | 2.00 | 3.62 |

All wire sizes, unless noted otherwise, are American Wire Gauge (AWG)

De-Ox Inhibitor is recommended for all aluminum terminations.

UL File E9998

Aluminum Two Bolt Connectors

Dual Rated



TYPE DBA DBA-S

Features

- Manufactured from high strength aluminum alloy
- Heat treated
- Wax plated
- Neoprene washers
- Range taking
- Re-usable
- Type DBA-S - Spacer bar

Benefits

- Type DBA - Suitable for copper to copper or aluminum to aluminum conductors
- Type DBA-S - Suitable for copper and/or aluminum conductors in any combination
- Provides maximum strength
- Provides low contact resistance
- Hold the bolts captive and eliminates the possibility of loose hardware
- Permits inventories to be kept to a minimum
- Provides efficient use and flexibility in the field
- Separates dissimilar metals

B

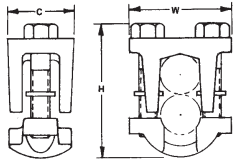

Fig. 1

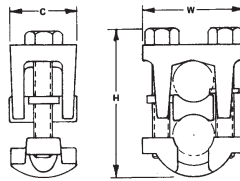
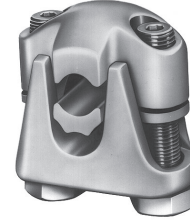

Fig. 2



| Catalog Number | Figure Number | Copper Wire Range | | Dimensions (in.) | | |
|----------------|---------------|--------------------|---------------|------------------|---------|-------|
| | | Main | Tap | C | H | W |
| DBA-2/0 | 1 | 2/0-2 | 2/0-10 | 1-1/8 | 1-5/8 | 1-5/8 |
| DBA-250 | 1 | 250kcmil-1/0 | 250kcmil-10 | 1-5/16 | 2 | 2 |
| DBA-350 | 1 | 350kcmil-4/0 | 350kcmil-10 | 1-9/16 | 2-11/32 | 2-1/4 |
| DBA-500 | 1 | 500kcmil-350kcmil | 500kcmil-10 | 1-3/4 | 2-1/2 | 2-3/4 |
| DBA-800 | 1 | 800kcmil-400kcmil | 800kcmil-3/0 | 1-7/8 | 2-7/8 | 3 |
| DBA-1000 | 1 | 1000kcmil-500kcmil | 1000kcmil-3/0 | 2-1/4 | 3-3/16 | 3-1/2 |
| DBA-2/0S | 2 | 2/0-2 | 2/0-10 | 1-1/8 | 1-5/8 | 1-5/8 |
| DBA-250S | 2 | 250kcmil-1/0 | 250kcmil-10 | 1-5/16 | 2 | 2 |
| DBA-350S | 2 | 350kcmil-4/0 | 350kcmil-10 | 1-9/16 | 2-11/32 | 2-1/4 |
| DBA-500S | 2 | 500kcmil-350kcmil | 500kcmil-10 | 1-3/4 | 2-1/2 | 2-3/4 |
| DBA-800S | 2 | 800kcmil-400kcmil | 800kcmil-3/0 | 1-7/8 | 2-7/8 | 3 |
| DBA-1000S | 2 | 1000kcmil-500kcmil | 1000kcmil-3/0 | 2-1/4 | 3-3/16 | 3-1/2 |

All wire sizes, unless noted otherwise, are American Wire Gauge (AWG)
De-Ox Inhibitor is recommended for all aluminum terminations.

nVent ILSCO KUP-L-Tap Insulation Piercing Connectors Dual Rated



TYPE
IPC



Features

- Body is molded from tough, resilient glass-filled nylon
- Compact design
- Tin plated copper contact teeth
- Insulation piercing
- Perforated end tabs
- Pre-filled with silicone lubricant
- Versatile
- Increased safety
- Horizontal line grid
- Temperature rating 90° C/194° F

Benefits

- Provides high degree of breakage resistance and long dependable use
- Saves space
- Easily penetrates most types of insulation
- No need to strip the conductor which saves installation time
- Break out easily by hand
- Prevents oxidation and moisture from entering the contact area
- Can be used as a splice or tap connector
- Contains no external energized parts. Can be installed "hot" on energized conductors providing tap conductor is not under load.
- Provides a visual guide for proper installation of conductors

B

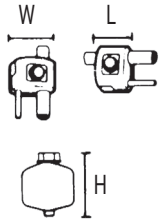

Fig. 1



Fig. 2



Fig. 3



Fig. 4

| Catalog Number | Figure Number | Wire Range | | Volts | Current Rating | | Dimensions (in.) | | | Torque Ft. Lbs. | Bolt Head Size |
|----------------|---------------|---------------------|-------------------|-----------------------------|----------------|-----|------------------|---------|---------|-----------------|----------------|
| | | Main | Tap | | CU | AL | L | W | H | | |
| IPC-1/0-2 | 3 | 1/0-8 | 2-8 | 300 (480 Grounded Y System) | 130 | 100 | 1-7/32 | 1-15/32 | 2-5/16 | 16 | 1/2 |
| IPC-4/0-6 | 2 | 4/0-4 | 6-14 | 600 | 75 | 60 | 1-27/64 | 1 | 1-7/8 | 13 | 1/2 |
| IPC-4/0-2/0 | 3 | 4/0-2 | 2/0-6 | 600 | 195 | 150 | 1-21/32 | 1-7/8 | 2-7/8 | 25 | 1/2 |
| IPC-250-4/0 | 2 | 250kcmil - 1 | 4/0-6 | 600 | 260 | 205 | 1-7/8 | 2-11/32 | 3-11/32 | 30 | 5/8 |
| IPC-350-4/0 | 3 | 350kcmil - 4/0 | 4/0-10 | 300 (480 Grounded Y System) | 260 | 205 | 1-43/64 | 2-7/16 | 3-1/8 | 25 | 5/8 |
| IPC-350-350 | 4 | 350kcmil - 4/0 | 350kcmil-4/0 | 300 (480 Grounded Y System) | 350 | 280 | 2-43/64 | 2-23/32 | 3-1/4 | 25 | 5/8 |
| IPC-500-12 | 1 | 500kcmil - 250kcmil | 10-12 | 300 (480 Grounded Y System) | 40 | 35 | 1-43/64 | 2-7/16 | 3-1/4 | 25 | 5/8 |
| IPC-500-250 | 1 | 500kcmil - 250kcmil | 250kcmil-4 | 600 | 290 | 230 | 2-27/64 | 2-29/32 | 3-3/4 | 55 | 5/8-11/16 |
| IPC-500-500 | 1 | 500kcmil - 300kcmil | 500kcmil-250kcmil | 600 | 430 | 350 | 3-3/16 | 3-5/8 | 5 | 75 | 7/8-7/8 |
| IPC-750-500 | 1 | 750kcmil - 500kcmil | 500kcmil-350kcmil | 600 | 430 | 350 | 3-3/16 | 3-5/8 | 5 | 75 | 7/8-7/8 |

All wire sizes, unless noted otherwise, are American Wire Gauge (AWG)
Tested to UL 486A/B, UL File E6207

Not for use with cloth insulated conductor type TCCW

"T" Tap Connectors

Dual Rated - Lay-In

RoHS
Compliant

UL
LISTED
453G

CSA
LR-29601

TYPE
GTT

Features

- Manufactured from high strength 6061-T6 aluminum alloy
- Electro-tin plated
- UL Listed and CSA Certified for 600 volts, 90° C/194° F
- Compact design
- Range taking
- Re-usable
- Lay-in main conductor
- Insulating cover available

Benefits

- Suitable for use with either copper or aluminum conductors
- Provides low contact resistance
- Ensures reliability for copper or aluminum conductors
- Saves space and reduces installation time
- Permits inventories to be kept to a minimum
- Provides efficient use and flexibility in the field
- No need to break the feeder cable
- Eliminates taping

B

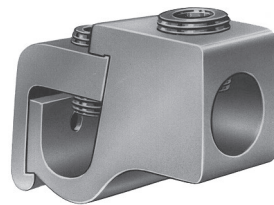
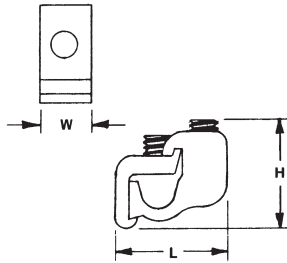

Fig. 1

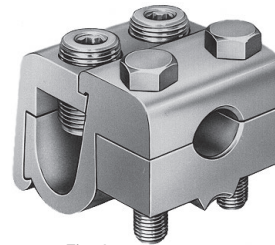
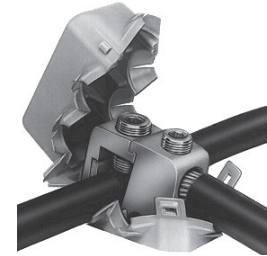

Fig. 2



| Catalog Number | Figure Number | Wire Range | | Dimensions (in.) | | | Hex Size Main | Tap |
|----------------|---------------|-------------------|---------------------|------------------|-------|---------|---------------|--------|
| | | Main | Tap | L | W | H | | |
| GTT-2-2 | 1 | 2-12 str | 2-12 AL 2-14 CU | 1-1/4 | 9/16 | 1 | Slot | Slot |
| GTT-0-0 | 1 | 1/0-2 | 1/0-12 AL 1/0-14 CU | 1-9/16 | 3/4 | 1-1/8 | Slot | Slot |
| GTT-250-0 | 1 | 250kcmil-1/0 | 1/0-12 AL 1/0-14 CU | 2 | 7/8 | 1-7/16 | 5/16 | Slot |
| GTT-250-250 | 1 | 250kcmil-1/0 | 250kcmil-6 | 2-1/8 | 7/8 | 1-7/16 | 5/16 | 5/16 |
| GTT-350-350 | 1 | 350kcmil-4/0 | 350kcmil-6 | 2-7/16 | 1 | 1-11/16 | 3/8 | 3/8 |
| GTT-500-500 | 1 | 500kcmil-350kcmil | 500kcmil-2 | 2-15/16 | 1-1/4 | 2 | 3/8 | 3/8 |
| GTT-750-500 | 1 | 750kcmil-500kcmil | 500kcmil-2 | 3-3/8 | 1-1/4 | 2-7/16 | 3/8 | 3/8 |
| GTT-750-750 | 2 | 750kcmil-500kcmil | 750kcmil-600kcmil | 3-3/8 | 2-3/8 | 2-7/16 | 1/2 | EH 3/4 |

Note: If ordering with cover, add suffix W/C to catalog number.

All wire sizes, unless noted otherwise, are American Wire Gauge (AWG)

EH-External Hex

Insulating covers are available for most connector sizes.

De-Ox Inhibitor is recommended for all aluminum terminations.

Tested to UL 486A/B, UL File E6207

Multiple Tap Connector

Dual Rated - Lay-In



TYPE GT2

Features

- Manufactured from high strength 6061-T6 aluminum alloy
- Electro-tin plated
- UL Listed for 600 volts, 90° C/194° F
- Compact design
- Range taking
- Re-usable
- Lay-in main conductor
- Supplied with cover

Benefits

- Suitable for use with either copper or aluminum conductors
- Provides low contact resistance
- Ensures reliability for copper or aluminum conductors
- Saves space and reduces installation time
- Permits inventories to be kept to a minimum
- Provides efficient use and flexibility in the field
- No need to break the feeder cable
- Eliminates taping

B

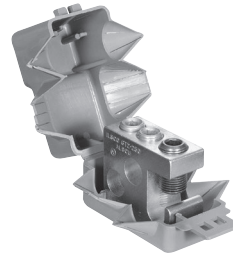
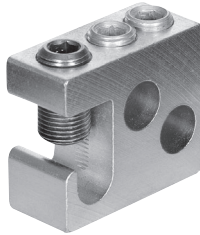
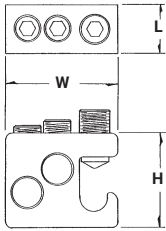

| Catalog Number | Wire Range Main & Tap | No. of Taps | Dimensions (in.) | | | Hex Size |
|----------------|-----------------------|-------------|------------------|--------|---------|----------|
| | | | L | W | H | |
| GT2-250-W/C | 250kcmil-2 | 2 | 31/32 | 2-9/32 | 1-15/16 | 5/16 |

All wire sizes, unless noted otherwise, are American Wire Gauge (AWG)

De-Ox Inhibitor is recommended for all aluminum terminations.

Tested to UL 486A/B, UL File E6207

Multiple Tap Connector

Dual Rated - Lay-In

RoHS
Compliant

UL
LISTED
453G

CSA
LR-29601

TYPE GT4T

Features

- Manufactured from high strength 6061-T6 aluminum alloy
- Electro-tin plated
- UL Listed and CSA Certified for 600 volts, 90° C/194° F
- Compact design
- Range taking
- Re-usable
- Lay-in main conductor
- Insulating cover available

Benefits

- Suitable for use with either copper or aluminum conductors
- Provides low contact resistance
- Ensures reliability for copper or aluminum conductors
- Can make up to four taps off a single main which saves space and reduces installation time
- Permits inventories to be kept to a minimum
- Provides efficient use and flexibility in the field
- No need to break the feeder cable
- Eliminates taping

B

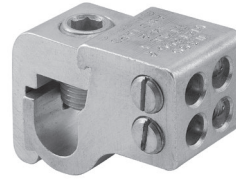
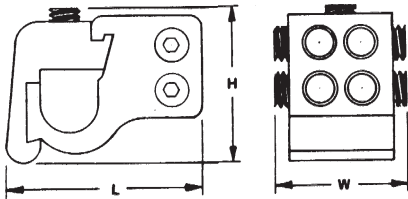

Fig. 1



Fig. 2

| Catalog Number | Figure Number | Wire Range | | No. of Taps | Dimensions (in.) | | | Hex Size | |
|----------------|---------------|-------------------|----------------------|-------------|------------------|-------|---------|----------|------|
| | | Main | Tap | | L | W | H | Main | Tap |
| GT4T-250-2-1* | 1 | 250kcmil-1/0 | 2-12 AL, 2-14 CU | 4 | 2-3/16 | 1-1/8 | 1-35/64 | 5/16 | Slot |
| GT4T-250-2-2* | 2 | 250kcmil-1/0 | 2-12 AL, 2-14 CU | 4 | 2-3/16 | 1-1/8 | 1-35/64 | 5/16 | Slot |
| GT4T-350-2-1† | 1 | 350kcmil-4/0 | 2-12 AL, 2-14 CU | 4 | 2-17/32 | 1-1/8 | 1-17/32 | 3/8 | Slot |
| GT4T-350-2-2* | 2 | 350kcmil-4/0 | 2-12 AL, 2-14 CU | 4 | 2-17/32 | 1-1/8 | 1-17/32 | 3/8 | Slot |
| GT4T-500-2-1† | 1 | 500kcmil-350kcmil | 2-12 AL, 2-14 CU | 4 | 2-31/32 | 1-1/4 | 1-11/16 | 3/8 | Slot |
| GT4T-500-2-2† | 2 | 500kcmil-350kcmil | 2-12 AL, 2-14 CU | 4 | 2-31/32 | 1-1/4 | 1-11/16 | 3/8 | Slot |
| GT4T-500-0-1† | 1 | 500kcmil-350kcmil | 1/0-12 AL, 1/0-14 CU | 4 | 2-31/32 | 1-1/4 | 1-11/16 | 3/8 | Slot |
| GT4T-500-0-2† | 2 | 500kcmil-350kcmil | 1/0-12 AL, 1/0-14 CU | 4 | 2-31/32 | 1-1/4 | 1-11/16 | 3/8 | Slot |

All wire sizes, unless noted otherwise, are American Wire Gauge (AWG)

* GTC-250-350 Cover can be used.

† GTC-500 can be used.

De-Ox Inhibitor is recommended for all aluminum terminations.

Tested to UL 486A/B, UL File E6207

Tap Connector Kits

Dual Rated



TYPE GTA/GTT KITS

Features

- Kit includes connector, cover and 5cc De-Ox tube
- Manufactured from high strength aluminum alloy
- Cover has snap closure
- UL Listed and CSA Certified for 600 volts, 90° C/194° F

Benefits

- Saves time, convenient
- Suitable for use with copper or aluminum conductors
- Installs quickly, eliminates taping
- Ensures reliability

B

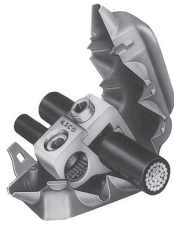

Fig. 1

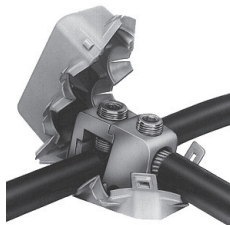

Fig. 2

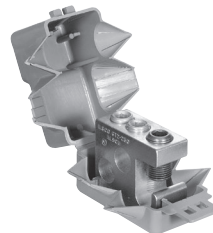

Fig. 3

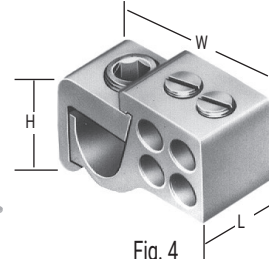

Fig. 4

| Catalog Number | Figure Number | Wire Range | | No. of Taps | Dimensions (in.) | | | Hex Size | |
|------------------|---------------|--------------|----------------------|-------------|------------------|--------|---------|----------|------|
| | | Main | Tap | | L | W | H | Main | Tap |
| GTA-0-0-W/C | 1 | 1/0-2 | 1/0-12 AL, 1/0-14 CU | 1 | 3/4 | 1-7/16 | 1-1/8 | Slot | Slot |
| GTA-2-2-W/C | 1 | 2-12 | 2-12 AL, 2-14 CU | 1 | 9/16 | 1-1/8 | 1 | Slot | Slot |
| GTA-250-0-W/C | 1 | 250kcmil-1/0 | 1/0-12 AL, 1/0-14 CU | 1 | 7/8 | 2 | 1-7/16 | 5/16 | Slot |
| GTA-250-250-W/C | 1 | 250kcmil-1/0 | 250kcmil-6 | 1 | 7/8 | 2 | 1-7/16 | 5/16 | 5/16 |
| GTT-0-0-W/C | 2 | 1/0-2 | 1/0-12 AL, 1/0-14 CU | 1 | 3/4 | 1-9/16 | 1-1/8 | Slot | Slot |
| GTT-2-2-W/C | 2 | 2-12 | 2-12 AL, 2-14 CU | 1 | 9/16 | 1-1/4 | 1 | Slot | Slot |
| GTT-250-0-W/C | 2 | 250kcmil-1/0 | 1/0-12 AL, 1/0-14 CU | 1 | 7/8 | 2 | 1-7/16 | 5/16 | Slot |
| GTT-250-250-W/C | 2 | 250kcmil-1/0 | 250kcmil-6 | 1 | 7/8 | 2-1/8 | 1-7/16 | 5/16 | 5/16 |
| GT2-250-W/C | 3 | 250kcmil-2 | 250kcmil-2 | 2 | 1-3/4 | 3-1/4 | 2-1/2 | 5/16 | 5/16 |
| GT4T-250-2-2-W/C | 4 | 250kcmil-1/0 | 2-12 AL, 2-14 CU | 4 | 2-1/4 | 1 | 1-11/16 | 5/16 | Slot |
| GT4T-350-2-2-W/C | 4 | 350kcmil-4/0 | 2-12 AL, 2-14 CU | 4 | 2-7/16 | 1 | 1-3/4 | 3/8 | Slot |

All wire sizes, unless noted otherwise, are American Wire Gauge (AWG)

Note: Covers are for indoor use only.

Tested to UL 486A/B, UL File E6207

Mechanical

| | | | | |
|--------------------------------------------------------------------------------------------------------------------|----------------------------------------------------------------------------------------------------------------|-----------------------------------------------------------------------------------------------------------|----------------------------------------------------------------------------------------------------------------|---------------------------------------------------------------------------------------------------------------|
| <p>TA-I-TC</p>  <p>143</p> | <p>AU-I-TC</p>  <p>144</p> | <p>TA</p>  <p>145</p> | <p>ATTA</p>  <p>146</p> | <p>AU</p>  <p>147</p> |
| <p>ATAU</p>  <p>148</p> | <p>T3A</p>  <p>149</p> | <p>T4A4</p>  <p>150</p> | <p>PB</p>  <p>151</p> | <p>PBHD</p>  <p>152</p> |
| <p>PBMW</p>  <p>153</p> | <p>TLK</p>  <p>154</p> | <p>USGL</p>  <p>155</p> | <p>SPA</p>  <p>156</p> | <p>CA</p>  <p>157</p> |
| <p>GTA</p>  <p>158</p> | <p>GTT</p>  <p>159</p> | <p>GTC</p>  <p>160</p> | <p>GT2</p>  <p>161</p> | <p>GT4T</p>  <p>162</p> |
| <p>MGTT</p>  <p>163</p> | <p>PTA</p>  <p>164</p> | <p>MAC</p>  <p>165</p> | <p>IPC</p>  <p>166</p> | <p>SGB</p>  <p>167</p> |
| <p>GH, GHS</p>  <p>168</p> | <p>GMS, GWL</p>  <p>169</p> | <p>GT</p>  <p>170</p> | <p>LS, LSN</p>  <p>171</p> | <p>PED-Z</p>  <p>172</p> |
| <p>PED-X, PSA-Z</p>  <p>173</p> | <p>PET</p>  <p>174</p> | <p>PTT</p>  <p>175</p> | <p>NB</p>  <p>176</p> | <p>NBAS</p>  <p>177</p> |

Mechanical

| | | | | |
|--------------------------------------------------------------------------------------------------------------|-----------------------------------------------------------------------------------------------------------------|----------------------------------------------------------------------------------------------------------------|---------------------------------------------------------------------------------------------------------------|---------------------------------------------------------------------------------------------------------------|
| <p>NBAE</p>  <p>178</p> | <p>NBCE</p>  <p>179</p> | <p>NBST</p>  <p>180</p> | <p>SCNL</p>  <p>181</p> | <p>SCNM</p>  <p>182</p> |
| <p>USPASS</p>  <p>183</p> | <p>SS,SSK,SSKC</p>  <p>184</p> | <p>PG</p>  <p>185</p> | <p>GRM, GRF</p>  <p>186</p> | <p>SLU/SAU</p>  <p>187</p> |
| <p>SLS/SAS</p>  <p>187</p> | <p>E, H</p>  <p>188</p> | <p>SLUH</p>  <p>189</p> | <p>LO</p>  <p>190</p> | <p>VT/LO-S</p>  <p>191</p> |
| <p>XT, LY</p>  <p>192</p> | <p>CP</p>  <p>193</p> | <p>CO</p>  <p>194 - 195</p> | <p>SX</p>  <p>196</p> | <p>2SC</p>  <p>197</p> |
| <p>MU, LU</p>  <p>198</p> | <p>CL</p>  <p>199 - 200</p> | <p>HL</p>  <p>201</p> | <p>CL</p>  <p>202</p> | <p>H2L</p>  <p>203</p> |
| <p>H3L</p>  <p>204</p> | <p>D167</p>  <p>205</p> | <p>CAN</p>  <p>206</p> | <p>SK</p>  <p>207</p> | <p>TORQUE INDEX</p> <p>208</p> |

Dual Rated Solderless Lugs - TC



TYPE TA-I-TC

Features

- Manufactured from high strength 6061-T6 aluminum alloy
- Electro-tin plated
- Chamfered wire entry
- Suitable for use in circuits rated 35KV or less, proper high voltage spacing and insulation techniques must be used
- Rated to 90° C/194° F

Benefits

- Suitable for use with either copper or aluminum conductors
- Provides low contact resistance
- Provides ease of installation
- Application versatility

C

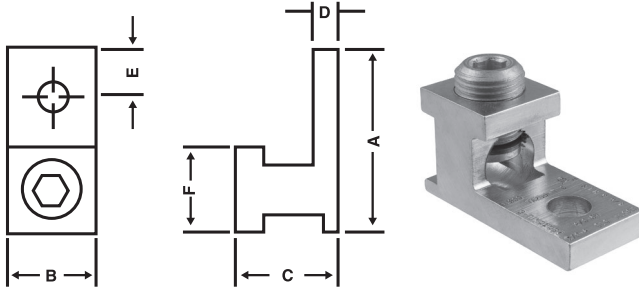

SCREW BODY
allows tightening and loosening with internal hex head

DISK PAD
eliminates tearing of strands in DLO and flex wire

BELLEVILLE WASHER
provides constant normal force around disk pad

| Catalog Number | Conductor Range | Fine Strand and CU Conductor Range | Mounting Hole Diameter | Dimensions (in.) | | | | | | Hex Size |
|----------------|-------------------|--------------------------------------------------------------|------------------------|------------------|-------|-------|------|------|-------|----------|
| | | | | A | B | C | D | E | F | |
| TA3/0I-TC | 3/0-6 | 2/0-6 CLASS H, I, K, & DLO 1-6 CLASS M | .344 | 1.875 | .875 | 1.000 | .250 | .470 | .875 | 1/4 |
| TA250I-TC | 250kcmil-6 | 4/0-6 CLASS H, I, K 2/0-6 CLASS M 3/0-6 DLO | .406 | 2.125 | .938 | 1.125 | .293 | .500 | 1.00 | 5/16 |
| TA350I-TC | 350kcmil-6 | 250kcmil-6 CLASS H, I, K 4/0-6 CLASS M 262.2-6 DLO | .406 | 2.375 | 1.000 | 1.375 | .312 | .625 | 1.125 | 5/16 |
| TA500I-TC | 500kcmil-4 | 350kcmil-4 CLASS H, I, K 4/0-6 CLASS M 373.7-4 DLO | .406 | 2.613 | 1.350 | 1.500 | .423 | .690 | 1.200 | 3/8 |
| TA800I-TC | 800kcmil-300kcmil | 500kcmil-4 CLASS H, I, K 4/0-3/0 CLASS M 535.3-3/0 DLO | .660 | 3.250 | 1.468 | 1.875 | .500 | .880 | 1.500 | 1/2 |

All wire sizes, unless noted otherwise, are American Wire Gauge (AWG)
De-Ox Inhibitor is recommended for all aluminum terminations.

Dual Rated Solderless Lugs - TC



TYPE AU-I-TC

Features

- Manufactured from high strength 6061-T6 aluminum alloy
- Electro-tin plated
- CSA Certified and UL listed
- I-Beam construction
- Utilizes nVent ILSCO's patented TC screw
- Rated for 600 volts, 90° C/194° F

Benefits

- Dual rated for copper or aluminum conductors
- Provides low contact resistance
- Ensures reliability for copper or aluminum conductors
- Reduces material content while maintaining the same performance standards as full sized connectors
- Patented TC screw eliminates the need for ferrules
- Suitable for fine strand (flex) or class B/C building code conductor
- Reusable

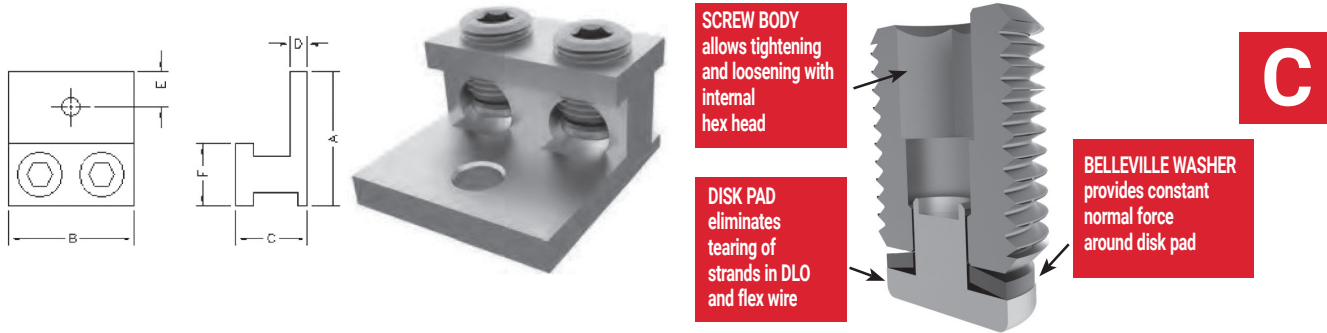

| Catalog Number | Class B/C CU or AL Conductor Size Range (AWG/kcmil) | Fine Strand and CU Conductor Size Range | Mounting Hole Diameter | Dimensions (in.) | | | | | | Internal Hex Size |
|----------------|-----------------------------------------------------|-----------------------------------------------------------|------------------------|------------------|-------|-------|------|------|-------|-------------------|
| | | | | A | B | C | D | E | F | |
| AU3/0I-TC | 3/0-6 | 2/0-6 CLASS H, I, K, & DLO 1-6 CLASS M | .344 | 1.875 | 1.828 | 1.000 | .250 | .470 | .875 | 1/4 |
| AU250I-TC | 250-6 | 4/0-6 CLASS H, I, K 2/0-6 CLASS M 3/0-6 DLO | .406 | 2.125 | 1.954 | 1.125 | .293 | .500 | 1.00 | 5/16 |
| AU350I-TC | 350-6 | 250-6 CLASS H, I, K 4/0-6 CLASS M 262.2-6 DLO | .406 | 2.375 | 2.078 | 1.375 | .312 | .625 | 1.125 | 5/16 |
| AU500I-TC | 500-4 | 350-4 CLASS H, I, K 4/0-4 CLASS M 373.7-4 DLO | .406 | 2.613 | 2.825 | 1.500 | .423 | .690 | 1.200 | 3/8 |
| AU800I-TC | 800-300 | 500-3/0 CLASS H, I, K 4/0-3/0 CLASS M 535.3-3/0 DLO | .660 | 3.061 | 1.468 | 1.875 | .500 | .880 | 1.500 | 1/2 |

De-Ox inhibitor is recommended for all aluminum terminations.

Aluminum Mechanical Lugs

Dual Rated - One Conductor



TYPE TA

Features

- Manufactured from high strength 6061-T6 aluminum alloy
- Electro-tin plated
- Chamfered wire entry
- Suitable for use in circuits rated 35KV or less, proper high voltage spacing and insulation techniques must be used
- Rated to 90° C/194° F

Benefits

- Suitable for use with either copper or aluminum conductors
- Provides low contact resistance
- Provides ease of installation
- Application versatility

C

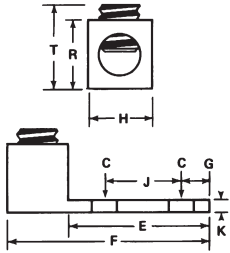

Fig. 1



Fig. 2



Fig. 3



Fig. 4

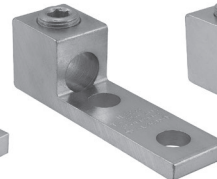

Fig. 5

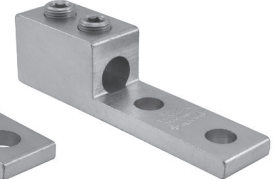

Fig. 6

| Catalog Number | Figure Number | Conductor Range | Bolt Size | Dimensions (in.) | | | | | | | | | Hex Size |
|----------------|---------------|----------------------------------------|-----------|------------------|---------|---------|-------|--------|-------|------|---------|---------|----------|
| | | | | C | E | F | G | H | J | K | R | T | |
| TA-6-S‡ | 1 | 4-14 | 1/4 | 17/64 | 11/16 | 1-1/16 | 1/4 | 1/2 | - | 3/32 | 1/2 | 41/64 | S |
| TA-2‡ | 1 | One: 2-14, Two: 10-14CU 10-12 AL | 1/4 | 17/64 | 11/16 | 1-5/32 | 5/16 | 1/2 | - | 7/64 | 9/16 | 3/4 | S |
| TA-0‡ | 1 | One: 1/0-14 Two: 4-12 | 1/4 | 17/64 | 27/32 | 1-15/32 | 7/16 | 5/8 | - | 3/16 | 25/32 | 29/32 | S |
| TA-2/0‡ | 2 | 2/0-14 | 1/4 | 17/64 | 27/32 | 1-15/32 | 7/16 | 5/8 | - | 3/16 | 25/32 | 1-1/32 | 3/16 |
| TA-250‡ | 2 | 250kcmil-6 | 5/16 | 21/64 | 1 | 2 | 15/32 | 1 | - | 1/4 | 1-1/8 | 1-21/64 | 5/16 |
| TA-300‡ | 2 | 300kcmil-6 | 1/4 | 9/32 | 1 | 2 | 1/2 | 55/64 | - | 1/4 | 1-1/8 | 1-11/32 | 5/16 |
| TA-350‡ | 2 | 350kcmil-6 | 3/8 | 13/32 | 1-1/8 | 2-1/4 | 1/2 | 1-1/8 | - | 1/4 | 1-1/4 | 1-29/64 | 3/8 |
| TA-500‡ | 2 | 500kcmil-4 | 3/8 | 13/32 | 1-19/32 | 2-13/16 | 7/8 | 1-1/2 | - | 5/16 | 1-13/16 | 1-13/16 | 3/8 |
| TA-500-S | 3 | One: 600kcmil-4 Two: 250kcmil-1/0* | 3/8 | 13/32 | 1-1/2 | 2-13/16 | 5/8 | 1-5/16 | - | 5/16 | 1-13/16 | 2-3/16 | 1/2 |
| TA-600 | 2 | 600kcmil-2 | 3/8 | 13/32 | 1-13/16 | 3-3/16 | 7/8 | 1-1/2 | - | 7/16 | 1-9/16 | 1-31/32 | 1/2 |
| TA-800 | 2 | 800kcmil-300kcmil | 5/8 | 21/32 | 1-3/4 | 3-3/8 | 7/8 | 1-3/4 | - | 1/2 | 1-15/16 | 2-15/64 | 1/2 |
| TA-800-S | 4 | 800kcmil-3/0 | 5/8 | 21/32 | 1-3/4 | 3-1/4 | 11/16 | 1-5/16 | - | 1/2 | 1-13/16 | 2-3/16 | 1/2 |
| TA-1000 | 2 | 1000kcmil-350kcmil | 5/8 | 21/32 | 1-3/4 | 3-3/8 | 7/8 | 1-3/4 | - | 1/2 | 1-15/16 | 2-25/64 | 9/16 |
| TA-1000-S | 4 | 1000kcmil-500kcmil | 5/8 | 21/32 | 1-3/4 | 3-1/4 | 11/16 | 1-7/16 | - | 1/2 | 1-13/16 | 2-3/16 | 9/16 |
| TA-350-2NS | 5 | 350kcmil-6 | 1/2 | 9/16 | 3 | 4-5/16 | 5/8 | 1-1/8 | 1-3/4 | 5/16 | 1-3/8 | 1-29/64 | 3/8 |
| TA-600-2NS | 5 | 600kcmil-2 | 1/2 | 9/16 | 3-5/16 | 4-11/16 | 5/8 | 1-1/2 | 1-3/4 | 7/16 | 1-3/8 | 1-59/64 | 1/2 |
| TA-800-2NS | 5 | 800kcmil-300kcmil | 1/2 | 9/16 | 3-1/8 | 4-3/4 | 5/8 | 1-3/4 | 1-3/4 | 1/2 | 1-15/16 | 2-3/16 | 1/2 |
| TA-1000-2NS | 5 | 1000kcmil-500kcmil | 1/2 | 9/16 | 3-1/8 | 4-3/4 | 5/8 | 1-3/4 | 1-3/4 | 1/2 | 1-15/16 | 2-27/64 | 9/16 |
| TA-350-2N | 6 | 350kcmil-6 | 1/2 | 9/16 | 3-1/4 | 5-1/2 | 5/8 | 1-1/4 | 1-3/4 | 3/8 | 1-1/2 | 1-21/32 | (2)3/8 |
| TA-600-2N | 6 | 600kcmil-2 | 1/2 | 9/16 | 3-1/4 | 5-1/2 | 5/8 | 1-3/8 | 1-3/4 | 3/8 | 1-1/2 | 1-31/32 | (2)3/8 |
| TA-800-2N | 6 | 800kcmil-300kcmil | 1/2 | 9/16 | 3-5/8 | 5.97 | 5/8 | 1-1/2 | 1-3/4 | 1/2 | 1.813 | 2-15/64 | (2)1/2 |
| TA-1000-2N | 6 | 1000kcmil-350kcmil | 1/2 | 9/16 | 3-5/8 | 5.97 | 5/8 | 1-5/8 | 1-3/4 | 1/2 | 1.813 | 2-25/64 | (2)1/2 |

All wire sizes, unless noted otherwise, are American Wire Gauge (AWG)

De-Ox Inhibitor is recommended for all aluminum terminations.

* Parallel conductor must be identical

‡ Tested to UL 486A/B, UL File E6207

‡ Tested to UL 467, UL File E6207

Aluminum Mechanical Lugs

Anti-Turn Connector

Dual Rated - One Conductor

RoHS
Compliant

UL
LISTED
453G

SA
LR-29601

TYPE ATTA

Features

- Manufactured from high strength aluminum alloy
- Electro-tin plated
- Chamfered wire entry
- Anti-rotation bar
- Suitable for use in circuits rated 35KV or less; proper high voltage spacing and insulation techniques must be used
- AL9CU, rated to 90° C/194° F

Benefits

- Suitable for use with copper or aluminum conductors
- Provides low contact resistance
- For easy conductor insertion
- Reduces risk of movement at installation
- Application versatility

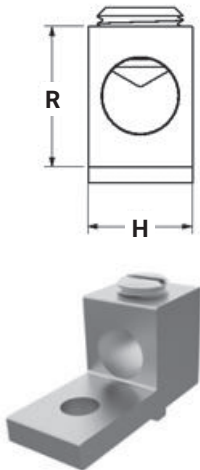

Fig. 1

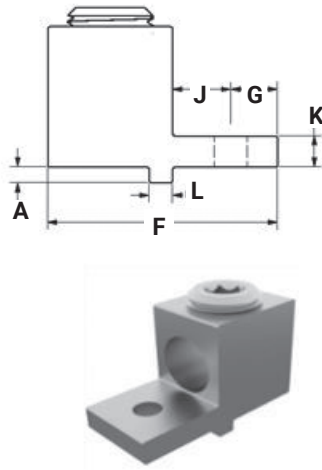

Fig. 3

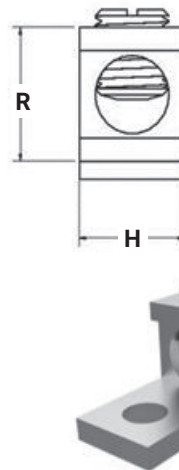

Fig. 2

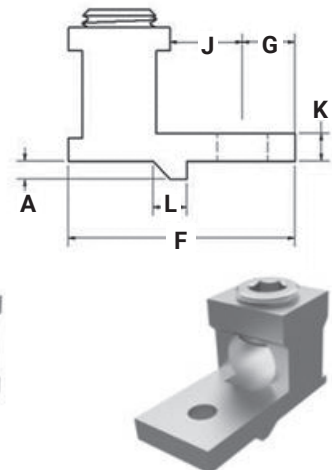

Fig. 4

C

| Catalog Number | Figure Number | Conductor Range | Bolt Size | Dimensions - in. (mm) | | | | | | | | Hex Size |
|----------------|---------------|-----------------|-----------|-----------------------|-----------------|-----------------|-----------------|-----------------|----------------|----------------|----------------|----------|
| | | | | H | R | F | J | G | K | L | A | |
| ATTA-1/0-14 | 1 | 1/0-14 | 1/4 | 0.625 (15.9) | 0.787 (20.0) | 1.468 (37.3) | 0.468 (11.9) | 0.375 (9.5) | 0.187 (4.7) | 0.125 (3.2) | 0.062 (1.6) | SLOT |
| ATTA-2/0-14 | 2 | 2/0-6 | 1/4 | 0.625 (15.9) | 0.747 (19.0) | 1.340 (34.0) | 0.330 (8.4) | 0.310 (7.9) | 0.156 (4.0) | 0.200 (5.1) | 0.100 (2.5) | SLOT |
| ATTA-250-14 | 3 | 250kcmil-6 | 1/4 | 0.836 (21.2) | 1.125 (28.6) | 1.843 (46.8) | 0.468 (11.9) | 0.375 (9.5) | 0.250 (6.4) | 0.188 (4.8) | 0.125 (3.2) | 5/16 |
| ATTA-300-14 | 4 | 300kcmil-6 | 1/4 | 1.000 (25.4) | 1.125 (28.6) | 2.080 (52.8) | 0.330 (8.4) | 0.470 (11.9) | 0.250 (6.4) | 0.273 (6.9) | 0.100 (2.5) | 3/8 |
| ATTA-350-38 | 3 | 350kcmil-6 | 3/8 | 1.000 (25.4) | 1.125 (28.6) | 1.906 (48.4) | 0.500 (12.7) | 0.406 (10.3) | 0.250 (6.4) | 0.187 (4.7) | 0.125 (3.2) | 3/8 |
| ATTA-350-14 | 4 | 350kcmil-6 | 1/4 | 1.000 (25.4) | 1.125 (28.6) | 1.760 (44.7) | 0.390 (9.9) | 0.330 (8.4) | 0.200 (5.1) | 0.273 (6.9) | 0.100 (2.5) | 3/8 |

All wire sizes, unless noted otherwise, are American Wire Gauge (AWG)

De-Ox oxide inhibitor recommended for all aluminum terminations

Tested to UL486A/B, UL File E6207

Aluminum Mechanical Lugs

Dual Rated - Two Conductor



TYPE AU

Features

- Manufactured from high strength 6061-T6 aluminum alloy
- Electro-tin plated
- Chamfered wire entry
- Suitable for use in circuits rated 35KV or less, proper high voltage spacing and insulation techniques must be used
- Rated to 90° C/194° F

Benefits

- Suitable for use with either copper or aluminum conductors
- Provides low contact resistance
- Provides ease of installation
- Application versatility

C

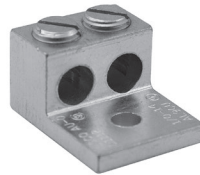
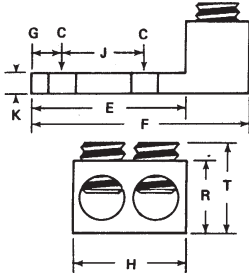

Fig. 1



Fig. 2



Fig. 3



Fig. 4

| Catalog Number | Figure Number | Wire Range | Bolt Size | Dimensions (in.) | | | | | | | | | Hex Size |
|----------------|---------------|-------------------------|-----------|------------------|---------|---------|-------|---------|-------|------|---------|---------|----------|
| | | | | C | E | F | G | H | J | K | R | T | |
| AU-0‡ | 1 | Two: 1/0-14 | 1/4 | 17/64 | 27/32 | 1-15/32 | 7/16 | 1-1/8 | - | 3/16 | 51/64 | 29/32 | S |
| AU-2/0‡ | 2 | Two: 2/0-14 | 1/4 | 17/64 | 27/32 | 1-15/32 | 27/64 | 1-1/4 | - | 3/16 | 51/64 | 1-1/32 | 3/16 |
| AU-250‡ | 2 | Two: 250kcmil-6 | 3/8 | 25/64 | 1-9/16 | 2-9/16 | 7/8 | 1-21/32 | - | 1/4 | 1-3/16 | 1-9/32 | 5/16 |
| AU-350‡ | 2 | Two: 350kcmil-6 | 1/2 | 9/16 | 1-3/4 | 2-7/8 | 7/8 | 1-57/64 | - | 1/4 | 1-1/4 | 1-3/8 | 5/16 |
| AU-600 | 2 | Two: 600kcmil-2 | 1/2 | 17/32 | 1-13/16 | 3-3/16 | 5/8 | 2-13/32 | - | 7/16 | 1-9/16 | 1-31/32 | 1/2 |
| AU-800 | 2 | Two: 800kcmil-300kcmil | 5/8 | 21/32 | 1-3/4 | 3-3/8 | 7/8 | 3-3/16 | - | 1/2 | 1-15/16 | 2-15/64 | 1/2 |
| AU-1000 | 2 | Two: 1000kcmil-500kcmil | 5/8 | 21/32 | 1-3/4 | 3-3/8 | 7/8 | 3-3/16 | - | 1/2 | 1-15/16 | 2-25/64 | 9/16 |
| AU-600-2NS | 3 | Two: 600kcmil-2 | 1/2 | 9/16 | 3-5/16 | 4-11/16 | 5/8 | 2-13/32 | 1-3/4 | 7/16 | 1-3/8 | 2-3/64 | 1/2 |
| AU-800-2NS | 3 | Two: 800kcmil-300kcmil | 1/2 | 9/16 | 3-1/8 | 4-3/4 | 5/8 | 3-3/16 | 1-3/4 | 1/2 | 1-15/16 | 2-3/16 | 1/2 |
| AU-1000-2NS | 3 | Two: 1000kcmil-500kcmil | 1/2 | 9/16 | 3-1/8 | 4-3/4 | 5/8 | 3-3/16 | 1-3/4 | 1/2 | 1-5/8 | 2-33/64 | 9/16 |
| AU-350-2N‡ | 3 | Two: 350kcmil-6 | 1/2 | 9/16 | 3 | 4-5/16 | 5/8 | 2 | 1-3/4 | 5/16 | 1-3/8 | 1-29/64 | 5/16 |
| AU-350-N* | 4 | Two: 350kcmil-6 | 1/2 | 9/16 | 3-1/4 | 5-1/2 | 5/8 | 2-3/4 | 1-3/4 | 3/8 | 1-1/2 | 1-31/32 | 5/16 |
| AU-600-2N* | 4 | Two: 600kcmil-2 | 1/2 | 9/16 | 3-1/4 | 5-1/2 | 5/8 | 2-3/4 | 1-3/4 | 3/8 | 1-1/2 | 1-31/32 | 1/2 |
| AU-800-2N* | 4 | Two: 800kcmil-300kcmil | 1/2 | 9/16 | 3-5/8 | 5-31/32 | 5/8 | 3 | 1-3/4 | 1/2 | 1-13/16 | 2-15/64 | 1/2 |
| AU-1000-2N* | 4 | Two: 1000kcmil-500kcmil | 1/2 | 9/16 | 3-5/8 | 5-31/32 | 5/8 | 3-1/4 | 1-3/4 | 1/2 | 1-13/16 | 2-25/64 | 9/16 |

All wire sizes, unless noted otherwise, are American Wire Gauge (AWG)

De-Ox Inhibitor is recommended for all aluminum terminations.

Tested to UL 486A/B, UL File E6207

‡ Tested to UL 467, UL File E6207

* Mounting hole spacing from side to side, hole to hole is .875

Aluminum Mechanical Lugs

Anti-Turn Connector

Dual Rated - Two Conductor



TYPE ATAU

Features

- Manufactured from high strength aluminum alloy
- Electro-tin plated
- Chamfered wire entry
- Anti-rotation bar
- Suitable for use in circuits rated 35KV or less; proper high voltage spacing and insulation techniques must be used
- AL9CU, rated to 90° C/194° F

Benefits

- Suitable for use with copper or aluminum conductors
- Provides low contact resistance
- For easy conductor insertion
- Reduces risk of movement at installation
- Application versatility

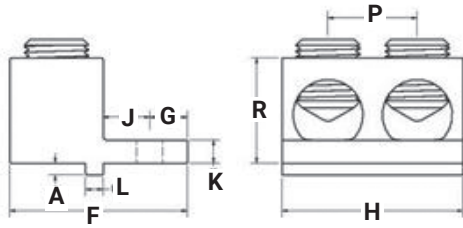

Fig. 1

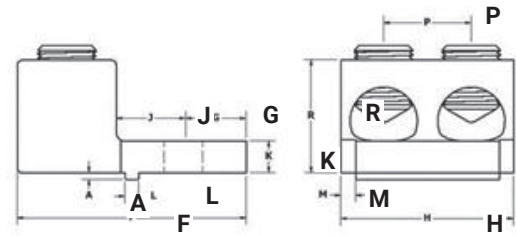

Fig. 2

C

| Catalog Number | Figure Number | Wire Range | Bolt Size | Dimensions - in. (mm) | | | | | | | | | | Hex Size |
|----------------|---------------|------------|-----------|-----------------------|-----------------|-----------------|----------------|-----------------|-----------------|-----------------|-----------------|----------------|----------------|----------|
| | | | | H | R | P | M* | F | J | G | K | L | A | |
| ATAU-2/0-14 | 1 | 2/0-14 | 1/4 | 1.250 (31.8) | 0.787 (20.0) | 0.656 (16.7) | N/A | 1.468 (37.3) | 0.503 (12.8) | 0.340 (8.6) | 0.187 (4.7) | 0.125 (3.2) | 0.062 (1.6) | 3/16 |
| ATAU-350-14 | 1 | 350kcmil-6 | 1/4 | 1.938 (49.2) | 1.125 (28.6) | 0.957 (24.3) | N/A | 1.906 (48.4) | 0.500 (12.7) | 0.406 (10.3) | 0.250 (6.4) | 0.187 (4.7) | 0.125 (3.2) | 5/16 |
| ATAU-350-12* | 2 | 350kcmil-4 | 1/2 | 1.900 (48.3) | 1.250 (31.8) | 0.957 (24.3) | 0.075 (1.9) | 2.875 (73.0) | 0.875 (22.2) | 0.875 (22.2) | 0.250 (6.4) | 0.250 (6.4) | 0.250 (6.4) | 5/16 |
| ATAU-600-12* | 2 | 600kcmil-2 | 1/2 | 2.406 (61.1) | 1.562 (39.7) | 1.219 (31.0) | 0.203 (5.2) | 3.000 (76.2) | 0.938 (23.8) | 0.687 (17.4) | 0.437 (11.1) | 0.187 (4.7) | 0.093 (2.4) | 1/2 |

All wire sizes, unless noted otherwise, are American Wire Gauge (AWG)

De-Ox oxide inhibitor recommended for all aluminum terminations

Tested to UL486A/B, UL File E6207

*Reduced tang design to accommodate physical breaker box mounting limitations

Aluminum Mechanical Lugs

Dual Rated - Three Conductor



TYPE T3A

Features

- Manufactured from high strength 6061-T6 aluminum alloy
- Electro tin plated
- Chamfered wire entry
- Suitable for use in circuits rated 35KV or less, proper high voltage spacing and insulation techniques must be used
- Must be mounted with a minimum of 2 bolts
- Rated to 90° C/194° F

Benefits

- Suitable for use with either copper or aluminum conductors
- Provides low contact resistance
- Provides ease of installation
- Application versatility

C

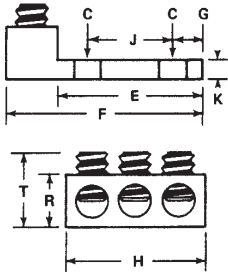

Fig. 1



Fig. 2



Fig. 3

| Catalog Number | Figure Number | Wire Range | Bolt Size | Dimensions (in.) | | | | | | | | | Hex Size |
|----------------|---------------|---------------------------|-----------|------------------|---------|---------|-------|---------|-------|------|---------|---------|----------|
| | | | | C | E | F | G | H | J | K | R | T | |
| T3A2-2 | 1 | Three: 2-14 | 5/16 | 11/32 | 1-11/16 | 2-3/16 | 11/32 | 1-19/32 | 7/8 | 3/16 | 5/8 | 13/16 | Slot |
| T3A2-0 | 1 | Three: 1/0-14 | 3/8 | 7/16 | 2-5/32 | 2-29/32 | 11/32 | 1-15/16 | 1 | 1/4 | 7/8 | 15/16 | Slot |
| T3A2-3/0N | 1 | Three: 3/0-6 | 1/2 | 9/16 | 3 | 3-7/8 | 5/8 | 2-13/16 | 1-3/4 | 5/16 | 1-1/8 | 1-1/2 | 5/16 |
| T3A2-250N | 1 | Three: 250kcmil-6 | 1/2 | 9/16 | 3 | 4 | 5/8 | 2-13/16 | 1-3/4 | 5/16 | 1-3/16 | 1-17/32 | 5/16 |
| T3A2-350N | 1 | Three: 350kcmil-6 | 1/2 | 9/16 | 3 | 4-5/16 | 5/8 | 3 | 1-3/4 | 5/16 | 1-3/8 | 1-17/32 | 5/16 |
| T3A2-600N* | 3 | Three: 600kcmil-2 | 1/2 | 9/16 | 3-1/4 | 5-1/2 | 5/8 | 3-1/2 | 1-3/4 | 3/8 | 1-1/2 | 1-49/64 | 1/2 |
| T3A2-800N* | 3 | Three: 800kcmil-300kcmil | 1/2 | 9/16 | 3-5/8 | 5-31/32 | 5/8 | 4-1/8 | 1-3/4 | 1/2 | 1-13/16 | 2-21/64 | 5/16 |
| T3A2-1000N* | 3 | Three: 1000kcmil-350kcmil | 1/2 | 9/16 | 3-5/8 | 5-31/32 | 5/8 | 4-7/8 | 1-3/4 | 1/2 | 1-13/16 | 2-21/64 | 3/8 |
| T3A4-2 | 2 | Three: 2-14 | 5/16 | 11/32 | 1-11/16 | 2-3/16 | 11/32 | 1-19/32 | 7/8 | 3/16 | 5/8 | 13/16 | Slot |
| T3A4-0 | 2 | Three: 1/0-14 | 3/8 | 7/16 | 2-5/32 | 2-29/32 | 11/32 | 1-15/16 | 1 | 1/4 | 7/8 | 15/16 | Slot |
| T3A4-3/0N | 2 | Three: 3/0-6 | 1/2 | 9/16 | 3 | 3-7/8 | 5/8 | 2-13/16 | 1-3/4 | 5/16 | 1-1/8 | 1-1/2 | 5/16 |
| T3A4-250N | 2 | Three: 250kcmil-6 | 1/2 | 9/16 | 3 | 4 | 5/8 | 2-13/16 | 1-3/4 | 5/16 | 1-3/16 | 1-17/32 | 5/16 |
| T3A4-350N | 2 | Three: 350kcmil-6 | 1/2 | 9/16 | 3 | 4-5/16 | 5/8 | 3 | 1-3/4 | 5/16 | 1-3/8 | 1-17/32 | 5/16 |
| T3A4-600N* | 3 | Three: 600kcmil-2 | 1/2 | 9/16 | 3-1/4 | 5-1/2 | 5/8 | 3-1/2 | 1-3/4 | 3/8 | 1-1/2 | 1-49/64 | 1/2 |
| T3A4-800N* | 3 | Three: 800kcmil-300kcmil | 1/2 | 9/16 | 3-5/8 | 5-31/32 | 5/8 | 4-1/8 | 1-3/4 | 1/2 | 1-13/16 | 2-21/64 | 1/2 |
| T3A4-1000N* | 3 | Three: 1000kcmil-350kcmil | 1/2 | 9/16 | 3-5/8 | 5-31/32 | 5/8 | 4-7/8 | 1-3/4 | 1/2 | 1-13/16 | 2-21/64 | 1/2 |

All wire sizes, unless noted otherwise, are American Wire Gauge (AWG)

De-Ox Inhibitor is recommended for all aluminum terminations.

Tested to UL 486A/B, UL File E6207

* Mounting hole spacing from side to side, hole to hole is .875

Aluminum Mechanical Lugs Dual Rated - Four Conductor

RoHS
Compliant

UL
LISTED
453G

SA
LR-29601

TYPE T4A4

Features

- Manufactured from high strength 6061-T6 aluminum alloy
- Electro-tin plated
- Chamfered wire entry
- Suitable for use in circuits rated 35KV or less, proper high voltage spacing and insulation techniques must be used
- Must be mounted with a minimum of 4 bolts
- Rated to 90° C/194° F

Benefits

- Suitable for use with either copper or aluminum conductors
- Provides low contact resistance
- Provides ease of installation
- Application versatility

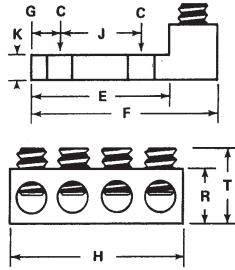

Fig. 1



Fig. 2



Fig. 3



Fig. 4

C

| Catalog Number | Figure Number | Wire Range | Bolt Size | Dimensions (in.) | | | | | | | | | Hex Size |
|----------------|---------------|--------------------|-----------|------------------|-------|---------|-----|---------|-------|------|---------|---------|----------|
| | | | | C | E | F | G | H | J | K | R | T | |
| T4A4-250N* | 1 | 250kcmil-6 | 1/2 | 9/16 | 3 | 4 | 5/8 | 3-49/64 | 1-3/4 | 5/16 | 1-3/16 | 1-17/32 | 5/16 |
| T4A4-350N* | 1 | 350kcmil-6 | 1/2 | 9/16 | 3 | 4-5/16 | 5/8 | 4-1/64 | 1-3/4 | 5/16 | 1-3/8 | 1-17/32 | 5/16 |
| T4A4-600N* | 3 | 600kcmil-2 | 1/2 | 9/16 | 3-1/4 | 5-1/2 | 5/8 | 5 | 1-3/4 | 3/8 | 1-1/2 | 1-7/8 | 1/2 |
| T4A4-800N* | 2 | 800kcmil-300kcmil | 1/2 | 9/16 | 3-5/8 | 5-31/32 | 5/8 | 6 | 1-3/4 | 1/2 | 1-13/16 | 2-13/64 | 1/2 |
| T4A4-1000N* | 4 | 1000kcmil-350kcmil | 1/2 | 9/16 | 3-5/8 | 5-31/32 | 5/8 | 6-1/2 | 1-3/4 | 1/2 | 1-13/16 | 2-13/64 | 1/2 |

All wire sizes, unless noted otherwise, are American Wire Gauge (AWG)

De-Ox Inhibitor is recommended for all aluminum terminations.

Tested to UL 486A/B, UL File E6207

* Mounting hole spacing from side to side, hole to hole is .875

Aluminum Panelboard Lugs

Dual Rated

RoHS
Compliant

UL
LISTED
453G

SA
LR-29601

TYPE PB

Features

- Manufactured from high strength 6061-T6 aluminum alloy
- Electro-tin plated
- Chamfered wire entry
- Suitable for use in circuits rated 35KV or less, proper high voltage spacing and insulation techniques must be used
- Stacked design
- Rated to 90° C/194° F

Benefits

- Suitable for use with either copper or aluminum conductors
- Provides low contact resistance
- Provides ease of installation
- Application versatility
- Saves space and reduces installation time

C

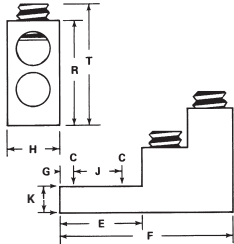

Fig. 1



Fig. 2



Fig. 3



Fig. 4



Fig. 5



Fig. 6

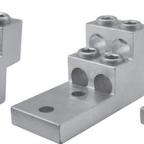

Fig. 7



Fig. 8

| Catalog Number | Figure Number | Wire Range | Bolt Size | Dimensions (in.) | | | | | | | | | Hex Size |
|----------------|---------------|--------------|-----------|------------------|---------|---------|-------|---------|-------|------|-------|---------|----------|
| | | | | C | E | F | G | H | J | K | R | T | |
| PB2-300 | 1 | 300kcmil-6 | 5/16 | 21/64 | 1 | 3 | 15/32 | 1 | - | 5/16 | 2 | 2-5/16 | 5/16 |
| PB2-500 | 2 | 500kcmil-4/0 | 1/4 | 9/32 | 1-11/16 | 2-29/32 | 1/4 | 1-7/16 | 11/16 | 5/8 | 2-3/8 | 1-27/64 | 3/8 |
| PB2-600 | 4 | 600kcmil-2 | 3/8 | 13/32 | 2-11/32 | 4-29/32 | 3/8 | 1-1/2 | 1-3/8 | 5/8 | 3 | 3-29/64 | 1/2 |
| PB3-600 | 6 | 600kcmil-2 | 3/8 | 13/32 | 2-11/32 | 4-29/32 | 3/8 | 2-15/32 | 1-3/8 | 5/8 | 3 | 3-29/64 | 1/2 |
| PB4-600 | 8 | 600kcmil-2 | 3/8 | 13/32 | 2-11/32 | 4-29/32 | 3/8 | 2-15/32 | 1-3/8 | 5/8 | 3 | 3-29/64 | 1/2 |
| PB2-750 | 4 | 750kcmil-1/0 | 3/8 | 13/32 | 2-11/32 | 4-29/32 | 3/8 | 1-11/16 | 1-3/8 | 5/8 | 3 | 3-29/64 | 1/2 |
| PB4-750 | 8 | 750kcmil-1/0 | 3/8 | 13/32 | 2-11/32 | 4-29/32 | 3/8 | 2-5/8 | 1-3/8 | 5/8 | 3 | 3-29/64 | 1/2 |
| PB3-600-2N | 5 | 600kcmil-2 | 1/2 | 9/16 | 3-1/8 | 5-11/16 | 3/8 | 2-15/32 | 1-3/4 | 3/4 | 3 | 3-29/64 | 1/2 |
| PB2-600-2N | 3 | 600kcmil-2 | 1/2 | 9/16 | 3-1/8 | 5-11/16 | 3/8 | 1-1/2 | 1-3/4 | 3/4 | 3 | 3-29/64 | 1/2 |
| PB2-750-2N | 3 | 750kcmil-1/0 | 1/2 | 9/16 | 3-1/8 | 5-11/16 | 3/8 | 1-11/16 | 1-3/4 | 3/4 | 3 | 3-29/64 | 1/2 |
| PB4-600-2N | 7 | 600kcmil-2 | 1/2 | 9/16 | 3-1/8 | 5-11/16 | 3/8 | 2-15/32 | 1-3/4 | 3/4 | 3 | 3-29/64 | 1/2 |
| PB4-750-2N | 7 | 750kcmil-1/0 | 1/2 | 9/16 | 3-1/8 | 5-11/16 | 3/8 | 3-1/16 | 1-3/4 | 3/4 | 3 | 3-29/64 | 1/2 |

All wire sizes, unless noted otherwise, are American Wire Gauge (AWG)

De-Ox Inhibitor is recommended for all aluminum terminations.

Tested to UL 486A/B, UL File E6207

Aluminum Panelboard Lugs

Dual Rated



TYPE PBHD

Features

- Heavy duty design
- Manufactured from high strength aluminum alloy
- Electro-tin plated
- Suitable for use in circuits rated 35KV or less; proper high voltage spacing and insulation techniques must be used
- Stacked design
- AL9CU, rated to 90° C/194° F

Benefits

- Provides greater resistance to pull out
- Suitable for use with copper or aluminum conductors
- Provides low contact resistance
- Application versatility
- Saves space and reduces installation time

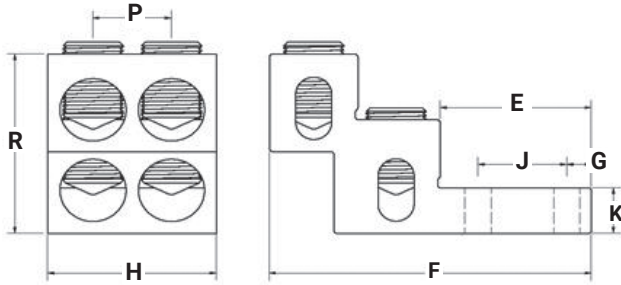

Fig. 1

Fig. 2

Fig. 3

C

| Catalog Number | Figure Number | No. of Ports | Wire Range | Bolt Size | Dimensions - in. (mm) | | | | | | | | Hex Size |
|----------------|---------------|--------------|------------|-----------|-----------------------|-----------------|-----------------|------------------|-----------------|----------------|-----------------|-----------------|----------|
| | | | | | H | R | P | F | J | G | K | E | |
| PBHD2-750 | 1 | 2 | 750kcmil-2 | 3/8 | 1.400 (35.6) | 2.960 (75.2) | N/A | 5.005 (127.1) | 1.380 (35.1) | 0.380 (9.7) | 0.750 (19.1) | 2.350 (59.7) | 1/2 |
| PBHD4-750 | 2 | 4 | 750kcmil-2 | 3/8 | 2.620 (66.5) | 2.960 (75.2) | 1.220 (31.0) | 5.005 (127.1) | 1.380 (35.1) | 0.380 (9.7) | 0.750 (19.1) | 2.350 (59.7) | 1/2 |
| PBHD6-750* | 3 | 6 | 750kcmil-2 | 3/8 | 3.840 (97.5) | 2.960 (75.2) | 1.220 (31.0) | 5.005 (127.1) | 1.380 (35.1) | 0.380 (9.7) | 0.750 (19.1) | 2.350 (59.7) | 1/2 |

All wire sizes, unless noted otherwise, are American Wire Gauge (AWG)

De-Ox inhibitor recommended for all aluminum terminations

Tested to UL486A/B, UL File E6207

* UL Recognized

Aluminum Panelboard Lugs

Dual Rated - Multi Wire

RoHS
Compliant

cUL[®] US
LISTED
453G

TYPE PBMW

Features

- Multi-Wire hole
- Manufactured from high strength aluminum alloy
- Electro-tin plated
- Stacked design
- Suitable for use in circuits rated 35KV or less; proper high voltage spacing and insulation techniques must be used
- AL9CU, rated to 90° C/194° F

Benefits

- Can terminate two wires per port, parallel wires must be identical
- Suitable for use with copper or aluminum conductors
- Provides low contact resistance
- Saves spaces and reduces installation time
- Application versatility

C



Fig. 1

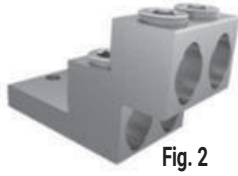

Fig. 2



Fig. 3

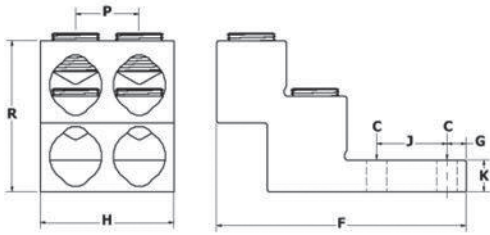

Fig. 4

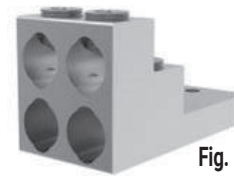
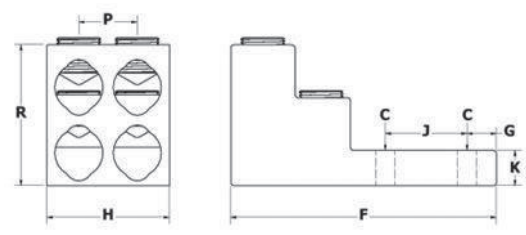

Fig. 5



Fig. 6



| Catalog Number | Figure Number | Wire Range | No. of Ports | Bolt Size | Dimensions | | | | | | | | Hex Size |
|----------------|---------------|---------------------------------------|--------------|-----------|-----------------|-----------------|-----------------|------------------|-----------------|-----------------|-----------------|-----------------|----------|
| | | | | | H | R | P | F | J | G | K | C | |
| PBMW-2-750-38 | 1 | One: 750kcmil-2 *Two: 4/0-1/0 | 2 | 3/8 | 1.310 (33.3) | 2.960 (75.2) | N/A | 4.910 (124.7) | 1.380 (35.1) | 0.380 (9.7) | 0.625 (15.9) | 0.406 (10.3) | 1/2 |
| PBMW-4-750-38 | 2 | One: 750kcmil-2 *Two: 4/0-1/0 | 4 | 3/8 | 2.620 (66.5) | 2.960 (75.2) | 1.250 (31.8) | 4.910 (124.7) | 1.380 (35.1) | 0.380 (9.7) | 0.625 (15.9) | 0.406 (10.3) | 1/2 |
| PBMW-6-750-38 | 3 | One: 750kcmil-2 *Two: 4/0-1/0 | 6 | 3/8 | 3.930 (99.8) | 2.960 (75.2) | 1.265 (32.1) | 4.910 (124.7) | 1.380 (35.1) | 0.380 (9.7) | 0.625 (15.9) | 0.406 (10.3) | 1/2 |
| PBMW-2-750-12 | 4 | One: 750kcmil-2 *Two: 250kcmil-1/0 | 2 | 1/2 | 1.310 (33.3) | 3.000 (76.2) | N/A | 5.687 (144.4) | 1.750 (44.5) | 0.625 (15.9) | 0.750 (19.1) | 0.562 (14.3) | 1/2 |
| PBMW-4-750-12 | 5 | One: 750kcmil-2 *Two: 250kcmil-1/0 | 4 | 1/2 | 2.620 (66.5) | 3.000 (76.2) | 1.250 (31.8) | 5.687 (144.4) | 1.750 (44.5) | 0.625 (15.9) | 0.750 (19.1) | 0.562 (14.3) | 1/2 |
| PBMW-6-750-12 | 6 | One: 750kcmil-2 *Two: 250kcmil-1/0 | 6 | 1/2 | 3.930 (99.8) | 3.000 (76.2) | 1.265 (32.1) | 5.687 (144.4) | 1.750 (44.5) | 0.625 (15.9) | 0.750 (19.1) | 0.562 (14.3) | 1/2 |

All wire sizes, unless noted otherwise, are American Wire Gauge (AWG)

De-Ox oxide inhibitor recommended for all aluminum terminations

Tested to UL486A/B, UL File E6207

* Parallel wires must be identical

Transformer Lug Kits

Dual Rated

RoHS
Compliant

UL
LISTED
453G

SA
LR-29601

TYPE TLK

Features

- Connectors manufactured from high strength 6061-T6 aluminum alloy
- Electro-tin plated
- Chamfered wire entry
- Suitable for use in circuits rated 35KV or less, proper high voltage spacing and insulation techniques must be used
- Kit includes all required hardware
- Rated to 90° C/194° F

Benefits

- Suitable for use with either copper or aluminum conductors
- Provides low contact resistance
- Provides ease of installation
- Application versatility



C

| Catalog Number | XFMR KVA Size | Lugs in Kit | Bolts in Kit |
|----------------|--------------------------------------|---------------------------------------|--------------------------------------------------------------------------------------------------------------------------|
| TLK-1 | 15-37 1/2 1-Phase, 15-45 3-Phase | Eight TA-2, Four TA-250 | Eight 1/4-20 x 3/4 Bolts, Eight 1/4-20 Flange Nuts |
| TLK-2 | 50-75 1-Phase, 75-112 1/2 3-Phase | Twelve TA-250 | Eight 1/4-20 x 3/4 Bolts, Eight 1/4-20 x 1-3/4 Bolts and Sixteen 1/4-20 Flange Nuts |
| TLK-3 | 100-167 1-Phase, 150-300 3-Phase | Three TA-250 and Twenty-two TA-600 | Three 1/4-20 x 3/4 Bolts, Three 1/4-20 nuts, Sixteen 3/8-16-2 Bolts, Sixteen 3/8-16 Flange Nuts, Sixteen 3/8 flat washer |
| TLK-4 | 500 3-Phase | Twenty-nine TA-600 | Eighteen 3/8-16 x 2 Bolts and Eighteen 3/8-16 Flange Nuts |

All wire sizes, unless noted otherwise, are American Wire Gauge (AWG)

Dimensional data for connectors see Type TA.

De-Ox Inhibitor is recommended for all aluminum terminations.

nVent ILSCO Lay-In ClearTrax

Connectors

RoHS
Compliant



TYPE USGL

Features

- Compact, lay-in design
- Manufactured from high strength 6061-T6 aluminum for strength and conductivity
- High strength aluminum 5/16 in drive torque screw
- Clear plated coating
- Designed for installation on standard NEMA mounting holes
- Suitable for use in circuits rated 35KV or less, proper high voltage spacing and insulation techniques must be used
- 1-3/4 in NEMA spacing on mounting holes
- Rated to 90° C/194° F

Benefits

- Solves the problem of trying to bend larger size cables into place
- Dual rated for aluminum or copper conductors
- Enables range taking
- Provides low contact resistance
- Conforms to industry standards
- Application versatility
- Industry standard

C

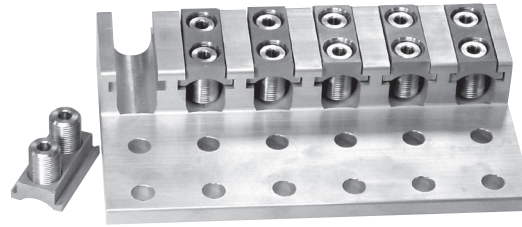
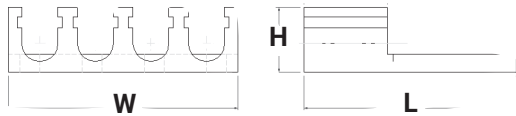

| Catalog Number | No. of Mtg. Holes | No. of Ports | Wire Range | Mounting Bolt Size | Dimensions (in.) | | | Hex Size |
|----------------|-------------------|--------------|----------------|--------------------|------------------|--------|--------|----------|
| | | | | | Width | Length | Height | |
| USGL-350R21 | 2 | 1 | 350 kcmil-6 | 1/2 | 1.50 | 4.69 | 1.56 | 5/16 |
| USGL-350R42 | 4 | 2 | 350 kcmil-6 | 1/2 | 2.75 | 4.69 | 1.56 | 5/16 |
| USGL-350R43 | 4 | 3 | 350 kcmil-6 | 1/2 | 4.00 | 4.69 | 1.56 | 5/16 |
| USGL-350R64 | 6 | 4 | 350 kcmil-6 | 1/2 | 5.25 | 4.69 | 1.56 | 5/16 |
| USGL-350R86 | 8 | 6 | 350 kcmil-6 | 1/2 | 7.75 | 4.69 | 1.56 | 5/16 |
| USGL-350R128 | 12 | 8 | 350 kcmil-6 | 1/2 | 10.25 | 4.69 | 1.56 | 5/16 |
| USGL-600R21 | 2 | 1 | 600 kcmil-2 | 1/2 | 1.68 | 5.35 | 1.69 | 5/16 |
| USGL-600R42 | 4 | 2 | 600 kcmil-2 | 1/2 | 3.08 | 5.35 | 1.69 | 5/16 |
| USGL-600R63 | 6 | 3 | 600 kcmil-2 | 1/2 | 4.81 | 5.35 | 1.69 | 5/16 |
| USGL-600R84 | 8 | 4 | 600 kcmil-2 | 1/2 | 6.45 | 5.35 | 1.69 | 5/16 |
| USGL-600R106 | 10 | 6 | 600 kcmil-2 | 1/2 | 8.69 | 5.35 | 1.69 | 5/16 |
| USGL-600R148 | 14 | 8 | 600 kcmil-2 | 1/2 | 11.70 | 5.35 | 1.69 | 5/16 |
| USGL-750R21 | 2 | 1 | 750 kcmil-1/0 | 1/2 | 1.76 | 5.97 | 1.81 | 5/16 |
| USGL-750R42 | 4 | 2 | 750 kcmil-1/0 | 1/2 | 3.31 | 5.97 | 1.81 | 5/16 |
| USGL-750R63 | 6 | 3 | 750 kcmil-1/0 | 1/2 | 4.88 | 5.97 | 1.81 | 5/16 |
| USGL-750R84 | 8 | 4 | 750 kcmil-1/0 | 1/2 | 6.45 | 5.97 | 1.81 | 5/16 |
| USGL-750R126 | 12 | 6 | 750 kcmil-1/0 | 1/2 | 9.95 | 5.97 | 1.81 | 5/16 |
| USGL-750R148 | 14 | 8 | 750 kcmil-1/0 | 1/2 | 12.30 | 5.97 | 1.81 | 5/16 |
| USGL-1000R21 | 2 | 1 | 1000 kcmil-1/0 | 1/2 | 2.00 | 6.19 | 1.88 | 5/16 |
| USGL-1000R22 | 2 | 2 | 1000 kcmil-1/0 | 1/2 | 3.68 | 6.19 | 1.88 | 5/16 |
| USGL-1000R42 | 4 | 2 | 1000 kcmil-1/0 | 1/2 | 3.68 | 6.19 | 1.88 | 5/16 |
| USGL-1000R63 | 6 | 3 | 1000 kcmil-1/0 | 1/2 | 5.37 | 6.19 | 1.88 | 5/16 |
| USGL-1000R84 | 8 | 4 | 1000 kcmil-1/0 | 1/2 | 7.06 | 6.19 | 1.88 | 5/16 |
| USGL-1000R126 | 12 | 6 | 1000 kcmil-1/0 | 1/2 | 10.44 | 6.19 | 1.88 | 5/16 |
| USGL-1000R168 | 16 | 8 | 1000 kcmil-1/0 | 1/2 | 13.81 | 6.19 | 1.88 | 5/16 |

All wire sizes, unless noted otherwise, are American Wire Gauge (AWG)
Add T for tin plated, P for Pre-filled with De-Ox

Aluminum Splicer/Reducer

Dual Rated

RoHS
Compliant

UL
LISTED
453G

SA
LR-29601

TYPE SPA

Features

- Manufactured from high strength 6061-T6 aluminum alloy
- Electro-tin plated
- Chamfered wire entry
- Rounded bottoms
- Large screw diameters
- Wire stop in center
- Suitable for use in circuits rated 35KV or less, proper high voltage spacing and insulation techniques must be used
- Rated to 90° C/194° F

Benefits

- Suitable for use with either copper or aluminum conductors
- Provides low contact resistance
- Provides ease of installation
- Facilitates taping
- Ensures all wire strands are held securely
- Prevents dissimilar metals coming into contact
- Application versatility

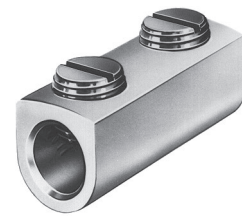
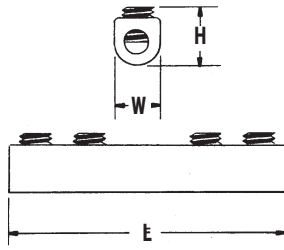

C

| Catalog Number | Wire Range | Dimensions (in.) | | | No. of Screws | Screw Diameter | Hex Size |
|----------------|--------------------|------------------|--------|--------|---------------|----------------|----------|
| | | Width | Length | Height | | | |
| SPA-2 | 2-14 | 1-3/16 | 29/64 | 9/16 | 2 | 3/8 | Slot |
| SPA-0 | 1/0-14 | 1-29/32 | 5/8 | 11/16 | 2 | 7/16 | 3/16 |
| SPA-250 | 250kcmil-6 | 2-5/16 | 7/8 | 1 | 2 | 5/8 | 5/16 |
| SPA-350 | 350kcmil-10 | 2-15/32 | 1 | 1-1/4 | 2 | 11/16 | 5/16 |
| SPA-500 | 500kcmil-4 | 3-7/8 | 1-1/8 | 1-5/8 | 2 | 13/16 | 3/8 |
| SPA-750 | 750kcmil-250kcmil | 5-7/16 | 1-3/8 | 1-3/4 | 4 | 15/16 | 1/2 |
| SPA-1000 | 1000kcmil-500kcmil | 8-11/16 | 1-3/4 | 1-3/4 | 6 | 1-1/8 | 9/16 |

All wire sizes, unless noted otherwise, are American Wire Gauge (AWG)
De-Ox Inhibitor is recommended for all aluminum terminations.
Tested to UL 486A/B, UL File E6207

Aluminum Box-Type Mechanical Lugs

Dual Rated

RoHS
Compliant



TYPE CA

Features

- Manufactured from high strength 6061-T6 aluminum alloy
- Electro-tin plated
- UL Recognized for 75° C/167° F and CSA Certified
- Design includes bossed mounting holes
- Suitable for use in circuits rated 35KV or less, proper high voltage spacing and insulation techniques must be used

Benefits

- Suitable for use with either copper or aluminum conductors
- Provides low contact resistance
- Acts as an anti-rotation device and prevents connector from turning
- Application versatility

C

Fig. 1 & 2 Bottom View

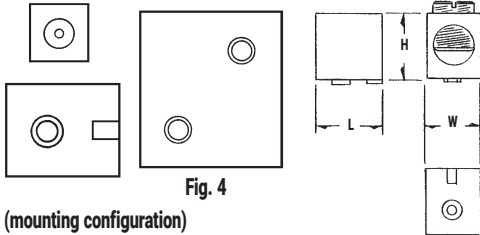

Fig. 3

Bottom view (mounting configuration)

Fig. 4



Fig. 1

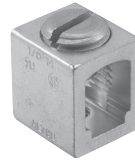

Fig. 2



Fig. 3



Fig. 4

| Catalog Number | Figure Number | Wire Range | Dimensions (in.) | | | Style and Size of Boss | Flat Bottom | Bossed Hole Tapped | Two Mounting Holes Tapped | Hex Size |
|----------------|---------------|------------------------|------------------|---------|---------|------------------------|-------------|--------------------|---------------------------|----------|
| | | | L | W | H | | | | | |
| CA4SP | 1 | 2-14 CU 2-12 AL | 15/32 | 1/2 | 23/32 | Sq. .229 | - | 10-32 | - | Slot |
| CA4RP | 1 | 2-14 CU 2-12 AL | 15/32 | 1/2 | 23/32 | Rd. .229 | - | 10-32 | - | Slot |
| CA5SP | 2 | 1/0-14 CU 1/0-12 AL | 5/8 | 9/16 | 11/16 | Sq. .229 | - | 10-32 | - | Slot |
| CA5RP | 2 | 1/0-14 CU 1/0-12 AL | 5/8 | 9/16 | 11/16 | Rd. .229 | - | 10-32 | - | Slot |
| CA6RP | 3 | 250kcmil-6 | 1 | 13/16 | 1 | Rd. .285 | - | 1/4-20 | - | 5/16 |
| CA7 | 4 | 500kcmil-1/0 | 1-3/8 | 1-15/64 | 1-13/32 | - | YES | - | 1/4-20 | 3/8 |
| CA8 | 4 | 750kcmil-500kcmil | 1-15/16 | 1-3/8 | 1-3/4 | - | YES | - | 5/16-18 | 1/2 |

All wire sizes, unless noted otherwise, are American Wire Gauge (AWG)
De-Ox Oxide Inhibitor is recommended for all aluminum terminations.
Tested to UL 486A/B, UL File E6207

Parallel Tap Connectors

Dual Rated - Lay-In

RoHS
Compliant

UL
LISTED
453G

CSA
LR-29601

TYPE GTA

Features

- Manufactured from high strength 6061-T6 aluminum alloy
- Electro-tin plated
- UL Listed and CSA Certified for 600 volts, 90° C/194° F
- Compact design
- Range taking
- Re-usable
- Lay-in main conductor
- Insulating cover available

Benefits

- Suitable for use with either copper or aluminum conductors
- Provides low contact resistance
- Ensures reliability for copper or aluminum conductors
- Saves space and reduces installation time
- Permits inventories to be kept to a minimum
- Provides efficient use and flexibility in the field
- No need to break the feeder cable
- Eliminates taping

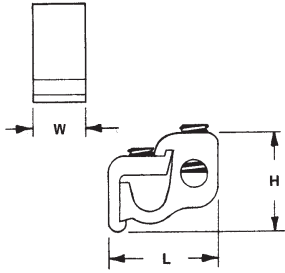

Fig. 1

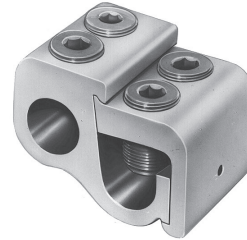
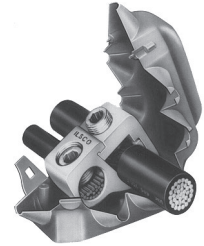

Fig. 2



C

| Catalog Number | Figure Number | Wire Range | | Dimensions (in.) | | | Hex Size | |
|----------------|---------------|--------------------|---------------------|------------------|---------|---------|----------|------|
| | | Main | Tap | L | W | H | Main | Tap |
| GTA-2-2 | 1 | 2-12 str | 2-12 AL 2-14 CU | 1-1/4 | 9/16 | 1 | Slot | Slot |
| GTA-0-0 | 1 | 1/0-2 | 1/0-12 AL 1/0-14 CU | 1-9/16 | 3/4 | 1-1/8 | Slot | Slot |
| GTA-250-0 | 1 | 250kcmil-1/0 | 1/0-12 AL 1/0-14 CU | 2 | 15/16 | 1-7/16 | 5/16 | Slot |
| GTA-250-250 | 1 | 250kcmil-1/0 | 250kcmil-6 | 2-1/8 | 15/16 | 1-7/16 | 5/16 | 5/16 |
| GTA-350-350 | 1 | 350kcmil-4/0 | 350kcmil-6 | 2-7/16 | 1 | 1-11/16 | 3/8 | 3/8 |
| GTA-500-500 | 1 | 500kcmil-350kcmil | 500kcmil-2 | 2-15/16 | 1-1/4 | 2 | 3/8 | 3/8 |
| GTA-750-500 | 1 | 750kcmil-500kcmil | 500kcmil-2 | 3-3/8 | 1-5/16 | 2-7/16 | 3/8 | 3/8 |
| GTA-750-750 | 2 | 750kcmil-500kcmil | 750kcmil-1/0 | 3-3/8 | 2-5/8 | 2-7/16 | 1/2 | 1/2 |
| GTA-1000-500 | 1 | 1000kcmil-750kcmil | 500kcmil-2 | 3-3/8 | 1-15/16 | 2-7/16 | 1/2 | 3/8 |

Note: If ordering with cover, add suffix W/C to catalog number.

All wire sizes, unless noted otherwise, are American Wire Gauge (AWG)

Insulating covers are available for most connector sizes.

See page 165 for additional information on covers

De-Ox Inhibitor is recommended for all aluminum terminations.

Tested to UL 486A/B, UL File E6207

"T" Tap Connectors

Dual Rated - Lay-In

RoHS
Compliant

UL
LISTED
453G

CSA
LR-29601

TYPE
GTT

Features

- Manufactured from high strength 6061-T6 aluminum alloy
- Electro-tin plated
- UL Listed and CSA Certified for 600, 90° C/194° F
- Compact design
- Range taking
- Re-usable
- Lay-in main conductor
- Insulating cover available

Benefits

- Suitable for use with either copper or aluminum conductors
- Provides low contact resistance
- Ensures reliability for copper or aluminum conductors
- Saves space and reduces installation time
- Permits inventories to be kept to a minimum
- Provides efficient use and flexibility in the field
- No need to break the feeder cable
- Eliminates taping

C

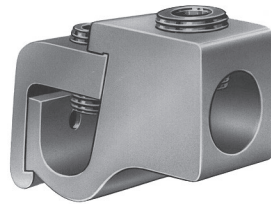
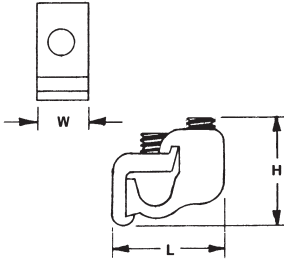

Fig. 1

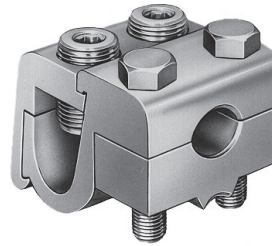
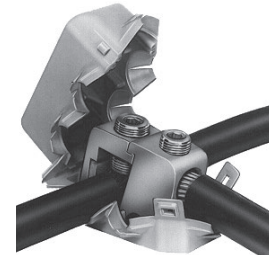

Fig. 2



| Catalog Number | Figure Number | Wire Range | | Dimensions (in.) | | | Hex Size | |
|----------------|---------------|-------------------|---------------------|------------------|-------|---------|----------|--------|
| | | Main | Tap | L | W | H | Main | Tap |
| GTT-2-2 | 1 | 2-12 str | 2-12 AL 2-14 CU | 1-1/4 | 9/16 | 1 | Slot | Slot |
| GTT-0-0 | 1 | 1/0-2 | 1/0-12 AL 1/0-14 CU | 1-9/16 | 3/4 | 1-1/8 | Slot | Slot |
| GTT-250-0 | 1 | 250kcmil-1/0 | 1/0-12 AL 1/0-14 CU | 2 | 7/8 | 1-7/16 | 5/16 | Slot |
| GTT-250-250 | 1 | 250kcmil-1/0 | 250kcmil-6 | 2-1/8 | 7/8 | 1-7/16 | 5/16 | 5/16 |
| GTT-350-350 | 1 | 350kcmil-4/0 | 350kcmil-6 | 2-7/16 | 1 | 1-11/16 | 3/8 | 3/8 |
| GTT-500-500 | 1 | 500kcmil-350kcmil | 500kcmil-2 | 2-15/16 | 1-1/4 | 2 | 3/8 | 3/8 |
| GTT-750-500 | 1 | 750kcmil-500kcmil | 500kcmil-2 | 3-3/8 | 1-1/4 | 2-7/16 | 3/8 | 3/8 |
| GTT-750-750 | 2 | 750kcmil-500kcmil | 750kcmil-600kcmil | 3-3/8 | 2-3/8 | 2-7/16 | 1/2 | EH 3/4 |

Note: If ordering with cover, add suffix W/C to catalog number.

All wire sizes, unless noted otherwise, are American Wire Gauge (AWG)

EH-External Hex

Insulating covers are available for most connector sizes.

See page 165 for additional information on covers

De-Ox Inhibitor is recommended for all aluminum terminations.

Tested to UL 486A/B, UL File E6207

Insulating Covers For GTA-GTT

RoHS
Compliant

UL
LISTED
453G

SA
LR-29601

TYPE GTC

Features

- Snap closure
- Color coded
- UL Listed and CSA Certified for 600 volts, 90° C/194° F except for GTPC-750-750 and GTTC-750-750

Benefits

- Installs quickly and saves labor time by eliminating taping
- Provides ease of identification in the field
- Ensures reliability



Fig. 1



Fig. 2



Fig. 3

C

| Catalog Number | Figure Number | Color | Dimensions (in.) | | | Used with Connector |
|----------------|---------------|-------|------------------|---------|---------|--------------------------------------------------------------------------------|
| | | | L | W | H | |
| GTC-2 | 1 | Black | 2-1/4 | 1-13/16 | 1-1/4 | GTA-2-2: GTT-2-2 |
| GTC-0 | 1 | Black | 2-1/2 | 2-3/32 | 1-3/8 | GTA-0-0: GTT-0-0 |
| GTC-250-350 | 1 | Black | 3-61/64 | 3-1/32 | 2 | GTA-250-0: GTA-250-250 GTA-350-350 GTT-250-0: GTT-250-250 GTT-350-350 |
| GTC-500 | 1 | Black | 4-1/8 | 3-1/16 | 2-31/32 | GTA-500-500 GTT-500-500 |
| GTC-750-500 | 1 | Black | 4-7/8 | 3-1/8 | 2-23/32 | GTA-750-500 GTT-750-500 |
| GTPC-750-750* | 2 | Black | 4-7/8 | 4 | 2-7/8 | GTA-750-750 |
| GTTC-750-750* | 3 | Black | 5-3/4 | 4-1/4 | 3-1/16 | GTT-750-750 |

All wire sizes, unless noted otherwise, are American Wire Gauge (AWG)

* Not UL Listed or CSA Certified

Tested to UL 486A/B, UL File E6207

Multiple Tap Connector

Dual Rated - Lay-In

RoHS
Compliant



TYPE
GT2

Features

- Manufactured from high strength 6061-T6 aluminum alloy
- Electro-tin plated
- UL Listed for 600 volts, 90° C/194° F
- Compact design
- Range taking
- Re-usable
- Lay-in main conductor
- Supplied with cover

Benefits

- Suitable for use with either copper or aluminum conductors
- Provides low contact resistance
- Ensures reliability for copper or aluminum conductors
- Saves space and reduces installation time
- Permits inventories to be kept to a minimum
- Provides efficient use and flexibility in the field
- No need to break the feeder cable
- Eliminates taping

C

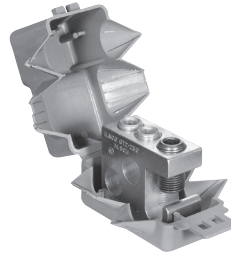
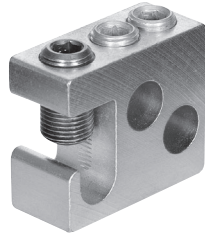
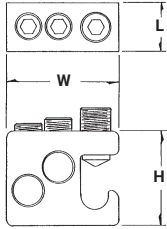

| Catalog Number | Wire Range Main & Tap | No. of Taps | Dimensions (in.) | | | Hex Size |
|----------------|-----------------------|-------------|------------------|--------|---------|----------|
| | | | L | W | H | |
| GT2-250-W/C | 250kcmil-2 | 2 | 31/32 | 2-9/32 | 1-15/16 | 5/16 |

All wire sizes, unless noted otherwise, are American Wire Gauge (AWG)
De-Ox Inhibitor is recommended for all aluminum terminations.
Tested to UL 486A/B, UL File E6207

Multiple Tap Connector

Dual Rated - Lay-In

RoHS
Compliant

UL
LISTED
453G

SA
LR-29601

TYPE GT4T

Features

- Manufactured from high strength 6061-T6 aluminum alloy
- Electro-tin plated
- UL Listed and CSA Certified for 600 volts, 90° C/194° F
- Compact design
- Range taking
- Re-usable
- Lay-in main conductor
- Insulating cover available

Benefits

- Suitable for use with either copper or aluminum conductors
- Provides low contact resistance
- Ensures reliability for copper or aluminum conductors
- Can make up to four taps off a single main which saves space and reduces installation time
- Permits inventories to be kept to a minimum
- Provides efficient use and flexibility in the field
- No need to break the feeder cable
- Eliminates taping

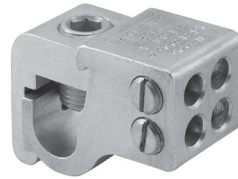
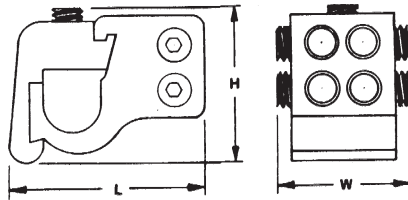

Fig. 1



Fig. 2

C

| Catalog Number | Figure Number | Wire Range | | No. of Taps | Dimensions (in.) | | | Hex Size | |
|----------------|---------------|-------------------|----------------------|-------------|------------------|-------|---------|----------|------|
| | | Main | Tap | | L | W | H | Main | Tap |
| GT4T-250-2-1* | 1 | 250kcmil-1/0 | 2-12 AL, 2-14 CU | 4 | 2-3/16 | 1-1/8 | 1-35/64 | 5/16 | Slot |
| GT4T-250-2-2* | 2 | 250kcmil-1/0 | 2-12 AL, 2-14 CU | 4 | 2-3/16 | 1-1/8 | 1-35/64 | 5/16 | Slot |
| GT4T-350-2-1† | 1 | 350kcmil-4/0 | 2-12 AL, 2-14 CU | 4 | 2-17/32 | 1-1/8 | 1-17/32 | 3/8 | Slot |
| GT4T-350-2-2* | 2 | 350kcmil-4/0 | 2-12 AL, 2-14 CU | 4 | 2-17/32 | 1-1/8 | 1-17/32 | 3/8 | Slot |
| GT4T-500-2-1† | 1 | 500kcmil-350kcmil | 2-12 AL, 2-14 CU | 4 | 2-31/32 | 1-1/4 | 1-11/16 | 3/8 | Slot |
| GT4T-500-2-2† | 2 | 500kcmil-350kcmil | 2-12 AL, 2-14 CU | 4 | 2-31/32 | 1-1/4 | 1-11/16 | 3/8 | Slot |
| GT4T-500-0-1† | 1 | 500kcmil-350kcmil | 1/0-12 AL, 1/0-14 CU | 4 | 2-31/32 | 1-1/4 | 1-11/16 | 3/8 | Slot |
| GT4T-500-0-2† | 2 | 500kcmil-350kcmil | 1/0-12 AL, 1/0-14 CU | 4 | 2-31/32 | 1-1/4 | 1-11/16 | 3/8 | Slot |

All wire sizes, unless noted otherwise, are American Wire Gauge (AWG)

* GTC-250-350 Cover can be used. See page 165.

† GTC-500 Cover can be used. See page 165.

De-Ox Inhibitor is recommended for all aluminum terminations.

Tested to UL 486A/B, UL File E6207

Multiple Tap Connector

Dual Rated - Lay-In

RoHS
Compliant

TYPE MGTT

Features

- Manufactured from high strength 6061-T6 aluminum alloy
- Electro-tin plated
- Dual-Rated
- Compact design
- Range taking
- Re-usable
- Lay-in main conductor

Benefits

- Suitable for use with either copper or aluminum conductors
- Provides low contact resistance
- Can be used with copper and/or aluminum conductors
- Saves space and reduces installation time
- Permits inventories to be kept to a minimum
- Provides efficient use and flexibility in the field
- No need to break the feeder cable

C

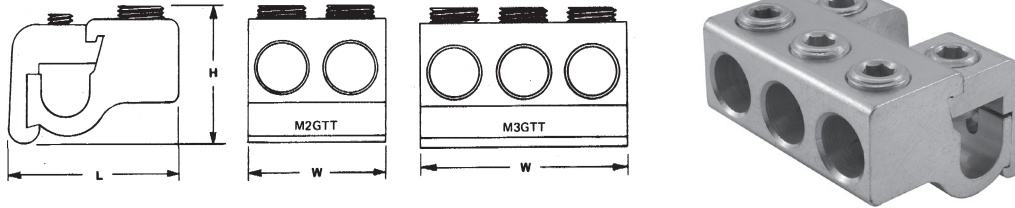

| Catalog Number | Wire Range | | No. of Tap Openings | Dimensions (in.) | | | Hex Size | |
|----------------|-------------------|------------|---------------------|------------------|-------|---------|----------|------|
| | Main | Tap | | L | W | H | Main | Tap |
| M2GTT-250-250 | 250kcmil-1/0 | 250kcmil-6 | 2 | 2 | 1-3/4 | 1-5/8 | 5/16 | 5/16 |
| M2GTT-350-350 | 350kcmil-4/0 | 350kcmil-6 | 2 | 2-1/4 | 2 | 1-11/16 | 5/16 | 5/16 |
| M3GTT-350-350 | 350kcmil-4/0 | 350kcmil-6 | 3 | 2-1/4 | 3 | 1-11/16 | 5/16 | 5/16 |
| M2GTT-500-500 | 500kcmil-350kcmil | 500kcmil-2 | 2 | 2-3/4 | 2-3/8 | 1-13/16 | 3/8 | 3/8 |
| M3GTT-500-500 | 500kcmil-350kcmil | 500kcmil-2 | 3 | 2-3/4 | 3-1/2 | 1-13/16 | 3/8 | 3/8 |

All wire sizes, unless noted otherwise, are American Wire Gauge (AWG)
De-Ox Inhibitor is recommended for all aluminum terminations.

Multiple Tap Connector

Dual Rated

RoHS
Compliant



TYPE PTA

Features

- Manufactured from high strength 6061-T6 aluminum alloy
- Electro-tin plated
- UL Listed and CSA Certified for 600 volts, 90° C/194° F
- Compact design
- Range taking
- Re-usable
- Lay-in main conductors
- Supplied with insulating cover

Benefits

- Suitable for use with either copper or aluminum conductors
- Provides low contact resistance
- Ensures reliability for copper or aluminum conductors
- Saves space and reduces installation time
- Permits inventories to be kept to a minimum
- Provides efficient use and flexibility in the field
- No need to break the feeder cables
- Eliminates taping



Fig. 1

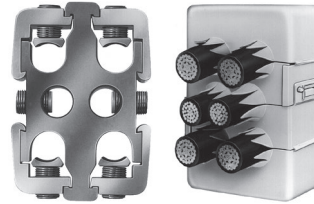
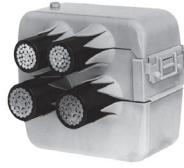

Fig. 2



Fig. 3

C

| Catalog Number | Figure Number | Wire Range | | Dimensions (in.) | | | Hex Size | |
|------------------|---------------|-------------------------|--------------------------|------------------|--------|--------|----------|-----------------|
| | | Main | Tap | H | W | D | Main | Tap |
| PTA2-500-500-w/c | 1 | Two: 500kcmil-250kcmil | Two: 500kcmil-4 | 3-15/16 | 3-1/2 | 1-1/4 | 3/8 | 3/8 |
| PTA2-750-500-w/c | 1 | Two: 750kcmil-350kcmil | Two: 500kcmil-4 | 3-5/8 | 4-3/32 | 1-5/16 | 3/8 | 3/8 |
| PTA4-750-500-w/c | 2 | Four: 750kcmil-350kcmil | Two: 500kcmil-4 | 5-7/8 | 4-3/32 | 1-5/16 | 3/8 | 3/8 |
| PTA26-500-4/0*+ | 3 | Two: 500kcmil-4/0 | Four: 4/0-6 Two: 2-14 | 3-15/16 | 3-1/2 | 1-1/4 | 3/8 | 5/16 Slotted |

All wire sizes, unless noted otherwise, are American Wire Gauge (AWG)

Note: W/C indicates product is supplied with insulating cover.

* Not CSA Certified.

+ Cover must be ordered separately. For non UL cover, order 1 each RO614W00A and RO615W00A.

De-Ox Inhibitor is recommended for all aluminum terminations.

Tested to UL 486A/B, UL File E6207

nVent ILSCO MAC Block Multi-Wire Tap and Splice

For Adding Branch Connections and Light Industrial Applications



TYPE MAC

Features

- Retrofit aluminum to copper connections
- Widest conductor range in the industry
- Set screw connections
- Dual rated
- IP20 touch safe protection
- Multiple conductor sizes per port
- Eliminates pigtails
- Accepts flex conductors
- Certified for power and grounding
- Connector rated to 90° C/194° F, 300 volts
- Insulated cover rated to 105° C/221° F
- Runs 35° F/1° C cooler than leading twist-on connectors
- Secureness strength 2.5 times higher than leading twist-ons

Benefits

- For AL to AL, AL to CU, and CU to CU conductor
- One connector satisfies the need for five twist-on connectors
- More secure and reliable than twist on connectors
- For copper or aluminum conductor
- Minimizes risk of electrical shock
- Can mix various sizes, e.g. 1 #18 & 1#12
- Up to 4 #14 AWG conductors per port
- For motors and commercial applications
- Application versatility
- Ensures reliability

C

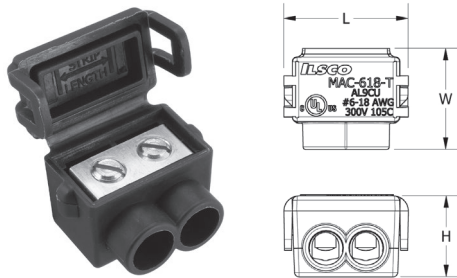

Fig. 1

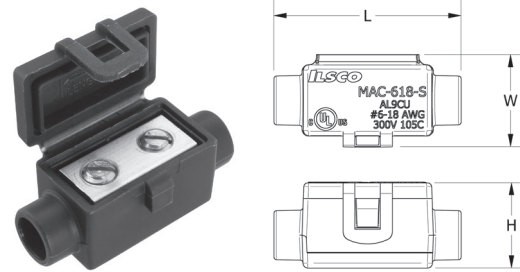

Fig. 2

| Catalog Number | MAC Block | | | | | Overall Dimensions - in. (mm) | | |
|----------------|-----------|-------------|--------------------|--------------------|----------------------|-------------------------------|--------------|--------------|
| | Color | Fig. Number | CU Conductor Range | AL Conductor Range | Flex Conductor Range | W | H | L |
| MAC-618-T-K | Black | 1 | #6-#18 | #6-#12 | #6-#14 | 0.84 (21.3) | 0.689 (17.5) | 1.04 (26.4) |
| MAC-618-S-K | Black | 2 | #6-#18 | #6-#12 | #6-#14 | 0.7 (17.8) | 0.689 (17.5) | 1.488 (37.8) |

All wire sizes, unless noted otherwise, are American Wire Gauge
 Dissimilar conductor materials cannot be used in the same port
 Tested to UL 486A/B, UL File E6207
 Tested to UL 467, UL File E6207

nVent ILSCO KUP-L-Tap Insulation Piercing Connectors Dual Rated



TYPE IPC



Features

- Body is molded from tough, resilient glass-filled nylon
- Compact design
- Tin plated copper contact teeth
- Insulation piercing
- Perforated end tabs
- Pre-filled with silicone lubricant
- Versatile
- Increased safety
- Horizontal line grid
- Temperature rating 90° C/194° F

Benefits

- Provides high degree of breakage resistance and long dependable use
- Saves space
- Easily penetrates most types of insulation
- No need to strip the conductor which saves installation time
- Break out easily by hand
- Prevents oxidation and moisture from entering the contact area
- Can be used as a splice or tap connector
- Contains no external energized parts. Can be installed "hot" on energized conductors providing tap conductor is not under load.
- Provides a visual guide for proper installation of conductors

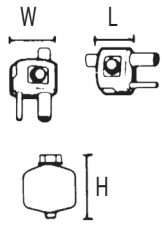

Fig. 1



Fig. 2



Fig. 3



Fig. 4



| Catalog Number | Fig. No. | Wire Range | | Volts | Current Rating | | Dimensions (in.) | | | Torque Ft. Lbs. | Bolt Head Size |
|----------------|----------|-------------------|-------------------|-----------------------------|----------------|-----|------------------|---------|---------|-----------------|----------------|
| | | Main | Tap | | CU | AL | L | W | H | | |
| IPC-1/0-2 | 3 | 1/0-8 | 2-8 | 300 (480 Grounded Y System) | 130 | 100 | 1-7/32 | 1-15/32 | 2-5/16 | 16 | 1/2 |
| IPC-4/0-6 | 2 | 4/0-4 | 6-14 | 600 | 75 | 60 | 1-27/64 | 1 | 1-7/8 | 13 | 1/2 |
| IPC-4/0-2/0 | 3 | 4/0-2 | 2/0-6 | 600 | 195 | 150 | 1-21/32 | 1-7/8 | 2-7/8 | 25 | 1/2 |
| ipc-250-4/0 | 2 | 250kcmil-1 | 4/0-6 | 600 | 260 | 205 | 1-7/8 | 2-11/32 | 3-11/32 | 30 | 5/8 |
| ipc-350-4/0 | 3 | 350kcmil-4/0 | 4/0-10 | 300 (480 Grounded Y System) | 260 | 205 | 1-43/64 | 2-7/16 | 3-1/8 | 25 | 5/8 |
| ipc-350-350 | 4 | 350kcmil-4/0 | 350kcmil-4/0 | 300 (480 Grounded Y System) | 350 | 280 | 2-43/64 | 2-23/32 | 3-1/4 | 25 | 5/8 |
| ipc-500-12 | 1 | 500kcmil-250kcmil | 10-12 | 300 (480 Grounded Y System) | 40 | 35 | 1-43/64 | 2-7/16 | 3-1/4 | 25 | 5/8 |
| ipc-500-250 | 1 | 500kcmil-250kcmil | 250kcmil-4 | 600 | 290 | 230 | 2-27/64 | 2-29/32 | 3-3/4 | 55 | 5/8-11/16 |
| ipc-500-500 | 1 | 500kcmil-300kcmil | 500kcmil-250kcmil | 600 | 430 | 350 | 3-3/16 | 3-5/8 | 5 | 75 | 7/8-7/8 |
| ipc-750-500 | 1 | 750kcmil-500kcmil | 500kcmil-350kcmil | 600 | 430 | 350 | 3-3/16 | 3-5/8 | 5 | 75 | 7/8-7/8 |

All wire sizes, unless noted otherwise, are American Wire Gauge (AWG)

Tested to UL 486A/B, UL File E6207

Not for use with cloth insulated conductor type TCCW

Ground Lug

Lay-In - Dual Rated

RoHS
Compliant

UL
LISTED
667P

SA
LR-29601

TYPE SGB

Features

- Manufactured from high strength 6061-T6 aluminum alloy
- Electro-tin plated
- Lay-in feature
- Exclusive Viritium plating
- Green color universal to identify ground
- Serrations in conductor wire way
- Unique clamp design
- 1/4 in max frame thickness (SGB-4, SGB-5)
- Meets ASTM B117-09

Benefits

- Suitable for use with copper or aluminum conductors
- Provides low contact resistance
- Provides ease of installation
- Resists galvanic corrosion
- Aids visual inspection
- Cuts oxidation
- No mounting hardware required, reusable
- Mount to solar panel frames
- Resistance to outdoor salt spray

C

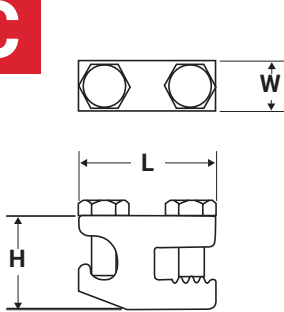

Fig. 1

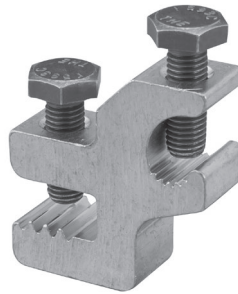

Fig. 2

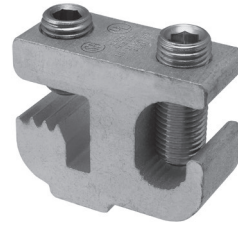

Fig. 3

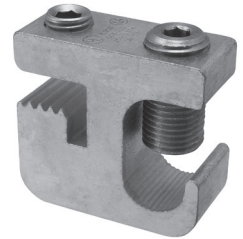

Fig. 4

| Catalog Number | Figure Number | Ground Wire Range | Dimensions - in. (mm) | | | Hex Size |
|----------------|---------------|------------------------|-----------------------|--------------|--------------|----------|
| | | | L | W | H | |
| SGB-4+ | 1 | 4 sol/str-14 sol/str | 1.375 (34.9) | 0.500 (12.7) | 0.941 (23.9) | 7/16 |
| SGB-5+ | 2 | 4 sol/str-14 sol/str | 1.375 (34.9) | 0.500 (12.7) | 1.440 (36.6) | 7/16 |
| SGB-1/0 | 3 | 1/0 sol/str-14 sol/str | 1.508 (38.3) | 0.625 (15.9) | 1.241 (31.5) | 3/16 |
| SGB-250 | 4 | 250kcmil-6 | 1.810 (46.0) | 0.750 (19.1) | 1.703 (43.3) | 3/16 |

All wire sizes, unless noted otherwise, are American Wire Gauge (AWG)

UL 467 for grounding and bonding. UL File E34440

+ UL2703 Recognized E354420 Vol. 1

De-Ox oxide inhibitor is recommended for all aluminum terminations

Patented

nVent ILSCO PermaGround

Ground Clamp Connectors

Double Wire, One Bolt



TYPE

GH
GHS

Features

- Manufactured from copper alloy
- Furnished with silicon bronze bolt, nut, and lock washer
- Mountable for surfaces up to 1/4 in thick
- UL 467 Listed for grounding and bonding up to 250kcmil

Benefits

- Provides maximum conductivity
- For clamping conductors to flat surfaces
- Fits standard grounding bus bar and various flat plate metal surfaces
- Suitable for direct burial in earth or concrete

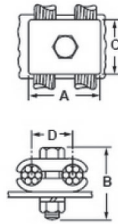

Fig. 1

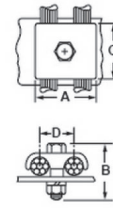

Fig. 2

C

| Catalog Number | Figure Number | Wire Range | Dimensions - in. (mm) | | | | Bolt Size |
|----------------|---------------|--------------------|-----------------------|--------------|--------------|--------------|-----------|
| | | | A | B | C | D | |
| GH-6 | 1 | 1000kcmil-750kcmil | 3.625 (92.1) | 3.750 (95.3) | 2.500 (63.5) | 2.000 (50.8) | 5/8 |
| GHS-1* | 2 | 4str-8sol | 1.250 (31.8) | 1.375 (34.9) | 1.375 (34.9) | 0.750 (19.1) | 3/8 |
| GHS-5 | 2 | 750kcmil-500kcmil | 3.250 (82.6) | 2.750 (69.9) | 2.375 (60.3) | 1.750 (44.5) | 5/8 |

All wire sizes, unless noted otherwise, are American Wire Gauge (AWG)
*UL File E158587

PermaGround

Ground Clamp Connectors

Single Wire



TYPE
GMS
GWL

Features

- Manufactured from copper alloy
- Furnished with silicon bronze bolt, nut, and lock washer
- Mountable for surfaces up to 1/4 in thick
- UL 467 Listed for grounding and bonding up to 250kcmil as well as UL 486 A/B

Benefits

- Provides maximum conductivity
- For clamping conductors to flat surfaces
- Fits standard grounding bus bar and various flat plate metal surfaces
- Suitable for direct burial in earth or concrete

C

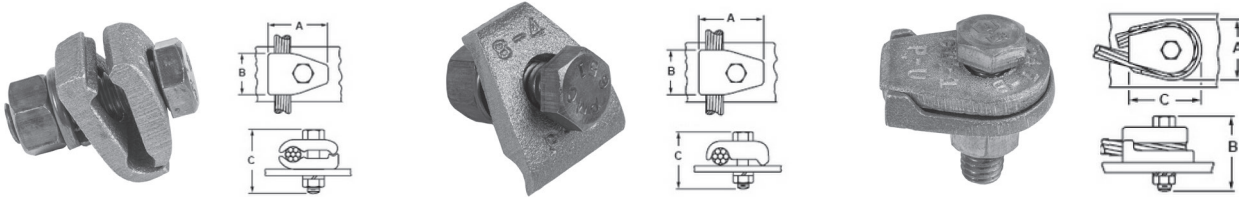

Fig. 1

Fig. 2

Fig. 3

| Catalog Number | Figure Number | Wire Range | Dimensions - in. (mm) | | | Bolt Size |
|----------------|---------------|--------------------|-----------------------|--------------|--------------|-----------|
| | | | A | B | C | |
| GMS-6* | 2 | 1000kcmil-750kcmil | 3.500 (88.9) | 1.875 (47.6) | 3.125 (79.4) | 5/8 |
| GWL-1 | 3 | 4str-8sol | 1.125 (28.6) | 1.500 (38.1) | 1.375 (34.9) | 3/8 |
| GWL-2 | 3 | 4str-8sol | 1.750 (44.5) | 1.750 (44.5) | 1.875 (47.6) | 1/2 |
| GWL-6 | 3 | 250kcmil-3/0str | 2.250 (57.2) | 2.375 (60.3) | 2.375 (60.3) | 1/2 |
| GWL-7 | 3 | 250kcmil-3/0str | 2.250 (57.2) | 2.500 (63.5) | 2.375 (60.3) | 5/8 |

All wire sizes, unless noted otherwise, are American Wire Gauge (AWG)

*UL File E158587

PermaGround

Ground Clamp Connectors

Two Parallel Cables of Wires to Pipe or Rod



TYPE
GT

Features

- Manufactured from copper alloy
- Furnished with silicon bronze nut, and lock washer
- UL 467 Listed for grounding and bonding up to 250kcmil

Benefits

- Provides maximum conductivity
- For clamping parallel cable and wires to pipe or rod in perpendicular orientation
- Suitable for direct burial in earth or concrete

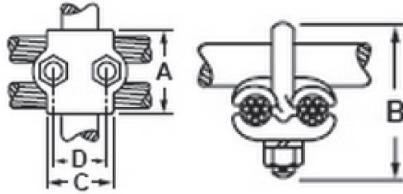

C

| Catalog Number | Accommodates | | Wire Range | Dimensions - in. (mm) | | | | Bolt Size |
|----------------|--------------|----------------|-----------------|-----------------------|---------------|---------------|---------------|-----------|
| | Rod | Iron Pipe Size | | A | B | C | D | |
| GT-3* | 1/2 | 1/4 | 250kcmil-2/0sol | 2.500 (63.5) | 2.250 (57.2) | 1.875 (47.6) | 1.000 (25.4) | 3/8 |
| GT-4* | 5/8 or 3/4 | 3/8 | 4str-8sol | 1.625 (41.3) | 2.125 (54.0) | 1.625 (41.3) | 1.125 (28.6) | 3/8 |
| GT-8* | 7/8 or 1 | 1/2 or 3/4 | 4str-8sol | 1.625 (41.3) | 2.500 (63.5) | 1.625 (41.3) | 1.500 (38.1) | 3/8 |
| GT-13* | - | 1 | 4str-8sol | 1.625 (41.3) | 2.750 (69.9) | 1.625 (41.3) | 1.750 (44.5) | 3/8 |
| GT-14* | - | 1 | 2/0str-4sol | 2.000 (50.8) | 3.000 (76.2) | 1.750 (44.5) | 1.750 (44.5) | 3/8 |
| GT-15* | - | 1 | 250kcmil-2/0sol | 2.500 (63.5) | 3.875 (98.4) | 3.125 (79.4) | 1.750 (44.5) | 3/8 |
| GT-18* | - | 1 1/4 | 4str-8sol | 1.625 (41.3) | 3.000 (76.2) | 1.875 (47.6) | 2.063 (52.4) | 3/8 |
| GT-19* | - | 1 1/4 | 2/0str-4sol | 2.000 (50.8) | 3.250 (82.6) | 2.000 (50.8) | 2.063 (52.4) | 3/8 |
| GT-20* | - | 1 1/4 | 250kcmil-2/0sol | 2.500 (63.5) | 3.500 (88.9) | 2.125 (54.0) | 2.063 (52.4) | 3/8 |
| GT-25* | - | 1 1/2 | 2/0str-4sol | 2.000 (50.8) | 3.500 (88.9) | 2.375 (60.3) | 2.375 (60.3) | 3/8 |
| GT-26* | - | 1 1/2 | 250kcmil-2/0sol | 2.500 (63.5) | 3.875 (98.4) | 2.500 (63.5) | 2.375 (60.3) | 3/8 |
| GT-30* | - | 2 | 4str-8sol | 1.750 (44.5) | 3.875 (98.4) | 2.750 (69.9) | 2.813 (71.4) | 3/8 |
| GT-31* | - | 2 | 2/0str-4sol | 2.000 (50.8) | 4.125 (104.8) | 2.875 (73.0) | 2.813 (71.4) | 3/8 |
| GT-32* | - | 2 | 250kcmil-2/0sol | 2.625 (66.7) | 4.250 (108.0) | 3.000 (76.2) | 2.813 (71.4) | 3/8 |
| GT-37* | - | 2 1/2 | 2/0str-4sol | 2.000 (50.8) | 4.500 (114.3) | 3.375 (85.7) | 3.313 (84.1) | 3/8 |
| GT-38* | - | 2 1/2 | 250kcmil-2/0sol | 2.625 (66.7) | 4.750 (120.7) | 3.500 (88.9) | 3.313 (84.1) | 3/8 |
| GT-43* | - | 3 | 2/0str-4sol | 2.000 (50.8) | 5.250 (133.4) | 3.750 (95.3) | 3.938 (100.0) | 3/8 |
| GT-44* | - | 3 | 250kcmil-2/0sol | 2.625 (66.7) | 5.500 (139.7) | 3.750 (95.3) | 3.938 (100.0) | 3/8 |
| GT-49* | - | 3 1/2 | 2/0str-4sol | 2.000 (50.8) | 5.875 (149.2) | 3.875 (98.4) | 4.438 (112.7) | 3/8 |
| GT-50* | - | 3 1/2 | 250kcmil-2/0sol | 2.625 (66.7) | 6.125 (155.6) | 4.000 (101.6) | 4.438 (112.7) | 3/8 |
| GT-55* | - | 4 | 250kcmil-2/0sol | 2.625 (66.7) | 6.500 (165.1) | 4.750 (120.7) | 4.938 (125.4) | 3/8 |

All wire sizes, unless noted otherwise, are American Wire Gauge (AWG)
*UL File E158587

PermaGround Eye-Bolt Terminal

TYPE
LS
LSN

Features

- Body is manufactured from copper alloy
- Eye-bolts are made from an aluminum bronze alloy
- Available in two mounting surface thickness ranges

Benefits

- Provides maximum conductivity
- Offers maximum strength
- Mountable to flat studs or spades on equipment as well as grounding conductor to steel substation structures

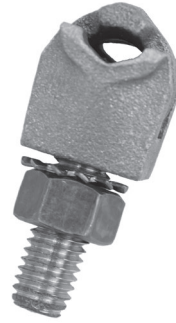
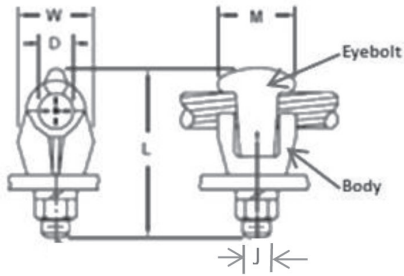

C

| Catalog Number | Wire Range | Dimensions - in. (mm) | | | | | Hex |
|----------------|------------------|-----------------------|---------------|--------------|--------------|-----|------|
| | | D | L | M | W | J | |
| LSN-2/0N* | 2/0str-8sol | 0.438 (11.1) | 2.375 (60.3) | 1.375 (34.9) | 1.000 (25.4) | 1/2 | 3/4 |
| LSN-025N* | 250kcmil-6sol | 0.625 (15.9) | 2.563 (65.1) | 1.250 (31.8) | 1.063 (27.0) | 1/2 | 3/4 |
| LSN-035N* | 350kcmil-2sol | 0.813 (20.6) | 3.063 (77.8) | 1.250 (31.8) | 1.313 (33.3) | 1/2 | 3/4 |
| LS-C1E+ | 1str-10sol | 0.344 (8.73) | 2.375 (60.3) | 1.063 (27.0) | 0.875 (22.2) | 3/8 | 9/16 |
| LSN-025NE+ | 250kcmil-6sol | 0.625 (15.88) | 3.063 (77.8) | 1.250 (31.8) | 1.063 (27.0) | 1/2 | 3/4 |
| LSN-035NE+ | 350kcmil-2sol | 0.813 (20.64) | 3.313 (84.1) | 1.250 (31.8) | 1.313 (33.3) | 1/2 | 3/4 |
| LSN-100NE+ | 1000kcmil-2/0sol | 1.250 (31.75) | 4.500 (114.3) | 1.719 (43.7) | 1.688 (42.9) | 1/2 | 3/4 |

All wire sizes, unless noted otherwise, are American Wire Gauge (AWG)

"N" in prefix qualifies terminal for mounting on NEMA pads

"N" in suffix qualifies eye-bolt opening to NEMA

*Up to a 1/4 in mounting surface

+1/4 in to 3/4 in mounting surface

Aluminum Multi-Tap Connectors

Dual Rated

RoHS
Compliant



TYPE PED-Z

Features

- Available in two, four, six, or eight conductor configurations in four wire ranges
- Manufactured from high strength 6061-T6 aluminum alloy
- Compact size
- Rated for 600 volts, 90° C/194° F

Benefits

- Provides multiple conductor installation for a wide range of conductors
- Suitable for use with either copper or aluminum conductors
- Suitable for pedestal applications

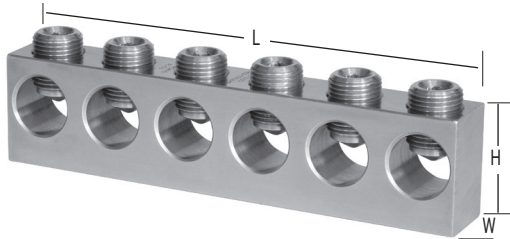

C

| Catalog Number | Connector Design | Number of Ports | Wire Range | Dimensions (in.) | | | Hex Size |
|----------------|------------------|-----------------|------------|------------------|------|------|----------|
| | | | | A | B | E | |
| PED-2-2/0-Z | | 2 | 2/0-14 | 2.09 | .56 | .73 | 3/16 |
| PED-4-2/0-Z | | 4 | 2/0-14 | 3.78 | .56 | .73 | 3/16 |
| PED-6-2/0-Z | | 6 | 2/0-14 | 5.46 | .56 | .73 | 3/16 |
| PED-8-2/0-Z | | 8 | 2/0-14 | 7.15 | .56 | .73 | 3/16 |
| PED-2-4/0-Z | | 2 | 4/0-6 | 1.78 | .75 | 1.00 | 5/16 |
| PED-4-4/0-Z | | 4 | 4/0-6 | 3.64 | .75 | 1.00 | 5/16 |
| PED-6-4/0-Z | | 6 | 4/0-6 | 5.50 | .75 | 1.00 | 5/16 |
| PED-8-4/0-Z | | 8 | 4/0-6 | 7.36 | .75 | 1.00 | 5/16 |
| PED-2-350-Z | | 2 | 350kcmil-6 | 2.22 | 1.00 | 1.25 | 5/16 |
| PED-4-350-Z | | 4 | 350kcmil-6 | 4.53 | 1.00 | 1.25 | 5/16 |
| PED-6-350-Z | | 6 | 350kcmil-6 | 6.84 | 1.00 | 1.25 | 5/16 |
| PED-8-350-Z | | 8 | 350kcmil-6 | 9.15 | 1.00 | 1.25 | 5/16 |
| PED-2-600-Z | | 2 | 600kcmil-4 | 2.47 | 1.25 | 1.63 | 3/8 |
| PED-4-600-Z | | 4 | 600kcmil-4 | 5.03 | 1.25 | 1.63 | 3/8 |
| PED-6-600-Z | | 6 | 600kcmil-4 | 7.59 | 1.25 | 1.63 | 3/8 |
| PED-8-600-Z | | 8 | 600kcmil-4 | 10.16 | 1.25 | 1.63 | 3/8 |

All wire sizes, unless noted otherwise, are American Wire Gauge (AWG)
Covers not available. De-Ox Inhibitor is recommended for all aluminum terminations.

Aluminum Multi-Tap Connectors

Dual Rated

RoHS
Compliant

TYPE
PED-X
PSA-Z
PEC

Features

- Available in four, six, or eight conductor configurations in four wire ranges
- Plastisol insulating cover available with a nominal thickness of 156 Mils
- Manufactured from high strength 6061-T6 aluminum alloy
- Compact size

Benefits

- Provides multiple conductor installation for a wide range of conductors
- Eliminates the need for taping. Plastisol covers have dielectric strength of 120 volts per Mil
- Suitable for use with either copper or aluminum conductors
- Suitable for pedestal applications

C

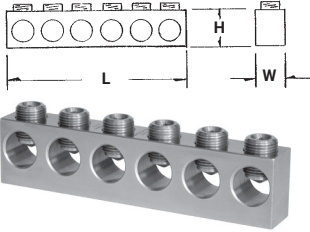

Fig. 1

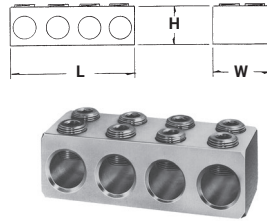

Fig. 2



| Catalog Number | Figure Number | Wire Range | No. of Conductors | Dimensions - in. (mm) | | | Hex Size | Recommended Torque | Bolt Size |
|----------------|---------------|--------------|-------------------|-----------------------|---|-------|----------|--------------------|-----------|
| | | | | L | W | H | | | |
| PED-4-350-X | 1 | 350kcmil-10 | 4 | 3-7/8 | 1 | 1-3/8 | 5/16 | 350 | PEC-4-350 |
| PED-6-350-X | 1 | 350kcmil-10 | 6 | 5-11/16 | 1 | 1-3/8 | 5/16 | 350 | PEC-6-350 |
| PED-8-350-X | 1 | 350kcmil-10 | 8 | 7-1/2 | 1 | 1-3/8 | 5/16 | 350 | PEC-8-350 |
| PED-4-500-X | 1 | 500kcmil-10 | 4 | 4-3/4 | 1 | 1-5/8 | 5/16 | 450 | PEC-4-500 |
| PED-6-500-X | 1 | 500kcmil-10 | 6 | 7-1/4 | 1 | 1-5/8 | 5/16 | 450 | PEC-6-500 |
| PED-8-500-X | 1 | 500kcmil-10 | 8 | 9-11/16 | 1 | 1-5/8 | 5/16 | 450 | PEC-8-500 |
| PSA-4-750-Z | 2 | 750kcmil-1/0 | 4 | 6-9/16 | 2 | 2-1/2 | 3/8 | 500 | PSC-4-750 |
| PSA-6-750-Z | 2 | 750kcmil-1/0 | 6 | 9-7/8 | 2 | 2-1/2 | 3/8 | 500 | PSC-6-750 |
| PSA-8-750-Z | 2 | 750kcmil-1/0 | 8 | 13-3/16 | 2 | 2-1/2 | 3/8 | 500 | PSC-8-750 |

All wire sizes, unless noted otherwise, are American Wire Gauge (AWG)
De-Ox Inhibitor is recommended for all aluminum terminations.

Aluminum Spade Type Transformer Lugs

Dual Rated

TYPE PET

Features

- Available in four, six, or eight conductor configurations in four wire ranges
- Predrilled 1/2 in mounting holes
- Manufactured from high strength 6061-T6 aluminum alloy

Benefits

- Provides multiple conductor installation for a wide range of conductors
- Allows easy attachment. May be bolted back to back for heavy duty applications
- Suitable for use with either copper or aluminum conductors

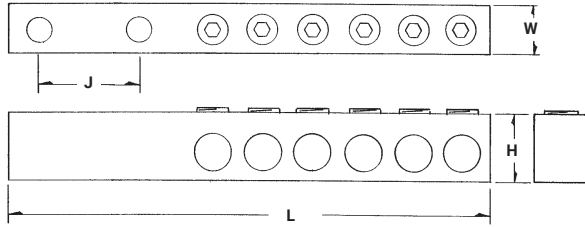

C

| Catalog Number | Wire Range | No. of Conductors | Bolt Size | Diameter of Mounting Hole | Dimensions (in.) | | | | Hex Size | Recommended Torque-Inch Lbs. |
|----------------|--------------|-------------------|-----------|---------------------------|------------------|-------|--------|----------|----------|------------------------------|
| | | | | | H | J | W | L | | |
| PET-4-350-Z | 350kcmil-10 | 4 | 1/2 | 9/16 | 1-3/8 | 1-3/4 | 1 | 6-7/8 | 5/16 | 350 |
| PET-6-350-Z | 350kcmil-10 | 6 | 1/2 | 9/16 | 1-3/8 | 1-3/4 | 1 | 8-11/16 | 5/16 | 350 |
| PET-8-350-Z | 350kcmil-10 | 8 | 1/2 | 9/16 | 1-3/8 | 1-3/4 | 1 | 10-1/2 | 5/16 | 350 |
| PET-4-500-Z | 500kcmil-2 | 4 | 1/2 | 9/16 | 1-5/8 | 1-3/4 | 1 | 7-15/16 | 5/16 | 450 |
| PET-6-500-Z | 500kcmil-2 | 6 | 1/2 | 9/16 | 1-1/8 | 1-3/4 | 1 | 10-3/16 | 5/16 | 450 |
| PET-8-500-Z | 500kcmil-2 | 8 | 1/2 | 9/16 | 1-5/8 | 1-3/4 | 1 | 12-7/16 | 5/16 | 450 |
| PET-4-750-Z | 750kcmil-1/0 | 4 | 1/2 | 9/16 | 1-3/4 | 1-3/4 | 1-3/16 | 8-11/16 | 3/8 | 500 |
| PET-6-750-Z | 750kcmil-1/0 | 6 | 1/2 | 9/16 | 1-3/4 | 1-3/4 | 1-3/16 | 11-15/16 | 3/8 | 500 |
| PET-8-750-Z | 750kcmil-1/0 | 8 | 1/2 | 9/16 | 1-3/4 | 1-3/4 | 1-3/16 | 13-15/16 | 3/8 | 500 |

All wire sizes, unless noted otherwise, are American Wire Gauge (AWG)
De-Ox Inhibitor is recommended for all aluminum terminations.

Aluminum Multi-Tap Adaptor Lugs

Dual Rated - (Pole Type Transformer Lugs)

TYPE
PTT

Features

- Connector manufactured from high strength 6061-T6 aluminum alloy
- Stud manufactured from electrolytic pure copper rod
- Two conductor ports
- Range taking
- Left or Right handed
- Clear Plated

Benefits

- Suitable for use with either copper or aluminum conductors
- Provides maximum conductivity and can be used on equipment with copper or aluminum connectors
- Allows parallel conductors to be connected to pole type transformers
- A wide range of conductor sizes can be used in each connector
- Provides ease of installation
- Provides low contact resistance

C

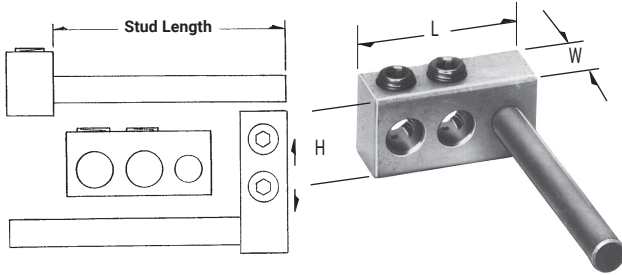

Fig. 1

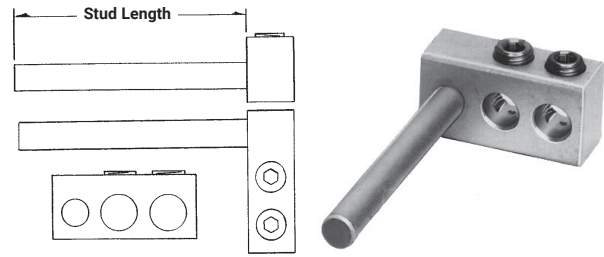

Fig. 2

| Catalog Number | Figure Number | Wire Range | No. of Conductors | Copper Stud Diameter | Stud Length | Hex Size | Dimensions - in. (mm) | | | Recommended Torque-Inch Lbs. |
|----------------|---------------|-------------|-------------------|----------------------|-------------|----------|-----------------------|------|------|------------------------------|
| | | | | | | | L | W | H | |
| PTT-2R-0-Z | 1 | 1/0-14 | 2 | 3/8 | 3 in | 3/16 | 1.87 | .75 | 1.00 | 200 |
| PTT-2L-0-Z | 2 | 1/0-14 | 2 | 3/8 | 3 in | 3/16 | 1.87 | .75 | 1.00 | 200 |
| PTT-2R-250-Z | 1 | 250kcmil-10 | 2 | 1/2 | 4 in | 5/16 | 2.39 | .90 | 1.12 | 300 |
| PTT-2L-250-Z | 2 | 250kcmil-10 | 2 | 1/2 | 4 in | 5/16 | 2.39 | .90 | 1.12 | 300 |
| PTT-2R-350-Z | 1 | 350kcmil-10 | 2 | 5/8 | 4 in | 5/16 | 3.25 | 1.25 | 1.25 | 350 |
| PTT-2L-350-Z | 2 | 350kcmil-10 | 2 | 5/8 | 4 in | 5/16 | 3.25 | 1.25 | 1.25 | 350 |

All wire sizes, unless noted otherwise, are American Wire Gauge (AWG)
De-Ox Inhibitor is recommended for all aluminum terminations.

Aluminum Neutral Bars

Dual Rated



TYPE NB

Features

- Preassembled, stacked neutral bars
- Available with phenolic base
- Electro-tin plated
- Fabricated from high strength 6061-T6 aluminum alloy

Benefits

- Compact, space saving design offers multiple range taking flexibility and is suitable for grounding applications
- Provides insulation from mounting surface
- Provides low contact resistance
- Suitable for use with either copper or aluminum conductors

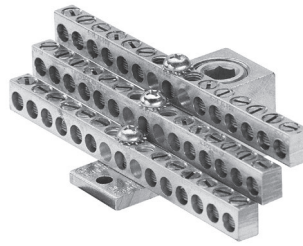
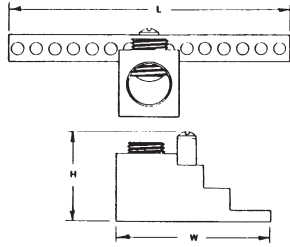

Fig. 1

Fig. 2

| Catalog Number | Fig. No. | Number of Circuit Taps | Wire Range | | Dimensions (in.) | | | Two Tapped Mounting Holes | Hex Size | |
|------------------|----------|------------------------|--------------|------------|-------------------------------|---------|---------|---------------------------|----------|------|
| | | | Circuit Taps | Line Loads | Approx. Height with Max. Wire | L | W | | Main | Tap |
| NB-350-12 | 1 | 12 | 14-4 | 350kcmil-6 | 1-17/32 | 4-23/32 | 2-17/32 | 10-32 | 3/8 | Slot |
| NB-350-12-W/R16* | 2 | 12 | 14-4 | 350kcmil-6 | 2-17/32 | 4-23/32 | 2-17/32 | 10-32 | 3/8 | Slot |
| NB-350-24 | 1 | 24 | 14-4 | 350kcmil-6 | 1-17/32 | 4-23/32 | 2-17/32 | 10-32 | 3/8 | Slot |
| NB-350-24-W/R16* | 2 | 24 | 14-4 | 350kcmil-6 | 2-17/32 | 4-23/32 | 2-17/32 | 10-32 | 3/8 | Slot |
| NB-350-30 | 1 | 30 | 14-4 | 350kcmil-6 | 1-17/32 | 4-3/32 | 2-17/32 | 10-32 | 3/8 | Slot |
| NB-350-30-W/R16* | 2 | 30 | 14-4 | 350kcmil-6 | 2-17/32 | 4-3/32 | 2-17/32 | 10-32 | 3/8 | Slot |
| NB-350-36 | 1 | 36 | 14-4 | 350kcmil-6 | 1-17/32 | 4-23/32 | 2-17/32 | 10-32 | 3/8 | Slot |
| NB-350-36-W/R16* | 2 | 36 | 14-4 | 350kcmil-6 | 2-17/32 | 4-23/32 | 2-17/32 | 10-32 | 3/8 | Slot |
| NB-350-42 | 1 | 42 | 14-4 | 350kcmil-6 | 1-17/32 | 5-11/32 | 2-17/32 | 10-32 | 3/8 | Slot |
| NB-350-42-W/R16* | 2 | 42 | 14-4 | 350kcmil-6 | 2-17/32 | 5-11/32 | 2-17/32 | 10-32 | 3/8 | Slot |

All wire sizes, unless noted otherwise, are American Wire Gauge (AWG)

* Part includes phenolic mounting block R-16

Tested to UL 486A/B, UL File E6207

Aluminum Neutral Bars

Dual Rated

Conductor Range: #4-#14



TYPE NBAS

Features

- Manufactured from high strength aluminum alloy
- Electro-tin plated
- Dual rated
- Assemblies available with 2-231 circuits
- UL Recognized for grounding and power, and CSA Certified

Benefits

- Provides maximum conductivity
- Low contact resistance
- Use with both copper and aluminum conductors
- Application versatility
- Ensures reliability

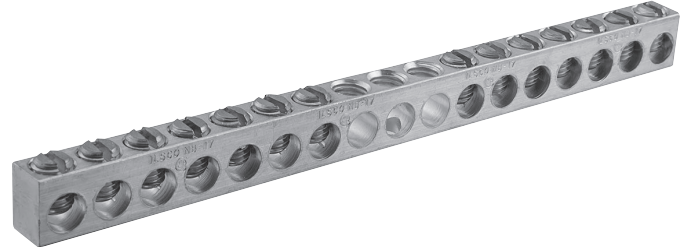
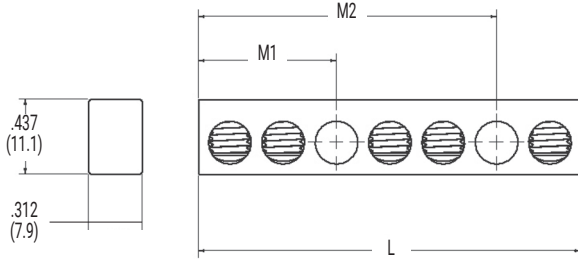

| Catalog Number | Number of Circuits | Mounting Hole Locations ¹ in. (mm) | | Screw Type | Configuration | Dimensions - in. (mm) | |
|----------------|--------------------|-----------------------------------------------|--------------|------------|---------------|-----------------------|----------|
| | | M1 | M2 | | | L | |
| NBAS-002-1-A | 2 | 0.492 (12.5) | - - | A | ●○● | 0.984 | (25.0) |
| NBAS-002-1-B | 2 | 0.492 (12.5) | - - | B | ●○● | 0.984 | (25.0) |
| NBAS-003-1-A | 3 | 0.804 (20.4) | - - | A | ●●○● | 1.296 | (32.9) |
| NBAS-003-1-B | 3 | 0.804 (20.4) | - - | B | ●●○● | 1.296 | (32.9) |
| NBAS-004-1-B | 4 | 0.804 (20.4) | - - | B | ●●○●● | 1.608 | (40.8) |
| NBAS-004-2-B | 4 | 0.180 (4.6) | 1.740 (44.2) | B | ○●●●●○ | 1.920 | (48.8) |
| NBAS-006-1-B | 6 | 1.116 (28.3) | - - | B | ●●●○●● | 2.232 | (56.7) |
| NBAS-008-2-A | 8 | 0.492 (12.5) | 2.676 (68.0) | A | ●○●●●●●○● | 3.168 | (80.5) |
| NBAS-009-2-A | 9 | 0.180 (4.6) | 3.300 (83.8) | A | ○●●●●●●●○△ | 3.792 | (96.3) |
| NBAS-010-1-B | 10 | 2.052 (52.1) | - - | B | ●●●●△△●●●● | 4.104 | (104.2) |
| NBAS-012-1-B | 12 | 2.364 (60.0) | - - | B | ●●●●△△●●●● | 4.728 | (120.1) |
| NBAS-012-2-A | 12 | 1.116 (28.3) | 3.300 (83.8) | A | ●●●○●●●●●○●● | 4.416 | (112.2) |
| NBAS-013-2-A | 13 | 1.116 (28.3) | 3.612 (91.7) | A | ●●●○●●●●●○●● | 4.728 | (120.1) |
| NBAS-014-1-B | 14 | 2.676 (60.0) | - - | B | ●●●●●△△●●●●● | 5.354 | (136.0) |
| NBAS-192-0-A* | 192 | - - | - - | A | ● x 192 | 60.000 | (1524.0) |
| NBAS-192-0-B | 192 | - - | - - | B | ● x 192 | 60.000 | (1524.0) |
| NBAS-231-0-A* | 231 | - - | - - | A | ● x 231 | 72.000 | (1828.8) |
| NBAS-231-0-B | 231 | - - | - - | B | ● x 231 | 72.000 | (1828.8) |

¹ Mounting holes have a diameter of 0.203 in. (5.2mm)

All wire sizes, unless noted otherwise, are American Wire Gauge (AWG)

* Screws are provided unassembled

Tested to UL 486A/B, UL File E6207 and CSA C22.2 No. 65-03

Tested to UL 467, UL File E6207

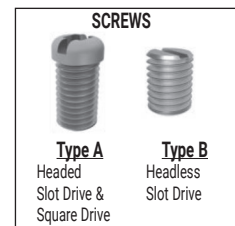
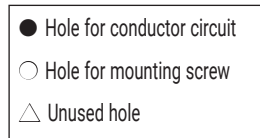

Aluminum Neutral Bars

Extended Conductors

Conductor Range: #6-#14 and 1/0-#14



TYPE NBAE

Features

- Manufactured from high strength aluminum alloy
- Electro-tin plated
- Dual rated
- Assemblies available with 6-123 circuits
- UL Recognized for grounding and power, and CSA Certified

Benefits

- Provides maximum conductivity
- Low contact resistance
- Use with both copper and aluminum conductors
- Application versatility
- Ensures reliability

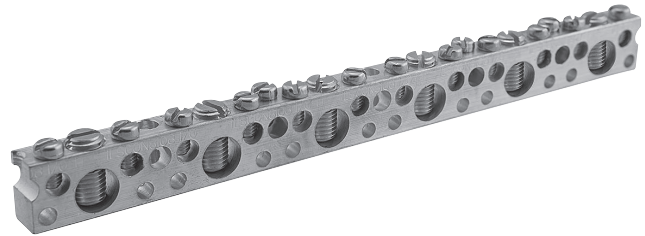
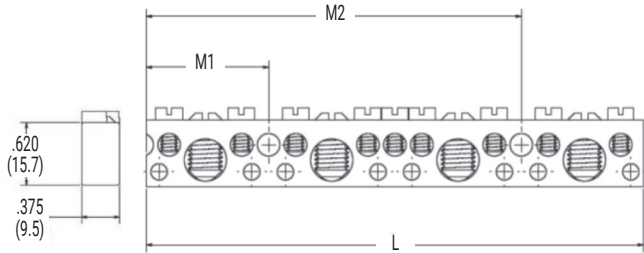

| Catalog Number | Number of Large Circuits ¹ | Number of Small Circuits ² | Mounting Hole Locations ³ in. (mm) | | | | Dimensions - in. (mm) | |
|----------------|---------------------------------------|---------------------------------------|-----------------------------------------------|---------|-------|---------|-----------------------|---------|
| | | | M1 | | M2 | | L | |
| NBAE-0204-1 | 2 | 4 | 1.133 | (28.8) | - | - | 2.265 | (57.5) |
| NBAE-0307-1 | 3 | 7 | 2.305 | (58.5) | - | - | 3.438 | (87.3) |
| NBAE-0409-2 | 4 | 9 | 1.133 | (28.8) | 3.477 | (88.3) | 4.609 | (117.1) |
| NBAE-0410-1 | 4 | 10 | 2.305 | (58.5) | - | - | 4.609 | (117.1) |
| NBAE-0512-2 | 5 | 12 | 2.305 | (58.5) | 4.648 | (118.1) | 5.781 | (146.8) |
| NBAE-0615-2 | 6 | 15 | 3.477 | (88.3) | 5.821 | (147.9) | 6.954 | (176.6) |
| NBAE-0924-2 | 9 | 24 | 2.305 | (58.5) | 9.336 | (237.1) | 10.468 | (265.9) |
| NBAE-1233-2 | 12 | 33 | 5.820 | (147.8) | 8.164 | (207.4) | 13.986 | (355.2) |
| NBAE-3192-0 | 31 | 92 | - | - | - | - | 36.250 | (920.8) |

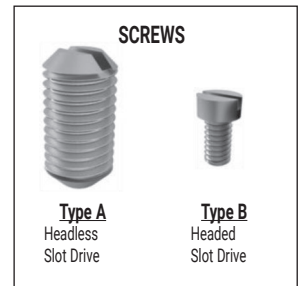

¹ Large Circuits have a conductor range of 1/0-14AWG
² Small Circuits have a conductor range of 6-14AWG
³ Mounting holes have a diameter of 0.203 in. (5.2mm)

| Catalog Number | Configuration |
|----------------|---------------------------------------------|
| NBAE-0204-1 | ★●★○★●★ |
| NBAE-0307-1 | ★●★●★●★○★●★ |
| NBAE-0409-2 | ★●★○★●★●★●★○★●★ |
| NBAE-0410-1 | ★●★●★●★○★●★●★●★ |
| NBAE-0512-2 | ★●★●★●★○★●★●★●★○★●★ |
| NBAE-0615-2 | ★●★●★●★●★○★●★●★●★○★●★ |
| NBAE-0924-2 | ★●★●★●★○★●★●★●★●★●★●★●★●★●★●★●★○★●★ |
| NBAE-1233-2 | ★●★●★●★●★●★●★●★●★●★○★●★●★●★●★●★●★●★●★●★●★●★ |
| NBAE-3192-0 | ★●★●★●★●★●★●★●★●★●★○★●★●★●★●★●★●★●★●★●★●★●★ |

All wire sizes, unless noted otherwise, are American Wire Gauge (AWG)
 Tested to UL 486A/B, UL File E6207 and CSA C22.2 No. 65-03
 Tested to UL 467, UL File E6207

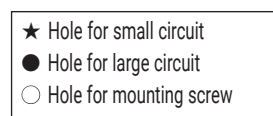

Neutral Bar Adapter

RoHS
Compliant



TYPE NBST

Features

- Connects a 2/0-14 conductor to a neutral bar
- Seamless stabs
- Conductor entry at 90° or parallel to neutral bar
- Mounts to solar nodes and neutral bars with hole spacing from .300 in to .350 in
- Hex socket screw included
- Manufactured from high strength aluminum
- Electro-tin plated
- UL 486 A/B and UL 467 Recognized, 90° C/194° F

Benefits

- Enables connection of a larger conductor for application versatility
- Provide dual current path for reliability and cool operation
- Multiple conductor orientation
- For diverse field applications
- Offers higher torque rating for reliability
- Suitable for use with copper or aluminum conductors
- Provides low contact resistance
- For power and grounding applications

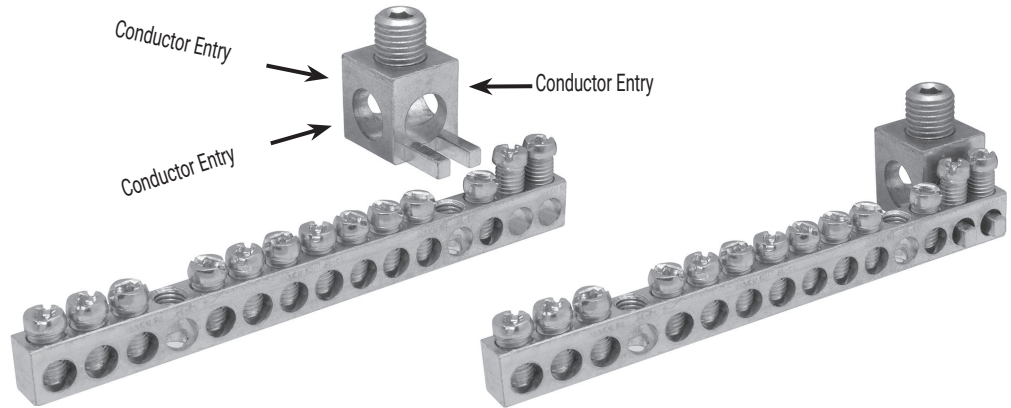
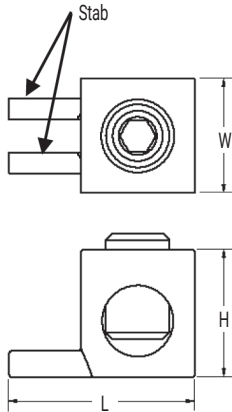

| Catalog Number | Wire Range | Dimensions - in. (mm) | | | Hex Size |
|----------------|------------|-----------------------|--------------|--------------|----------|
| | | H | W | L | |
| NBST-2/0 | 2/0-14 | 1.140 (29.0) | 0.700 (17.8) | 0.780 (19.8) | 3/16 |

| UL Recognized for use with nVent ILSCO | |
|----------------------------------------|-------------|
| Neutral Bars | Solar Nodes |
| NB-350 | SCNL |
| NBAS | SCNM |

All wire sizes, unless noted otherwise, are American Wire Gauge (AWG)
De-Ox oxide inhibitor is recommended for all aluminum terminations

Solar Combiner Node

Lay-In

RoHS
Compliant



TYPE SCNL

Features

- Manufactured from high strength aluminum alloy
- Configuration - 27 inputs and 1 output
- Conductor Input: 4-14
- Conductor Output: 750kcmil-1/0
- Designed for insulators up to 2000V
- For unfused PV source inputs up to 420A CU, 340A AL

Benefits

- Provide maximum conductivity and strength for copper and aluminum conductors
- Application versatility
- Input accepts Class B and C conductors
- Output accepts Class B and C conductors
- Mounting hardware fits variety of commercial insulators

C

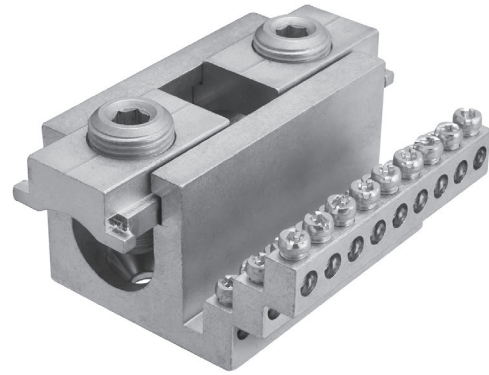
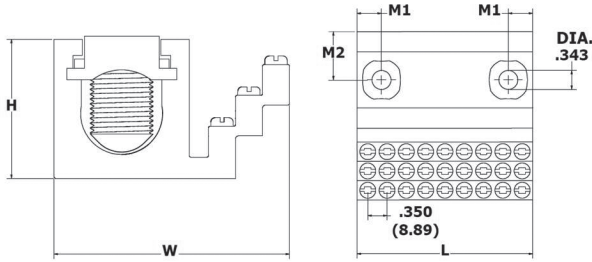

| Catalog Number | Primary | | | | Secondary | | | Dimensions - in. (mm) | | | | |
|----------------|----------------|----------------|--------------------|------------|--------------|--------------------|----------|-----------------------|--------------|--------------|--------------|--------------|
| | Wire Range | Wires per Hole | Number of Circuits | Screw Type | Wire Range | Number of Circuits | Hex Size | W | H | L | M1 | M2 |
| SCNL-27 | 4-14 10-14+ | 1 2 | 27 54 | Slot/SQ | 750kcmil-1/0 | 1 | 5/16 | 3.050 (77.5) | 1.800 (45.7) | 3.186 (80.9) | 0.443 (11.3) | 0.875 (22.2) |

All wire sizes, unless noted otherwise, are American Wire Gauge (AWG)

Two 5/16 dia, 5/16 depth flat-head screws are included for mounting. Insulators sold separately, consult factory for ordering information.

UL/cUL Recognized to UL486A/B, UL File E6207

+ See Information Sheet for other UL approved two wire combinations.

TYPE SCNM

Features

- Manufactured from high strength aluminum alloy
- Configuration - 18 to 42 string inputs; 4 outputs
- Conductor Input: 4-14
- Conductor Output: 1000kcmil-6
- Designed for insulators up to 2000V

Benefits

- Provides maximum conductivity and strength for copper and aluminum conductors
- Application versatility
- Input accepts Class B and C conductors
- Output accepts Class B, C, G, H, I, K, M and DLO conductors
- Mounting hardware fits variety of commercial insulators

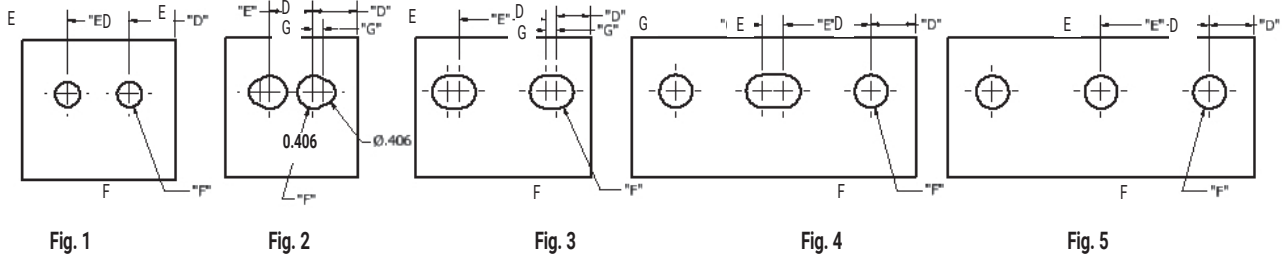

Lug Mount Configurations (See Figure Number above)

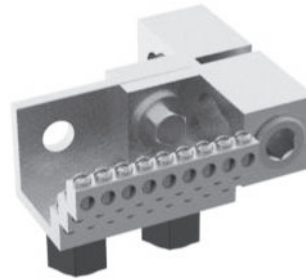
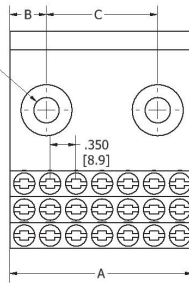
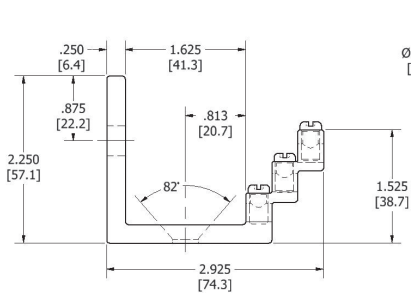

Typical Mechanical
Lug Mount

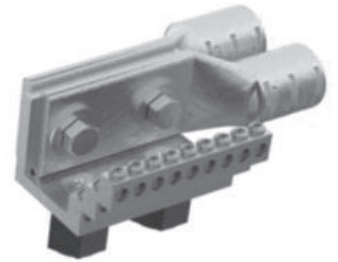

Typical Compression
Lug Mount

| Catalog Number | Lug Mount Fig. No. | PV Source Input** | String Input | | Output | | Dimensions - in. (mm) | | | | | | |
|----------------|--------------------|-------------------|----------------|------------|-----------------|-------------|-----------------------|---------------|---------------|---------------|---------------|---------------|---------------|
| | | | No. of Strings | Wire Range | No. of Circuits | Wire Range | A | B | C | D | E | F | G |
| SCNM-18 | 2 | 540 | 18 | 4-14 | 1-4 | 1000kcmil-6 | 2.136 (54.25) | 0.443 (11.25) | 1.250 (31.75) | 0.718 (18.24) | 0.700 (17.78) | 0.531 (13.49) | 0.150 (3.81) |
| SCNM-21 | 1 | 630 | 21 | 4-14 | 1-4 | 1000kcmil-6 | 2.468 (62.69) | 0.493 (12.52) | 1.500 (38.10) | 0.734 (18.64) | 1.000 (25.40) | 0.406 (10.31) | |
| SCNM-24 | 3 | 720 | 24 | 4-14 | 1-4* | 1000kcmil-6 | 2.836 (72.03) | 0.543 (13.79) | 1.750 (44.45) | 0.543 (13.79) | 1.400 (35.56) | 0.531 (13.49) | 0.175 (4.45) |
| SCNM-27 | 1 | 810 | 27 | 4-14 | 1-4* | 1000kcmil-6 | 3.186 (80.92) | 0.593 (15.06) | 2.000 (50.80) | 0.718 (18.24) | 1.750 (44.45) | 0.531 (13.49) | |
| SCNM-30 | 3 | 900 | 30 | 4-14 | 1-4* | 1000kcmil-6 | 3.536 (89.81) | 0.518 (13.16) | 2.500 (63.50) | 0.718 (18.24) | 1.750 (44.45) | 0.531 (13.49) | 0.175 (4.45) |
| SCNM-33 | 3 | 990 | 33 | 4-14 | 1-4* | 1000kcmil-6 | 3.886 (98.70) | 0.443 (11.25) | 3.000 (76.20) | 0.718 (18.24) | 1.750 (44.45) | 0.531 (13.49) | 0.350 (8.89) |
| SCNM-36 | 3 | 1080 | 36 | 4-14 | 1-4* | 1000kcmil-6 | 4.236 (107.59) | 0.618 (15.70) | 3.000 (76.20) | 0.718 (18.24) | 1.750 (44.45) | 0.531 (13.49) | 0.525 (13.34) |
| SCNM-39 | 4 | 1170 | 39 | 4-14 | 1-4* | 1000kcmil-6 | 4.586 (116.48) | 0.793 (20.14) | 3.000 (76.20) | 0.718 (18.24) | 1.400 (35.56) | 0.531 (13.49) | 0.350 (8.89) |
| SCNM-42 | 5 | 1260 | 42 | 4-14 | 1-4* | 1000kcmil-6 | 4.936 (125.37) | 0.968 (24.59) | 3.000 (76.20) | 0.718 (18.24) | 1.750 (44.45) | 0.531 (13.49) | |

All wire sizes, unless noted otherwise, are American Wire Gauge (AWG)

**For non-fused PV string inputs, 30A per string

Each input hole contains a 1/4 - 28 UNF; slotted/square drive screw

Two 5/16-18 UNC x 1/2 screws are included for mounting to insulators (insulators sold separately, consult Customer Care for information)

*For use with mechanical or compression components; sold separately. NEMA mounting hole configurations

UL/cUL Recognized to UL486A/B, UL File E6207

nVent ILSCO SafetySub

Watertight, Underground Connectors

RoHS
Compliant

UL
LISTED

CSA
LR-29601

TYPE USPASS

Features

- Encapsulated with dielectric strength polymer
- Manufactured from high strength aluminum alloy
- Compact design
- De-Ox oxide inhibiting compound optional
- Connector rated for 600 volts, 90° C/194° F
- Range taking
- Meets or exceeds UL 486D

Benefits

- Completely watertight in line splice. Ready for installation. (not a mold for use with mixed compounds) No taping required. No temperature or humidity restrictions.
- Suitable for use with copper or aluminum conductors
- Easily accessible in small hand holes
- Prevents oxides from forming
- Ensures reliability
- Reduces inventory
- UL Listed and CSA Certified for direct burial in earth or concrete

C

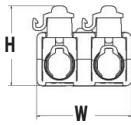
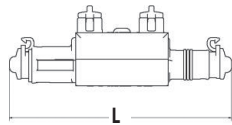

Fig. 1



Fig. 2



Fig. 3



Fig. 4

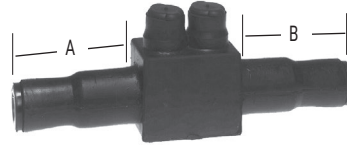

Fig. 5

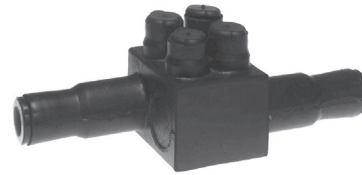

Fig. 6

| Catalog Number | Figure No. | Wire Range | Dimensions - in. (mm) | | |
|------------------|------------|----------------|-----------------------|--------------|---------------|
| | | | | M1 | M2 |
| USPA-1/0SS-DB* | 1 | 1/0-14 | 0.930 (23.6) | 1.925 (48.9) | 5.630 (143.0) |
| USPA21-1/0SS-DB* | 2 | 1/0-14 | 2.190 (55.6) | 1.925 (48.9) | 4.000 (101.6) |
| USPA22-1/0SS-DB* | 3 | 1/0-14 | 2.395 (60.8) | 2.000 (50.8) | 5.630 (143.0) |
| USPA-350SS-DB+ | 4 | 350kcmil-10str | 1.162 (29.5) | 2.500 (63.5) | 8.625 (219.0) |
| USPA-500SS-DB | 5 | 500kcmil-10 | 1.925 (48.8) | 3.219 (81.7) | 9.812 (249.2) |
| USPA-750SS-DB | 6 | 750kcmil-2 | 3.596 (91.3) | 3.843 (83.4) | 9.188 (233.4) |

All wire sizes, unless noted otherwise, are American Wire Gauge (AWG)

+ RUS Listed

Tested to UL 486D, UL File E125087

*For De-Ox, add "P" following the SS (e.g. USPA-1/0SSP-DB)

Watertight Underground Splice Kits

TYPE
SS
SSK
SSKC

Features

- Watertight EPDM rubber splice cover
- Tapered ends
- Ready for installation
- Type SS is cover only supplied with lubricant
- Type SSK kit is supplied with both connector and lubricant
- Connector rated for 600 volts, 90° C/194° F

Benefits

- No taping required. Suitable for direct burial
- Fits a wide range of conductor sizes
- Not a mold, can be used in any type of weather. (moisture and humidity are not a factor)
- Can be used with standard aluminum or copper compression from 500kcmil - 6. Lubricant permits easy insertion of conductors into sleeve.
- Supplied with dual-rated mechanical splice connector with a wire range of 350kcmil - 6
- Ensures reliability



Fig. 1



Fig. 2

C

| Catalog Number | Figure No. | Wire Range | | Dimensions (in.) |
|----------------|------------|------------------|---------------------|------------------|
| | | Bolted Connector | Compression Sleeves | L |
| SSK-350-Z | 1 | 350kcmil-6 | - | 5-1/2 |
| SS-350-Z | 2 | 350kcmil-6 | 500kcmil-6 | 5-1/2 |



| Catalog Number | Connector Catalog Number | Wire Size | Wire Range when Installed with IDT 12-Tool |
|----------------|--------------------------|-----------|--------------------------------------------|
| SSKC-6-Z | AS-6 | 6 | 6 |
| SSKC-4-Z | AS-4 | 4 | 4-6 |
| SSKC-2-Z | AS-2 | 2 | 2-6 |
| SSKC-1/0-Z | AS-1/0 | 1/0 | 1/0-1 |
| SSKC-2/0-Z | AS-2/0 | 2/0 | 2/0-1 |
| SSKC-3/0-Z | AS-3/0 | 3/0 | 3/0-1 |
| SSKC-4/0-Z | AS-4/0 | 4/0 | 4/0-1 |
| SSKC-250-Z | AS-250 | 250kcmil | 250kcmil-1/0 |

All wire sizes, unless noted otherwise, are American Wire Gauge (AWG)

Parallel Groove Clamps

Dual Rated

RoHS
Compliant

TYPE
PG

Features

- Manufactured from high strength 6061-T6 aluminum alloy
- Clear plated
- Range taking

Benefits

- Suitable for use with either copper or aluminum conductors
- Provides low contact resistance
- Permits inventories to be kept to a minimum

C

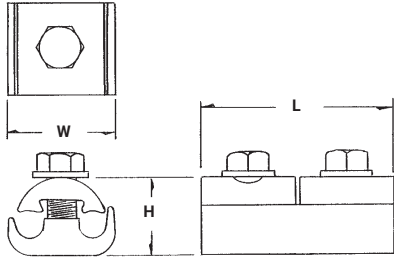

Fig. 1



Fig. 2



Fig. 3

| Catalog Number | Figure Number | Wire Range Both Grooves | Type and Bolt Size | Dimensions (in.) | | |
|----------------|---------------|-------------------------|--------------------|------------------|-------|--------|
| | | | | L | H | W |
| PG810-S-Z | 1 | 1/0-8 sol | 3/8, Steel | 1-1/8 | 1-5/8 | 1-3/16 |
| PG620-Z | 2 | 2/0-6 sol | 7/16, AL | 1-3/8 | 1-5/8 | 1-1/4 |
| PG620-S-Z | 2 | 2/0-6 sol | 3/8, Steel | 1-3/16 | 1-5/8 | 1-1/8 |
| PG620-2A-Z | 3 | 2/0-6 sol | 3/8, AL | 2-7/16 | 1-5/8 | 1-1/4 |
| PG620-2S-Z | 3 | 2/0-6 sol | 3/8, Steel | 2-7/16 | 1-5/8 | 1-1/4 |
| PG402-S-Z | 2 | 4/0-2 | 3/8, Steel | 1-1/2 | 1-3/4 | 1-3/8 |
| PG402-2S-Z | 3 | 4/0-2 | 3/8, Steel | 3-1/16 | 1-3/4 | 1-3/8 |

All wire sizes, unless noted otherwise, are American Wire Gauge (AWG)
De-Ox Inhibitor is recommended for all aluminum terminations.

Aluminum Grounding Connectors

Dual Rated

RoHS
Compliant

TYPE GRM GRF

Features

- Manufactured from high strength 6061-T6 aluminum alloy
- Electro-tin plated
- Type GRM - Elongated steel stud
- Type GRF - Threaded female design

Benefits

- Suitable for use with either copper or aluminum conductors
- Provides low contact resistance
- Provides ease of grounding a single conductor to steel structures or to tap a single conductor from bus bar
- Provides ease of installation for a variety of standard stud sizes

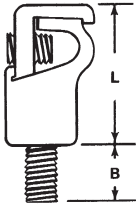

Fig. 1

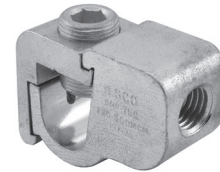
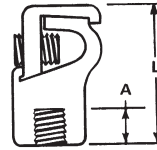

Fig. 2

C

| Catalog Number | Fig. No. | Wire Range | | | Dia. Thread | Dimensions (in.) | | | Hex Size |
|----------------|----------|------------|-----------|--------------|-------------|------------------|-----|---------|----------|
| | | Max. | Min. | Steel Strand | | A | B | L | |
| GRM-2B | 1 | 2str | 12sol/str | 5/16 | 5/16 in-18 | - | 3/8 | 1-1/4 | Slot |
| GRF-2A | 2 | 2str | 12sol/str | 5/16 | 1/4 in-20 | 5/16 | - | 1-1/4 | Slot |
| GRF-2B | 2 | 2str | 12sol/str | 5/16 | 5/16 in-18 | 3/8 | - | 1-1/4 | Slot |
| GRF-0 | 2 | 1/0str | 2str | 3/8 | 1/2 in-13 | 1/2 | - | 1-9/16 | Slot |
| GRF-250B | 2 | 250kcmil | 1/0 | 9/16 | 5/8 in-11 | 3/4 | - | 2-1/8 | 5/16 |
| GRF-350 | 2 | 350kcmil | 4/0 | - | 5/8 in-11 | 3/4 | - | 2-1/2 | 3/8 |
| GRF-500 | 2 | 500kcmil | 350kcmil | - | 3/4 in-10 | 7/8 | - | 2-15/16 | 3/8 |

All wire sizes, unless noted otherwise, are American Wire Gauge (AWG)
De-Ox Inhibitor is recommended for all aluminum terminations.

Copper Mechanical Lugs

One Conductor, One Hole

RoHS
Compliant

UL
LISTED
453G

SA
LR-29601

TYPE
SLU
SLS
SAS
SAU

Features

- Manufactured from electrolytic copper tubing and strip stock
- Compact design
- Range taking
- Re-usable
- Suitable for use in circuits rated 35KV or less, proper high voltage spacing and insulation techniques must be used
- V-bottom collar
- SLU-35DB and SLU-70DB are UL 467 Listed and suitable for direct burial
- Rated to 90° C/194° F

Benefits

- Provides maximum conductivity and strength
- Saves space and reduces installation time
- Permits inventories to be kept to a minimum
- Provides efficient use and flexibility in the field
- Application versatility
- Wires are wedged between arched pressure bar and collar establishing positive contact and firm permanent grip

C

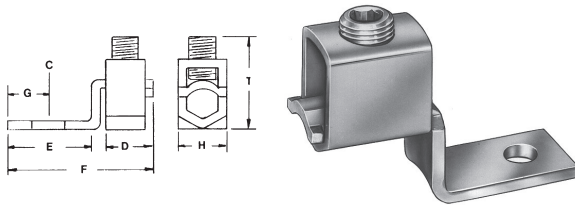

Fig. 1

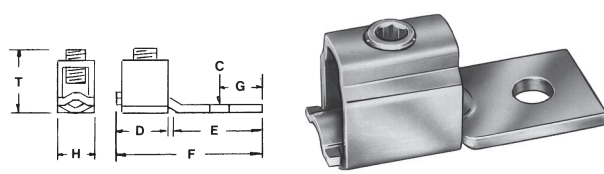

Fig. 2

| Catalog Number | Screw Type | Fig. No. | Wire Range Copper | Bolt Size | Dimensions (in.) | | | | | | | Hex Size |
|----------------|------------|----------|-----------------------|-----------|------------------|-------|---------|---------|--------|-------|---------|----------|
| | | | | | C | D | E | F | G | H | T | |
| SLU-35 | ⊖ | 1 | 6-14 & List Comb. (A) | #10 | 13/64 | 7/16 | 15/32 | 1-3/16 | 7/32 | 3/8 | 3/4 | Slot |
| SLU-35DB | ⊖ | 1 | 6-14 & List Comb. (A) | #10 | 13/64 | 7/16 | 15/32 | 1-3/16 | 7/32 | 3/8 | 3/4 | Slot |
| SAU-70 | ⊖ | 1 | 4-14 | 1/4 | 17/64 | 7/16 | 17/32 | 1-5/16 | 1/4 | 3/8 | 13/16 | Slot |
| SLU-70 | ⊖ | 1 | 2-8 & List Comb. (B) | 1/4 | 17/64 | 1/2 | 21/32 | 1-17/32 | 1/4 | 1/2 | 1 | Slot |
| SLU-70DB | ⊖ | 1 | 2-8 & List Comb. (B) | 1/4 | 17/64 | 1/2 | 21/32 | 1-17/32 | 1/4 | 1/2 | 1 | Slot |
| SLU-300 | ⊖ | 1 | 350kcmil-1/0 | 3/8 | 13/32 | 1-1/4 | 1-1/2 | 3-3/16 | 1/2 | 1 | 2-5/8 | 5/16 |
| SLU-400 | ⊖ | 1 | 500kcmil-1/0 | 3/8 | 13/32 | 1-1/2 | 1-15/16 | 4-14 | 15/16 | 1-1/2 | 2-3/4 | 5/16 |
| SLU-650 | ⊖ | 1 | 1000kcmil-600kcmil | 1/2 | 17/32 | 1-7/8 | 1-7/8 | 4-5/8 | 1-7/64 | 2 | 3-11/16 | 3/8 |
| SLS-35 | ⊖ | 2 | 6-14 & List Comb. (A) | #10 | 13/64 | 7/16 | 41/64 | 1-9/64 | 7/32 | 3/8 | 11/16 | Slot |
| SAS-70 | ⊖ | 2 | 4-14 | 1/4 | 17/64 | 7/16 | 23/32 | 1-1/4 | 1/4 | 1/2 | 27/32 | Slot |
| SLS-70 | ⊖ | 2 | 2-8 & List Comb. (B) | 1/4 | 17/64 | 1/2 | 13/16 | 1-15/32 | 1/4 | 1/2 | 31/32 | Slot |
| SLS-300 | ⊖ | 2 | 350kcmil-1/0 | 3/8 | 13/32 | 1-1/4 | 1-1/2 | 3-3/16 | 1/2 | 1 | 2-3/8 | 5/16 |
| SLS-400 | ⊖ | 2 | 500kcmil-1/0 | 3/8 | 13/32 | 1-1/2 | 2-3/16 | 3-7/8 | 15/16 | 1-1/2 | 2-9/16 | 5/16 |
| SLS-650 | ⊖ | 2 | 1000kcmil-600kcmil | 1/2 | 17/32 | 1-7/8 | 3 | 5-1/8 | 1-3/16 | 2 | 3-11/16 | 3/8 |

* Tin Plated

All wire sizes, unless noted otherwise, are American Wire Gauge (AWG)

(A) UL Listed wire combinations: (2) #10; (2) #12; (2) #14; (1) #12 and (1) #14; (1) #10 and (1) #12

(B) UL Listed wire combinations: (1) #8 and (1) #4; (1) #8 and (1) #6; (2) #4; (3) #8; (3) #6; (2) #8 and (1) #4; (2) #8 and (1) #6; (1) #6 and (1) #4; (2) #6

Tested to UL 486A/B, UL File E6207

Copper Mechanical Lugs

One Conductor, Two Hole

RoHS
Compliant

UL
LISTED
453G

SA
LR-29601

TYPE
E
H

Features

- Manufactured from electrolytic copper tubing and strip stock
- Compact design
- Range taking
- Re-usable
- Suitable for use in circuits rated 35KV or less, proper high voltage spacing and insulation techniques must be used
- V-bottom collar
- Two mounting holes
- Rated to 90° C/194° F

Benefits

- Provides maximum conductivity and strength
- Saves space and reduces installation time
- Permits inventories to be kept to a minimum
- Provides efficient use and flexibility in the field
- Application versatility
- Wires are wedged between arched pressure bar and collar establishing positive contact and firm permanent grip
- Acts as anti-rotation device and prevents turning in safety switches, control equipment etc.

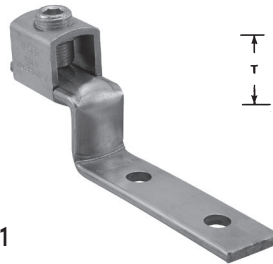
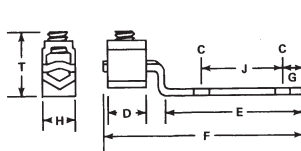

Fig. 1

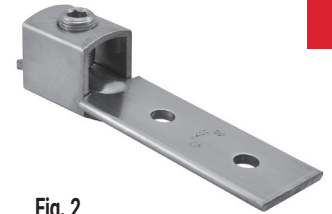
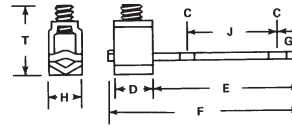

Fig. 2

C

| Catalog Number | Fig. No. | Wire Range Copper | Bolt Size | Dimensions (in.) | | | | | | | | Hex Size |
|----------------|----------|-----------------------|-----------|------------------|-------|---------|---------|--------|-------|-------|---------|----------|
| | | | | C | D | E | F | G | H | J | T | |
| E-35 | 1 | 6-14 & List Comb. (A) | #10 | 13/64 | 7/16 | 1-1/2 | 2-1/4 | 7/32 | 3/8 | 1 | 3/4 | Slot |
| E-70 | 1 | 2-8 & List Comb. (B) | 1/4 | 17/64 | 1/2 | 1-1/2 | 2-7/16 | 1/4 | 1/2 | 1 | 1 | Slot |
| E-125 | 1 | 1/0-6 | 1/4 | 17/64 | 5/8 | 1-7/8 | 2-15/16 | 7/16 | 5/8 | 1 | 1-11/32 | Slot |
| E-225 | 1 | 4/0-2 | 5/16 | 11/32 | 1 | 2-5/32 | 3-19/32 | 1/2 | 1 | 1 | 1-13/16 | 7/32 |
| E-300 | 1 | 350kcmil-1/0 | 3/8 | 13/32 | 1-1/4 | 3-11/16 | 5-11/16 | 13/16 | 1 | 1-7/8 | 2-5/8 | 5/16 |
| E-400 | 1 | 500kcmil-1/0 | 3/8 | 13/32 | 1-1/2 | 3-13/16 | 6 | 15/16 | 1-1/2 | 1-3/4 | 2-3/4 | 5/16 |
| E-650 | 1 | 1000kcmil-600kcmil | 1/2 | 17/32 | 1-7/8 | 3-9/16 | 6-1/4 | 1-3/16 | 2 | 1-3/4 | 3-11/16 | 3/8 |
| H-70 | 2 | 2-8 & List Comb. (B) | 1/4 | 17/64 | 1/2 | 1-7/8 | 2-1/2 | 1/4 | 1/2 | 1 | 31/32 | Slot |
| H-400 | 2 | 500kcmil-1/0 | 3/8 | 13/32 | 1-1/2 | 3-15/16 | 5-5/8 | 15/16 | 1-1/2 | 1-3/4 | 2-9/16 | 5/16 |
| H-650 | 2 | 1000kcmil-600kcmil | 1/2 | 17/32 | 1-7/8 | 4-3/4 | 6-7/8 | 1-3/16 | 2 | 1-3/4 | 3-11/16 | 3/8 |

All wire sizes, unless noted otherwise, are American Wire Gauge (AWG)

(A) UL Listed wire combinations: (2) #10; (2) #12; (2) #14; (1) #12 and (1) #14; (1) #10 and (1) #12

(B) UL Listed wire combinations: (1) #8 and (1) #4; (1) #8 and (1) #6; (2) #4; (3) #8; (3) #6; (2) #8 and (1) #4; (2) #8 and (1) #6; (1) #6 and (1) #4; (2) #6

Tested to UL 486A/B, UL File E6207

Copper, Heavy Duty, Mechanical Lugs

One Conductor, One Hole



TYPE SLUH

Features

- Manufactured from electrolytic copper tubing and strip stock
- Compact design
- Range taking
- Re-usable
- Electro-tin plated
- Captive tang
- V-bottom collar
- Suitable for use in circuits rated 35KV or less, proper high voltage spacing and insulation techniques must be used
- Rated to 90° C/194° F

Benefits

- Provides maximum conductivity and strength
- Saves space and reduces installation time
- Permits inventories to be kept to a minimum
- Provides efficient use and flexibility in the field
- Provides low contact resistance
- Suited for heavy duty applications requiring high torque to withstand vibration and high ambient heat
- Wires are wedged between arched pressure bar and collar establishing positive contact and firm permanent grip
- Application versatility

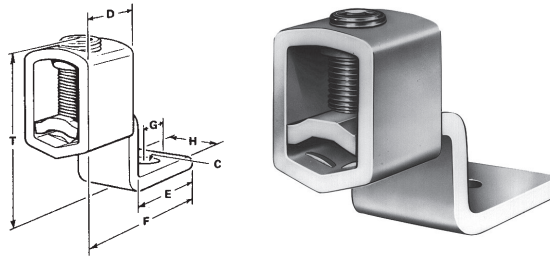

C

| Catalog Number | Wire Range | Bolt Size | Dimensions (in.) | | | | | | | Hex Size |
|----------------|---------------|-----------|------------------|---------|---------|---------|--------|-------|---------|----------|
| | | | C | D | E | F | G | H | T | |
| SLUH-35 | 6-14 | #10 | 13/64 | 7/16 | 1/2 | 1-1/8 | 7/32 | 3/8 | 11/16 | Slot |
| SLUH-90 | 2-14 | 1/4 | 17/64 | 9/16 | 5/8 | 1-31/64 | 1/4 | 1/2 | 27/32 | Slot |
| SLUH-125 | 1/0-8 | 1/4 | 17/64 | 11/16 | 13/16 | 1-7/8 | 7/16 | 5/8 | 63/64 | Slot |
| SLUH-225 | 250kcmil-6 | 5/16 | 11/32 | 1 | 1-5/32 | 2-7/16 | 1/2 | 1 | 1-17/64 | 1/4 |
| SLUH-300 | 350kcmil-1/0 | 3/8 | 13/32 | 1-3/16 | 1-1/2 | 3-1/16 | 1/2 | 1 | 2-1/4 | 5/16 |
| SLUH-400 | 500kcmil-1/0 | 3/8 | 13/32 | 1-3/8 | 1-15/16 | 3-13/16 | 15/16 | 1-1/2 | 2-15/32 | 5/16 |
| SLUH-650 | 1000kcmil-4/0 | 1/2 | 17/32 | 1-57/64 | 1-7/8 | 4-5/16 | 1-3/16 | 2 | 3-3/32 | 3/8 |

All wire sizes, unless noted otherwise, are American Wire Gauge (AWG) Tested to UL 486A/B, UL File E6207

| Conductor Class - Fine Stranded | | | | | | | |
|---------------------------------|--------------|--------------|--------------|---------------|---------------|----------------|------------------|
| B | C | G | H | I | K | M | Locomotive Cable |
| - | - | 14/49 | - | - | 14/41 | 14/104 | 14/19 |
| 14/7 | 14/19 | 12/49 | - | - | 12/65 | 12/168 | 12/19 |
| 12/7 | 12/19 | - | - | - | - | - | - |
| 10/7 | 10/19 | 10/49 | - | 10/26 | 10/104 | 10/259 | 10/27 |
| - | - | 8/49 | 8/133 | 8/41 | 8/168 | 8/420 | 8/37 |
| 8/7 | 8/19 | - | - | - | - | - | - |
| 6/7 | 6/19 | - | - | - | - | - | - |
| 4/7 | 4/19 | 6/49 | 6/133 | 6/63 | 6/266 | 6/665 | 6/61 |
| 3/7 | 3/19 | 4/49 | 4/133 | 4/105 | 4/420 | 4/1064 | 4/105 |
| 2/7 | 2/19 | 3/49 | 3/133 | 3/133 | 3/532 | 3/1323 | 3/125 |
| 1/19 | 1/37 | 2/49 | 2/133 | 2/161 | 2/665 | 2/1666 | 2/150 |
| 1/0/19 | 1/0-37 | 1/133 | 1/259 | 1/210 | 1/836 | 1/2107 | 1/225 |
| 2/0-19 | 2/0-37 | 1/0-133 | 1/0-259 | - | - | 1/0/2646 | 1/0/275 |
| 3/0-19 | 3/0-37 | 2/0-133 | 2/0-259 | 1/0/266 | 1/0/1064 | - | 2/0/325 |
| /0-19 | 4/0-37 | 3/0-133 | 3/0-259 | 2/0/342 | 2/0/1323 | 2/0/3325 | - |
| 250kcmil/37 | 250kcmil/61 | - | - | 3/0/418 | 3/0/1666 | 3/0/4256 | 3/0/450 |
| 300kcmil/37 | 300kcmil/61 | 4/0-133 | 4/0-259 | 4/0/532 | - | - | 222.2kcmil/550 |
| 350kcmil/37 | 350kcmil/61 | 250kcmil/259 | 250kcmil/427 | 250kcmil/637 | 4/0/2107 | 4/0/5320 | 262.6kcmil/650 |
| 400kcmil/37 | 400kcmil/61 | 300kcmil/259 | 300kcmil/427 | 300kcmil/735 | 250kcmil/2499 | 250kcmil/6384 | 313.1kcmil/775 |
| 500kcmil/37 | 500kcmil/61 | 350kcmil/259 | 350kcmil/427 | 350kcmil/882 | 300kcmil/2989 | 300kcmil/7581 | - |
| - | - | 400kcmil/259 | 400kcmil/427 | 400kcmil/980 | 350kcmil/3458 | 350kcmil/8806 | 373.7kcmil/925 |
| 600kcmil/61 | 600kcmil/91 | - | - | - | - | - | 444kcmil/1100 |
| 700kcmil/61 | 700kcmil/91 | 500kcmil/259 | 500kcmil/427 | 500kcmil/1225 | 450kcmil/4522 | 450kcmil/11396 | 535.3kcmil/1325 |
| 750kcmil/61 | 750kcmil/91 | 550kcmil/259 | 500kcmil/703 | 550kcmil/1372 | 500kcmil/5054 | 500kcmil/12691 | - |
| - | - | 600kcmil/259 | 500kcmil/703 | 600kcmil/1470 | 550kcmil/5453 | 550kcmil/13664 | 646.4kcmil/1591 |
| 1000kcmil/61 | 1000kcmil/91 | 750kcmil/259 | 500kcmil/703 | 650kcmil/1596 | 600kcmil/5985 | 600kcmil/14945 | - |

Copper Mechanical Lugs

One Conductor, One Hole

RoHS
Compliant

UL
LISTED
453G

SA
LR-29601

TYPE LO

Features

- Manufactured from electrolytic seamless copper tubing
- Compact design
- Range taking
- Re-usable
- Suitable for use in circuits rated 35KV or less, proper high voltage spacing and insulation techniques must be used
- Rated to 90° C/194° F

Benefits

- Provides maximum conductivity and strength
- Saves space and reduces installation time
- Permits inventories to be kept to a minimum
- Provides efficient use and flexibility in the field
- Application versatility

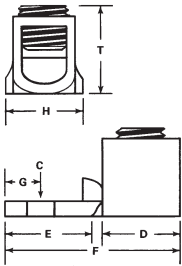

Fig. 1



Fig. 2



Fig. 3

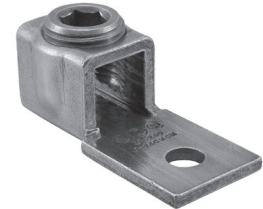

Fig. 4

C

| Catalog Number | Fig. No. | Bolt Size | Wire Range | Dimensions (in.) | | | | | | | Hex Size |
|----------------|----------|-----------|--------------------|------------------|---------|---------|---------|-------|-------|--------|----------|
| | | | | C | D | E | F | G | H | T | |
| LO-4 | 1 | 1/4 | 4-14 | 17/64 | 3/4 | 5/8 | 1-3/8 | 9/32 | 1/2 | 25/32 | Slot |
| LO-0 | 2 | 1/4 | 1/0-14 | 9/32 | 11/16 | 27/32 | 1-3/4 | 13/32 | 3/4 | 11/16 | Slot |
| LO-250 | 4 | 5/16 | 250kcmil-6 | 21/64 | 1 | 1-1/4 | 2-9/32 | 7/16 | 63/64 | 7/8 | 3/8 |
| LO-350SH | 3 | 1/2 | 350kcmil-4 | 17/32 | 7/8 | 1 | 2-7/32 | 1/2 | 1-1/8 | 1-3/16 | 3/8 |
| LO-350STD | 3 | 3/8 | 350kcmil-4 | 13/32 | 1-1/4 | 1-1/8 | 2-5/8 | 1/2 | 1-1/8 | 1-1/16 | 3/8 |
| LO-500 | 4 | 3/8 | 500kcmil-4/0 | 25/64 | 1-1/4 | 1-9/16 | 3-5/16 | 7/8 | 1-1/2 | 1-1/2 | 3/8 |
| LO-600 | 4 | 3/8 | 600kcmil-1 | 13/32 | 1-7/16 | 1-11/16 | 3-5/8 | 7/8 | 1-1/2 | 1-1/2 | 3/8 |
| LO-1000 | 4 | 1/2 | 1000kcmil-500kcmil | 17/32 | 1-17/32 | 1-7/8 | 3-15/16 | 27/32 | 2 | 2-1/16 | 3/8 |

All wire sizes, unless noted otherwise, are American Wire Gauge (AWG)
Tested to UL 486A/B, UL File E6207

Copper Mechanical Lugs

One Conductor, Two Hole

RoHS
Compliant

UL
LISTED
453G

SA
LR-29601

TYPE
VT
LO-S

Features

- Manufactured from electrolytic seamless copper tubing
- Compact design
- Range taking
- Re-usable
- Suitable for use in circuits rated 35KV or less, proper high voltage spacing and insulation techniques must be used
- Rated to 90° C/194° F

Benefits

- Provides maximum conductivity and strength
- Saves space and reduces installation time
- Permits inventories to be kept to a minimum
- Provides efficient use and flexibility in the field
- Application versatility

C

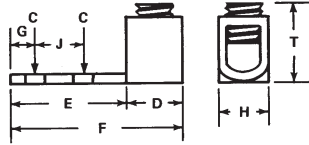

| Catalog Number | Wire Range | Bolt Size | Dimensions (in.) | | | | | | | | Hex Size |
|----------------|--------------------|-----------|------------------|--------|--------|--------|-----|-------|--------|--------|----------|
| | | | C | D | E | F | G | H | J | T | |
| VT-4-S | 4-14 | #10 | 15/64 | 9/16 | 1 | 1-3/4 | 1/4 | 1/2 | 1/2 | 25/32 | Slot |
| LO-0-S | 1/0-14 | 1/4 | 9/32 | 11/16 | 1-9/16 | 2-1/2 | 3/8 | 3/4 | 7/8 | 19/32 | Slot |
| LO-250-S | 250kcmil-6 | 3/8 | 13/32 | 1 | 1-3/4 | 3-3/32 | 3/8 | 1 | 1 | 7/8 | 3/8 |
| LO-350-S | 350kcmil-4 | 3/8 | 7/16 | 7/8 | 2 | 3-1/2 | 3/8 | 1-1/8 | 1-1/16 | 1-1/4 | 3/8 |
| LO-600-S | 600kcmil-1 | 1/2 | 9/16 | 1-7/16 | 2 | 3-7/8 | 3/8 | 1-1/4 | 1-1/16 | 1-1/2 | 3/8 |
| LO-1000-S | 1000kcmil-500kcmil | 1/2 | 9/16 | 1-9/16 | 2-1/2 | 4-1/2 | 3/8 | 1-5/8 | 1-3/16 | 2-1/16 | 3/8 |

All wire sizes, unless noted otherwise, are American Wire Gauge (AWG)
Tested to UL 486A/B, UL File E6207

Copper Mechanical Lugs

One Conductor, One Hole

RoHS
Compliant



TYPE XT LY

Features

- Manufactured from electrolytic copper tubing and strip stock
- Compact design
- Range taking
- Re-usable
- Suitable for use in circuits rated 35KV or less, proper high voltage spacing and insulation techniques must be used
- XT-6DB and XT-4DB are UL 467 Listed and suitable for direct burial, XT-4 certified to #8 solid copper wire
- Rated to 90° C/194° F

Benefits

- Provides maximum conductivity and strength
- Saves space and reduces installation time
- Permits inventories to be kept to a minimum
- Provides efficient use and flexibility in the field
- Application versatility

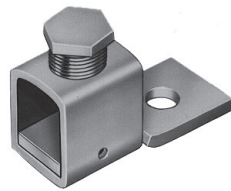
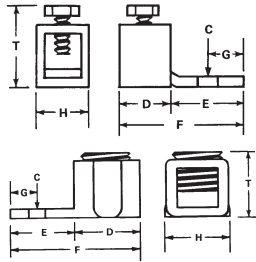

Fig. 1

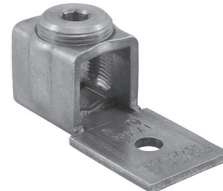

Fig. 2



Fig. 3



Fig. 4

C

| Catalog Number | Fig. No. | Wire Range | Bolt Size | Dimensions (in.) | | | | | | | Hex Size |
|----------------|----------|------------------------|-----------|------------------|--------|---------|---------|------|-------|--------|----------|
| | | | | C | D | E | F | G | H | T | |
| XT-10 | 3 | 10-14 | #6 | 5/32 | 9/32 | 17/32 | 7/8 | 3/16 | 5/16 | 17/32 | Slot |
| XT-6 ‡ | 4 | 6-18 | #10 | 13/64 | 3/8 | 17/32 | 1 | 7/32 | 3/8 | 3/4 | Slot |
| XT-6DB | 3 | 6-14 | #10 | 13/64 | 3/8 | 17/32 | 1 | 7/32 | 3/8 | 3/4 | Slot |
| XT-4 | 3 | 4-14 & List Comb. (A) | 1/4 | 17/64 | 1/2 | 5/8 | 1-1/8 | 1/4 | 1/2 | 5/8 | Slot |
| XT-4DB | 3 | 4-14 & List Comb. (A) | 1/4 | 17/64 | 1/2 | 5/8 | 1-1/8 | 1/4 | 1/2 | 5/8 | Slot |
| XT-0 | 3 | 1/0-6 & List Comb. (B) | 1/4 | 17/64 | 5/8 | 29/32 | 1-17/32 | 7/16 | 5/8 | 1 | Slot |
| XT-40 | 1 | 4/0-6 | 5/16 | 11/32 | 1 | 1-1/16 | 2-3/16 | 9/16 | .81 | 1-5/8 | EH 5/8 |
| XT-500*+ | 1 | 500kcmil-2/0 | 3/8 | 7/16 | 1-3/8 | 1-11/16 | 3-3/16 | 7/8 | 1-1/2 | 2-9/16 | EH 3/4 |
| LY-250-S+ | 2 | 250kcmil-6 | 1/4 | 17/64 | 1 | 13/16 | 1-13/16 | 3/8 | 1 | 1 | 3/8 |
| LY-600 | 2 | 600kcmil-1/0 (C) | 3/8 | 13/32 | 1-7/16 | 1-7/8 | 3-5/16 | 7/8 | 1-1/2 | 1-3/8 | 3/8 |
| LY-600-S | 2 | 600kcmil-1/0 (C) | 5/16 | 21/64 | 1-7/16 | 1-1/8 | 2-9/16 | 1/2 | 1-3/8 | 1-3/8 | 3/8 |

All wire sizes, unless noted otherwise, are American Wire Gauge (AWG)

*Furnished with Pressure Plate

+ EH External Hex

‡ UL 467 Listed for grounding and bonding. Not rated for direct burial.

(A) UL Listed wire combinations: (2) #14; (2) #12; (2) #10; (2) #8 and (4) #16

(B) UL Listed wire combinations: (2) #6 and (2) #8

(C) UL Listed wire combinations: (2) #4/0; (2) #3/0; (2) #2/0, and (2) #1/0

Tested to UL 486A/B, UL File E6207

Copper Post Connectors

RoHS
Compliant

UL
LISTED
453G

SA
LR-29601

TYPE CP

Features

- Manufactured from high conductivity copper alloy
- Compact design
- Range taking
- Re-usable
- Suitable for use in circuits rated 35KV or less, proper high voltage spacing and insulation techniques must be used
- Certified for grounding, bonding, and direct burial
- Rated to 90° C/194° F

Benefits

- Provides long lasting reliable contact
- Saves space and reduces installation time
- Permits inventories to be kept to a minimum
- Provides efficient use and flexibility in the field
- Application versatility
- Ensures a safe and reliable grounding connection

C

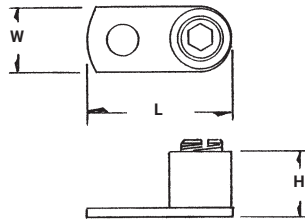

| Catalog Number | Wire Range | Bolt Size | Stud Hole | Dimensions (in.) | | | Hex Size |
|----------------|-------------------------|-------------|-----------|------------------|--------|--------|----------|
| | | | | C | D | T | |
| CP-8 | 8-14 Sol/Str | 10 | 13/64 | 0.8180 | 0.3950 | 0.4500 | Slot |
| CP-4 | 4-18 Str, 6-18 Sol | 1/4 | 17/64 | 1.0920 | 0.5400 | 0.5900 | Slot |
| CP-0 | 1/0-10 Str, 2-10 Sol | 5/16 or 1/4 | 11/32 | 1.5000 | 0.7300 | 0.7630 | 1/4 |
| CP-250 | 250kcmil-6 Str, 2-6 Sol | 3/8 or 5/16 | 13/32 | 1.9688 | 0.9375 | 1.0625 | 1/4 |
| CP-500*+ | 500kcmil-2/0 | 1/2 | 17/32 | 3.0000 | 1.4060 | 1.4690 | 3/8 |
| CP-1000*+ | 1000kcmil-500kcmil | 1/2 | 17/32 | 3.9688 | 2.0000 | 2.1560 | 1/2 |

All wire sizes, unless noted otherwise, are American Wire Gauge (AWG)

Tested to UL 486A/B and UL 467 for grounding and bonding, UL File E6207; suitable for direct burial

+ Tested only to UL 486A/B, UL File E6207

* Not CSA Certified

Copper, Box Type Mechanical Lugs

RoHS
Compliant



TYPE CO

Features

- Manufactured from electrolytic seamless copper tubing
- Compact design
- Range taking
- Re-usable
- Suitable for use in circuits rated 35KV or less, proper high voltage spacing and insulation techniques must be used
- Bossed mounting holes
- Rated for 90° C/194° F

Benefits

- Provides maximum conductivity and strength
- Saves space and reduces installation time
- Permits inventories to be kept to a minimum
- Provides efficient use and flexibility in the field
- Application versatility
- Acts as an anti-rotation device and prevents the connector from turning



Fig. 1



Fig. 2



Fig. 3

C

| Catalog Number | Fig. No. | Wire Range | Dimensions (in.) | | | | | | | |
|----------------|----------|------------|------------------|-------|-----------------------|-----------------------------|-----------------------------------|-----------------|--------------------------------------|-----------------------|
| | | | L | W | Height with Max. Wire | Bossed Mounting Hole Tapped | Style Boss and Outside Dimensions | Top Hole Tapped | Top Hole and Inner Side Walls Tapped | Bottom Clearance Hole |
| CO3RP | 1 | 6-14 | 3/8 | 11/32 | 21/32 | 8-32 | Round .216-.220 | 1/4-28 | - | - |
| CO3SP | 1 | 6-14 | 3/8 | 11/32 | 21/32 | 10-32 | Square .216-.220 | 1/4-28 | - | - |
| CO4SP | 2 | 4-14 | 15/32 | 29/64 | 19/32 | 10-32 | Square .227-.231 | 5/16-24 | - | - |
| CO4CW | 3 | 4-14 | 15/32 | 29/64 | 3/4 | - | - | - | 3/8-27 | .203 |

All wire sizes, unless noted otherwise, are American Wire Gauge (AWG)
Tested to UL 486A/B, UL File E6207

Copper, Box Type Mechanical Lugs

RoHS
Compliant



TYPE CO

Features

- Manufactured from electrolytic seamless copper tubing
- Compact design
- Range taking
- Re-usable
- Suitable for use in circuits rated 35KV or less, proper high voltage spacing and insulation techniques must be used
- Bossed mounting holes
- Rated for 90° C/194° F

Benefits

- Provides maximum conductivity and strength
- Saves space and reduces installation time
- Permits inventories to be kept to a minimum
- Provides efficient use and flexibility in the field
- Application versatility
- Acts as an anti-rotation device and prevents the connector from turning

C



Fig. 1



Fig. 2



Fig. 3

| Catalog Number | Fig. No. | Wire Range | Dimensions (in.) | | | | | | | |
|----------------|----------|--------------|------------------|-------|-----------------------|-----------------------------|-----------------------------------|-----------------|--------------------------------------|-----------------------|
| | | | L | W | Height with Max. Wire | Bossed Mounting Hole Tapped | Style Boss and Outside Dimensions | Top Hole Tapped | Top Hole and Inner Side Walls Tapped | Bottom Clearance Hole |
| C05SP | 1 | 1/0-6 | 5/8 | 9/16 | 29/32 | 10-32 | Square .227-.231 | 3/8-27 | - | - |
| C06RP | 2 | 4/0-2 | 1 | 13/16 | 1-9/16 | 1/4-20 | Round .2825-.2875 | 9/16-24 | - | - |
| C07 | 3 | 500kcmil-1/0 | 1-3/8 | 1-1/8 | 2-3/8 | 1/4-20 | Round .3025-.3225 | 5/8-18 | - | - |

All wire sizes, unless noted otherwise, are American Wire Gauge (AWG)
Tested to UL 486A/B, UL File E6207

Copper Service Entrance Mechanical Lugs

TYPE SX

Features

- Manufactured from high strength copper tubing
- Compact design
- Versatile

Benefits

- Provides maximum conductivity for copper conductors
- Requires very little space
- Can be installed with either screwdriver, wrench, or pliers

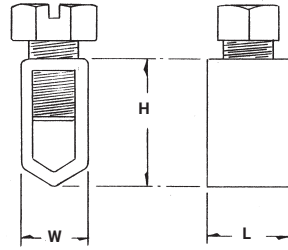

C

| Catalog Number | Wire Range | Dimensions (in.) | | |
|----------------|------------|------------------|-------|-------|
| | | L | W | H |
| SX-12 | 12str | 9/32 | 1/4 | 3/8 |
| SX-10-8 | 8-10str | 5/16 | 1/4 | 31/64 |
| SX-6+ | 6str | 7/16 | 11/32 | 11/16 |

All wire sizes, unless noted otherwise, are American Wire Gauge (AWG)
+ RUS Listed

Copper Splicer/Reducer

RoHS
Compliant



TYPE 2SC

Features

- Manufactured from electrolytic seamless copper tubing
- Compact design
- Range taking
- Re-usable
- V-bottom collar with serrations
- Two screw design
- Suitable for use in circuits rated 35KV or less, proper high voltage spacing and insulation techniques must be used
- Rated for 90° C/194° F

Benefits

- Provides maximum conductivity and strength
- Saves space and reduces installation time
- Permits inventories to be kept to a minimum
- Provides efficient use and flexibility in the field
- Wires are held securely between set screws and v-bottom providing superior pullout strength
- For light duty applications
- Application versatility

C

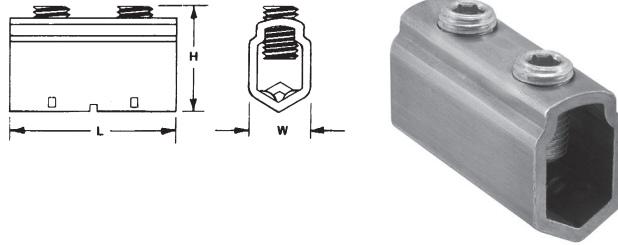

| Catalog Number | Wire Range | Dimensions (in.) | | | Screw | Hex Size |
|----------------|------------|------------------|-----|-----|------------------|----------|
| | | L | W | H | | |
| 2SC-50 | 4-14 | 7/8 | 3/8 | 3/4 | Slotted Headless | Slot |

All wire sizes, unless noted otherwise, are American Wire Gauge (AWG)
Tested to UL 486A/B, UL File E6207

Copper Mechanical Lugs

Two Conductor, One Hole

RoHS
Compliant



TYPE MU LU

Features

- Manufactured from electrolytic copper tubing and strip stock
- Compact design
- Range taking
- Re-usable
- V-bottom collar (Type LU)
- Suitable for use in circuits rated 35KV or less, proper high voltage spacing and insulation techniques must be used
- Rated for 90° C/194° F

Benefits

- Provides maximum conductivity and strength
- Saves space and reduces installation time
- Permits inventories to be kept to a minimum
- Provides efficient use and flexibility in the field
- Wires are wedged between arched pressure bar and collar establishing positive contact and firm permanent grip
- Application versatility

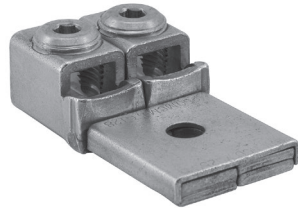
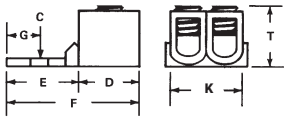

Fig. 1

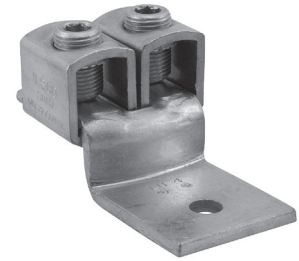
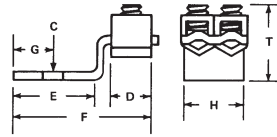

Fig. 2

C

| Catalog Number | Fig. No. | Wire Range | Bolt Size | Collar Style | Dimensions (in.) | | | | | | | | Hex Size |
|----------------|----------|-------------------|-----------|--------------|------------------|--------|---------|---------|-------|-------|-------|--------|----------|
| | | | | | L | W | L | W | L | W | L | W | |
| MU-250 | 1 | Two: 250kcmil-6 | 3/8 | Square | 25/64 | 1 | 1-9/16 | 2-15/16 | 7/8 | 1-1/2 | 1-5/8 | 15/16 | 1/4 |
| MU-350 | 1 | Two: 350kcmil-1/0 | 1/2 | Round | 9/16 | 1-9/16 | 1-13/16 | 3-5/16 | 7/8 | 1-3/4 | 1-7/8 | 1-9/16 | 3/8 |
| MU-600 | 1 | Two: 600kcmil-4/0 | 1/2 | Round | 9/16 | 1-1/4 | 1-13/16 | 3-5/8 | 7/8 | 2-1/4 | 2-1/2 | 1-3/4 | 3/8 |
| LU-4 | 2 | Two: 350kcmil-1/0 | 3/8 | V-bottom | 13/32 | 1-1/4 | 1-3/4 | 3-1/2 | 21/32 | 1-3/4 | 2 | 2-7/32 | 5/16 |
| LU-6 | 2 | Two: 500kcmil-1/0 | 1/2 | V-bottom | 17/32 | 1-1/2 | 2-3/16 | 4-7/16 | 27/32 | 2 | 2-1/4 | 2-9/16 | 5/16 |

All wire sizes, unless noted otherwise, are American Wire Gauge (AWG)
Tested to UL 486A/B, UL File E6207

Bronze, One Conductor Mechanical Lugs One Mounting Hole

RoHS
Compliant

UL
LISTED
8M24

SA
1P-1009T3-1

TYPE
CL

Features

- Range taking
- Easily installed with a key wrench
- Convenient peep hole
- Re-usable
- Suitable for use in circuits rated 35KV or less, proper high voltage spacing and insulation techniques must be used
- Rated for 90° C/194° F

Benefits

- Permits inventories to be kept to a minimum
- Time savings
- Easy inspection
- Provides efficient use and flexibility in the field
- Application versatility

C

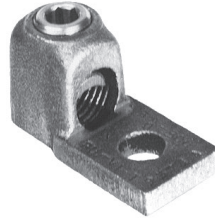
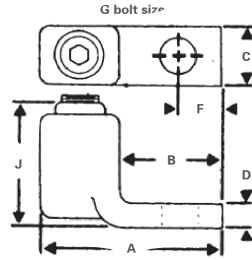

| Catalog Number | Wire Range | Dimensions (in.) | | | | | | |
|----------------|--------------------|------------------|---------|---------|--------|-------|---------|--------|
| | | G | A | B | C | D | J | F |
| CL-1-8† | 8-14 | 1/4 | 1-1/8 | 9/16 | 1/2 | 1/8 | 17/32 | 9/32 |
| CL-1-1 | 1-4 | 1/4 | 1-5/8 | 13/16 | 5/8 | 7/32 | 1 | 11/32 |
| CL-1-2/0 | 2/0-1 | 3/8 | 1-15/16 | 1 | 13/16 | 1/4 | 1-3/16 | 7/16 |
| CL-1-4/0 | 4/0-2/0 | 3/8 | 2-3/8 | 1-1/4 | 1 | 9/32 | 1-13/32 | 17/32 |
| CL-1-300 | 300kcmil-4/0 | 1/2 | 2-3/4 | 1-1/2 | 1-3/16 | 5/16 | 1-17/32 | 5/8 |
| CL-1-500 | 500kcmil-300kcmil | 1/2 | 3-1/16 | 1-11/16 | 1-3/8 | 11/32 | 1-13/16 | 3/4 |
| CL-1-750 | 750kcmil-500kcmil | 1/2 | 3-25/32 | 2-3/16 | 1-5/8 | 13/32 | 2-1/8 | 1 |
| CL-1-1000 | 1000kcmil-750kcmil | 5/8 | 4-5/16 | 2-15/32 | 1-7/8 | 15/32 | 2-11/32 | 1-3/16 |

All wire sizes, unless noted otherwise, are American Wire Gauge (AWG)

† With Filister head screw. All other, hex socket screw.

UL File E158587

Bronze, One Conductor Mechanical Lugs Two Mounting Hole

RoHS
Compliant

UL
LISTED
8M24

SA
AP-100973-1

TYPE
CL

Features

- Range taking
- Easily installed with a key wrench
- Convenient peep hole
- Re-usable
- Suitable for use in circuits rated 35KV or less, proper high voltage spacing and insulation techniques must be used
- Rated for 90° C/194° F

Benefits

- Permits inventories to be kept to a minimum
- Time savings
- Easy inspection
- Provides efficient use and flexibility in the field
- Application versatility

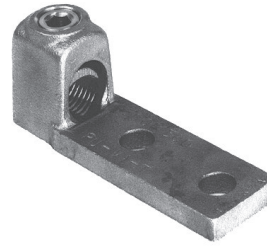
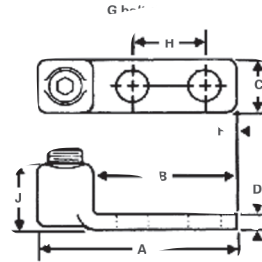

C

| Catalog Number | Wire Range | Dimensions (in.) | | | | | | | |
|----------------|--------------------|------------------|---------|-------|--------|-------|---------|------|-------|
| | | G | A | B | C | D | J | F | H |
| CL-1-2/0N | 2/0-1 | 1/2 | 3-15/16 | 3 | 1 | 1/4 | 11/16 | 9/16 | 1-3/4 |
| CL-1-4/0N | 4/0-2/0 | 1/2 | 4-1/8 | 3 | 1 | 9/32 | 1-9/32 | 9/16 | 1-3/4 |
| CL-1-300N | 300kcmil-4/0 | 1/2 | 4-3/16 | 3 | 1-3/16 | 5/16 | 1-15/32 | 9/16 | 1-3/4 |
| CL-1-500N | 500kcmil-300kcmil | 1/2 | 4-7/8 | 3-1/2 | 1-3/8 | 11/32 | 1-13/16 | 9/16 | 1-3/4 |
| CL-1-750N | 750kcmil-500kcmil | 1/2 | 5-3/32 | 3-1/2 | 1-3/4 | 13/32 | 2-1/8 | 9/16 | 1-3/4 |
| CL-1-1000N | 1000kcmil-750kcmil | 1/2 | 5-1/4 | 3-1/2 | 3 | 15/32 | 2-1/8 | 9/16 | 1-3/4 |

All wire sizes, unless noted otherwise, are American Wire Gauge (AWG)
Furnished with bolt holes and spacing to fit equipment supplied with NEMA type connector mounting pads.
UL File E158587

Bronze Mechanical Lugs

One Conductor

RoHS
Compliant



TYPE HL

Features

- Manufactured from high strength cast bronze
- Range taking
- Re-usable
- Pressure pad/saddle
- Suitable for use in circuits rated 35KV or less, proper high voltage spacing and insulation techniques must be used
- Rated for 90° C/194° F

Benefits

- Provides maximum conductivity and a high degree of breakage resistance
- Permits inventories to be kept to a minimum
- Provides efficient use and flexibility in the field
- Provides positive grip and low contact resistance.
- Application versatility

C

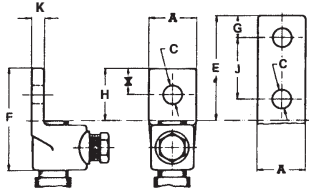

Fig. 1



Fig. 2

| Catalog Number | Fig. No. | Wire Range | Bolt Size | Dimensions (in.) | | | | | | | | |
|----------------|----------|-------------------|-----------|------------------|-------|-------|---------|-------|-------|-------|-------|--|
| | | | | A | C | E | F | G | H | J | K | |
| HL4-1 | 1 | 4 str-8 sol | 1/4 | 9/16 | 9/32 | 5/8 | 1-1/4 | 5/16 | 5/8 | - | 3/16 | |
| HL8-1 | 1 | 1str-4 sol | 1/4 | 3/4 | 9/32 | 11/16 | 1-9/16 | 11/32 | 11/16 | - | 7/32 | |
| HL13-1 | 1 | 2/0 str-1 str | 3/8 | 13/16 | 13/32 | 7/8 | 1-7/8 | 7/16 | 7/8 | - | 7/32 | |
| HL21-1 | 1 | 4/0 str-2/0 str | 3/8 | 1 | 7/16 | 1 | 2-3/16 | 1/2 | 1 | - | 1/4 | |
| HL30-1 | 1 | 300kcmil-4/0 str | 1/2 | 1-1/16 | 9/16 | 1-1/4 | 2-1/2 | 5/8 | 1-1/4 | - | 5/16 | |
| HL35-1 | 1 | 350kcmil-250kcmil | 1/2 | 1-3/16 | 9/16 | 1-1/4 | 2-9/16 | 5/8 | 1-1/4 | - | 5/16 | |
| HL50-1 | 1 | 500kcmil-300kcmil | 1/2 | 1-3/8 | 9/16 | 1-1/2 | 3 | 3/4 | 1-3/8 | - | 11/32 | |
| HL75-1 | 1 | 750kcmil-500kcmil | 5/8 | 1-5/8 | 11/16 | 1-3/4 | 3-7/16 | 7/8 | 1-3/4 | - | 3/8 | |
| HL35-2N | 2 | 350kcmil-250kcmil | 1/2 | 1-1/2 | 9/16 | 3 | 4-1/4 | 5/8 | 3 | 1-3/4 | 5/16 | |
| HL50-2N | 2 | 500kcmil-300kcmil | 1/2 | 1-1/2 | 9/16 | 3 | 4-7/16 | 5/8 | 3 | 1-3/4 | 11/32 | |
| HL75-2N | 2 | 750kcmil-500kcmil | 1/2 | 1-5/8 | 9/16 | 3 | 4-11/16 | 5/8 | 3 | 1-3/4 | 3/8 | |

All wire sizes, unless noted otherwise, are American Wire Gauge (AWG)
UL File E158587

Bronze Mechanical Lugs

Two and Three Conductor

RoHS
Compliant

UL
LISTED
8M24

SF
AP-100973-1

TYPE CL

Features

- Range taking
- Easily installed with a key wrench
- Convenient peep hole
- Re-usable
- Suitable for use in circuits rated 35KV or less, proper high voltage spacing and insulation techniques must be used
- Rated for 90° C/194° F

Benefits

- Permits inventories to be kept to a minimum
- Time savings
- Easy inspection
- Provides efficient use and flexibility in the field
- Application versatility

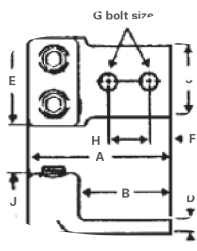

Fig. 1

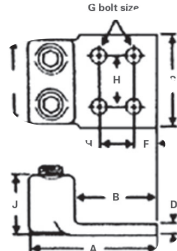

Fig. 2

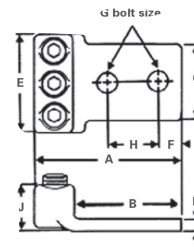
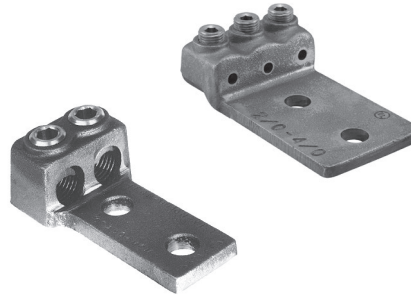

Fig. 3

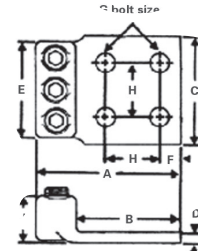

Fig. 4

C

| Catalog Number | Fig. No. | Wire Range | Dimensions (in.) | | | | | | | | | |
|----------------|----------|--------------------|------------------|---------|---------|-------|-------|---------|------|--------|---------|--|
| | | | G | A | B | C | D | E | F | H | J | |
| CL-2-8† | 1 | 8-14 | 1/4 | 2-3/16 | 1-3/4 | 5/8 | 1/8 | 11/16 | 9/32 | 5/8 | 15/32 | |
| CL-2-4† | 1 | 4-8 | 1/4 | 2-1/2 | 2 | 1 | 1/8 | 1 | 9/32 | 5/8 | 17/32 | |
| CL-2-1 | 1 | 1-4 | 3/8 | 2-13/16 | 2 | 1-1/4 | 7/32 | 1-1/4 | 7/16 | 1 | 19/32 | |
| CL-2-2/0 | 1 | 2/0-1 | 1/2 | 4-7/16 | 3-1/2 | 1-1/2 | 1/4 | 1-9/16 | 5/8 | 1-3/4 | 13/32 | |
| CL-2-4/0 | 1 | 4/0-2/0 | 1/2 | 4-5/8 | 3-1/2 | 1-3/4 | 9/32 | 1-3/4 | 5/8 | 1-3/4 | 15/16 | |
| CL-2-300 | 1 | 300kcmil-4/0 | 1/2 | 4-3/4 | 3-1/2 | 2 | 5/16 | 2-1/8 | 5/8 | 13-3/4 | 1-9/16 | |
| CL-2-500 | 1 | 500kcmil-300kcmil | 1/2 | 5-3/8 | 3-15/16 | 2-1/2 | 11/32 | 2-1/2 | 5/8 | 1-3/4 | 1-13/16 | |
| CL-2-700 | 2 | 700kcmil-500kcmil | 1/2 | 5-19/32 | 4 | 4 | 13/32 | 2-15/16 | 5/8 | 1-3/4 | 2-1/8 | |
| CL-2-1000 | 2 | 1000kcmil-750kcmil | 1/2 | 5-27/32 | 4 | 4 | 15/32 | 3-1/4 | 5/8 | 1-3/4 | 2-11/32 | |
| CL-3-4/0 | 3 | 4/0-2/0 | 1/2 | 4-5/8 | 3-3/8 | 2-1/2 | 9/32 | 2-3/4 | 5/8 | 1-3/4 | 15/16 | |
| CL-3-300 | 3 | 300kcmil-4/0 | 1/2 | 4-3/4 | 3-1/2 | 3 | 5/16 | 3-1/4 | 5/8 | 1-3/4 | 1-17/32 | |
| CL-3-500 | 4 | 500kcmil-300kcmil | 1/2 | 5-3/8 | 4 | 4 | 11/32 | 3-3/4 | 5/8 | 1-3/4 | 1-13/16 | |
| CL-3-750 | 4 | 750kcmil-500kcmil | 1/2 | 5-19/32 | 4 | 4 | 13/32 | 4-3/8 | 5/8 | 1-3/4 | 2-1/8 | |
| CL-3-1000 | 4 | 1000kcmil-750kcmil | 1/2 | 5-27/32 | 4 | 4 | 15/32 | 4-13/16 | 5/8 | 1-3/4 | 2-11/32 | |

All wire sizes, unless noted otherwise, are American Wire Gauge (AWG)

† With Filister Head Screw

UL File E158587

Bronze Mechanical Lugs

Two Conductor

RoHS
Compliant

UL
LISTED
8M24

TYPE H2L

Features

- Manufactured from high strength cast bronze
- Range taking
- Re-usable
- Compact design
- Pressure pad/saddle
- Suitable for use in circuits rated 35KV or less, proper high voltage spacing and insulation techniques must be used
- Rated for 90° C/194° F

Benefits

- Provides maximum conductivity and a high degree of breakage resistance
- Permits inventories to be kept to a minimum
- Provides efficient use and flexibility in the field
- Requires less space than two individual connectors
- Provides positive grip and low contact resistance
- Application versatility

C

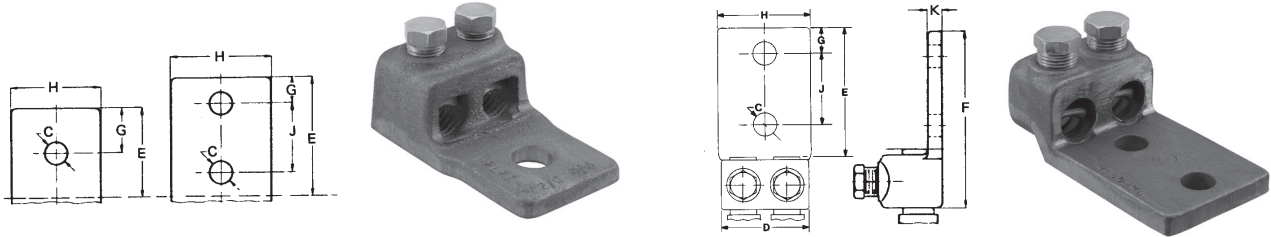

Fig. 1

Fig. 2

| Catalog Number | Fig. No. | Wire Range | | Bolt Size | Dimensions (in.) | | | | | | | |
|----------------|----------|------------|----------|-----------|------------------|--------|-------|---------|-----|-------|-------|------|
| | | Min. | Max. | | C | D | E | F | G | H | J | K |
| H2L-13-1 | 1 | 1 str | 2/0 str | 1/2 | 9/16 | 1-5/8 | 1-1/2 | 2-1/2 | 3/4 | 1-5/8 | - | 7/32 |
| H2L-21-1 | 1 | 2/0 str | 4/0 str | 1/2 | 9/16 | 1-3/4 | 1-3/4 | 2-15/16 | 7/8 | 1-7/8 | - | 5/16 |
| H2L-21-2N | 2 | 2/0 str | 4/0 str | 1/2 | 9/16 | 1-3/4 | 3 | 4-3/16 | 5/8 | 1-7/8 | 1-3/4 | 5/16 |
| H2L-30-2N | 2 | 4/0 str | 300kcmil | 1/2 | 9/16 | 2 | 3 | 4-3/8 | 5/8 | 2 | 1-3/4 | 5/16 |
| H2L-35-2N | 2 | 250kcmil | 350kcmil | 1/2 | 9/16 | 2-1/8 | 3 | 4-7/16 | 5/8 | 2-1/4 | 1-3/4 | 5/16 |
| H2L-50-2N | 2 | 300kcmil | 500kcmil | 1/2 | 9/16 | 2-7/16 | 3 | 4-1/2 | 5/8 | 2-1/2 | 1-3/4 | 3/8 |
| H2L-75-2N | 2 | 500kcmil | 750kcmil | 1/2 | 9/16 | 3-1/16 | 3 | 4-11/16 | 5/8 | 3 | 1-3/4 | 7/16 |

All wire sizes, unless noted otherwise, are American Wire Gauge (AWG)
UL File E158587

Bronze Mechanical Lugs

Three Conductor, Two Mounting Hole

RoHS
Compliant



TYPE H3L

Features

- Manufactured from high strength cast bronze
- Range taking
- Re-usable
- Compact design
- Pressure pad/saddle
- Suitable for use in circuits rated 35KV or less, proper high voltage spacing and insulation techniques must be used
- Rated for 90° C/194° F

Benefits

- Provides maximum conductivity and a high degree of breakage resistance
- Permits inventories to be kept to a minimum
- Provides efficient use and flexibility in the field
- Requires less space than three individual connectors
- Provides positive grip and low contact resistance
- Application versatility

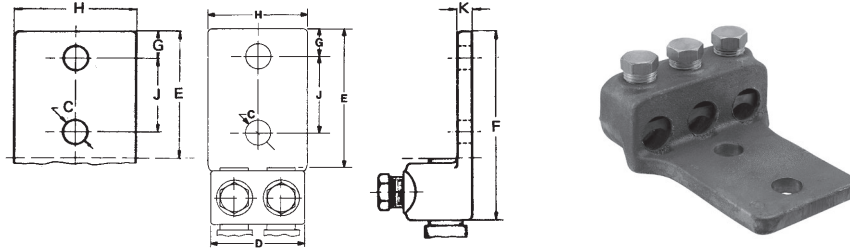

C

| Catalog Number | Wire Range | | Bolt Size | Dimensions (in.) | | | | | | | |
|----------------|------------|----------|-----------|------------------|--------|---|--------|-----|-------|-------|------|
| | Min. | Max. | | C | D | E | F | G | H | J | K |
| H3L-21-2N | 2/0 str | 4/0 str | 1/2 | 9/16 | 2-5/8 | 3 | 4-3/16 | 5/8 | 1-7/8 | 1-3/4 | 5/16 |
| H3L-30-2N | 4/0 str | 300kcmil | 1/2 | 9/16 | 3-1/16 | 3 | 4-3/8 | 5/8 | 2-3/8 | 1-3/4 | 5/16 |
| H3L-35-2N | 250kcmil | 350kcmil | 1/2 | 9/16 | 3-3/16 | 3 | 4-7/16 | 5/8 | 2-3/8 | 1-3/4 | 5/16 |
| H3L-50-2N | 300kcmil | 500kcmil | 1/2 | 9/16 | 3-5/8 | 3 | 4-1/2 | 5/8 | 2-1/2 | 1-3/4 | 3/8 |

All wire sizes, unless noted otherwise, are American Wire Gauge (AWG)
UL File E158587

Copper Neutral Bars

RoHS
Compliant



TYPE D167

Features

- Manufactured from high strength copper tubing
- Range taking
- UL Recognized for 600 volts

Benefits

- Provides maximum conductivity
- A wide range of conductor sizes can be used in the same connector
- Ensures reliability for copper conductor

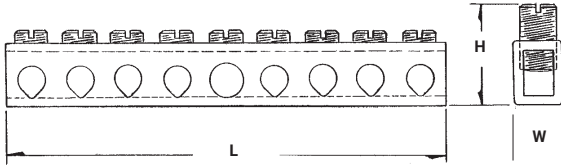

C

| Catalog Number | Number of Taps | Wire Range | | Dimensions (in.) | | | | | Mounting Hole Positions | |
|----------------|----------------|------------|------|------------------|--------------------------|-------|-----------|--------------------|----------------------------------------|------------------------|
| | | Main | Tap | L | Height With Maximum Wire | W | Bolt Size | Two Mounting Holes | From End Of Bar To First Mounting Hole | Distance Between Holes |
| D167-4 | 4 | 4-14 | 6-14 | 2-3/4 | 3/4 | 11/32 | #10 | 13/64 | .581 (2nd hole) | 1.98 |
| D167-6 | 6 | 4-14 | 6-14 | 3-1/2 | 3/4 | 11/32 | #10 | 13/64 | .978 (3rd hole) | 1.98 |
| D167-8 | 8 | 4-14 | 6-14 | 4-7/16 | 3/4 | 11/32 | #10 | 13/64 | 1.375 (4th hole) | 1.98 |
| D167-10 | 10 | 4-14 | 6-14 | 5-1/8 | 3/4 | 11/32 | #10 | 13/64 | 1.772 (5th hole) | 1.98 |
| D167-12 | 12 | 4-14 | 6-14 | 5-15/16 | 3/4 | 11/32 | #10 | 13/64 | 2.169 (6th hole) | 1.98 |
| D167-14 | 14 | 4-14 | 6-14 | 6-23/32 | 3/4 | 11/32 | #10 | 13/64 | 2.566 (7th hole) | 1.98 |

All wire sizes, unless noted otherwise, are American Wire Gauge (AWG)

Tested to UL 486A/B and UL 467, UL File E6207

Copper Neutral Bars

RoHS
Compliant



TYPE CAN

Features

- Manufactured from high strength copper tubing
- Compact design
- Range taking
- Circuit bars inserted at a 20 angle
- Copper conductor only

Benefits

- Provides maximum conductivity
- Up to 42 circuit taps can be made in just 5 1/2 in of space
- A wide range of conductor sizes can be used in the same connector
- Provides easy wire insertion

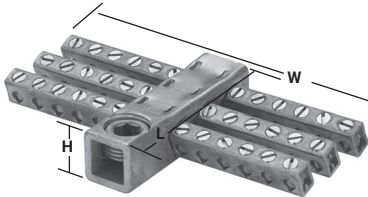

Fig. 1



Fig. 2



Fig. 3

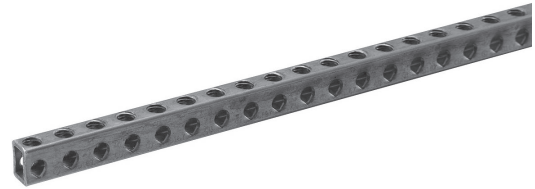

Fig. 4

C

| Catalog Number | Fig. No. | Number of Taps | Wire Range | | Dimensions (in.) | | | |
|----------------|----------|-------------------------------------------------------------------------------------------------------------------------------------------|------------|------|------------------|--------------------------|---------|---------------------------|
| | | | Main | Tap | L | Height With Maximum Wire | W | Two Tapped Mounting Holes |
| CAN-300 | 1 | 24 | 250kcmil-6 | 6-14 | 2-5/16 | 1-5/16 | 5-1/8 | 10-32 |
| CAN-301 | 1 | 30 | 250kcmil-6 | 6-14 | 3 | 1-5/16 | 4-13/32 | 10-32 |
| CAN-302 | 1 | 36 | 250kcmil-6 | 6-14 | 3 | 1-5/16 | 5-1/8 | 10-32 |
| CAN-303 | 1 | 42 | 250kcmil-6 | 6-14 | 3 | 1-7/16 | 5-1/2 | 10-32 |
| R-16 | 2 | Mounting block of general purpose (phenolic black) suitable for mounting any of CAN Neutrals. 2-1/2 in wide x 2-1/2 in long x 1 in thick. | | | | | | |
| E-223 | 3 | 10-32 x 1/2 in round head steel machine screws for fastening neutrals to mounting blocks. (Use lock washer to provide rigid assembly.) | | | | | | |
| E-153 | 3 | 1/4-28 wire pressure screw 7/16 in long. Screw is steel, zinc plated and chromate dipped. | | | | | | |
| N-174‡ | 4 | Supplied in 5' 9 in lengths. Approximately 174 outlets. Wire range 14-6. | | | | | | |

All wire sizes, unless noted otherwise, are American Wire Gauge (AWG)

Tested to UL 486A/B, UL File E6207

‡ Tested to UL 486A/B and UL 467, UL File E6207

Tin Plated Copper Split Bolts

RoHS
Compliant

UL
LISTED
460C

SA
LR-701570

TYPE
SK

Features

- Manufactured from high strength copper alloy
- Electro-tin plated bolt, nut, spacer and pressure bar
- Precision tooled threads
- SK-10, SK-8, SK3, SK-2 SK-1/0, SK-2/0 are RUS Accepted
- For use with copper conductor types: Solid, Compact, Compressed, Concentric
- Suitable for use in circuits rated 35KV or less, proper high voltage spacing and insulation techniques must be used
- Rated to 90° C/194° F

Benefits

- Provides maximum conductivity and high breakage resistance
- Provides low contact resistance
- Application versatility

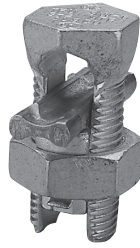
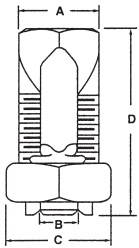

C



| Catalog Number | Range For Equal Main & Tap | Main Tap with One Max. Main | Max Cond Copperweld | | Wire Diameter Range | Dimensions (in.) | | | | Recommended Torque (IN-LB) |
|----------------|----------------------------------|-----------------------------|---------------------|--------|---------------------|------------------|-------|-------|-------|----------------------------|
| | | | Str | Type A | | A | B | C | D | |
| SK-10 | 10str - 16str | 16str | - | - | .057 - .116 | .144 | 0.375 | 0.500 | 0.844 | 80 |
| SK-8 | 8str - 16str | 16str | - | - | .057 - .145 | 0.144 | 0.375 | 0.500 | 0.844 | 80 |
| SK-6 + | 8str - 14str | 14str | - | - | .073 - .146 | .166 | 0.500 | 0.625 | 1.109 | 165 |
| SK-4 + | 6str - 10str | 10sol | 3 No. 12 | 8A | .116 - .184 | 0.217 | 0.562 | 0.688 | 1.266 | 165 |
| SK-3 + | 4str - 8sol AL 2sol - 8sol CU | 8sol AL 8sol CU | 3 No. 9 | 5A | .128 - .258 | 0.326 | 0.688 | 0.812 | 1.547 | 275 |
| SK-2 + | 2str - 8sol | 8sol | 3 No. 7 | 3A | .128 - .316 | 0.326 | 0.688 | 0.812 | 1.547 | 275 |
| SK-1/0 | 1/0str - 6sol | 10sol | 3 No. 6 | - | .162 - .375 | 0.376 | 0.750 | 0.875 | 1.641 | 385 |
| SK-2/0 | 2/0str - 6str | 10sol | 3 No. 5 | - | .184 - .419 | .420 | 0.812 | 1.000 | 1.812 | 385 |
| SK-3/0 | 3/0str - 4str | 6sol | 7 No. 7 | - | .198 - .470 | 0.466 | 0.875 | 1.125 | 2.000 | 500 |
| SK-250 | 250kcmil - 4str | 4str | 7 No. 5 | - | .232 - .575 | 0.577 | 1.000 | 1.312 | 2.328 | 650 |
| SK-350 | 350kcmil - 3/0str | 1sol | 19 No. 7 | - | .447 - .682 | 0.746 | 1.500 | 1.625 | 2.625 | 650 |
| SK-500 | 500kcmil - 3/0str | 1/0str | 19 No. 6 | - | .447 - .815 | 0.834 | 1.625 | 1.812 | 3.000 | 825 |
| SK-750 | 750kcmil - 250kcmil | 2/0str | 19 No. 5 | - | .563 - .999 | 1.030 | 1.938 | 2.125 | 3.750 | 1000 |
| SK-1000 | 1000kcmil - 350kcmil | 4/0str | - | - | .682 - 1.162 | 1.222 | 2.250 | 2.500 | 4.000 | 1100 |

All wire sizes, unless noted otherwise, are American Wire Gauge (AWG)
+ AL9CU
UL File E12822

INFORMATION SHEET TIGHTENING TORQUE VALUES FOR ILSCO MECHANICAL SCREW CONNECTORS

| WIRE SIZE | TIGHTENING TORQUE IN INCH POUNDS | |
|-----------|---------------------------------------------------------------------------------------------------|---------------------------------------------------------------------------------------------------------------|
| | SCREW DRIVER  | EXTERNAL DRIVE WRENCH  |
| 14 AWG | 35 | 75 |
| 12 AWG | 35 | 75 |
| 10 AWG | 35 | 75 |
| 8 AWG | 40 | 75 |
| 6 AWG | 45 | 110 |
| 4 AWG | 45 | 110 |
| 2 AWG | 50 | 150 |
| 1 AWG | 50 | 150 |
| 1/0 AWG | 50 | 180 |
| 2/0 AWG | 50 | 180 |
| 3/0 AWG | | 250 |
| 4/0 AWG | | 250 |
| 250kcmil | | 325 |
| 350kcmil | | 325 |
| 500kcmil | | 375 |
| 600kcmil | | 375 |
| 700kcmil | | 375 |
| 750kcmil | | 375 |
| 800kcmil | | 500 |
| 1000kcmil | | 500 |

FORM 1
Revised 9-21-2015

INFORMATION SHEET TIGHTENING TORQUE VALUES FOR ILSCO SOCKETHEAD SCREW CONNECTORS

| INTERNAL SOCKET SIZE ACROSS FLATS INCHES | TIGHTENING TORQUE IN INCH POUNDS  |
|------------------------------------------------|-------------------------------------------------------------------------------------------------------------------------|
| 1/8 | 45 |
| 5/32 | 100 |
| 3/16 | 120 |
| 7/32 | 150 |
| 1/4 | 200 |
| 5/16 | 275 |
| 3/8 | 375 |
| 1/2 | 500 |
| 9/16 | 600 |

FORM 1
Revised 9-21-2015

C

TIGHTENING TORQUE FOR CONNECTING HARDWARE















| SCREW OR BOLT SIZE | | TIGHTENING TORQUE | |
|--------------------|-------------------------|-------------------|-----------------|
| METRIC | SAE | N•m | (lbf•ft) |
| - | No. 8 or smaller | 2 | (1.5) 18 |
| - | No. 10 | 3 | (2.0) 24 |
| M6 | 1/4 | 8 | (6) 72 |

Please reference the instruction sheet included with your connector for specific torque values.

All wire sizes, unless noted otherwise, are American Wire Gauge (AWG)

* Torque information included with product supersedes this page.

Insulated Mechanical

| | | | |
|-----------------------------------------------------------------------------------------------------------------------|-----------------------------------------------------------------------------------------------------------------------|--------------------------------------------------------------------------------------------------------------------------|---------------------------------------------------------------------------------------------------------------------------|
| <p>PBT</p>  <p>210</p> | <p>PBTO</p>  <p>211</p> | <p>PBTD</p>  <p>212 - 214</p> | <p>PBTS</p>  <p>215 - 217</p> |
| <p>PBTM</p>  <p>218 - 219</p> | <p>PBTF</p>  <p>200 - 223</p> | <p>PBTT</p>  <p>224</p> | <p>PBTL</p>  <p>225</p> |
| <p>PBTX</p>  <p>226</p> | <p>PBT2</p>  <p>227</p> | <p>PBTI</p>  <p>228</p> | <p>PBTFML KIT</p> <p>229</p> |
| <p>Common 3-Phase AC Motor Wiring Diagrams</p> <p>230</p> | <p>ECT</p>  <p>231</p> | <p>ECTS</p>  <p>232 - 234</p> | <p>ECTD</p>  <p>235 - 238</p> |
| <p>PCT</p>  <p>239</p> | <p>SPAR</p>  <p>240</p> | <p>MAC</p>  <p>241</p> | |

nVent ILSCO Nimbus

Two Wire In-Line and Offset Insulated Splicer-Reducer Connectors



TYPE PBT

Features

- Broad wire range: 750kcmil-14
- UL Listed and CSA Certified for 600 volts, 90° C/194° F
- Dual rated
- Cold temperature rated to -45° C/-49° F
- High dielectric strength plastisol
- Black cover
- Removable plugs
- Prefilled with De-Ox

Benefits

- Flexibility in the field
- Ensures reliability
- For copper or aluminum conductor
- Application variability
- Chemical resistant
- UV Rated
- Entry port closure
- Prevents oxides from forming



| Catalog Number | Fig. No. | No. of Ports | Wire Range | Dimensions (in.) | | | Hex Size |
|----------------|----------|--------------|-------------------|------------------|------|------|----------|
| | | | | L | W | H | |
| PBT-1/0 | 1 | - | 1/0-14 | 3.11 | 0.94 | 1.44 | 3/16 |
| PBT-250 | 1 | - | 250kcmil-6 | 4.28 | 1.06 | 2.04 | 5/16 |
| PBT-350 | 1 | - | 350kcmil-6 | 4.75 | 1.31 | 2.43 | 5/16 |
| PBT-500 | 1 | - | 500kcmil-4 | 5.38 | 1.44 | 3.03 | 3/8 |
| PBT-750 | 3 | - | 750kcmil-250kcmil | 7.25 | 1.75 | 3.31 | 3/8 |
| PBTO-4 | 2 | 2 | 4-14 | 1.17 | 1.25 | 1.31 | 1/8 |
| PBTO-1/0 | 2 | 2 | 1/0-14 | 1.63 | 1.63 | 1.63 | 3/16 |
| PBTO-3/0 | 2 | 2 | 3/0-6 | 1.89 | 1.68 | 1.86 | 1/4 |

All wire sizes, unless noted otherwise, are American Wire Gauge (AWG)

Per NEC Article 310-316, allowable ampacities are as follows: #4-95 Amps, 1/0-170 Amps, 3/0-225 Amps, 250-290 Amps, 350-350 Amps, 500-430 Amps, 750-535 Amps

Replacement caps & plugs available. Consult Factory

Tested to UL 486A/B, UL File E6207

Nimbus

Insulated Multi-Tap Connectors

Dual Sided Entry

RoHS
Compliant

UL
LISTED
453G

CSA
LR-29601

TYPE PBTD

Features

- Broad wire range: 750kcmil-14
- UL Listed and CSA Certified for 600 volts, 90° C/194° F
- Dual rated
- Cold temperature rated to -45° C/-49° F
- High dielectric strength plastisol
- Black cover
- Removable plugs
- Prefilled with De-Ox

Benefits

- Flexibility in the field
- Ensures reliability
- For copper or aluminum conductor
- Application variability
- Chemical resistant
- UV Rated
- Entry port closure
- Prevents oxides from forming

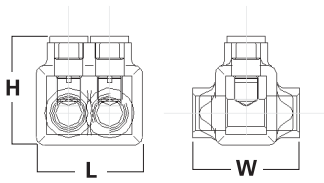

D

| Catalog Number | No. of Ports | Wire Range | Dimensions (in.) | | | Hex Size |
|----------------|--------------|------------|------------------|-------|-------|----------|
| | | | L | W | H | |
| PBTD-2-4 | 2 | 4-14 | 1.24 | 1.25 | 1.42 | 1/8 |
| PBTD-3-4 | 3 | 4-14 | 1.70 | 1.25 | 1.42 | 1/8 |
| PBTD-4-4 | 4 | 4-14 | 2.16 | 1.25 | 1.42 | 1/8 |
| PBTD-5-4 | 5 | 4-14 | 2.61 | 1.25 | 1.42 | 1/8 |
| PBTD-6-4 | 6 | 4-14 | 3.07 | 1.25 | 1.42 | 1/8 |
| PBTD-7-4 | 7 | 4-14 AWG | 3.53 | 1.394 | 1.42 | 1/8 |
| PBTD-8-4 | 8 | 4-14 AWG | 3.99 | 1.394 | 1.42 | 1/8 |
| PBTD-9-4 | 9 | 4-14 AWG | 4.45 | 1.394 | 1.42 | 1/8 |
| PBTD-10-4 | 10 | 4-14 AWG | 4.9 | 1.394 | 1.42 | 1/8 |
| PBTD-11-4 | 11 | 4-14 AWG | 5.36 | 1.394 | 1.42 | 1/8 |
| PBTD-12-4 | 12 | 4-14 AWG | 5.82 | 1.394 | 1.42 | 1/8 |
| PBTD-13-4 | 13 | 4-14 AWG | 6.28 | 1.394 | 1.42 | 1/8 |
| PBTD-14-4 | 14 | 4-14 AWG | 6.74 | 1.394 | 1.42 | 1/8 |
| PBTD-2-1/0 | 2 | 1/0-14 | 1.67 | 1.63 | 1.63 | 3/16 |
| PBTD-3-1/0 | 3 | 1/0-14 | 2.29 | 1.63 | 1.63 | 3/16 |
| PBTD-4-1/0 | 4 | 1/0-14 | 2.92 | 1.63 | 1.63 | 3/16 |
| PBTD-5-1/0 | 5 | 1/0-14 | 3.54 | 1.63 | 1.63 | 3/16 |
| PBTD-6-1/0 | 6 | 1/0-14 | 4.17 | 1.63 | 1.63 | 3/16 |
| PBTD-7-1/0 | 7 | 1/0-14 AWG | 4.748 | 1.825 | 1.63 | 3/16 |
| PBTD-8-1/0 | 8 | 1/0-14 AWG | 5.373 | 1.825 | 1.63 | 3/16 |
| PBTD-9-1/0 | 9 | 1/0-14 AWG | 5.998 | 1.825 | 1.63 | 3/16 |
| PBTD-10-1/0 | 10 | 1/0-14 AWG | 6.623 | 1.825 | 1.63 | 3/16 |
| PBTD-11-1/0 | 11 | 1/0-14 AWG | 7.248 | 1.825 | 1.63 | 3/16 |
| PBTD-12-1/0 | 12 | 1/0-14 AWG | 7.873 | 1.825 | 1.63 | 3/16 |
| PBTD-13-1/0 | 13 | 1/0-14 AWG | 8.498 | 1.825 | 1.63 | 3/16 |
| PBTD-14-1/0 | 14 | 1/0-14 AWG | 9.123 | 1.825 | 1.63 | 3/16 |
| PBTD-2-3/0 | 2 | 3/0-6 | 1.89 | 1.68 | 1.86 | 1/4 |
| PBTD-3-3/0 | 3 | 3/0-6 | 2.65 | 1.68 | 1.86 | 1/4 |
| PBTD-4-3/0 | 4 | 3/0-6 | 3.42 | 1.68 | 1.86 | 1/4 |
| PBTD-5-3/0 | 5 | 3/0-6 | 4.18 | 1.68 | 1.86 | 1/4 |
| PBTD-6-3/0 | 6 | 3/0-6 | 4.95 | 1.68 | 1.86 | 1/4 |
| PBTD-7-3/0 | 7 | 3/0-6 AWG | 5.71 | 2.277 | 2.019 | 1/4 |
| PBTD-8-3/0 | 8 | 3/0-6 AWG | 6.48 | 2.277 | 2.019 | 1/4 |
| PBTD-9-3/0 | 9 | 3/0-6 AWG | 7.24 | 2.277 | 2.019 | 1/4 |
| PBTD-10-3/0 | 10 | 3/0-6 AWG | 8.01 | 2.277 | 2.019 | 1/4 |
| PBTD-11-3/0 | 11 | 3/0-6 AWG | 8.77 | 2.277 | 2.019 | 1/4 |
| PBTD-12-3/0 | 12 | 3/0-6 AWG | 9.54 | 2.277 | 2.019 | 1/4 |
| PBTD-13-3/0 | 13 | 3/0-6 AWG | 10.3 | 2.277 | 2.019 | 1/4 |
| PBTD-14-3/0 | 14 | 3/0-6 AWG | 11.07 | 2.277 | 2.019 | 1/4 |

All wire sizes, unless noted otherwise, are American Wire Gauge (AWG)

For one input & multiple output configurations, the allowable ampacities per NEC Table 310.16 and 310.17 are as follows: #4-95 Amps, 1/0-170 Amps, 3/0-225 Amps, 250-290 Amps, 350-350 Amps, 600-475 Amps, 750-535 Amps. For multiple inputs, the inputs must be staggered with outputs to allow for ampacities to be additive per NEC Table 310.16 and 310.17.

Replacement caps & plugs available. Consult Factory Tested to UL 486A/B, UL File E6207

Nimbus

Insulated Multi-Tap Connectors

Dual Sided Entry

RoHS
Compliant

UL
LISTED
453G

CSA
LR-29601

TYPE PBTD

Features

- Broad wire range: 750kcmil-14
- UL Listed and CSA Certified for 600 volts, 90° C/194° F
- Dual rated
- Cold temperature rated to -45° C/-49° F
- High dielectric strength plastisol
- Black cover
- Removable plugs
- Prefilled with De-Ox

Benefits

- Flexibility in the field
- Ensures reliability
- For copper or aluminum conductor
- Application variability
- Chemical resistant
- UV Rated
- Entry port closure
- Prevents oxides from forming

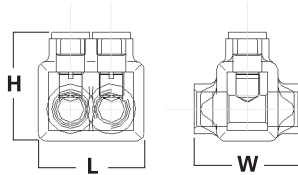

D

| Catalog Number | No. of Ports | Wire Range | Dimensions (in.) | | | Hex Size |
|----------------|--------------|-----------------|------------------|-------|-------|----------|
| | | | L | W | H | |
| PBTD-2-250 | 2 | 250kcmil-6 | 2.17 | 2.13 | 2.17 | 5/16 |
| PBTD-3-250 | 3 | 250kcmil-6 | 3.07 | 2.13 | 2.17 | 5/16 |
| PBTD-4-250 | 4 | 250kcmil-6 | 3.96 | 2.13 | 2.17 | 5/16 |
| PBTD-5-250 | 5 | 250kcmil-6 | 4.85 | 2.13 | 2.17 | 5/16 |
| PBTD-6-250 | 6 | 250kcmil-6 | 5.75 | 2.13 | 2.17 | 5/16 |
| PBTD-7-250 | 7 | 250 kcmil-6 AWG | 6.76 | 2.318 | 2.041 | 5/16 |
| PBTD-8-250 | 8 | 250 kcmil-6 AWG | 7.69 | 2.318 | 2.041 | 5/16 |
| PBTD-9-250 | 9 | 250 kcmil-6 AWG | 8.62 | 2.318 | 2.041 | 5/16 |
| PBTD-10-250 | 10 | 250 kcmil-6 AWG | 9.55 | 2.318 | 2.041 | 5/16 |
| PBTD-11-250 | 11 | 250 kcmil-6 AWG | 10.48 | 2.318 | 2.041 | 5/16 |
| PBTD-12-250 | 12 | 250 kcmil-6 AWG | 11.41 | 2.318 | 2.041 | 5/16 |
| PBTD-13-250 | 13 | 250 kcmil-6 AWG | 12.34 | 2.318 | 2.041 | 5/16 |
| PBTD-14-250 | 14 | 250 kcmil-6 AWG | 14.27 | 2.318 | 2.041 | 5/16 |
| PBTD-2-350 | 2 | 350kcmil-6 | 2.51 | 2.25 | 2.62 | 5/16 |
| PBTD-3-350 | 3 | 350kcmil-6 | 3.56 | 2.25 | 2.62 | 5/16 |
| PBTD-4-350 | 4 | 350kcmil-6 | 4.61 | 2.25 | 2.62 | 5/16 |
| PBTD-5-350 | 5 | 350kcmil-6 | 5.67 | 2.25 | 2.62 | 5/16 |
| PBTD-6-350 | 6 | 350kcmil-6 | 6.71 | 2.25 | 2.62 | 5/16 |
| PBTD-7-350 | 7 | 350 kcmil-6 AWG | 8.248 | 2.578 | 2.396 | 5/16 |
| PBTD-8-350 | 8 | 350 kcmil-6 AWG | 9.404 | 2.578 | 2.396 | 5/16 |
| PBTD-9-350 | 9 | 350 kcmil-6 AWG | 10.56 | 2.578 | 2.396 | 5/16 |
| PBTD-10-350 | 10 | 350 kcmil-6 AWG | 11.716 | 2.578 | 2.396 | 5/16 |
| PBTD-11-350 | 11 | 350 kcmil-6 AWG | 12.872 | 2.578 | 2.396 | 5/16 |
| PBTD-12-350 | 12 | 350 kcmil-6 AWG | 14.028 | 2.578 | 2.396 | 5/16 |
| PBTD-13-350 | 13 | 350 kcmil-6 AWG | 15.184 | 2.578 | 2.396 | 5/16 |
| PBTD-14-350 | 14 | 350 kcmil-6 AWG | 16.34 | 2.578 | 2.396 | 5/16 |

All wire sizes, unless noted otherwise, are American Wire Gauge (AWG)

For one input & multiple output configurations, the allowable ampacities per NEC Table 310.16 and 310.17 are as follows: #4-95 Amps, 1/0-170 Amps, 3/0-225 Amps, 250-290 Amps, 350-350 Amps, 600-475 Amps, 750-535 Amps.

For multiple inputs, the inputs must be staggered with outputs to allow for ampacities to be additive per NEC Table 310.16 and 310.17.

Replacement caps & plugs available. Consult Factory

Tested to UL 486A/B, UL File E6207

Nimbus

Insulated Multi-Tap Connectors

Dual Sided Entry

RoHS
Compliant

UL
LISTED
453G

CSA
LR-29601

TYPE PBTD

Features

- Broad wire range: 750kcmil-14
- UL Listed and CSA Certified for 600 volts, 90° C/194° F
- Dual rated
- Cold temperature rated to -45° C/-49° F
- High dielectric strength plastisol
- Black cover
- Removable plugs
- Prefilled with De-Ox

Benefits

- Flexibility in the field
- Ensures reliability
- For copper or aluminum conductor
- Application variability
- Chemical resistant
- UV Rated
- Entry port closure
- Prevents oxides from forming

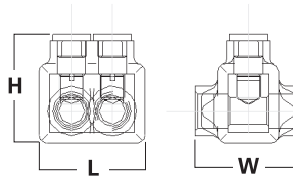

D

| Catalog Number | No. of Ports | Wire Range | Dimensions (in.) | | | Hex Size |
|----------------|--------------|---------------------|------------------|-------|-------|----------|
| | | | L | W | H | |
| PBTD-2-500 | 2 | 600kcmil-4 | 2.97 | 2.63 | 3.04 | 3/8 |
| PBTD-3-500 | 3 | 600kcmil-4 | 4.12 | 2.63 | 3.04 | 3/8 |
| PBTD-4-500 | 4 | 600kcmil-4 | 5.28 | 2.63 | 3.04 | 3/8 |
| PBTD-5-500 | 5 | 600kcmil-4 | 6.44 | 2.63 | 3.04 | 3/8 |
| PBTD-6-500 | 6 | 600kcmil-4 | 7.59 | 2.63 | 3.04 | 3/8 |
| PBTD-7-500 | 7 | 600 kcmil-4 AWG | 9.186 | 3.036 | 3.034 | 3/8 |
| PBTD-8-500 | 8 | 600 kcmil-4 AWG | 10.467 | 3.031 | 3.034 | 3/8 |
| PBTD-9-500 | 9 | 600 kcmil-4 AWG | 11.748 | 3.031 | 3.034 | 3/8 |
| PBTD-10-500 | 10 | 600 kcmil-4 AWG | 13.029 | 3.031 | 3.034 | 3/8 |
| PBTD-11-500 | 11 | 600 kcmil-4 AWG | 14.31 | 3.031 | 3.034 | 3/8 |
| PBTD-12-500 | 12 | 600 kcmil-4 AWG | 15.591 | 3.031 | 3.034 | 3/8 |
| PBTD-13-500 | 13 | 600 kcmil-4 AWG | 16.872 | 3.031 | 3.034 | 3/8 |
| PBTD-14-500 | 14 | 600 kcmil-4 AWG | 18.153 | 3.031 | 3.034 | 3/8 |
| PBTD-2-750 | 2 | 750kcmil-250kcmil | 3.47 | 3.25 | 3.31 | 1/2 |
| PBTD-3-750 | 3 | 750kcmil-250kcmil | 4.89 | 3.25 | 3.31 | 1/2 |
| PBTD-4-750 | 4 | 750kcmil-250kcmil | 6.32 | 3.25 | 3.31 | 1/2 |
| PBTD-5-750 | 5 | 750kcmil-250kcmil | 7.74 | 3.25 | 3.31 | 1/2 |
| PBTD-6-750 | 6 | 750kcmil-250kcmil | 9.16 | 3.25 | 3.31 | 1/2 |
| PBTD-7-750 | 7 | 750 kcmil-250 kcmil | 11.14 | 3.405 | 3.206 | 1/2 |
| PBTD-8-750 | 8 | 750 kcmil-250 kcmil | 12.7 | 3.405 | 3.206 | 1/2 |
| PBTD-9-750 | 9 | 750 kcmil-250 kcmil | 14.26 | 3.405 | 3.206 | 1/2 |
| PBTD-10-750 | 10 | 750 kcmil-250 kcmil | 15.82 | 3.405 | 3.206 | 1/2 |
| PBTD-11-750 | 11 | 750 kcmil-250 kcmil | 17.38 | 3.405 | 3.206 | 1/2 |
| PBTD-12-750 | 12 | 750 kcmil-250 kcmil | 18.94 | 3.405 | 3.206 | 1/2 |
| PBTD-13-750 | 13 | 750 kcmil-250 kcmil | 20.5 | 3.405 | 3.206 | 1/2 |
| PBTD-14-750 | 14 | 750 kcmil-250 kcmil | 22.06 | 3.405 | 3.206 | 1/2 |

All wire sizes, unless noted otherwise, are American Wire Gauge (AWG)

For one input & multiple output configurations, the allowable ampacities per NEC Table 310.16 and 310.17 are as follows: #4-95 Amps, 1/0-170 Amps, 3/0-225 Amps, 250-290 Amps, 350-350 Amps, 600-475 Amps, 750-535 Amps.

For multiple inputs, the inputs must be staggered with outputs to allow for ampacities to be additive per NEC Table 310.16 and 310.17.

Replacement caps & plugs available. Consult Factory

Tested to UL 486A/B, UL File E6207

Nimbus

Insulated Multi-Tap Connectors

Dual Sided Entry

RoHS
Compliant

UL
LISTED
453G

CSA
LR-29601

TYPE PBTD

Features

- Broad wire range: 250kcmil-6
- UL Listed and CSA Certified for 600 volts, 90° C/194° F
- Dual rated (Single conductor per wire port)
- Cold temperature rated to -45° C/-49° F
- High dielectric strength plastisol
- Black cover
- Removable plugs
- Prefilled with De-Ox

Benefits

- Flexibility in the field
- Ensures reliability
- For copper or aluminum conductor
- Application variability
- Chemical resistant
- UV Rated
- Entry port closure
- Prevents oxides from forming

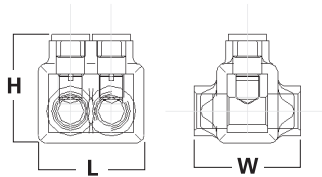

| Catalog Number | No. of Ports | Wire Range | Dimensions (in.) | | | Hex Size |
|----------------|--------------|-----------------|------------------|-------|-------|----------|
| | | | L | W | H | |
| PBTD-3-250-SR | 3 | 250 kcmil-6 AWG | 3.07 | 2.13 | 2.17 | 5/16 |
| PBTD-4-250-SR | 4 | 250 kcmil-6 AWG | 3.96 | 2.13 | 2.17 | 5/16 |
| PBTD-5-250-SR | 5 | 250 kcmil-6 AWG | 4.85 | 2.13 | 2.17 | 5/16 |
| PBTD-6-250-SR | 6 | 250 kcmil-6 AWG | 5.75 | 2.13 | 2.17 | 5/16 |
| PBTD-7-250-SR | 7 | 250 kcmil-6 AWG | 6.76 | 2.318 | 2.041 | 5/16 |
| PBTD-8-250-SR | 8 | 250 kcmil-6 AWG | 7.69 | 2.318 | 2.041 | 5/16 |
| PBTD-9-250-SR | 9 | 250 kcmil-6 AWG | 8.62 | 2.318 | 2.041 | 5/16 |
| PBTD-10-250-SR | 10 | 250 kcmil-6 AWG | 9.55 | 2.318 | 2.041 | 5/16 |
| PBTD-11-250-SR | 11 | 250 kcmil-6 AWG | 10.48 | 2.318 | 2.041 | 5/16 |
| PBTD-12-250-SR | 12 | 250 kcmil-6 AWG | 11.41 | 2.318 | 2.041 | 5/16 |
| PBTD-13-250-SR | 13 | 250 kcmil-6 AWG | 12.34 | 2.318 | 2.041 | 5/16 |
| PBTD-14-250-SR | 14 | 250 kcmil-6 AWG | 14.27 | 2.318 | 2.041 | 5/16 |

All wire sizes, unless noted otherwise, are American Wire Gauge (AWG)

For one input & multiple output configurations, the allowable ampacities per NEC Table 310.16 and 310.17 are as follows: #4-95 Amps, 1/0-170 Amps, 3/0-225 Amps, 250-290 Amps, 350-350 Amps, 600-475 Amps, 750-535 Amps.

For multiple inputs, the inputs must be staggered with outputs to allow for ampacities to be additive per NEC Table 310.16 and 310.17.

Replacement caps & plugs available. Consult Factory

Tested to UL 486A/B, UL File E6207

Suitable for use on the line side of the service equipment
Compliant with NEC 230.46

D

Nimbus

Insulated Multi-Tap Connectors

Single Sided Entry

RoHS
Compliant

UL
LISTED
453G

CSA
LR-29601

TYPE PBTS

Features

- Broad wire range: 750kcmil-14
- UL Listed and CSA Certified for 600 volts, 90° C/194° F
- Dual rated
- Cold temperature rated to -45° C/-49° F
- High dielectric strength plastisol
- Black cover
- Removable plugs
- Prefilled with De-Ox

Benefits

- Flexibility in the field
- Ensures reliability
- For copper or aluminum conductor
- Application variability
- Chemical resistant
- UV Rated
- Entry port closure
- Prevents oxides from forming

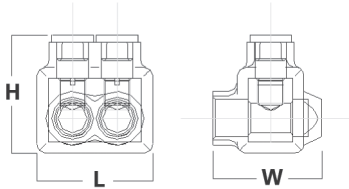

D

| Catalog Number | No. of Ports | Wire Range | Dimensions (in.) | | | Hex Size |
|----------------|--------------|------------|------------------|-------|-------|----------|
| | | | L | W | H | |
| PBTS-2-4 | 2 | 4-14 | 1.24 | 1.22 | 1.42 | 1/8 |
| PBTS-3-4 | 3 | 4-14 | 1.70 | 1.22 | 1.42 | 1/8 |
| PBTS-4-4 | 4 | 4-14 | 2.16 | 1.22 | 1.42 | 1/8 |
| PBTS-5-4 | 5 | 4-14 | 2.61 | 1.22 | 1.42 | 1/8 |
| PBTS-6-4 | 6 | 4-14 | 3.07 | 1.22 | 1.42 | 1/8 |
| PBTS-7-4 | 7 | 4-14 AWG | 3.458 | 1.32 | 1.379 | 1/8 |
| PBTS-8-4 | 8 | 4-14 AWG | 3.916 | 1.32 | 1.379 | 1/8 |
| PBTS-9-4 | 9 | 4-14 AWG | 4.374 | 1.32 | 1.379 | 1/8 |
| PBTS-10-4 | 10 | 4-14 AWG | 4.832 | 1.32 | 1.379 | 1/8 |
| PBTS-11-4 | 11 | 4-14 AWG | 5.29 | 1.32 | 1.379 | 1/8 |
| PBTS-12-4 | 12 | 4-14 AWG | 5.748 | 1.32 | 1.379 | 1/8 |
| PBTS-13-4 | 13 | 4-14 AWG | 6.206 | 1.32 | 1.379 | 1/8 |
| PBTS-14-4 | 14 | 4-14 AWG | 6.664 | 1.32 | 1.379 | 1/8 |
| PBTS-2-1/0 | 2 | 1/0-14 | 1.67 | 1.53 | 1.63 | 3/16 |
| PBTS-3-1/0 | 3 | 1/0-14 | 2.29 | 1.53 | 1.63 | 3/16 |
| PBTS-4-1/0 | 4 | 1/0-14 | 2.92 | 1.53 | 1.63 | 3/16 |
| PBTS-5-1/0 | 5 | 1/0-14 | 3.54 | 1.53 | 1.63 | 3/16 |
| PBTS-6-1/0 | 6 | 1/0-14 | 4.17 | 1.53 | 1.63 | 3/16 |
| PBTS-7-1/0 | 7 | 1/0-14 AWG | 4.748 | 1.62 | 1.63 | 3/16 |
| PBTS-8-1/0 | 8 | 1/0-14 AWG | 5.373 | 1.62 | 1.63 | 3/16 |
| PBTS-9-1/0 | 9 | 1/0-14 AWG | 5.998 | 1.62 | 1.63 | 3/16 |
| PBTS-10-1/0 | 10 | 1/0-14 AWG | 6.67 | 1.53 | 1.63 | 3/16 |
| PBTS-11-1/0 | 11 | 1/0-14 AWG | 7.248 | 1.62 | 1.63 | 3/16 |
| PBTS-12-1/0 | 12 | 1/0-14 AWG | 7.873 | 1.62 | 1.63 | 3/16 |
| PBTS-13-1/0 | 13 | 1/0-14 AWG | 8.498 | 1.62 | 1.63 | 3/16 |
| PBTS-14-1/0 | 14 | 1/0-14 AWG | 9.123 | 1.53 | 1.63 | 3/16 |
| PBTS-2-3/0 | 2 | 3/0-6 | 1.89 | 1.58 | 1.86 | 1/4 |
| PBTS-3-3/0 | 3 | 3/0-6 | 2.65 | 1.58 | 1.86 | 1/4 |
| PBTS-4-3/0 | 4 | 3/0-6 | 3.42 | 1.58 | 1.86 | 1/4 |
| PBTS-5-3/0 | 5 | 3/0-6 | 4.18 | 1.58 | 1.86 | 1/4 |
| PBTS-6-3/0 | 6 | 3/0-6 | 4.95 | 1.58 | 1.86 | 1/4 |
| PBTS-7-3/0 | 7 | 3/0-6 AWG | 5.71 | 1.726 | 1.86 | 1/4 |
| PBTS-8-3/0 | 8 | 3/0-6 AWG | 6.48 | 1.726 | 1.86 | 1/4 |
| PBTS-9-3/0 | 9 | 3/0-6 AWG | 7.24 | 1.726 | 1.86 | 1/4 |
| PBTS-10-3/0 | 10 | 3/0-6 AWG | 8 | 1.726 | 1.86 | 1/4 |
| PBTS-11-3/0 | 11 | 3/0-6 AWG | 8.77 | 1.726 | 1.86 | 1/4 |
| PBTS-12-3/0 | 12 | 3/0-6 AWG | 9.54 | 1.726 | 1.86 | 1/4 |
| PBTS-13-3/0 | 13 | 3/0-6 AWG | 10.3 | 1.726 | 1.86 | 1/4 |
| PBTS-14-3/0 | 14 | 3/0-6 AWG | 11.07 | 1.726 | 1.86 | 1/4 |

All wire sizes, unless noted otherwise, are American Wire Gauge (AWG)

For one input & multiple output configurations, the allowable ampacities per NEC Table 310.16 and 310.17 are as follows: #4-95 Amps, 1/0-170 Amps, 3/0-225 Amps, 250-290 Amps, 350-350 Amps, 600-475 Amps, 750-535 Amps.

For multiple inputs, the inputs must be staggered with outputs to allow for ampacities to be additive per NEC Table 310.16 and 310.17.

Replacement caps & plugs available. Consult Factory Tested to UL 486A/B, UL File E6207

Nimbus

Insulated Multi-Tap Connectors

Single Sided Entry



TYPE PBTS

Features

- Broad wire range: 750kcmil-14
- UL Listed and CSA Certified for 600 volts, 90° C/194° F
- Dual rated
- Cold temperature rated to -45° C/-49° F
- High dielectric strength plastisol
- Black cover
- Removable plugs
- Prefilled with De-Ox

Benefits

- Flexibility in the field
- Ensures reliability
- For copper or aluminum conductor
- Application variability
- Chemical resistant
- UV Rated
- Entry port closure
- Prevents oxides from forming

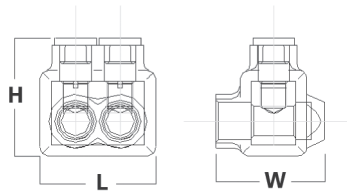

| Catalog Number | No. of Ports | Wire Range | Dimensions (in.) | | | Hex Size |
|----------------|--------------|-----------------|------------------|-------|-------|----------|
| | | | L | W | H | |
| PBTS-2-250 | 2 | 250kcmil-6 | 2.17 | 1.91 | 2.17 | 5/16 |
| PBTS-3-250 | 3 | 250kcmil-6 | 3.07 | 1.91 | 2.17 | 5/16 |
| PBTS-4-250 | 4 | 250kcmil-6 | 3.96 | 1.91 | 2.17 | 5/16 |
| PBTS-5-250 | 5 | 250kcmil-6 | 4.85 | 1.91 | 2.17 | 5/16 |
| PBTS-6-250 | 6 | 250kcmil-6 | 5.75 | 1.91 | 2.17 | 5/16 |
| PBTS-7-250 | 7 | 250 kcmil-6 AWG | 6.744 | 1.94 | 2.041 | 5/16 |
| PBTS-8-250 | 8 | 250 kcmil-6 AWG | 7.674 | 1.94 | 2.041 | 5/16 |
| PBTS-9-250 | 9 | 250 kcmil-6 AWG | 8.604 | 1.94 | 2.041 | 5/16 |
| PBTS-10-250 | 10 | 250 kcmil-6 AWG | 9.534 | 1.94 | 2.041 | 5/16 |
| PBTS-11-250 | 11 | 250 kcmil-6 AWG | 10.464 | 1.94 | 2.041 | 5/16 |
| PBTS-12-250 | 12 | 250 kcmil-6 AWG | 11.394 | 1.94 | 2.041 | 5/16 |
| PBTS-13-250 | 13 | 250 kcmil-6 AWG | 12.334 | 1.94 | 2.041 | 5/16 |
| PBTS-14-250 | 14 | 250 kcmil-6 AWG | 13.254 | 1.94 | 2.041 | 5/16 |
| PBTS-2-350 | 2 | 350kcmil-6 | 2.51 | 2.03 | 2.62 | 5/16 |
| PBTS-3-350 | 3 | 350kcmil-6 | 3.56 | 2.03 | 2.62 | 5/16 |
| PBTS-4-350 | 4 | 350kcmil-6 | 4.61 | 2.03 | 2.62 | 5/16 |
| PBTS-5-350 | 5 | 350kcmil-6 | 5.66 | 2.03 | 2.62 | 5/16 |
| PBTS-6-350 | 6 | 350kcmil-6 | 6.71 | 2.03 | 2.62 | 5/16 |
| PBTS-7-350 | 7 | 350 kcmil-6 AWG | 8.31 | 2.414 | 2.62 | 5/16 |
| PBTS-8-350 | 8 | 350 kcmil-6 AWG | 9.466 | 2.414 | 2.62 | 5/16 |
| PBTS-9-350 | 9 | 350 kcmil-6 AWG | 10.622 | 2.414 | 2.62 | 5/16 |
| PBTS-10-350 | 10 | 350 kcmil-6 AWG | 11.778 | 2.414 | 2.62 | 5/16 |
| PBTS-11-350 | 11 | 350 kcmil-6 AWG | 12.934 | 2.414 | 2.62 | 5/16 |
| PBTS-12-350 | 12 | 350 kcmil-6 AWG | 14.09 | 2.414 | 2.62 | 5/16 |
| PBTS-13-350 | 13 | 350 kcmil-6 AWG | 15.246 | 2.414 | 2.62 | 5/16 |
| PBTS-14-350 | 14 | 350 kcmil-6 AWG | 16.402 | 2.414 | 2.62 | 5/16 |

All wire sizes, unless noted otherwise, are American Wire Gauge (AWG)

For one input & multiple output configurations, the allowable ampacities per NEC Table 310.16 and 310.17 are as follows: #4-95 Amps, 1/0-170 Amps, 3/0-225 Amps, 250-290 Amps, 350-350 Amps, 600-475 Amps, 750-535 Amps.

For multiple inputs, the inputs must be staggered with outputs to allow for ampacities to be additive per NEC Table 310.16 and 310.17.

Replacement caps & plugs available. Consult Factory

Tested to UL 486A/B, UL File E6207

D

Nimbus

Insulated Multi-Tap Connectors

Single Sided Entry

RoHS
Compliant

UL
LISTED
453G

SA
LR-29601

TYPE PBTS

Features

- Broad wire range: 750kcmil-14
- UL Listed and CSA Certified for 600 volts, 90° C/194° F
- Dual rated
- Cold temperature rated to -45° C/-49° F
- High dielectric strength plastisol
- Black cover
- Removable plugs
- Prefilled with De-Ox

Benefits

- Flexibility in the field
- Ensures reliability
- For copper or aluminum conductor
- Application variability
- Chemical resistant
- UV Rated
- Entry port closure
- Prevents oxides from forming

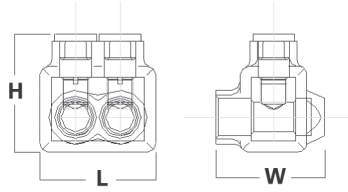

D

| Catalog Number | No. of Ports | Wire Range | Dimensions (in.) | | | Hex Size |
|----------------|--------------|---------------------|------------------|-------|-------|----------|
| | | | L | W | H | |
| PBTS-2-500 | 2 | 600kcmil-4 | 2.97 | 2.28 | 3.04 | 3/8 |
| PBTS-3-500 | 3 | 600kcmil-4 | 4.12 | 2.58 | 3.04 | 3/8 |
| PBTS-4-500 | 4 | 600kcmil-4 | 5.28 | 2.28 | 3.04 | 3/8 |
| PBTS-5-500 | 5 | 600kcmil-4 | 6.44 | 2.28 | 3.04 | 3/8 |
| PBTS-6-500 | 6 | 600kcmil-4 | 7.59 | 2.28 | 3.04 | 3/8 |
| PBTS-7-500 | 7 | 600 kcmil-4 AWG | 9.186 | 2.484 | 3.034 | 3/8 |
| PBTS-8-500 | 8 | 600 kcmil-4 AWG | 10.467 | 2.484 | 3.034 | 3/8 |
| PBTS-9-500 | 9 | 600 kcmil-4 AWG | 11.748 | 2.484 | 3.034 | 3/8 |
| PBTS-10-500 | 10 | 600 kcmil-4 AWG | 13.029 | 2.484 | 3.034 | 3/8 |
| PBTS-11-500 | 11 | 600 kcmil-4 AWG | 14.31 | 2.484 | 3.034 | 3/8 |
| PBTS-12-500 | 12 | 600 kcmil-4 AWG | 15.591 | 2.484 | 3.034 | 3/8 |
| PBTS-13-500 | 13 | 600 kcmil-4 AWG | 16.872 | 2.484 | 3.034 | 3/8 |
| PBTS-14-500 | 14 | 600 kcmil-4 AWG | 18.153 | 2.484 | 3.034 | 3/8 |
| PBTS-2-750 | 2 | 750kcmil-250kcmil | 3.47 | 2.75 | 3.31 | 1/2 |
| PBTS-3-750 | 3 | 750kcmil-250kcmil | 4.89 | 2.75 | 3.31 | 1/2 |
| PBTS-4-750 | 4 | 750kcmil-250kcmil | 6.32 | 2.75 | 3.31 | 1/2 |
| PBTS-5-750 | 5 | 750kcmil-250kcmil | 7.74 | 2.75 | 3.31 | 1/2 |
| PBTS-6-750 | 6 | 750kcmil-250kcmil | 9.16 | 2.75 | 3.31 | 1/2 |
| PBTS-7-750 | 7 | 750 kcmil-250 kcmil | 11.14 | 2.89 | 3.206 | 1/2 |
| PBTS-8-750 | 8 | 750 kcmil-250 kcmil | 13.7 | 2.89 | 3.206 | 1/2 |
| PBTS-9-750 | 9 | 750 kcmil-250 kcmil | 14.26 | 2.89 | 3.206 | 1/2 |
| PBTS-10-750 | 10 | 750 kcmil-250 kcmil | 15.82 | 2.89 | 3.206 | 1/2 |
| PBTS-11-750 | 11 | 750 kcmil-250 kcmil | 17.38 | 2.89 | 3.206 | 1/2 |
| PBTS-12-750 | 12 | 750 kcmil-250 kcmil | 18.94 | 2.89 | 3.206 | 1/2 |
| PBTS-13-750 | 13 | 750 kcmil-250 kcmil | 20.5 | 2.89 | 3.206 | 1/2 |
| PBTS-14-750 | 14 | 750 kcmil-250 kcmil | 28.06 | 2.89 | 3.206 | 1/2 |

All wire sizes, unless noted otherwise, are American Wire Gauge (AWG)

For one input & multiple output configurations, the allowable ampacities per NEC Table 310.16 and 310.17 are as follows: #4-95 Amps, 1/0-170 Amps, 3/0-225 Amps, 250-290 Amps, 350-350 Amps, 600-475 Amps, 750-535 Amps.

For multiple inputs, the inputs must be staggered with outputs to allow for ampacities to be additive per NEC Table 310.16 and 310.17.

Replacement caps & plugs available. Consult Factory

Tested to UL 486A/B, UL File E6207

Nimbus Mountable Insulated Multi-Tap Connectors Dual Sided Entry

RoHS
Compliant

UL
LISTED
453G

CSA
LR-29601

TYPE PBTM

Features

- Mountable
- Broad wire range: 750kcmil-6
- UL Listed and CSA Certified for 600 volts, 90° C/194° F
- Dual rated
- Cold temperature rated to -45° C/-49° F
- High dielectric strength plastisol
- Black cover
- Removable plugs
- Prefilled with De-Ox

Benefits

- Isolated mounting in trough, wire way or panels
- Flexibility in the field
- Ensures reliability
- For copper or aluminum conductor
- Application variability
- Chemical resistant
- UV Rated
- Entry port closure
- Prevents oxides from forming

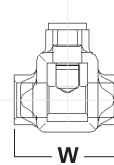
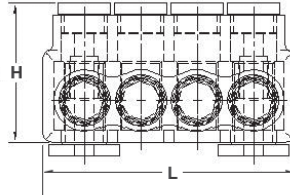

| Catalog Number | No. of Ports | Wire Range | Dimensions (in.) | | | Hex Size | Mounting Holes |
|----------------|--------------|-----------------|------------------|-------|-------|----------|----------------|
| | | | L | W | H | | |
| PBTD-2-3/0-M | 2 | 3/0-6 | 3.42 | 1.68 | 1.86 | 3/16 | 1/4 |
| PBTD-3-3/0-M | 3 | 3/0-6 | 4.18 | 1.68 | 1.86 | 3/16 | 1/4 |
| PBTD-4-3/0-M | 4 | 3/0-6 | 4.95 | 1.68 | 1.86 | 3/16 | 1/4 |
| PBTD-5-3/0-M | 5 | 3/0-6 | 5.71 | 1.68 | 1.86 | 3/16 | 1/4 |
| PBTD-6-3/0-M | 6 | 3/0-6 | 6.48 | 1.68 | 1.86 | 3/16 | 1/4 |
| PBTD-7-3/0-M | 7 | 3/0-6 AWG | 7.24 | 2.277 | 2.175 | 1/4 | 1/4 |
| PBTD-8-3/0-M | 8 | 3/0-6 AWG | 8.01 | 2.277 | 2.175 | 1/4 | 1/4 |
| PBTD-9-3/0-M | 9 | 3/0-6 AWG | 8.77 | 2.277 | 2.175 | 1/4 | 1/4 |
| PBTD-10-3/0-M | 10 | 3/0-6 AWG | 9.54 | 2.277 | 2.175 | 1/4 | 1/4 |
| PBTD-11-3/0-M | 11 | 3/0-6 AWG | 10.3 | 2.277 | 2.175 | 1/4 | 1/4 |
| PBTD-12-3/0-M | 12 | 3/0-6 AWG | 11.07 | 2.277 | 2.175 | 1/4 | 1/4 |
| PBTD-2-250-M | 2 | 250kcmil-6 | 3.96 | 2.13 | 2.17 | 5/16 | 1/4 |
| PBTD-3-250-M | 3 | 250kcmil-6 | 4.85 | 2.13 | 2.17 | 5/16 | 1/4 |
| PBTD-4-250-M | 4 | 250kcmil-6 | 5.75 | 2.13 | 2.17 | 5/16 | 1/4 |
| PBTD-5-250-M | 5 | 250kcmil-6 | 6.64 | 2.13 | 2.17 | 5/16 | 1/4 |
| PBTD-6-250-M | 6 | 250kcmil-6 | 7.53 | 2.13 | 2.17 | 5/16 | 1/4 |
| PBTD-7-250-M | 7 | 250 kcmil-6 AWG | 8.62 | 2.318 | 2.197 | 5/16 | 1/4 |
| PBTD-8-250-M | 8 | 250 kcmil-6 AWG | 9.56 | 2.318 | 2.197 | 5/16 | 1/4 |
| PBTD-9-250-M | 9 | 250 kcmil-6 AWG | 10.48 | 2.318 | 2.197 | 5/16 | 1/4 |
| PBTD-10-250-M | 10 | 250 kcmil-6 AWG | 11.41 | 2.318 | 2.197 | 5/16 | 1/4 |
| PBTD-11-250-M | 11 | 250 kcmil-6 AWG | 12.34 | 2.318 | 2.197 | 5/16 | 1/4 |
| PBTD-12-250-M | 12 | 250 kcmil-6 AWG | 12.89 | 2.13 | 2.17 | 5/16 | 1/4 |
| PBTD-2-350-M | 2 | 350kcmil-6 | 4.61 | 2.25 | 2.62 | 5/16 | 5/16 |
| PBTD-3-350-M | 3 | 350kcmil-6 | 5.67 | 2.25 | 2.62 | 5/16 | 5/16 |
| PBTD-4-350-M | 4 | 350kcmil-6 | 6.71 | 2.25 | 2.62 | 5/16 | 5/16 |
| PBTD-5-350-M | 5 | 350kcmil-6 | 7.76 | 2.25 | 2.62 | 5/16 | 5/16 |
| PBTD-6-350-M | 6 | 350kcmil-6 | 8.81 | 2.25 | 2.62 | 5/16 | 5/16 |
| PBTD-7-350-M | 7 | 350 kcmil-6 AWG | 10.622 | 2.578 | 2.583 | 5/16 | 5/16 |
| PBTD-8-350-M | 8 | 350 kcmil-6 AWG | 11.778 | 2.578 | 2.583 | 5/16 | 5/16 |
| PBTD-9-350-M | 9 | 350 kcmil-6 AWG | 12.934 | 2.578 | 2.583 | 5/16 | 5/16 |
| PBTD-10-350-M | 10 | 350 kcmil-6 AWG | 14.09 | 2.578 | 2.583 | 5/16 | 5/16 |
| PBTD-11-350-M | 11 | 350 kcmil-6 AWG | 15.246 | 2.578 | 2.583 | 5/16 | 5/16 |
| PBTD-12-350-M | 12 | 350 kcmil-6 AWG | 16.402 | 2.578 | 2.583 | 5/16 | 5/16 |

All wire sizes, unless noted otherwise, are American Wire Gauge (AWG)

For one input & multiple output configurations, the allowable ampacities per NEC Table 310.16 and 310.17 are as follows: #4-95 Amps, 1/0-170 Amps, 3/0-225 Amps, 250-290 Amps, 350-350 Amps, 600-475 Amps, 750-535 Amps.

For multiple inputs, the inputs must be staggered with outputs to allow for ampacities to be additive per NEC Table 310.16 and 310.17.

Replacement caps & plugs available. Consult Factory. Tested to UL 486A/B, UL File E6207

D

Nimbus Mountable Insulated Multi-Tap Connectors Dual Sided Entry

RoHS
Compliant

UL
LISTED
453G

CSA
LR-29601

TYPE PBTM

Features

- Mountable
- Broad wire range: 750kcmil-6
- UL Listed and CSA Certified for 600 volts, 90° C/194° F
- Dual rated
- Cold temperature rated to -45° C/-49° F
- High dielectric strength plastisol
- Black cover
- Removable plugs
- Prefilled with De-Ox

Benefits

- Isolated mounting in trough, wire way or panels
- Flexibility in the field
- Ensures reliability
- For copper or aluminum conductor
- Application variability
- Chemical resistant
- UV Rated
- Entry port closure
- Prevents oxides from forming

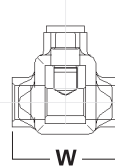
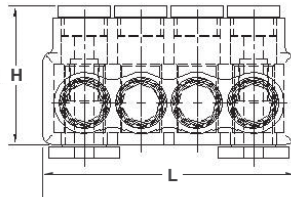

D

| Catalog Number | No. of Ports | Wire Range | Dimensions (in.) | | | Hex Size | Mounting Holes |
|----------------|--------------|---------------------|------------------|-------|-------|----------|----------------|
| | | | L | W | H | | |
| PBTD-2-500-M | 2 | 600kcmil-4 | 5.28 | 2.63 | 3.04 | 3/8 | 5/16 |
| PBTD-3-500-M | 3 | 600kcmil-4 | 6.44 | 2.63 | 3.04 | 3/8 | 5/16 |
| PBTD-4-500-M | 4 | 600kcmil-4 | 7.59 | 2.63 | 3.04 | 3/8 | 5/16 |
| PBTD-5-500-M | 5 | 600kcmil-4 | 8.75 | 2.63 | 3.04 | 3/8 | 5/16 |
| PBTD-6-500-M | 6 | 600kcmil-4 | 9.90 | 2.63 | 3.04 | 3/8 | 5/16 |
| PBTD-7-500-M | 7 | 600 kcmil-4 AWG | 11.748 | 3.031 | 3.19 | 3/8 | 5/16 |
| PBTD-8-500-M | 8 | 600 kcmil-4 AWG | 13.029 | 3.031 | 3.19 | 3/8 | 5/16 |
| PBTD-9-500-M | 9 | 600 kcmil-4 AWG | 14.31 | 3.031 | 3.19 | 3/8 | 5/16 |
| PBTD-10-500-M | 10 | 600 kcmil-4 AWG | 15.591 | 3.031 | 3.19 | 3/8 | 5/16 |
| PBTD-11-500-M | 11 | 600 kcmil-4 AWG | 16.872 | 3.031 | 3.19 | 3/8 | 5/16 |
| PBTD-12-500-M | 12 | 600 kcmil-4 AWG | 18.153 | 3.031 | 3.19 | 3/8 | 5/16 |
| PBTD-2-750-M | 2 | 750kcmil-250kcmil | 6.32 | 3.25 | 3.31 | 1/2 | 3/8 |
| PBTD-3-750-M | 3 | 750kcmil-250kcmil | 7.74 | 3.25 | 3.31 | 1/2 | 3/8 |
| PBTD-4-750-M | 4 | 750kcmil-250kcmil | 9.16 | 3.25 | 3.31 | 1/2 | 3/8 |
| PBTD-5-750-M | 5 | 750kcmil-250kcmil | 10.58 | 3.25 | 3.31 | 1/2 | 3/8 |
| PBTD-6-750-M | 6 | 750kcmil-250kcmil | 12.00 | 3.25 | 3.31 | 1/2 | 3/8 |
| PBTD-7-750-M | 7 | 750 kcmil-250 kcmil | 14.26 | 3.405 | 3.581 | 1/2 | 3/8 |
| PBTD-8-750-M | 8 | 750 kcmil-250 kcmil | 15.82 | 3.405 | 3.581 | 1/2 | 3/8 |
| PBTD-9-750-M | 9 | 750 kcmil-250 kcmil | 17.38 | 3.405 | 3.581 | 1/2 | 3/8 |
| PBTD-10-750-M | 10 | 750 kcmil-250 kcmil | 18.94 | 3.405 | 3.581 | 1/2 | 3/8 |
| PBTD-11-750-M | 11 | 750 kcmil-250 kcmil | 20.5 | 3.405 | 3.581 | 1/2 | 3/8 |
| PBTD-12-750-M | 12 | 750 kcmil-250 kcmil | 22.06 | 3.405 | 3.581 | 1/2 | 3/8 |

All wire sizes, unless noted otherwise, are American Wire Gauge (AWG)

For one input & multiple output configurations, the allowable ampacities per NEC Table 310.16 and 310.17 are as follows: #4-95 Amps, 1/0-170 Amps, 3/0-225 Amps, 250-290 Amps, 350-350 Amps, 600-475 Amps, 750-535 Amps.

For multiple inputs, the inputs must be staggered with outputs to allow for ampacities to be additive per NEC Table 310.16 and 310.17.

Replacement caps & plugs available. Consult Factory.

Tested to UL 486A/B, UL File E6207

Nimbus 4 Flex

Two Wire In-Line and Offset Insulated Splicer-Reducer Connectors

RoHS
Compliant

UL
LISTED
453G

SA
LR-29601

TYPE PBTf

Features

- Broad wire range: 750kcmil-14
- UL Listed and CSA Certified for 600 volts, 90° C/194° F
- Dual rated
- Cold temperature rated to -45° C/-49° F
- High dielectric strength plastisol
- Black cover
- Removable plugs
- Prefilled with De-Ox
- Patented screw design
- Nimbus Flexible caps are Reflex Blue

Benefits

- Flexibility in the field
- Ensures reliability
- For copper or aluminum conductor
- Application variability
- Chemical resistant
- UV Rated
- Entry port closure
- Prevents oxides from forming
- Improves vibration resistance, compresses conductor without damage, eliminates ferrules
- Easy identification in the field

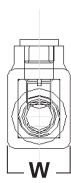
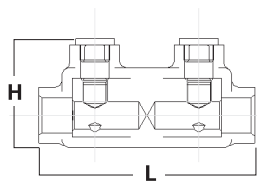

Fig. 1



Fig. 2

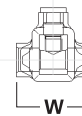

Fig. 3

D

| Catalog Number | Fig. No. | No. of Ports | Flex Conductor Range | Alternate Conductor Range | Dimensions (in.) | | | Hex Size |
|----------------|----------|--------------|--------------------------------------------|---------------------------|------------------|------|------|----------|
| | | | | | L | W | H | |
| PBT-1/0-F | 1 | - | 1-14 H,I,K,DLO 2-14 M - | 1/0-14 | 3.11 | 0.94 | 1.44 | 3/16 |
| PBT-250-F | 1 | - | 4/06 H,I,K 2/0-6 M 3/0-6 DLO | 250kcmil-6 | 4.28 | 1.06 | 2.04 | 1/4 |
| PBT-350-F | 1 | - | 250kcmil-6 H,I,K 4/0-6 M 262.2-6 DLO | 350kcmil-6 | 4.75 | 1.31 | 2.43 | 5/16 |
| PBT-500-F | 1 | - | 350kcmil-4 H,I,K 4/0-4 M 373.3-4 DLO | 500kcmil-4 | 5.38 | 1.44 | 3.03 | 3/8 |
| PBT-750-F | 3 | - | 500kcmil-3/0 H,I,K 4/0-3/0 M 535.3-3/0 DLO | 750kcmil-4/0 | 7.25 | 1.75 | 3.31 | 1/2 |
| PBTO-4-F | 2 | 2 | 8-14 H,I,K,M,DLO - - | 4-14 | 1.17 | 1.25 | 1.31 | 1/8 |
| PBTO-1/0-F | 2 | 2 | 1-14 H,I,K,DLO - 2-14 M | 1/0-14 | 1.63 | 1.63 | 1.63 | 3/16 |
| PBTO-3/0-F | 2 | 2 | 2/0-6 H,I,K,DLO - 1-6 M | 3/0-6 | 1.89 | 1.68 | 1.86 | 1/4 |

All wire sizes, unless noted otherwise, are American Wire Gauge (AWG)

Per NEC Article 310-316, allowable ampacities are as follows: #4-95 Amps, 1/0-170 Amps, 3/0-225 Amps, 250-290 Amps, 350-350 Amps, 500-430 Amps, 750-535 Amps

Replacement caps & plugs available. Consult Factory

Tested to UL 486A/B, UL File E6207

Nimbus 4 Flex

Flexible Multi-Tap Connectors, Single Side Entry



TYPE PBTF

Features

- Broad wire range: 750kcmil-14
- UL 486A/B Listed for 600 volts, 90° C/194° F
- Dual rated
- Cold temperature rated to -45° C/-49° F
- High dielectric strength plastisol
- Black cover
- Removable plugs
- Prefilled with De-Ox
- Nimbus Flexible caps are Reflex Blue
- Patented screw design

Benefits

- Flexibility in the field
- Ensures reliability
- For copper, copper flex or aluminum conductor
- Application variability
- Chemical resistant
- UV Rated
- Entry port closure
- Prevents oxides from forming
- Easy identification in the field
- Improves vibration resistance, compresses conductor without damage, eliminates the need for ferrules



D

| Catalog Number | No. of Ports | Wire Range | Alternate Wire Range | Ampere Rating | Dimensions (in.) | | | Hex Size |
|----------------|--------------|---------------------------------------|----------------------|---------------|------------------|------|------|----------|
| | | | | | L | W | H | |
| PBTS-2-4-F+ | 2 | 8-14 H,I,K,M,DLO | 4-14 AWG | 95 | 1.24 | 1.22 | 1.42 | 1/8 |
| PBTS-3-4-F | 3 | 8-14 H,I,K,M,DLO | 4-14 AWG | 95 | 1.70 | 1.22 | 1.42 | 1/8 |
| PBTS-4-4-F | 4 | 8-14 H,I,K,M,DLO | 4-14 AWG | 95 | 2.16 | 1.22 | 1.42 | 1/8 |
| PBTS-6-4-F | 6 | 8-14 H,I,K,M,DLO | 4-14 AWG | 95 | 3.07 | 1.22 | 1.42 | 1/8 |
| PBTS-2-1/0-F | 2 | 1-14 H,I,K DLO 2-14 M | 1/0-14 AWG | 170 | 1.67 | 1.53 | 1.63 | 3/16 |
| PBTS-3-1/0-F | 3 | 1-14 H,I,K DLO 2-14 M | 1/0-14 AWG | 170 | 2.29 | 1.53 | 1.63 | 3/16 |
| PBTS-4-1/0-F | 4 | 1-14 H,I,K DLO 2-14 M | 1/0-14 AWG | 170 | 2.92 | 1.53 | 1.63 | 3/16 |
| PBTS-6-1/0-F | 6 | 1-14 H,I,K DLO 2-14 M | 1/0-14 AWG | 170 | 4.17 | 1.53 | 1.63 | 3/16 |
| PBTS-2-3/0-F | 2 | 2/0-6 H,I,K,DLO 1-6 M | 3/0-6 AWG | 225 | 1.89 | 1.58 | 1.86 | 1/4 |
| PBTS-3-3/0-F | 3 | 2/0-6 H,I,K,DLO 1-6 M | 3/0-6 AWG | 225 | 2.65 | 1.58 | 1.86 | 1/4 |
| PBTS-4-3/0-F | 4 | 2/0-6 H,I,K,DLO 1-6 M | 3/0-6 AWG | 225 | 3.42 | 1.58 | 1.86 | 1/4 |
| PBTS-6-3/0-F | 6 | 2/0-6 H,I,K,DLO 1-6 M | 3/0-6 AWG | 225 | 4.95 | 1.58 | 1.86 | 1/4 |
| PBTS-2-250-F | 2 | 4/0-6 H,I,K 2/0-6 M 3/0-6 DLO | 250kcmil-6 AWG | 290 | 2.17 | 1.91 | 2.17 | 1/4 |
| PBTS-3-250-F | 3 | 4/0-6 H,I,K 2/0-6 M 3/0-6 DLO | 250kcmil-6 AWG | 290 | 3.07 | 1.91 | 2.17 | 1/4 |
| PBTS-4-250-F | 4 | 4/0-6 H,I,K 2/0-6 M 3/0-6 DLO | 250kcmil-6 AWG | 290 | 3.96 | 1.91 | 2.17 | 1/4 |
| PBTS-6-250-F | 6 | 4/0-6 H,I,K 2/0-6 M 3/0-6 DLO | 250kcmil-6 AWG | 290 | 5.75 | 1.91 | 2.17 | 1/4 |
| PBTS-2-350-F | 2 | 250-6 H,I,K 4/0-6 M 262.2-6 DLO | 350kcmil-6 AWG | 350 | 2.51 | 2.03 | 2.62 | 5/16 |
| PBTS-3-350-F | 3 | 250-6 H,I,K 4/0-6 M 262.2-6 DLO | 350kcmil-6 AWG | 350 | 3.56 | 2.03 | 2.62 | 5/16 |
| PBTS-4-350-F | 4 | 250-6 H,I,K 4/0-6 M 262.2-6 DLO | 350kcmil-6 AWG | 350 | 4.61 | 2.03 | 2.62 | 5/16 |
| PBTS-6-350-F | 6 | 250-6 H,I,K 4/0-6 M 262.2-6 DLO | 350kcmil-6 AWG | 350 | 6.71 | 2.03 | 2.62 | 5/16 |
| PBTS-2-500-F | 2 | 350-4 H,I,K 4/0-4 M 373.7-4 DLO | 600kcmil-4 AWG | 475 | 2.78 | 2.38 | 3.03 | 3/8 |
| PBTS-3-500-F | 3 | 350-4 H,I,K 4/0-4 M 373.7-4 DLO | 600kcmil-4 AWG | 475 | 4.06 | 2.38 | 3.03 | 3/8 |
| PBTS-4-500-F | 4 | 350-4 H,I,K 4/0-4 M 373.7-4 DLO | 600kcmil-4 AWG | 475 | 5.34 | 2.38 | 3.03 | 3/8 |
| PBTS-6-500-F | 6 | 350-4 H,I,K 4/0-4 M 373.7-4 DLO | 600kcmil-4 AWG | 475 | 7.91 | 2.38 | 3.03 | 3/8 |
| PBTS-2-750-F | 2 | 500-3/0 H,I,K 4/0-3/0 M 535.3-3/0 DLO | 750kcmil-4/0 AWG | 535 | 3.34 | 2.69 | 3.06 | 1/2 |
| PBTS-3-750-F | 3 | 500-3/0 H,I,K 4/0-3/0 M 535.3-3/0 DLO | 750kcmil-4/0 AWG | 535 | 4.90 | 2.69 | 3.06 | 1/2 |
| PBTS-4-750-F | 4 | 500-3/0 H,I,K 4/0-3/0 M 535.3-3/0 DLO | 750kcmil-4/0 AWG | 535 | 6.46 | 2.69 | 3.06 | 1/2 |
| PBTS-6-750-F | 6 | 500-3/0 H,I,K 4/0-3/0 M 535.3-3/0 DLO | 750kcmil-4/0 AWG | 535 | 9.58 | 2.69 | 3.06 | 1/2 |

All wire sizes, unless noted otherwise, are American Wire Gauge (AWG)

For one input & multiple output configurations, the allowable ampacities per NEC Table 310.16 and 310.17 are as follows: #4-95 Amps, 1/0-170 Amps, 3/0-225 Amps, 250-290 Amps, 350-350 Amps, 600-475 Amps, 750-535 Amps.

For multiple inputs, the inputs must be staggered with outputs to allow for ampacities to be additive per NEC Table 310.16 and 310.17.

Tested to UL 486A/B, UL File E6207 +Standard hex screw

Nimbus 4 Flex

Flexible Multi-Tap Connectors, Dual Sided Entry

RoHS
Compliant

UL
LISTED
453G

SA
LR-29601

TYPE
PBTF

Features

- Broad wire range: 750kcmil-14
- UL 486A/B Listed for 600 volts, 90° C/194° F
- Dual rated
- Cold temperature rated to -45° C/-49° F
- High dielectric strength plastisol
- Black cover
- Removable plugs
- Prefilled with De-Ox
- Nimbus Flexible caps are Reflex Blue
- Patented screw design

Benefits

- Flexibility in the field
- Ensures reliability
- For copper, copper flex or aluminum conductor
- Application variability
- Chemical resistant
- UV Rated
- Entry port closure
- Prevents oxides from forming
- Easy identification in the field
- Improves vibration resistance, compresses conductor without damage, eliminates the need for ferrules



D

| Catalog Number | No. of Ports | Wire Range | Alternate Wire Range | Ampere Rating | Dimensions (in.) | | | Hex Size |
|----------------|--------------|---------------------------------------|----------------------|---------------|------------------|------|------|----------|
| | | | | | L | W | H | |
| PBTD-2-4-F+ | 2 | 8-14 H,I,K,M,DLO | 4-14 AWG | 95 | 1.24 | 1.25 | 1.42 | 1/8 |
| PBTD-3-4-F | 3 | 8-14 H,I,K,M,DLO | 4-14 AWG | 95 | 1.70 | 1.25 | 1.42 | 1/8 |
| PBTD-4-4-F | 4 | 8-14 H,I,K,M,DLO | 4-14 AWG | 95 | 2.16 | 1.25 | 1.42 | 1/8 |
| PBTD-6-4-F | 6 | 8-14 H,I,K,M,DLO | 4-14 AWG | 95 | 3.07 | 1.24 | 1.42 | 1/8 |
| PBTD-2-1/0-F | 2 | 1-14 H,I,K DLO 2-14 M | 1/0-14 AWG | 170 | 1.67 | 1.63 | 1.63 | 3/16 |
| PBTD-3-1/0-F | 3 | 1-14 H,I,K DLO 2-14 M | 1/0-14 AWG | 170 | 2.29 | 1.63 | 1.63 | 3/16 |
| PBTD-4-1/0-F | 4 | 1-14 H,I,K DLO 2-14 M | 1/0-14 AWG | 170 | 2.92 | 1.63 | 1.63 | 3/16 |
| PBTD-6-1/0-F | 6 | 1-14 H,I,K DLO 2-14 M | 1/0-14 AWG | 170 | 4.17 | 1.63 | 1.63 | 3/16 |
| PBTD-2-3/0-F | 2 | 2/0-6 H,I,K,DLO 1-6 M | 3/0-6 AWG | 225 | 1.89 | 1.68 | 1.86 | 1/4 |
| PBTD-3-3/0-F | 3 | 2/0-6 H,I,K,DLO 1-6 M | 3/0-6 AWG | 225 | 2.65 | 1.68 | 1.86 | 1/4 |
| PBTD-4-3/0-F | 4 | 2/0-6 H,I,K,DLO 1-6 M | 3/0-6 AWG | 225 | 3.42 | 1.68 | 1.86 | 1/4 |
| PBTD-6-3/0-F | 6 | 2/0-6 H,I,K,DLO 1-6 M | 3/0-6 AWG | 225 | 4.95 | 1.68 | 1.86 | 1/4 |
| PBTD-2-250-F | 2 | 4/0-6 H,I,K 2/0-6 M 3/0-6 DLO | 250kcmil-6 AWG | 290 | 2.17 | 2.13 | 2.17 | 1/4 |
| PBTD-3-250-F | 3 | 4/0-6 H,I,K 2/0-6 M 3/0-6 DLO | 250kcmil-6 AWG | 290 | 3.07 | 2.13 | 2.17 | 1/4 |
| PBTD-4-250-F | 4 | 4/0-6 H,I,K 2/0-6 M 3/0-6 DLO | 250kcmil-6 AWG | 290 | 3.96 | 2.13 | 2.17 | 1/4 |
| PBTD-6-250-F | 6 | 4/0-6 H,I,K 2/0-6 M 3/0-6 DLO | 250kcmil-6 AWG | 290 | 5.75 | 2.13 | 2.17 | 1/4 |
| PBTD-2-350-F | 2 | 250-6 H,I,K 4/0-6 M 262.2-6 DLO | 350kcmil-6 AWG | 350 | 2.51 | 2.25 | 2.62 | 5/16 |
| PBTD-3-350-F | 3 | 250-6 H,I,K 4/0-6 M 262.2-6 DLO | 350kcmil-6 AWG | 350 | 3.56 | 2.25 | 2.62 | 5/16 |
| PBTD-4-350-F | 4 | 250-6 H,I,K 4/0-6 M 262.2-6 DLO | 350kcmil-6 AWG | 350 | 4.61 | 2.25 | 2.62 | 5/16 |
| PBTD-6-350-F | 6 | 250-6 H,I,K 4/0-6 M 262.2-6 DLO | 350kcmil-6 AWG | 350 | 6.71 | 2.25 | 2.62 | 5/16 |
| PBTD-2-500-F | 2 | 350-4 H,I,K 4/0-4 M 373.7-4 DLO | 600kcmil-4 AWG | 475 | 2.47 | 2.63 | 2.63 | 3/8 |
| PBTD-3-500-F | 3 | 350-4 H,I,K 4/0-4 M 373.7-4 DLO | 600kcmil-4 AWG | 475 | 3.75 | 2.63 | 2.63 | 3/8 |
| PBTD-4-500-F | 4 | 350-4 H,I,K 4/0-4 M 373.7-4 DLO | 600kcmil-4 AWG | 475 | 5.03 | 2.63 | 2.63 | 3/8 |
| PBTD-6-500-F | 6 | 350-4 H,I,K 4/0-4 M 373.7-4 DLO | 600kcmil-4 AWG | 475 | 7.59 | 2.63 | 2.63 | 3/8 |
| PBTD-2-750-F | 2 | 500-3/0 H,I,K 4/0-3/0 M 535.3-3/0 DLO | 750kcmil-4/0 AWG | 535 | 3.34 | 3.25 | 3.21 | 1/2 |
| PBTD-3-750-F | 3 | 500-3/0 H,I,K 4/0-3/0 M 535.3-3/0 DLO | 750kcmil-4/0 AWG | 535 | 4.90 | 3.25 | 3.21 | 1/2 |
| PBTD-4-750-F | 4 | 500-3/0 H,I,K 4/0-3/0 M 535.3-3/0 DLO | 750kcmil-4/0 AWG | 535 | 6.46 | 3.25 | 3.21 | 1/2 |
| PBTD-6-750-F | 6 | 500-3/0 H,I,K 4/0-3/0 M 535.3-3/0 DLO | 750kcmil-4/0 AWG | 535 | 9.58 | 3.25 | 3.21 | 1/2 |

All wire sizes, unless noted otherwise, are American Wire Gauge (AWG)

For one input & multiple output configurations, the allowable ampacities per NEC Table 310.16 and 310.17 are as follows:

#4-95 Amps, 1/0-170 Amps, 3/0-225 Amps, 250-290 Amps, 350-350 Amps, 600-475 Amps, 750-535 Amps.

For multiple inputs, the inputs must be staggered with outputs to allow for ampacities to be additive per NEC Table 310.16 and 310.17.

Tested to UL 486A/B, UL File E6207 +Standard hex screw

Nimbus 4 Flex

Mountable Flexible Multi-Tap Connectors, Dual Sided Entry



TYPE PBTF

Features

- Broad wire range: 750kcmil-14
- UL 486A/B Listed for 600 volts, 90° C/194° F
- Dual rated
- Cold temperature rated to -45° C/-49° F
- High dielectric strength plastisol
- Black cover
- Removable plugs
- Prefilled with De-Ox
- Nimbus Flexible caps are Reflex Blue
- Patented screw design

Benefits

- Flexibility in the field
- Ensures reliability
- For copper, copper flex or aluminum conductor
- Application variability
- Chemical resistant
- UV Rated
- Entry port closure
- Prevents oxides from forming
- Easy identification in the field
- Improves vibration resistance, compresses conductor without damage, eliminates the need for ferrules



D

| Catalog Number | No. of Ports* | Wire Range | Alternate Wire Range | Ampere Rating | Dimensions (in.) | | | Hex Size |
|----------------|---------------|---------------------------------------|----------------------|---------------|------------------|------|------|----------|
| | | | | | L | W | H | |
| PBTD-2-3/0-M-F | 2 | 2/0-6 H,I,K,DLO 1-6 M | 3/0-6 AWG | 225 | 3.42 | 1.68 | 1.86 | 1/4 |
| PBTD-3-3/0-M-F | 3 | 2/0-6 H,I,K,DLO 1-6 M | 3/0-6 AWG | 225 | 4.18 | 1.68 | 1.86 | 1/4 |
| PBTD-4-3/0-M-F | 4 | 2/0-6 H,I,K,DLO 1-6 M | 3/0-6 AWG | 225 | 4.95 | 1.68 | 1.86 | 1/4 |
| PBTD-6-3/0-M-F | 6 | 2/0-6 H,I,K,DLO 1-6 M | 3/0-6 AWG | 225 | 6.48 | 1.68 | 1.86 | 1/4 |
| PBTD-2-250-M-F | 2 | 4/0-6 H,I,K 2/0-6 M 3/0-6 DLO | 250kcmil-6 AWG | 290 | 3.96 | 2.13 | 2.17 | 5/16 |
| PBTD-3-250-M-F | 3 | 4/0-6 H,I,K 2/0-6 M 3/0-6 DLO | 250kcmil-6 AWG | 290 | 4.85 | 2.13 | 2.17 | 5/16 |
| PBTD-4-250-M-F | 4 | 4/0-6 H,I,K 2/0-6 M 3/0-6 DLO | 250kcmil-6 AWG | 290 | 5.73 | 2.13 | 2.17 | 5/16 |
| PBTD-6-250-M-F | 6 | 4/0-6 H,I,K 2/0-6 M 3/0-6 DLO | 250kcmil-6 AWG | 290 | 7.53 | 2.13 | 2.17 | 5/16 |
| PBTD-2-350-M-F | 2 | 250-6 H,I,K 4/0-6 M 262.2-6 DLO | 350kcmil-6 AWG | 350 | 4.61 | 2.25 | 2.62 | 5/16 |
| PBTD-3-350-M-F | 3 | 250-6 H,I,K 4/0-6 M 262.2-6 DLO | 350kcmil-6 AWG | 350 | 5.67 | 2.25 | 2.62 | 5/16 |
| PBTD-4-350-M-F | 4 | 250-6 H,I,K 4/0-6 M 262.2-6 DLO | 350kcmil-6 AWG | 350 | 6.71 | 2.25 | 2.62 | 5/16 |
| PBTD-6-350-M-F | 6 | 250-6 H,I,K 4/0-6 M 262.2-6 DLO | 350kcmil-6 AWG | 350 | 8.81 | 2.25 | 2.62 | 5/16 |
| PBTD-2-500-M-F | 2 | 350-4 H,I,K 4/0-4 M 373.7-4 DLO | 600kcmil-4 AWG | 475 | 5.34 | 3.03 | 3.20 | 3/8 |
| PBTD-3-500-M-F | 3 | 350-4 H,I,K 4/0-4 M 373.7-4 DLO | 600kcmil-4 AWG | 475 | 6.62 | 3.03 | 3.20 | 3/8 |
| PBTD-4-500-M-F | 4 | 350-4 H,I,K 4/0-4 M 373.7-4 DLO | 600kcmil-4 AWG | 475 | 7.41 | 3.03 | 3.20 | 3/8 |
| PBTD-6-500-M-F | 6 | 350-4 H,I,K 4/0-4 M 373.7-4 DLO | 600kcmil-4 AWG | 475 | 10.47 | 3.03 | 3.20 | 3/8 |
| PBTD-2-750-M-F | 2 | 500-3/0 H,I,K 4/0-3/0 M 535.3-3/0 DLO | 750kcmil-4/0 AWG | 535 | 6.46 | 3.25 | 3.58 | 1/2 |
| PBTD-3-750-M-F | 3 | 500-3/0 H,I,K 4/0-3/0 M 535.3-3/0 DLO | 750kcmil-4/0 AWG | 535 | 8.02 | 3.25 | 3.58 | 1/2 |
| PBTD-4-750-M-F | 4 | 500-3/0 H,I,K 4/0-3/0 M 535.3-3/0 DLO | 750kcmil-4/0 AWG | 535 | 9.58 | 3.25 | 3.58 | 1/2 |
| PBTD-6-750-M-F | 6 | 500-3/0 H,I,K 4/0-3/0 M 535.3-3/0 DLO | 750kcmil-4/0 AWG | 535 | 12.70 | 3.25 | 3.58 | 1/2 |

All wire sizes, unless noted otherwise, are American Wire Gauge (AWG)

For one input & multiple output configurations, the allowable ampacities per NEC Table 310.16 and 310.17 are as follows: #4-95 Amps, 1/0-170 Amps, 3/0-225 Amps, 250-290 Amps, 350-350 Amps, 600-475 Amps, 750-535 Amps.

For multiple inputs, the inputs must be staggered with outputs to allow for ampacities to be additive per NEC Table 310.16 and 310.17.

Tested to UL 486A/B, UL File E6207

Nimbus 4 Flex Insulated Multi-Tap Connectors



TYPE PBTT

Features

- Accepts building code and fine stranded (flexible) conductor
- UL 486A/B Listed for 600 volts, 90° C/194° F
- Dual rated
- Cold temperature rated to -45° C/-49° F
- High dielectric strength plastisol
- Black cover
- Removable plugs
- Prefilled with De-Ox
- Nimbus Flexible caps are Reflex Blue
- Patented screw design
- Configuration suited to applications with restricted space

Benefits

- Versatility
- Ensures reliability
- For copper, copper flex or aluminum conductor
- Application variability
- Chemical resistant
- UV Rated
- Entry port closure
- Prevents oxides from forming
- Easy identification in the field
- Improves vibration resistance, compresses conductor without damage, eliminates the need for ferrules
- More variability with less space

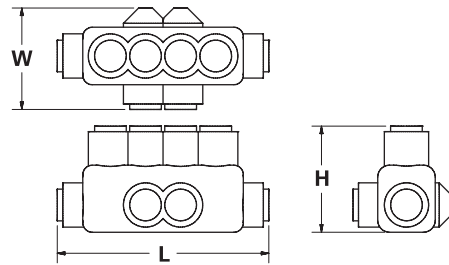

| Catalog Number | No. of Ports* | Wire Range | Alternate Wire Range | Ampere Rating | Dimensions (in.) | | | Hex Size |
|----------------|---------------|------------------|---------------------------------------|---------------|------------------|--------|--------|----------|
| | | | | | L | W | H | |
| PBTT-3-350-F | 3 | 350kcmil-6 AWG | 250-6 H,I,K 4/0-6 M 262.2-6 DLO | 350 | 3.3750 | 2.0310 | 2.4300 | 5/16 |
| PBTT-4-350-F | 4 | 350kcmil-6 AWG | 250-6 H,I,K 4/0-6 M 262.2-6 DLO | 350 | 4.5310 | 2.0300 | 2.4300 | 5/16 |
| PBTT-3-500-F | 3 | 600kcmil-4 AWG | 350-4 H,I,K 4/0-4 M 373.7-4 DLO | 430 | 3.7500 | 2.2500 | 3.0000 | 3/8 |
| PBTT-4-500-F | 4 | 600kcmil-4 AWG | 350-4 H,I,K 4/0-4 M 373.7-4 DLO | 430 | 5.0310 | 2.2500 | 3.0000 | 3/8 |
| PBTT-3-750-F | 3 | 750kcmil-4/0 AWG | 500-3/0 H,I,K 4/0-3/0 M 535.3-3/0 DLO | 535 | 3.7500 | 2.2500 | 3.1800 | 1/2 |
| PBTT-4-750-F | 4 | 750kcmil-4/0 AWG | 500-3/0 H,I,K 4/0-3/0 M 535.3-3/0 DLO | 535 | 5.0310 | 2.2500 | 3.1800 | 1/2 |

All wire sizes, unless noted otherwise, are American Wire Gauge (AWG)

For one input & multiple output configurations, the allowable ampacities per NEC Table 310.16 and 310.17 are as follows: #4-95 Amps, 1/0-170 Amps, 3/0-225 Amps, 250-290 Amps, 350-350 Amps, 600-475 Amps, 750-535 Amps.

For multiple inputs, the inputs must be staggered with outputs to allow for ampacities to be additive per NEC Table 310.16 and 310.17.

Tested to UL 486A/B, UL File E6207

Nimbus 4 Flex Insulated Multi-Tap Connectors



TYPE PBTL

Features

- Accepts building code and fine stranded (flexible) conductor
- UL 486A/B Listed for 600 volts, 90° C/194° F
- Dual rated
- Cold temperature rated to -45° C/-49° F
- High dielectric strength plastisol
- Black cover
- Removable plugs
- Prefilled with De-Ox
- Nimbus Flexible caps are Reflex Blue
- Patented screw design
- Configuration suited to applications with restricted space

Benefits

- Versatility
- Ensures reliability
- For copper, copper flex or aluminum conductor
- Application variability
- Chemical resistant
- UV Rated
- Entry port closure
- Prevents oxides from forming
- Easy identification in the field
- Improves vibration resistance, compresses conductor without damage, eliminates the need for ferrules
- More variability with less space

D

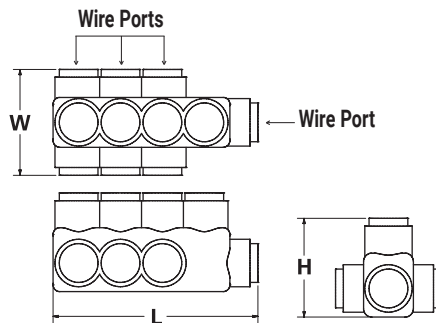

| Catalog Number | No. of Ports* | Wire Range | Alternate Wire Range | Ampere Rating | Dimensions (in.) | | | Hex Size |
|----------------|---------------|------------------|---------------------------------------|---------------|------------------|--------|--------|----------|
| | | | | | L | W | H | |
| PBTL-2-350-F | 2 | 350kcmil-6 AWG | 250-6 H,I,K 4/0-6 M 262.2-6 DLO | 350 | 2.2180 | 2.2500 | 2.4300 | 5/16 |
| PBTL-3-350-F | 3 | 350kcmil-6 AWG | 250-6 H,I,K 4/0-6 M 262.2-6 DLO | 350 | 3.3740 | 2.2500 | 2.4300 | 5/16 |
| PBTL-4-350-F | 4 | 350kcmil-6 AWG | 250-6 H,I,K 4/0-6 M 262.2-6 DLO | 350 | 4.5300 | 2.2500 | 2.4300 | 5/16 |
| PBTL-2-500-F | 2 | 600kcmil-4 AWG | 350-4 H,I,K 4/0-4 M 373.7-4 DLO | 430 | 2.4690 | 2.6250 | 3.0000 | 3/8 |
| PBTL-3-500-F | 3 | 600kcmil-4 AWG | 350-4 H,I,K 4/0-4 M 373.7-4 DLO | 430 | 3.7500 | 2.6250 | 3.0000 | 3/8 |
| PBTL-4-500-F | 4 | 600kcmil-4 AWG | 350-4 H,I,K 4/0-4 M 373.7-4 DLO | 430 | 5.0310 | 2.6250 | 3.0000 | 1/4 |
| PBTL-2-750-F | 2 | 750kcmil-4/0 AWG | 500-3/0 H,I,K 4/0-3/0 M 535.3-3/0 DLO | 535 | 3.0280 | 3.2490 | 3.1800 | 1/2 |
| PBTL-3-750-F | 3 | 750kcmil-4/0 AWG | 500-3/0 H,I,K 4/0-3/0 M 535.3-3/0 DLO | 535 | 4.5880 | 3.2490 | 3.1800 | 1/2 |
| PBTL-4-750-F | 4 | 750kcmil-4/0 AWG | 500-3/0 H,I,K 4/0-3/0 M 535.3-3/0 DLO | 535 | 6.1480 | 3.2490 | 2.4300 | 1/2 |

All wire sizes, unless noted otherwise, are American Wire Gauge (AWG)

For one input & multiple output configurations, the allowable ampacities per NEC Table 310.16 and 310.17 are as follows: #4-95 Amps, 1/0-170 Amps, 3/0-225 Amps, 250-290 Amps, 350-350 Amps, 600-475 Amps, 750-535 Amps.

For multiple inputs, the inputs must be staggered with outputs to allow for ampacities to be additive per NEC Table 310.16 and 310.17.

Tested to UL 486A/B, UL File E6207

Nimbus 4 Flex Insulated Multi-Tap Connectors

RoHS
Compliant

UL
LISTED
453G

SA
LR-29601

TYPE PBTX

Features

- Accepts building code and fine stranded (flexible) conductor
- UL 486A/B Listed for 600 volts, 90° C/194° F
- Dual rated
- Cold temperature rated to -45° C/-49° F
- High dielectric strength plastisol
- Black cover
- Removable plugs
- Prefilled with De-Ox
- Nimbus Flexible caps are Reflex Blue
- Patented screw design
- Configuration suited to applications with restricted space

Benefits

- Versatility
- Ensures reliability
- For copper, copper flex or aluminum conductor
- Application variability
- Chemical resistant
- UV Rated
- Entry port closure
- Prevents oxides from forming
- Easy identification in the field
- Improves vibration resistance, compresses conductor without damage, eliminates the need for ferrules
- More variability with less space

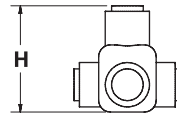
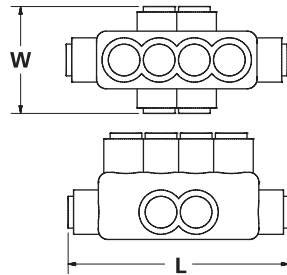

D

| Catalog Number | No. of Ports* | Wire Range | Alternate Wire Range | Ampere Rating | Dimensions (in.) | | | Hex Size |
|----------------|---------------|------------------|---------------------------------------|---------------|------------------|--------|--------|----------|
| | | | | | L | W | H | |
| PBTX-4-350-F | 4 | 350kcmil-6 AWG | 250-6 H,I,K 4/0-6 M 262.2-6 DLO | 350 | 4.5310 | 2.5800 | 2.4300 | 5/16 |
| PBTX-4-500-F | 4 | 600kcmil-4 AWG | 350-4 H,I,K 4/0-4 M 373.7-4 DLO | 430 | 5.0310 | 2.6520 | 3.0000 | 3/8 |
| PBTX-4-750-F | 4 | 750kcmil-4/0 AWG | 500-3/0 H,I,K 4/0-3/0 M 535.3-3/0 DLO | 535 | 6.1480 | 3.2490 | 3.1800 | 1/2 |

All wire sizes, unless noted otherwise, are American Wire Gauge (AWG)

For one input & multiple output configurations, the allowable ampacities per NEC Table 310.16 and 310.17 are as follows: #4-95 Amps, 1/0-170 Amps, 3/0-225 Amps, 250-290 Amps, 350-350 Amps, 600-475 Amps, 750-535 Amps.

For multiple inputs, the inputs must be staggered with outputs to allow for ampacities to be additive per NEC Table 310.16 and 310.17.

Tested to UL 486A/B, UL File E6207

Nimbus 4 Flex Multi-Tap Connectors, Dual Sided Entry



TYPE PBT2

Features

- Fully rated per NEC
- Line side is isolated from load side by wire stop
- Patented screw design
- Broad wire range: 750kcmil-6
- UL 486A/B Listed for 600 volts, 90° C/194° F
- Dual rated
- Cold temperature rated to -45° C/-49° F
- High dielectric strength plastisol
- Prefilled with De-Ox oxide inhibiting compound
- Nimbus 4 Flex caps are Reflex Blue

Benefits

- All wire ports can be used
- Accepts mixed classes of conductor
- Improves vibration resistance, compresses conductor without damage, eliminates the need for ferrules, making it reusable
- Flexibility in the field
- Ensures reliability
- For copper, copper flex or aluminum conductor
- Application variability
- Chemical resistant
- Prevents oxides from forming
- Easy identification in the field

D

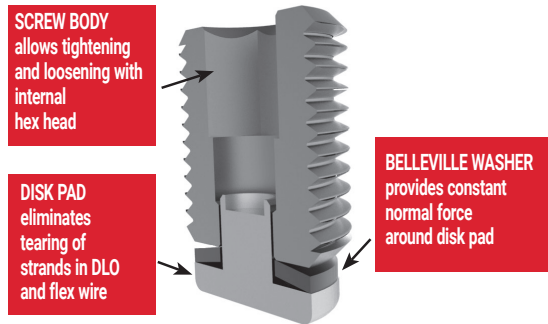
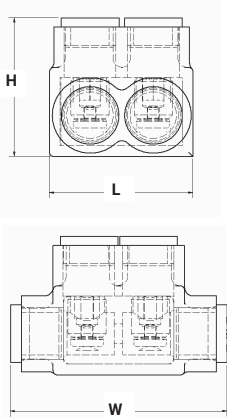

| Catalog Number | No. of Ports* | Wire Range | Alternate Wire Range | Dimensions - in (mm) | | | Hex Size |
|----------------|---------------|---------------------------------------|----------------------|----------------------|---------------|--------------|----------|
| | | | | L | W | H | |
| PBT2-4-250-F | 4 | 4/0-6 H,I,K 2/0-6 M 3/0-6 DLO | 250kcmil-6 | 1.798 (45.7) | 3.188 (81.0) | 2.041 (51.8) | 5/16 |
| PBT2-6-250-F | 6 | 4/0-6 H,I,K 2/0-6 M 3/0-6 DLO | 250kcmil-6 | 2.712 (68.9) | 3.188 (81.0) | 2.041 (51.8) | 5/16 |
| PBT2-8-250-F | 8 | 4/0-6 H,I,K 2/0-6 M 3/0-6 DLO | 250kcmil-6 | 3.642 (92.5) | 3.188 (81.0) | 2.041 (51.8) | 5/16 |
| PBT2-10-250-F | 10 | 4/0-6 H,I,K 2/0-6 M 3/0-6 DLO | 250kcmil-6 | 4.572 (116.1) | 3.188 (81.0) | 2.041 (51.8) | 5/16 |
| PBT2-12-250-F | 12 | 4/0-6 H,I,K 2/0-6 M 3/0-6 DLO | 250kcmil-6 | 5.502 (139.8) | 3.188 (81.0) | 2.041 (51.8) | 5/16 |
| PBT2-4-350-F | 4 | 250-6 H,I,K 4/0-6 M 262.2-6 DLO | 350kcmil-6 | 2.218 (56.3) | 3.708 (94.2) | 2.281 (57.9) | 5/16 |
| PBT2-6-350-F | 6 | 250-6 H,I,K 4/0-6 M 262.2-6 DLO | 350kcmil-6 | 3.374 (85.7) | 3.708 (94.2) | 2.281 (57.9) | 5/16 |
| PBT2-8-350-F | 8 | 250-6 H,I,K 4/0-6 M 262.2-6 DLO | 350kcmil-6 | 4.530 (115.1) | 3.708 (94.2) | 2.281 (57.9) | 5/16 |
| PBT2-10-350-F | 10 | 250-6 H,I,K 4/0-6 M 262.2-6 DLO | 350kcmil-6 | 5.686 (144.4) | 3.708 (94.2) | 2.281 (57.9) | 5/16 |
| PBT2-12-350-F | 12 | 250-6 H,I,K 4/0-6 M 262.2-6 DLO | 350kcmil-6 | 6.842 (173.8) | 3.708 (94.2) | 2.281 (57.9) | 5/16 |
| PBT2-4-600-F | 4 | 350-4 H,I,K 4/0-4 M 373.7-4 DLO | 600kcmil-4 | 2.781 (70.6) | 4.281 (108.7) | 3.034 (77.1) | 3/8 |
| PBT2-6-600-F | 6 | 350-4 H,I,K 4/0-4 M 373.7-4 DLO | 600kcmil-4 | 4.062 (103.2) | 4.281 (108.7) | 3.034 (77.1) | 3/8 |
| PBT2-8-600-F | 8 | 350-4 H,I,K 4/0-4 M 373.7-4 DLO | 600kcmil-4 | 5.343 (135.7) | 4.281 (108.7) | 3.034 (77.1) | 3/8 |
| PBT2-10-600-F | 10 | 350-4 H,I,K 4/0-4 M 373.7-4 DLO | 600kcmil-4 | 6.624 (168.2) | 4.281 (108.7) | 3.034 (77.1) | 3/8 |
| PBT2-12-600-F | 12 | 350-4 H,I,K 4/0-4 M 373.7-4 DLO | 600kcmil-4 | 7.905 (200.8) | 4.281 (108.7) | 3.034 (77.1) | 3/8 |
| PBT2-4-750-F | 4 | 500-3/0 H,I,K 4/0-3/0 M 535.3-3/0 DLO | 750kcmil-4/0 | 3.340 (84.8) | 4.905 (124.6) | 3.206 (81.4) | 1/2 |
| PBT2-6-750-F | 6 | 500-3/0 H,I,K 4/0-3/0 M 535.3-3/0 DLO | 750kcmil-4/0 | 4.900 (124.5) | 4.905 (124.6) | 3.206 (81.4) | 1/2 |
| PBT2-8-750-F | 8 | 500-3/0 H,I,K 4/0-3/0 M 535.3-3/0 DLO | 750kcmil-4/0 | 6.460 (164.1) | 4.905 (124.6) | 3.206 (81.4) | 1/2 |
| PBT2-10-750-F | 10 | 500-3/0 H,I,K 4/0-3/0 M 535.3-3/0 DLO | 750kcmil-4/0 | 8.020 (203.7) | 4.905 (124.6) | 3.206 (81.4) | 1/2 |
| PBT2-12-750-F | 12 | 500-3/0 H,I,K 4/0-3/0 M 535.3-3/0 DLO | 750kcmil-4/0 | 9.580 (243.3) | 4.905 (124.6) | 3.206 (81.4) | 1/2 |

* Contact customer care for additional port configurations

All wire sizes, unless noted otherwise, are American Wire Gauge (AWG)

Fully rated per NEC Article 310-316

Tested to UL 486A/B, UL File E6207

Nimbus 4 Flex Multi-Tap Connectors



TYPE PBTI

Features

- Available with color coded screw caps
- Patented screw design
- Cold temperature rated to -45° C/-49° F
- High dielectric strength plastisol
- Removable plugs
- Prefilled with De-Ox oxide inhibiting compound
- Nimbus 4 Flex wire way caps are Reflex Blue
- UL 486A/B Listed for 600 volts, 90° C/194° F
- Dual rated

Benefits

- Simplifies motor wire-up
- Improves vibration resistance, compresses conductor without damage, eliminates the need for ferrules, making it reusable
- Application variability
- Chemical resistant
- Protect wire way from contamination
- Prevents oxides from forming
- Easy identification in the field
- Ensures reliability
- For copper, copper flex or aluminum conductor

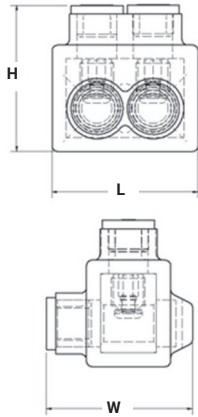

SCREW BODY
allows tightening
and loosening
with
internal
hex head

DISK PAD
eliminates
tearing of
strands in DLO
and flex wire

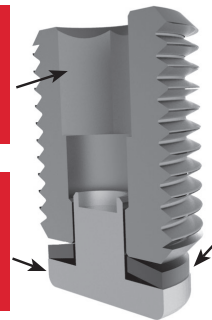

BELLEVILLE WASHER
provides constant
normal force
around disk pad

D

| Catalog Number | No. of Ports | Wire Range | Alternate Wire Range | Dimensions - in (mm) | | | Hex Size |
|----------------|--------------|----------------------|----------------------|----------------------|--------------|--------------|----------|
| | | | | L | W | H | |
| PBTI-2-4-F* | 2 | 8-14 H,I,K,M, DLO | 4-14 AWG | 1.410 (35.8) | 1.257 (31.9) | 1.408 (35.8) | 3/16 |
| PBTI-3-4-F* | 3 | 8-14 H,I,K,M, DLO | 4-14 AWG | 2.035 (51.7) | 1.257 (31.9) | 1.408 (35.8) | 3/16 |
| PBTI-4-4-F* | 4 | 8-14 H,I,K,M, DLO | 4-14 AWG | 2.660 (67.6) | 1.257 (31.9) | 1.408 (35.8) | 3/16 |
| PBTI-5-4-F* | 5 | 8-14 H,I,K,M, DLO | 4-14 AWG | 3.285 (83.4) | 1.257 (31.9) | 1.408 (35.8) | 3/16 |
| PBTI-2-1/0-F* | 2 | 1-14 H,I,K,DLO 2-14M | 1/0-14 AWG | 1.623 (41.2) | 1.625 (41.3) | 1.627 (41.3) | 3/16 |
| PBTI-3-1/0-F* | 3 | 1-14 H,I,K,DLO 2-14M | 1/0-14 AWG | 2.248 (57.1) | 1.625 (41.3) | 1.627 (41.3) | 3/16 |
| PBTI-4-1/0-F* | 4 | 1-14 H,I,K,DLO 2-14M | 1/0-14 AWG | 2.873 (73.0) | 1.625 (41.3) | 1.627 (41.3) | 3/16 |
| PBTI-5-1/0-F* | 5 | 1-14 H,I,K,DLO 2-14M | 1/0-14 AWG | 3.498 (88.8) | 1.625 (41.3) | 1.627 (41.3) | 3/16 |

* Each catalog number must be combined with a color code from Table to determine final catalog number for ordering (i.e. PBTI-2-4-F-*)

All wire sizes, unless noted otherwise, are American Wire Gauge (AWG)

Fully rated per NEC Article 310-316

Tested to UL 486A/B, UL File E6207

| Table | |
|--------|------------|
| Color | Color Code |
| Blue | BLU |
| Red | RED |
| Black | BLK |
| Yellow | YEL |
| Orange | ORG |
| Brown | BRN |
| Green | GRN |
| White | WHT |

Nimbus 4 Flex Multi-Tap Connectors



TYPE PBTfML

Features

- Supplied in preconfigured kits
- Simplifies Megger testing for motors
- Designed for use with fine stranded conductor
- Supplied with color coded screw caps
- Patented screw design
- UL 486A/B Listed for 600 volts, 90° C/194° F
- Dual rated

Benefits

- For specific motor applications, ease of ordering
- Easy disconnect/reconnect without cost of additional materials. No need for electrical tape or wire nuts
- Ideal for motor wiring connections
- Enables user-configurable installations
- Improves vibration resistance, compresses conductor without damage, eliminates the need for ferrules, making it reusable
- Ensures reliability
- For copper, copper flex or aluminum conductor

D

| Catalog Number | Wire Range | Alternate Wire Range | Description | Number of Connectors/ Motor Leads | Wiring Diagram* Fig. No. | Hex Size |
|--------------------|-----------------------|----------------------|-------------------------------------------------------------------------|--------------------------------------|-----------------------------|--------------|
| PBTfML-4-03-WD | 8-14 H,I,K,M, DLO | 4-14 AWG | 3-PHASE 4-14 AWG 3-LEAD WYE OR DELTA | 3 | 1 & 2 | WYE or DELTA |
| PBTfML-4-06-W | 8-14 H,I,K,M, DLO | 4-14 AWG | 3-PHASE 4-14 AWG 6-LEAD WYE CONNECTED MOTOR KIT | 6 | 3 | WYE |
| PBTfML-4-06-D | 8-14 H,I,K,M, DLO | 4-14 AWG | 3-PHASE 4-14 AWG 6-LEAD DELTA CONNECTED MOTOR KIT | 6 | 4 | DELTA |
| PBTfML-4-09-W-L | 8-14 H,I,K,M, DLO | 4-14 AWG | 3-PHASE 4-14 AWG 9-LEAD WYE CONNECTED LOW VOLTAGE MOTOR KIT | 9 | 5 | WYE |
| PBTfML-4-09-D-L | 8-14 H,I,K,M, DLO | 4-14 AWG | 3-PHASE 4-14 AWG 9-LEAD DELTA CONNECTED LOW VOLTAGE MOTOR KIT | 9 | 6 | DELTA |
| PBTfML-4-09-WD-H | 8-14 H,I,K,M, DLO | 4-14 AWG | 3-PHASE 4-14 AWG 9-LEAD WYE OR DELTA CONNECTED HIGH VOLTAGE MOTOR KIT | 9 | 7 & 8 | WYE or DELTA |
| PBTfML-4-12-W-L | 8-14 H,I,K,M, DLO | 4-14 AWG | 3-PHASE 4-14 AWG 12-LEAD WYE CONNECTED LOW VOLTAGE MOTOR KIT | 12 | 9 | WYE |
| PBTfML-4-12-D-L | 8-14 H,I,K,M, DLO | 4-14 AWG | 3-PHASE 4-14 AWG 12-LEAD DELTA CONNECTED LOW VOLTAGE MOTOR KIT | 12 | 10 | DELTA |
| PBTfML-4-12-W-H | 8-14 H,I,K,M, DLO | 4-14 AWG | 3-PHASE 4-14 AWG 12-LEAD WYE CONNECTED HIGH VOLTAGE MOTOR KIT | 12 | 11 | WYE |
| PBTfML-4-12-D-H | 8-14 H,I,K,M, DLO | 4-14 AWG | 3-PHASE 4-14 AWG 12-LEAD DELTA CONNECTED HIGH VOLTAGE MOTOR KIT | 12 | 12 | DELTA |
| PBTfML-1/0-03-WD | 1-14 H,I,K, DLO 2-14M | 1/0-14 AWG | 3-PHASE 1/0-14 AWG 3-LEAD WYE OR DELTA CONNECTED MOTOR KIT | 3 | 1 & 2 | WYE or DELTA |
| PBTfML-1/0-06-W | 1-14 H,I,K, DLO 2-14M | 1/0-14 AWG | 3-PHASE 1/0-14 AWG 6-LEAD WYE CONNECTED MOTOR KIT | 6 | 3 | WYE |
| PBTfML-1/0-06-D | 1-14 H,I,K, DLO 2-14M | 1/0-14 AWG | 3-PHASE 1/0-14 AWG 6-LEAD DELTA CONNECTED MOTOR KIT | 6 | 4 | DELTA |
| PBTfML-1/0-09-W-L | 1-14 H,I,K, DLO 2-14M | 1/0-14 AWG | 3-PHASE 1/0-14 AWG 9-LEAD WYE CONNECTED LOW VOLTAGE MOTOR KIT | 9 | 5 | WYE |
| PBTfML-1/0-09-D-L | 1-14 H,I,K, DLO 2-14M | 1/0-14 AWG | 3-PHASE 1/0-14 AWG 9-LEAD DELTA CONNECTED LOW VOLTAGE MOTOR KIT | 9 | 6 | DELTA |
| PBTfML-1/0-09-WD-H | 1-14 H,I,K, DLO 2-14M | 1/0-14 AWG | 3-PHASE 1/0-14 AWG 9-LEAD WYE OR DELTA CONNECTED HIGH VOLTAGE MOTOR KIT | 9 | 7 & 8 | WYE or DELTA |
| PBTfML-1/0-12-W-L | 1-14 H,I,K, DLO 2-14M | 1/0-14 AWG | 3-PHASE 1/0-14 AWG 12-LEAD WYE CONNECTED LOW VOLTAGE MOTOR KIT | 12 | 9 | WYE |
| PBTfML-1/0-12-D-L | 1-14 H,I,K, DLO 2-14M | 1/0-14 AWG | 3-PHASE 1/0-14 AWG 12-LEAD DELTA CONNECTED LOW VOLTAGE MOTOR KIT | 12 | 10 | DELTA |
| PBTfML-1/0-12-W-H | 1-14 H,I,K, DLO 2-14M | 1/0-14 AWG | 3-PHASE 1/0-14 AWG 12-LEAD WYE CONNECTED HIGH VOLTAGE MOTOR KIT | 12 | 11 | WYE |
| PBTfML-1/0-12-D-H | 1-14 H,I,K, DLO 2-14M | 1/0-14 AWG | 3-PHASE 1/0-14 AWG 12-LEAD DELTA CONNECTED HIGH VOLTAGE MOTOR KIT | 12 | 12 | DELTA |

* Refer to wiring diagram page for details

Common 3-Phase AC Motor Wiring Diagrams

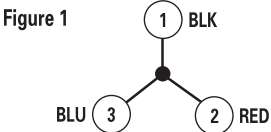
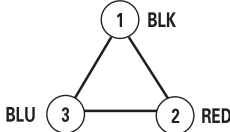
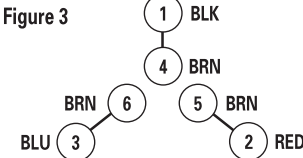
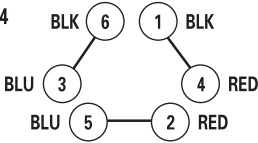
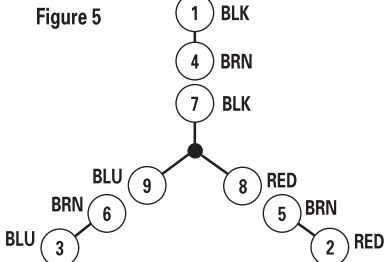
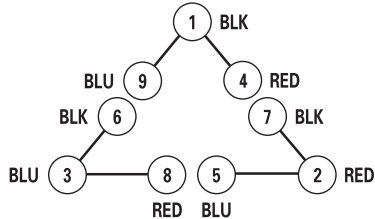
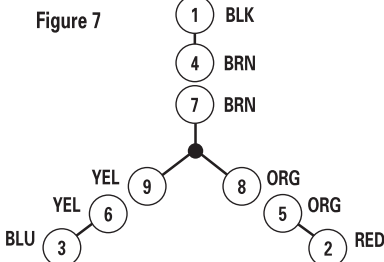
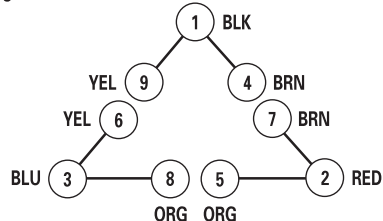
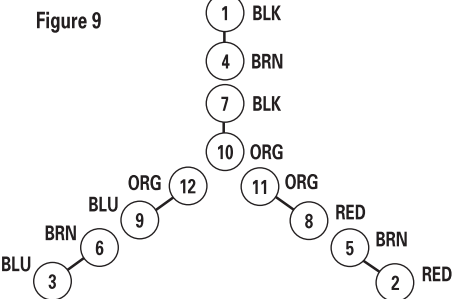
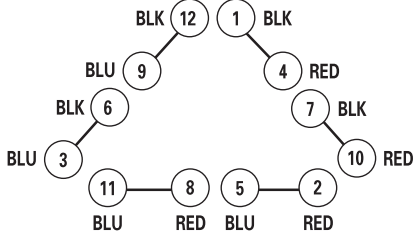
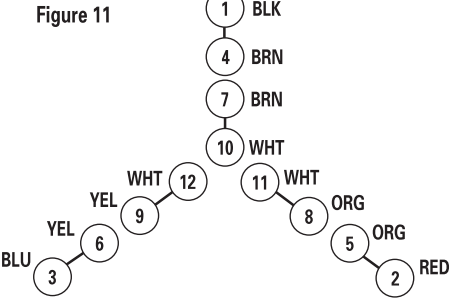
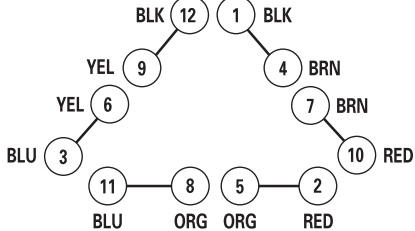
| NEMA Nomenclature | WYE Connected | DELTA Connected |
|-----------------------------------------|------------------------------------------------------------------------------------------------------|--------------------------------------------------------------------------------------------------------|
| 3-Lead Single Voltage Motor | <p>Figure 1</p>  | <p>Figure 2</p>  |
| 6-Lead Single Voltage Motor | <p>Figure 3</p>  | <p>Figure 4</p>  |
| 9-Lead Dual Voltage Motor Low Voltage | <p>Figure 5</p>  | <p>Figure 6</p>  |
| 9-Lead Dual Voltage Motor High Voltage | <p>Figure 7</p>  | <p>Figure 8</p>  |
| 12-Lead Dual Voltage Motor Low Voltage | <p>Figure 9</p>  | <p>Figure 10</p>  |
| 12-Lead Dual Voltage Motor High Voltage | <p>Figure 11</p>  | <p>Figure 12</p>  |

D

Always use wiring diagram supplied on motor nameplate

nVent ILSCO ClearTap

Two Wire In-Line and Offset Insulated Splicer-Reducer Connectors



TYPE ECT

Features

- Broad wire range: 750kcmil-14
- UL Listed and CSA Certified for 600 volts, 90° C/194° F
- Dual rated
- Cold temperature rated to -45° C/-49° F
- High dielectric strength plastisol
- Transparent cover
- Removable plugs
- Prefilled with De-Ox

Benefits

- Flexibility in the field
- Ensures reliability
- For copper or aluminum conductor
- Application variability
- Chemical resistant
- Inspectability
- Entry port closure
- Prevents oxides from forming

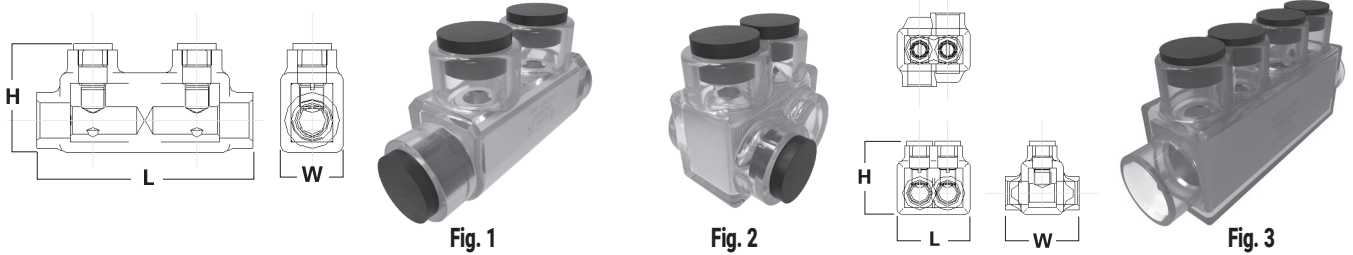

| Catalog Number | Fig. No. | No. of Ports | Conductor Range | Dimensions (in.) | | | Hex Size |
|----------------|----------|--------------|-------------------|------------------|------|------|----------|
| | | | | L | W | H | |
| ECT-1/0 | 1 | - | 1/0-14 | 3.11 | 0.94 | 1.44 | 3/16 |
| ECT-250 | 1 | - | 250kcmil-6 | 4.28 | 1.06 | 2.04 | 5/16 |
| ECT-350 | 1 | - | 350kcmil-6 | 4.75 | 1.31 | 2.43 | 5/16 |
| ECT-500 | 1 | - | 500kcmil-4 | 5.38 | 1.44 | 3.03 | 3/8 |
| ECT-750 | 3 | - | 750kcmil-250kcmil | 7.25 | 1.75 | 3.31 | 3/8 |
| ECTO-4 | 2 | 2 | 4-14 | 1.17 | 1.25 | 1.31 | 1/8 |
| ECTO-1/0 | 2 | 2 | 1/0-14 | 1.63 | 1.63 | 1.63 | 3/16 |
| ECTO-3/0 | 2 | 2 | 3/0-6 | 1.89 | 1.68 | 1.86 | 1/4 |

All wire sizes, unless noted otherwise, are American Wire Gauge (AWG)
 Per NEC Article 310-316, allowable ampacities are as follows: #4-95 Amps, 1/0-170 Amps, 3/0-225 Amps, 250-290 Amps, 350-350 Amps, 500-430 Amps, 750-535 Amps
 Replacement caps & plugs available. Consult Factory
 Tested to UL 486A/B, UL File E6207

ClearTap Insulated Multi-Tap Connectors Single Sided Entry



TYPE ECTS

Features

- Broad wire range: 750kcmil-14
- UL Listed and CSA Certified for 600 volts, 90° C/194° F
- Dual rated
- Cold temperature rated to -45° C/-49° F
- High dielectric strength plastisol
- Transparent cover
- Removable plugs
- Prefilled with De-Ox

Benefits

- Flexibility in the field
- Ensures reliability
- For copper or aluminum conductor
- Application variability
- Chemical resistant
- Inspectability
- Entry port closure
- Prevents oxides from forming

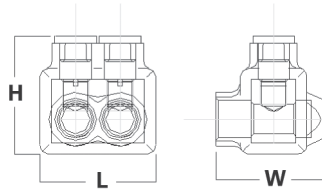

| Catalog Number | No. of Ports | Conductor Range | Dimensions (in.) | | | Hex Size |
|----------------|--------------|-----------------|------------------|-------|-------|----------|
| | | | L | W | H | |
| ECTS-2-4 | 2 | 4-14 | 1.24 | 1.22 | 1.42 | 1/8 |
| ECTS-3-4 | 3 | 4-14 | 1.70 | 1.22 | 1.42 | 1/8 |
| ECTS-4-4 | 4 | 4-14 | 2.16 | 1.22 | 1.42 | 1/8 |
| ECTS-5-4 | 5 | 4-14 | 2.61 | 1.22 | 1.42 | 1/8 |
| ECTS-6-4 | 6 | 4-14 | 3.07 | 1.22 | 1.42 | 1/8 |
| ECTS-7-4 | 7 | 4-14 AWG | 3.458 | 1.32 | 1.379 | 1/8 |
| ECTS-8-4 | 8 | 4-14 AWG | 3.916 | 1.32 | 1.379 | 1/8 |
| ECTS-9-4 | 9 | 4-14 AWG | 4.374 | 1.32 | 1.379 | 1/8 |
| ECTS-10-4 | 10 | 4-14 AWG | 4.832 | 1.32 | 1.379 | 1/8 |
| ECTS-11-4 | 11 | 4-14 AWG | 5.29 | 1.32 | 1.379 | 1/8 |
| ECTS-12-4 | 12 | 4-14 AWG | 5.748 | 1.32 | 1.379 | 1/8 |
| ECTS-13-4 | 13 | 4-14 AWG | 6.206 | 1.32 | 1.379 | 1/8 |
| ECTS-14-4 | 14 | 4-14 AWG | 6.664 | 1.32 | 1.379 | 1/8 |
| ECTS-2-1/0 | 2 | 1/0-14 | 1.67 | 1.53 | 1.63 | 3/16 |
| ECTS-3-1/0 | 3 | 1/0-14 | 2.29 | 1.53 | 1.63 | 3/16 |
| ECTS-4-1/0 | 4 | 1/0-14 | 2.92 | 1.53 | 1.63 | 3/16 |
| ECTS-5-1/0 | 5 | 1/0-14 | 3.54 | 1.53 | 1.63 | 3/16 |
| ECTS-6-1/0 | 6 | 1/0-14 | 4.17 | 1.53 | 1.63 | 3/16 |
| ECTS-7-1/0 | 7 | 1/0-14 AWG | 4.748 | 1.62 | 1.63 | 3/16 |
| ECTS-8-1/0 | 8 | 1/0-14 AWG | 5.373 | 1.62 | 1.63 | 3/16 |
| ECTS-9-1/0 | 9 | 1/0-14 AWG | 5.998 | 1.62 | 1.63 | 3/16 |
| ECTS-10-1/0 | 10 | 1/0-14 AWG | 6.67 | 1.53 | 1.63 | 3/16 |
| ECTS-11-1/0 | 11 | 1/0-14 AWG | 7.248 | 1.62 | 1.63 | 3/16 |
| ECTS-12-1/0 | 12 | 1/0-14 AWG | 7.873 | 1.62 | 1.63 | 3/16 |
| ECTS-13-1/0 | 13 | 1/0-14 AWG | 8.498 | 1.62 | 1.63 | 3/16 |
| ECTS-14-1/0 | 14 | 1/0-14 AWG | 9.123 | 1.53 | 1.63 | 3/16 |
| ECTS-2-3/0 | 2 | 3/0-6 | 1.89 | 1.58 | 1.86 | 1/4 |
| ECTS-3-3/0 | 3 | 3/0-6 | 2.65 | 1.58 | 1.86 | 1/4 |
| ECTS-4-3/0 | 4 | 3/0-6 | 3.42 | 1.58 | 1.86 | 1/4 |
| ECTS-5-3/0 | 5 | 3/0-6 | 4.18 | 1.58 | 1.86 | 1/4 |
| ECTS-6-3/0 | 6 | 3/0-6 | 4.95 | 1.58 | 1.86 | 1/4 |
| ECTS-7-3/0 | 7 | 3/0-6 AWG | 5.71 | 1.726 | 1.86 | 1/4 |
| ECTS-8-3/0 | 8 | 3/0-6 AWG | 6.48 | 1.726 | 1.86 | 1/4 |
| ECTS-9-3/0 | 9 | 3/0-6 AWG | 7.24 | 1.726 | 1.86 | 1/4 |
| ECTS-10-3/0 | 10 | 3/0-6 AWG | 8 | 1.726 | 1.86 | 1/4 |
| ECTS-11-3/0 | 11 | 3/0-6 AWG | 8.77 | 1.726 | 1.86 | 1/4 |
| ECTS-12-3/0 | 12 | 3/0-6 AWG | 9.54 | 1.726 | 1.86 | 1/4 |
| ECTS-13-3/0 | 13 | 3/0-6 AWG | 10.3 | 1.726 | 1.86 | 1/4 |
| ECTS-14-3/0 | 14 | 3/0-6 AWG | 11.07 | 1.726 | 1.86 | 1/4 |

All wire sizes, unless noted otherwise, are American Wire Gauge (AWG)

For one input & multiple output configurations, the allowable ampacities per NEC Table 310.16 and 310.17 are as follows: #4-95 Amps, 1/0-170 Amps, 3/0-225 Amps, 250-290 Amps, 350-350 Amps, 600-475 Amps, 750-535 Amps. For multiple inputs, the inputs must be staggered with outputs to allow for ampacities to be additive per NEC Table 310.16 and 310.17. Replacement caps & plugs available. Consult Factory Tested to UL 486A/B, UL File E6207

D

ClearTap Insulated Multi-Tap Connectors Single Sided Entry



TYPE ECTS

Features

- Broad wire range: 750kcmil-14
- UL Listed and CSA Certified for 600 volts, 90° C/194° F
- Dual rated
- Cold temperature rated to -45° C/-49° F
- High dielectric strength plastisol
- Transparent cover
- Removable plugs
- Prefilled with De-Ox

Benefits

- Flexibility in the field
- Ensures reliability
- For copper or aluminum conductor
- Application variability
- Chemical resistant
- Inspectability
- Entry port closure
- Prevents oxides from forming

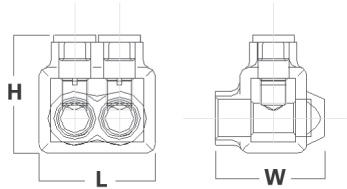

D

| Catalog Number | No. of Ports | Conductor Range | Dimensions (in.) | | | Hex Size |
|----------------|--------------|-----------------|------------------|-------|-------|----------|
| | | | L | W | H | |
| ECTS-2-250 | 2 | 250kcmil-6 | 2.17 | 1.91 | 2.17 | 5/16 |
| ECTS-3-250 | 3 | 250kcmil-6 | 3.07 | 1.91 | 2.17 | 5/16 |
| ECTS-4-250 | 4 | 250kcmil-6 | 3.96 | 1.91 | 2.17 | 5/16 |
| ECTS-5-250 | 5 | 250kcmil-6 | 4.85 | 1.91 | 2.17 | 5/16 |
| ECTS-6-250 | 6 | 250kcmil-6 | 5.75 | 1.91 | 2.17 | 5/16 |
| ECTS-7-250 | 7 | 250 kcmil-6 AWG | 6.744 | 1.94 | 2.041 | 5/16 |
| ECTS-8-250 | 8 | 250 kcmil-6 AWG | 7.674 | 1.94 | 2.041 | 5/16 |
| ECTS-9-250 | 9 | 250 kcmil-6 AWG | 8.604 | 1.94 | 2.041 | 5/16 |
| ECTS-10-250 | 10 | 250 kcmil-6 AWG | 9.534 | 1.94 | 2.041 | 5/16 |
| ECTS-11-250 | 11 | 250 kcmil-6 AWG | 10.464 | 1.94 | 2.041 | 5/16 |
| ECTS-12-250 | 12 | 250 kcmil-6 AWG | 11.394 | 1.94 | 2.041 | 5/16 |
| ECTS-13-250 | 13 | 250 kcmil-6 AWG | 12.334 | 1.94 | 2.041 | 5/16 |
| ECTS-14-250 | 14 | 250 kcmil-6 AWG | 13.254 | 1.94 | 2.041 | 5/16 |
| ECTS-2-350 | 2 | 350kcmil-6 | 2.51 | 2.03 | 2.62 | 5/16 |
| ECTS-3-350 | 3 | 350kcmil-6 | 3.56 | 2.03 | 2.62 | 5/16 |
| ECTS-4-350 | 4 | 350kcmil-6 | 4.61 | 2.03 | 2.62 | 5/16 |
| ECTS-5-350 | 5 | 350kcmil-6 | 5.66 | 2.03 | 2.62 | 5/16 |
| ECTS-6-350 | 6 | 350kcmil-6 | 6.71 | 2.03 | 2.62 | 5/16 |
| ECTS-7-350 | 7 | 350 kcmil-6 AWG | 8.31 | 2.414 | 2.62 | 5/16 |
| ECTS-8-350 | 8 | 350 kcmil-6 AWG | 9.466 | 2.414 | 2.62 | 5/16 |
| ECTS-9-350 | 9 | 350 kcmil-6 AWG | 10.622 | 2.414 | 2.62 | 5/16 |
| ECTS-10-350 | 10 | 350 kcmil-6 AWG | 11.778 | 2.414 | 2.62 | 5/16 |
| ECTS-11-350 | 11 | 350 kcmil-6 AWG | 12.934 | 2.414 | 2.62 | 5/16 |
| ECTS-12-350 | 12 | 350 kcmil-6 AWG | 14.09 | 2.414 | 2.62 | 5/16 |
| ECTS-13-350 | 13 | 350 kcmil-6 AWG | 15.246 | 2.414 | 2.62 | 5/16 |
| ECTS-14-350 | 14 | 350 kcmil-6 AWG | 16.402 | 2.414 | 2.62 | 5/16 |

All wire sizes, unless noted otherwise, are American Wire Gauge (AWG)

For one input & multiple output configurations, the allowable ampacities per NEC Table 310.16 and 310.17 are as follows: #4-95 Amps, 1/0-170 Amps, 3/0-225 Amps, 250-290 Amps, 350-350 Amps, 600-475 Amps, 750-535 Amps.

For multiple inputs, the inputs must be staggered with outputs to allow for ampacities to be additive per NEC Table 310.16 and 310.17.

Replacement caps & plugs available. Consult Factory

Tested to UL 486A/B, UL File E6207

ClearTap Insulated Multi-Tap Connectors Single Sided Entry

RoHS
Compliant

UL
LISTED
453G

SA
LR-29601

TYPE ECTS

Features

- Broad wire range: 750kcmil-14
- UL Listed and CSA Certified for 600 volts, 90° C/194° F
- Dual rated
- Cold temperature rated to -45° C/-49° F
- High dielectric strength plastisol
- Transparent cover
- Removable plugs
- Prefilled with De-Ox

Benefits

- Flexibility in the field
- Ensures reliability
- For copper or aluminum conductor
- Application variability
- Chemical resistant
- Inspectability
- Entry port closure
- Prevents oxides from forming

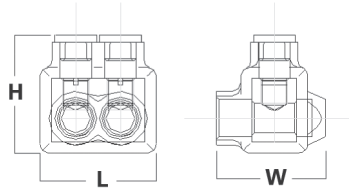

D

| Catalog Number | No. of Ports | Conductor Range | Dimensions (in.) | | | Hex Size |
|----------------|--------------|---------------------|------------------|-------|-------|----------|
| | | | L | W | H | |
| ECTS-2-600 | 2 | 600kcmil-4 | 2.97 | 2.28 | 3.04 | 3/8 |
| ECTS-3-600 | 3 | 600kcmil-4 | 4.12 | 2.58 | 3.04 | 3/8 |
| ECTS-4-600 | 4 | 600kcmil-4 | 5.28 | 2.28 | 3.04 | 3/8 |
| ECTS-5-600 | 5 | 600kcmil-4 | 6.44 | 2.28 | 3.04 | 3/8 |
| ECTS-6-600 | 6 | 600kcmil-4 | 7.59 | 2.28 | 3.04 | 3/8 |
| ECTS-7-600 | 7 | 600 kcmil-4 AWG | 9.186 | 2.484 | 3.034 | 3/8 |
| ECTS-8-600 | 8 | 600 kcmil-4 AWG | 10.467 | 2.484 | 3.034 | 3/8 |
| ECTS-9-600 | 9 | 600 kcmil-4 AWG | 11.748 | 2.484 | 3.034 | 3/8 |
| ECTS-10-600 | 10 | 600 kcmil-4 AWG | 13.029 | 2.484 | 3.034 | 3/8 |
| ECTS-11-600 | 11 | 600 kcmil-4 AWG | 14.31 | 2.484 | 3.034 | 3/8 |
| ECTS-12-600 | 12 | 600 kcmil-4 AWG | 15.591 | 2.484 | 3.034 | 3/8 |
| ECTS-13-600 | 13 | 600 kcmil-4 AWG | 16.872 | 2.484 | 3.034 | 3/8 |
| ECTS-14-600 | 14 | 600 kcmil-4 AWG | 18.153 | 2.484 | 3.034 | 3/8 |
| ECTS-2-750 | 2 | 750kcmil-250kcmil | 3.47 | 2.75 | 3.31 | 1/2 |
| ECTS-3-750 | 3 | 750kcmil-250kcmil | 4.89 | 2.75 | 3.31 | 1/2 |
| ECTS-4-750 | 4 | 750kcmil-250kcmil | 6.32 | 2.75 | 3.31 | 1/2 |
| ECTS-5-750 | 5 | 750kcmil-250kcmil | 7.74 | 2.75 | 3.31 | 1/2 |
| ECTS-6-750 | 6 | 750kcmil-250kcmil | 9.16 | 2.75 | 3.31 | 1/2 |
| ECTS-7-750 | 7 | 750 kcmil-250 kcmil | 11.14 | 2.89 | 3.206 | 1/2 |
| ECTS-8-750 | 8 | 750 kcmil-250 kcmil | 13.7 | 2.89 | 3.206 | 1/2 |
| ECTS-9-750 | 9 | 750 kcmil-250 kcmil | 14.26 | 2.89 | 3.206 | 1/2 |
| ECTS-10-750 | 10 | 750 kcmil-250 kcmil | 15.82 | 2.89 | 3.206 | 1/2 |
| ECTS-11-750 | 11 | 750 kcmil-250 kcmil | 17.38 | 2.89 | 3.206 | 1/2 |
| ECTS-12-750 | 12 | 750 kcmil-250 kcmil | 18.94 | 2.89 | 3.206 | 1/2 |
| ECTS-13-750 | 13 | 750 kcmil-250 kcmil | 20.5 | 2.89 | 3.206 | 1/2 |
| ECTS-14-750 | 14 | 750 kcmil-250 kcmil | 28.06 | 2.89 | 3.206 | 1/2 |

All wire sizes, unless noted otherwise, are American Wire Gauge (AWG)

For one input & multiple output configurations, the allowable ampacities per NEC Table 310.16 and 310.17 are as follows: #4-95 Amps, 1/0-170 Amps, 3/0-225 Amps, 250-290 Amps, 350-350 Amps, 600-475 Amps, 750-535 Amps.

For multiple inputs, the inputs must be staggered with outputs to allow for ampacities to be additive per NEC Table 310.16 and 310.17.

Replacement caps & plugs available. Consult Factory

Tested to UL 486A/B, UL File E6207

ClearTap Insulated Multi-Tap Connectors Dual Sided Entry



TYPE ECTD

Features

- Broad wire range: 750kcmil-14
- UL Listed and CSA Certified for 600 volts, 90° C/194° F
- Dual rated
- Cold temperature rated to -45° C/-49° F
- High dielectric strength plastisol
- Transparent cover
- Removable plugs
- Prefilled with De-Ox

Benefits

- Flexibility in the field
- Ensures reliability
- For copper or aluminum conductor
- Application variability
- Chemical resistant
- Inspectability
- Entry port closure
- Prevents oxides from forming

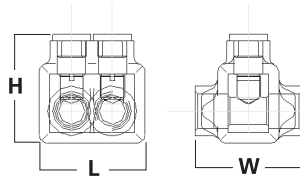

D

| Catalog Number | No. of Ports | Conductor Range | Dimensions (in.) | | | Hex Size |
|----------------|--------------|-----------------|------------------|-------|-------|----------|
| | | | L | W | H | |
| ECTD-2-4 | 2 | 4-14 | 1.24 | 1.25 | 1.42 | 1/8 |
| ECTD-3-4 | 3 | 4-14 | 1.70 | 1.25 | 1.42 | 1/8 |
| ECTD-4-4 | 4 | 4-14 | 2.16 | 1.25 | 1.42 | 1/8 |
| ECTD-5-4 | 5 | 4-14 | 2.61 | 1.25 | 1.42 | 1/8 |
| ECTD-6-4 | 6 | 4-14 | 3.07 | 1.25 | 1.42 | 1/8 |
| ECTD-7-4 | 7 | 4-14 AWG | 3.53 | 1.394 | 1.42 | 1/8 |
| ECTD-8-4 | 8 | 4-14 AWG | 3.99 | 1.394 | 1.42 | 1/8 |
| ECTD-9-4 | 9 | 4-14 AWG | 4.45 | 1.394 | 1.42 | 1/8 |
| ECTD-10-4 | 10 | 4-14 AWG | 4.9 | 1.394 | 1.42 | 1/8 |
| ECTD-11-4 | 11 | 4-14 AWG | 5.36 | 1.394 | 1.42 | 1/8 |
| ECTD-12-4 | 12 | 4-14 AWG | 5.82 | 1.394 | 1.42 | 1/8 |
| ECTD-13-4 | 13 | 4-14 AWG | 6.28 | 1.394 | 1.42 | 1/8 |
| ECTD-14-4 | 14 | 4-14 AWG | 6.74 | 1.394 | 1.42 | 1/8 |
| ECTD-2-1/0 | 2 | 1/0-14 | 1.67 | 1.63 | 1.63 | 3/16 |
| ECTD-3-1/0 | 3 | 1/0-14 | 2.29 | 1.63 | 1.63 | 3/16 |
| ECTD-4-1/0 | 4 | 1/0-14 | 2.92 | 1.63 | 1.63 | 3/16 |
| ECTD-5-1/0 | 5 | 1/0-14 | 3.54 | 1.63 | 1.63 | 3/16 |
| ECTD-6-1/0 | 6 | 1/0-14 | 4.17 | 1.63 | 1.63 | 3/16 |
| ECTD-7-1/0 | 7 | 1/0-14 AWG | 4.748 | 1.825 | 1.63 | 3/16 |
| ECTD-8-1/0 | 8 | 1/0-14 AWG | 5.373 | 1.825 | 1.63 | 3/16 |
| ECTD-9-1/0 | 9 | 1/0-14 AWG | 5.998 | 1.825 | 1.63 | 3/16 |
| ECTD-10-1/0 | 10 | 1/0-14 AWG | 6.623 | 1.825 | 1.63 | 3/16 |
| ECTD-11-1/0 | 11 | 1/0-14 AWG | 7.248 | 1.825 | 1.63 | 3/16 |
| ECTD-12-1/0 | 12 | 1/0-14 AWG | 7.873 | 1.825 | 1.63 | 3/16 |
| ECTD-13-1/0 | 13 | 1/0-14 AWG | 8.498 | 1.825 | 1.63 | 3/16 |
| ECTD-14-1/0 | 14 | 1/0-14 AWG | 9.123 | 1.825 | 1.63 | 3/16 |
| ECTD-2-3/0 | 2 | 3/0-6 | 1.89 | 1.68 | 1.86 | 1/4 |
| ECTD-3-3/0 | 3 | 3/0-6 | 2.65 | 1.68 | 1.86 | 1/4 |
| ECTD-4-3/0 | 4 | 3/0-6 | 3.42 | 1.68 | 1.86 | 1/4 |
| ECTD-5-3/0 | 5 | 3/0-6 | 4.18 | 1.68 | 1.86 | 1/4 |
| ECTD-6-3/0 | 6 | 3/0-6 | 4.95 | 1.68 | 1.86 | 1/4 |
| ECTD-7-3/0 | 7 | 3/0-6 AWG | 5.71 | 2.277 | 2.019 | 1/4 |
| ECTD-8-3/0 | 8 | 3/0-6 AWG | 6.48 | 2.277 | 2.019 | 1/4 |
| ECTD-9-3/0 | 9 | 3/0-6 AWG | 7.24 | 2.277 | 2.019 | 1/4 |
| ECTD-10-3/0 | 10 | 3/0-6 AWG | 8.01 | 2.277 | 2.019 | 1/4 |
| ECTD-11-3/0 | 11 | 3/0-6 AWG | 8.77 | 2.277 | 2.019 | 1/4 |
| ECTD-12-3/0 | 12 | 3/0-6 AWG | 9.54 | 2.277 | 2.019 | 1/4 |
| ECTD-13-3/0 | 13 | 3/0-6 AWG | 10.3 | 2.277 | 2.019 | 1/4 |
| ECTD-14-3/0 | 14 | 3/0-6 AWG | 11.07 | 2.277 | 2.019 | 1/4 |

All wire sizes, unless noted otherwise, are American Wire Gauge (AWG)

For one input & multiple output configurations, the allowable ampacities per NEC Table 310.16 and 310.17 are as follows: #4-95 Amps, 1/0-170 Amps, 3/0-225 Amps, 250-290 Amps, 350-350 Amps, 600-475 Amps, 750-535 Amps. For multiple inputs, the inputs must be staggered with outputs to allow for ampacities to be additive per NEC Table 310.16 and 310.17.

Replacement caps & plugs available. Consult Factory Tested to UL 486A/B, UL File E6207

ClearTap Insulated Multi-Tap Connectors Dual Sided Entry



TYPE ECTD

Features

- Broad wire range: 750kcmil-14
- UL Listed and CSA Certified for 600 volts, 90° C/194° F
- Dual rated
- Cold temperature rated to -45° C/-49° F
- High dielectric strength plastisol
- Transparent cover
- Removable plugs
- Prefilled with De-Ox

Benefits

- Flexibility in the field
- Ensures reliability
- For copper or aluminum conductor
- Application variability
- Chemical resistant
- Inspectability
- Entry port closure
- Prevents oxides from forming

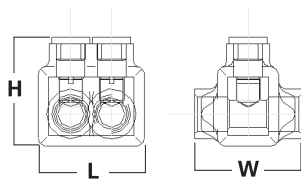

| Catalog Number | No. of Ports | Conductor Range | Dimensions (in.) | | | Hex Size |
|----------------|--------------|-----------------|------------------|-------|-------|----------|
| | | | L | W | H | |
| ECTD-2-250 | 2 | 250kcmil-6 | 2.17 | 2.13 | 2.17 | 5/16 |
| ECTD-3-250 | 3 | 250kcmil-6 | 3.07 | 2.13 | 2.17 | 5/16 |
| ECTD-4-250 | 4 | 250kcmil-6 | 3.96 | 2.13 | 2.17 | 5/16 |
| ECTD-5-250 | 5 | 250kcmil-6 | 4.85 | 2.13 | 2.17 | 5/16 |
| ECTD-6-250 | 6 | 250kcmil-6 | 5.75 | 2.13 | 2.17 | 5/16 |
| ECTD-7-250 | 7 | 250 kcmil-6 AWG | 6.76 | 2.318 | 2.041 | 5/16 |
| ECTD-8-250 | 8 | 250 kcmil-6 AWG | 7.69 | 2.318 | 2.041 | 5/16 |
| ECTD-9-250 | 9 | 250 kcmil-6 AWG | 8.62 | 2.318 | 2.041 | 5/16 |
| ECTD-10-250 | 10 | 250 kcmil-6 AWG | 9.55 | 2.318 | 2.041 | 5/16 |
| ECTD-11-250 | 11 | 250 kcmil-6 AWG | 10.48 | 2.318 | 2.041 | 5/16 |
| ECTD-12-250 | 12 | 250 kcmil-6 AWG | 11.41 | 2.318 | 2.041 | 5/16 |
| ECTD-13-250 | 13 | 250 kcmil-6 AWG | 12.34 | 2.318 | 2.041 | 5/16 |
| ECTD-14-250 | 14 | 250 kcmil-6 AWG | 14.27 | 2.318 | 2.041 | 5/16 |
| ECTD-2-350 | 2 | 350kcmil-6 | 2.51 | 2.25 | 2.62 | 5/16 |
| ECTD-3-350 | 3 | 350kcmil-6 | 3.56 | 2.25 | 2.62 | 5/16 |
| ECTD-4-350 | 4 | 350kcmil-6 | 4.61 | 2.25 | 2.62 | 5/16 |
| ECTD-5-350 | 5 | 350kcmil-6 | 5.67 | 2.25 | 2.62 | 5/16 |
| ECTD-6-350 | 6 | 350kcmil-6 | 6.71 | 2.25 | 2.62 | 5/16 |
| ECTD-7-350 | 7 | 350 kcmil-6 AWG | 8.248 | 2.578 | 2.396 | 5/16 |
| ECTD-8-350 | 8 | 350 kcmil-6 AWG | 9.404 | 2.578 | 2.396 | 5/16 |
| ECTD-9-350 | 9 | 350 kcmil-6 AWG | 10.56 | 2.578 | 2.396 | 5/16 |
| ECTD-10-350 | 10 | 350 kcmil-6 AWG | 11.716 | 2.578 | 2.396 | 5/16 |
| ECTD-11-350 | 11 | 350 kcmil-6 AWG | 12.872 | 2.578 | 2.396 | 5/16 |
| ECTD-12-350 | 12 | 350 kcmil-6 AWG | 14.028 | 2.578 | 2.396 | 5/16 |
| ECTD-13-350 | 13 | 350 kcmil-6 AWG | 15.184 | 2.578 | 2.396 | 5/16 |
| ECTD-14-350 | 14 | 350 kcmil-6 AWG | 16.34 | 2.578 | 2.396 | 5/16 |

All wire sizes, unless noted otherwise, are American Wire Gauge (AWG)

For one input & multiple output configurations, the allowable ampacities per NEC Table 310.16 and 310.17 are as follows: #4-95 Amps, 1/0-170 Amps, 3/0-225 Amps, 250-290 Amps, 350-350 Amps, 600-475 Amps, 750-535 Amps.

For multiple inputs, the inputs must be staggered with outputs to allow for ampacities to be additive per NEC Table 310.16 and 310.17.

Replacement caps & plugs available. Consult Factory

Tested to UL 486A/B, UL File E6207

D

ClearTap Insulated Multi-Tap Connectors Dual Sided Entry

RoHS
Compliant

UL
LISTED
453G

SA
LR-29601

TYPE ECTD

Features

- Broad wire range: 750kcmil-14
- UL Listed and CSA Certified for 600 volts, 90° C/194° F
- Dual rated
- Cold temperature rated to -45° C/-49° F
- High dielectric strength plastisol
- Transparent cover
- Removable plugs
- Prefilled with De-Ox

Benefits

- Flexibility in the field
- Ensures reliability
- For copper or aluminum conductor
- Application variability
- Chemical resistant
- Inspectability
- Entry port closure
- Prevents oxides from forming

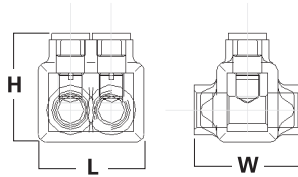

D

| Catalog Number | No. of Ports | Conductor Range | Dimensions (in.) | | | Hex Size |
|----------------|--------------|---------------------|------------------|-------|-------|----------|
| | | | L | W | H | |
| ECTD-2-600 | 2 | 600kcmil-4 | 2.97 | 2.63 | 3.04 | 3/8 |
| ECTD-3-600 | 3 | 600kcmil-4 | 4.12 | 2.63 | 3.04 | 3/8 |
| ECTD-4-600 | 4 | 600kcmil-4 | 5.28 | 2.63 | 3.04 | 3/8 |
| ECTD-5-600 | 5 | 600kcmil-4 | 6.44 | 2.63 | 3.04 | 3/8 |
| ECTD-6-600 | 6 | 600kcmil-4 | 7.59 | 2.63 | 3.04 | 3/8 |
| ECTD-7-600 | 7 | 600 kcmil-4 AWG | 9.186 | 3.036 | 3.034 | 3/8 |
| ECTD-8-600 | 8 | 600 kcmil-4 AWG | 10.467 | 3.031 | 3.034 | 3/8 |
| ECTD-9-600 | 9 | 600 kcmil-4 AWG | 11.748 | 3.031 | 3.034 | 3/8 |
| ECTD-10-600 | 10 | 600 kcmil-4 AWG | 13.029 | 3.031 | 3.034 | 3/8 |
| ECTD-11-600 | 11 | 600 kcmil-4 AWG | 14.31 | 3.031 | 3.034 | 3/8 |
| ECTD-12-600 | 12 | 600 kcmil-4 AWG | 15.591 | 3.031 | 3.034 | 3/8 |
| ECTD-13-600 | 13 | 600 kcmil-4 AWG | 16.872 | 3.031 | 3.034 | 3/8 |
| ECTD-14-600 | 14 | 600 kcmil-4 AWG | 18.153 | 3.031 | 3.034 | 3/8 |
| ECTD-2-750 | 2 | 750kcmil-250kcmil | 3.47 | 3.25 | 3.31 | 1/2 |
| ECTD-3-750 | 3 | 750kcmil-250kcmil | 4.89 | 3.25 | 3.31 | 1/2 |
| ECTD-4-750 | 4 | 750kcmil-250kcmil | 6.32 | 3.25 | 3.31 | 1/2 |
| ECTD-5-750 | 5 | 750kcmil-250kcmil | 7.74 | 3.25 | 3.31 | 1/2 |
| ECTD-6-750 | 6 | 750kcmil-250kcmil | 9.16 | 3.25 | 3.31 | 1/2 |
| ECTD-7-750 | 7 | 750 kcmil-250 kcmil | 11.14 | 3.405 | 3.206 | 1/2 |
| ECTD-8-750 | 8 | 750 kcmil-250 kcmil | 12.7 | 3.405 | 3.206 | 1/2 |
| ECTD-9-750 | 9 | 750 kcmil-250 kcmil | 14.26 | 3.405 | 3.206 | 1/2 |
| ECTD-10-750 | 10 | 750 kcmil-250 kcmil | 15.82 | 3.405 | 3.206 | 1/2 |
| ECTD-11-750 | 11 | 750 kcmil-250 kcmil | 17.38 | 3.405 | 3.206 | 1/2 |
| ECTD-12-750 | 12 | 750 kcmil-250 kcmil | 18.94 | 3.405 | 3.206 | 1/2 |
| ECTD-13-750 | 13 | 750 kcmil-250 kcmil | 20.5 | 3.405 | 3.206 | 1/2 |
| ECTD-14-750 | 14 | 750 kcmil-250 kcmil | 22.06 | 3.405 | 3.206 | 1/2 |

All wire sizes, unless noted otherwise, are American Wire Gauge (AWG)

For one input & multiple output configurations, the allowable ampacities per NEC Table 310.16 and 310.17 are as follows: #4-95 Amps, 1/0-170 Amps, 3/0-225 Amps, 250-290 Amps, 350-350 Amps, 600-475 Amps, 750-535 Amps.

For multiple inputs, the inputs must be staggered with outputs to allow for ampacities to be additive per NEC Table 310.16 and 310.17.

Replacement caps & plugs available. Consult Factory

Tested to UL 486A/B, UL File E6207

ClearTap Insulated Multi-Tap Connectors Dual Sided Entry



TYPE ECTD

Features

- Broad wire range: 250kcmil-6
- UL Listed and CSA Certified for 600 volts, 90° C/194° F
- Dual rated (Single conductor per wire port)
- Cold temperature rated to -45° C/-49° F
- High dielectric strength plastisol
- Transparent cover
- Removable plugs
- Prefilled with De-Ox

Benefits

- Flexibility in the field
- Ensures reliability
- For copper or aluminum conductor
- Application variability
- Chemical resistant
- Inspectability
- Entry port closure
- Prevents oxides from forming

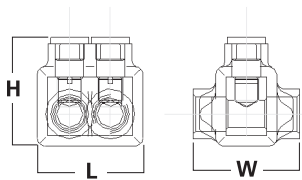

| Catalog Number | No. of Ports | Conductor Range | Dimensions (in.) | | | Hex Size |
|----------------|--------------|-----------------|------------------|-------|-------|----------|
| | | | L | W | H | |
| ECTD-3-250-SR | 3 | 250 kcmil-6 AWG | 3.07 | 2.13 | 2.17 | 5/16 |
| ECTD-4-250-SR | 4 | 250 kcmil-6 AWG | 3.96 | 2.13 | 2.17 | 5/16 |
| ECTD-5-250-SR | 5 | 250 kcmil-6 AWG | 4.85 | 2.13 | 2.17 | 5/16 |
| ECTD-6-250-SR | 6 | 250 kcmil-6 AWG | 5.75 | 2.13 | 2.17 | 5/16 |
| ECTD-7-250-SR | 7 | 250 kcmil-6 AWG | 6.76 | 2.318 | 2.041 | 5/16 |
| ECTD-8-250-SR | 8 | 250 kcmil-6 AWG | 7.69 | 2.318 | 2.041 | 5/16 |
| ECTD-9-250-SR | 9 | 250 kcmil-6 AWG | 8.62 | 2.318 | 2.041 | 5/16 |
| ECTD-10-250-SR | 10 | 250 kcmil-6 AWG | 9.55 | 2.318 | 2.041 | 5/16 |
| ECTD-11-250-SR | 11 | 250 kcmil-6 AWG | 10.48 | 2.318 | 2.041 | 5/16 |
| ECTD-12-250-SR | 12 | 250 kcmil-6 AWG | 11.41 | 2.318 | 2.041 | 5/16 |
| ECTD-13-250-SR | 13 | 250 kcmil-6 AWG | 12.34 | 2.318 | 2.041 | 5/16 |
| ECTD-14-250-SR | 14 | 250 kcmil-6 AWG | 14.27 | 2.318 | 2.041 | 5/16 |

All wire sizes, unless noted otherwise, are American Wire Gauge (AWG)

For one input & multiple output configurations, the allowable ampacities per NEC Table 310.16 and 310.17 are as follows: #4-95 Amps, 1/0-170 Amps, 3/0-225 Amps, 250-290 Amps, 350-350 Amps, 600-475 Amps, 750-535 Amps.

For multiple inputs, the inputs must be staggered with outputs to allow for ampacities to be additive per NEC Table 310.16 and 310.17.

Replacement caps & plugs available. Consult Factory

Tested to UL 486A/B, UL File E6207

**Suitable for use on the line side of the service equipment
Compliant with NEC 230.46**

D

ClearTap Insulated Multi-Tap Connectors

RoHS
Compliant

UL
LISTED
453G

SA
LR-29601

TYPE PCT

Features

- Transparent flexible insulating cover
- Captive pressure screws
- Self-closing openings
- Access from both sides of connector
- Broad wire range: 800kcmil-14
- UL Listed for 600 volts, 90° C/194° F
- Dual Rated

Benefits

- No taping and allows visual inspection of connection
- No wasted time finding screws
- No lost or loose caps and plugs
- Provides greater versatility
- Reduces inventory
- Ensures reliability
- For copper or aluminum conductor

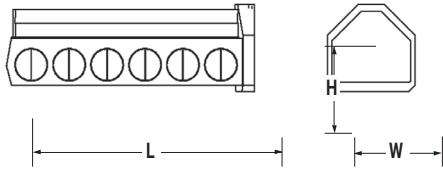

D

| Catalog Number | No. of Ports | Wire Range | Ampere Rating | Dimensions (in.) | | | Hex Size |
|----------------|--------------|-------------------|---------------|------------------|------|------|----------|
| | | | | L | W | H | |
| PCT-2-2/0 | 2 | 2/0-14 | 195 | 2.61 | 2.30 | 1.97 | 3/16 |
| PCT-4-2/0 | 4 | 2/0-14 | 195 | 4.30 | 2.30 | 1.97 | 3/16 |
| PCT-6-2/0 | 6 | 2/0-14 | 195 | 5.98 | 2.30 | 1.97 | 3/16 |
| PCT-8-2/0 | 8 | 2/0-14 | 195 | 7.67 | 2.30 | 1.97 | 3/16 |
| PCT-2-4/0 | 2 | 4/0-6 | 260 | 2.33 | 2.49 | 2.25 | 5/16 |
| PCT-4-4/0 | 4 | 4/0-6 | 260 | 4.19 | 2.49 | 2.25 | 5/16 |
| PCT-6-4/0 | 6 | 4/0-6 | 260 | 6.05 | 2.49 | 2.25 | 5/16 |
| PCT-8-4/0 | 8 | 4/0-6 | 260 | 7.91 | 2.49 | 2.25 | 5/16 |
| PCT-2-350 | 2 | 350 kcmil-6 | 350 | 2.75 | 2.69 | 2.65 | 5/16 |
| PCT-4-350 | 4 | 350 kcmil-6 | 350 | 5.06 | 2.69 | 2.65 | 5/16 |
| PCT-6-350 | 6 | 350 kcmil-6 | 350 | 7.37 | 2.69 | 2.65 | 5/16 |
| PCT-8-350 | 8 | 350 kcmil-6 | 350 | 9.68 | 2.69 | 2.65 | 5/16 |
| PCT-2-600 | 2 | 600 kcmil-4 | 475 | 3.17 | 3.20 | 3.27 | 3/8 |
| PCT-4-600 | 4 | 600 kcmil-4 | 475 | 5.73 | 3.20 | 3.27 | 3/8 |
| PCT-6-600 | 6 | 600 kcmil-4 | 475 | 8.29 | 3.20 | 3.27 | 3/8 |
| PCT-8-600 | 8 | 600 kcmil-4 | 475 | 10.86 | 3.20 | 3.27 | 3/8 |
| PCT-2-800 | 2 | 800kcmil-250kcmil | 555 | 3.91 | 3.34 | 3.30 | 1/2 |
| PCT-4-800 | 4 | 800kcmil-250kcmil | 555 | 7.03 | 3.34 | 3.30 | 1/2 |
| PCT-6-800 | 6 | 800kcmil-250kcmil | 555 | 10.15 | 3.34 | 3.30 | 1/2 |

All wire sizes, unless noted otherwise, are American Wire Gauge (AWG)
Not suitable for direct burial.
Tested to UL 486A/B, UL File E6207

nVent ILSCO RocketSplice Insulated Splicer-Reducer Connector

RoHS
Compliant

UL
LISTED
453G

SA
LR-29601

TYPE SPAR

Features

- Transparent flexible insulating cover
- Range adjustable trim-to-fit tip
- Unique shape and compact design
- Connector, cover and cable tie packaged together
- UL Listed and CSA Certified for 600 volts
- Dual Rated

Benefits

- No taping and allows visual inspection of splice
- Ensures proper fit of cover to cable
- Provides ease of installation, versatility and serviceability of connections made in tight spaces
- Provides ease of ordering
- Ensures reliability
- Use with copper or aluminum conductor

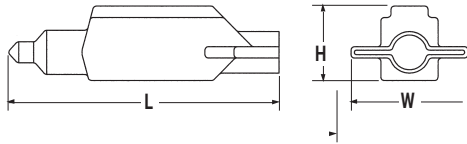

D

| Catalog Number | Wire Range | Dimensions (in.) | | | Screw Size & Shape |
|----------------|-------------|------------------|------|------|---------------------|
| | | L | W | H | |
| SPAR-4 | 4-14 | 3.30 | 1.55 | .76 | slotted |
| SPAR-2 | 2-14 | 3.83 | 1.75 | .95 | slotted |
| SPAR-1/0 | 1/0-14 | 4.80 | 1.94 | 1.14 | 3/16 in socket head |
| SPAR-250 | 250kcmil-6 | 5.67 | 2.41 | 1.29 | 5/16 in socket head |
| SPAR-350 | 350kcmil-10 | 6.17 | 3.29 | 1.79 | 5/16 in socket head |
| SPAR-500 | 500kcmil-4 | 7.94 | 3.66 | 2.28 | 3/8 in socket head |

nVent ILSCO MAC Block Multi-Wire Tap and Splice

For Adding Branch Connections and Light Industrial Applications



TYPE MAC

Features

- Dual rated
- Set screw connections
- IP20 touch safe protection
- Multiple conductor sizes per port
- Eliminates pigtails
- Accepts flex conductors
- Certified for power and grounding
- Connector rated to 90° C/194° F, 300 volts
- Insulated cover rated to 105° C/221° F
- Runs 35° F/1° C cooler than leading twist-on connectors
- Secureness strength 2.5 times higher than leading twist-ons

Benefits

- For copper or aluminum conductor
- More secure and reliable than twist on connectors
- Minimizes risk of electrical shock
- Can mix various sizes, e.g. 1 #18 & 1#12
- Up to 4 #14 AWG conductors per port
- For motors and commercial applications
- Application versatility
- Ensures reliability

D

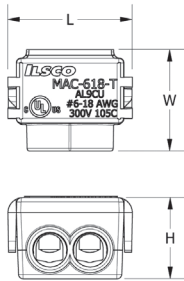

Fig. 1

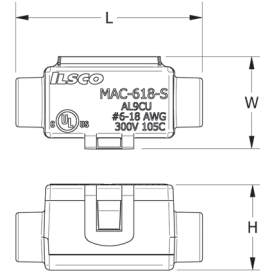

Fig. 2

| Catalog Number | MAC Block | | | | | Overall Dimensions - in. (mm) | | |
|----------------|-----------|----------|--------------------|--------------------|----------------------|-------------------------------|--------------|--------------|
| | Color | Fig. No. | CU Conductor Range | AL Conductor Range | Flex Conductor Range | W | H | L |
| MAC-618-T-K | Black | 1 | #6-#18 | #6-#12 | #6-#14 | 0.84 (21.3) | 0.689 (17.5) | 1.04 (26.4) |
| MAC-618-S-K | Black | 2 | #6-#18 | #6-#12 | #6-#14 | 0.7 (17.8) | 0.689 (17.5) | 1.488 (37.8) |

All wire sizes, unless noted otherwise, are American Wire Gauge
 Dissimilar conductor materials cannot be used in the same port
 Tested to UL 486A/B, UL File E6207
 Tested to UL 467, UL File E6207

nVent ILSCO KUP-L-TAP Insulation Piercing Connectors Save Time And Money

Tin plated, hardened copper contact teeth easily penetrate most types of conductor insulation.

Bolt tightens with just a wrench. Available in stainless steel for corrosive environments.

KUP-L-TAP is dual-rated for copper and aluminum conductors.

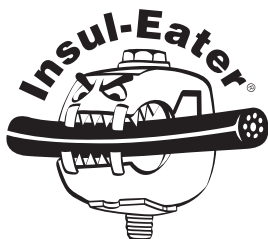
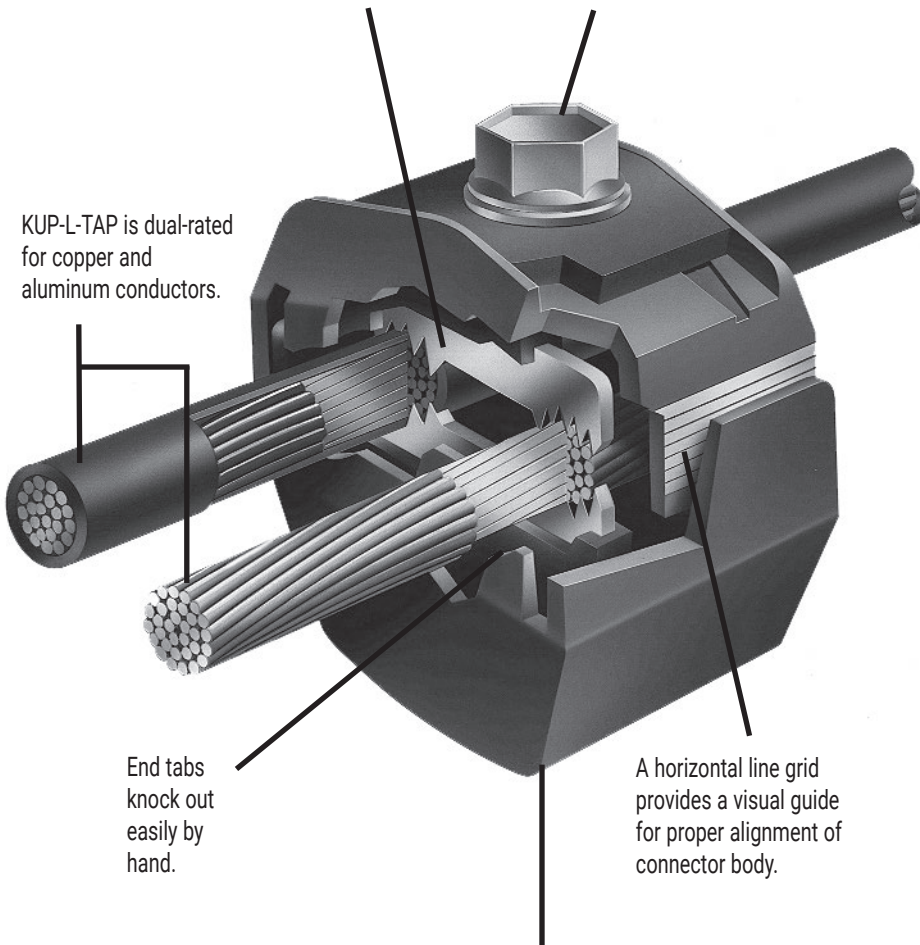

KUP-L-TAP body is molded of tough, resilient glass-filled nylon. Silicone compound acts as a blocking agent to protect connection from oxidation

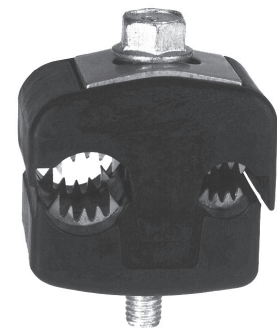

KUP-L-TAP

Insulation Piercing Connectors

Dual Rated



TYPE IPC



Features

- Body is molded from tough, resilient glass-filled nylon
- Compact design
- Tin plated copper contact teeth
- Insulation piercing
- Perforated end tabs
- Pre-filled with silicone lubricant
- Versatile
- Increased safety
- Horizontal line grid
- Temperature rating 90° C/194° F

Benefits

- Provides high degree of breakage resistance and long dependable use
- Saves space
- Easily penetrates most types of insulation
- No need to strip the conductor which saves installation time
- Break out easily by hand
- Prevents oxidation and moisture from entering the contact area
- Can be used as a splice or tap connector
- Contains no external energized parts. Can be installed "hot" on energized conductors providing tap conductor is not under load.
- Provides a visual guide for proper installation of conductors

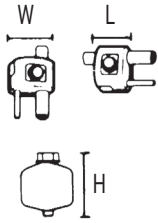

Fig. 1



Fig. 2

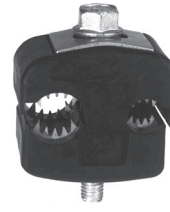

Fig. 3



Fig. 4

E

| Catalog Number | Figure Number | Wire Range | | Volts | Current Rating | | Dimensions (in.) | | | Torque Ft. Lbs. | Bolt Head Size |
|----------------|---------------|---------------------|-------------------|-----------------------------|----------------|-----|------------------|---------|---------|-----------------|----------------|
| | | Main | Tap | | CU | AL | L | W | H | | |
| IPC-1/0-2 | 3 | 1/0-8 | 2-8 | 300 (480 Grounded Y System) | 130 | 100 | 1-7/32 | 1-15/32 | 2-5/16 | 16 | 1/2 |
| IPC-4/0-6 | 2 | 4/0-4 | 6-14 | 600 | 75 | 60 | 1-27/64 | 1 | 1-7/8 | 13 | 1/2 |
| IPC-4/0-2/0 | 3 | 4/0-2 | 2/0-6 | 600 | 195 | 150 | 1-21/32 | 1-7/8 | 2-7/8 | 25 | 1/2 |
| ipc-250-4/0 | 2 | 250kcmil - 1 | 4/0-6 | 600 | 260 | 205 | 1-7/8 | 2-11/32 | 3-11/32 | 30 | 5/8 |
| ipc-350-4/0 | 3 | 350kcmil - 4/0 | 4/0-10 | 300 (480 Grounded Y System) | 260 | 205 | 1-43/64 | 2-7/16 | 3-1/8 | 25 | 5/8 |
| ipc-350-350 | 4 | 350kcmil - 4/0 | 350kcmil-4/0 | 300 (480 Grounded Y System) | 350 | 280 | 2-43/64 | 2-23/32 | 3-1/4 | 25 | 5/8 |
| ipc-500-12 | 1 | 500kcmil - 250kcmil | 10-12 | 300 (480 Grounded Y System) | 40 | 35 | 1-43/64 | 2-7/16 | 3-1/4 | 25 | 5/8 |
| ipc-500-250 | 1 | 500kcmil - 250kcmil | 250kcmil-4 | 600 | 290 | 230 | 2-27/64 | 2-29/32 | 3-3/4 | 60 | 5/8-11/16 |
| ipc-500-500 | 1 | 500kcmil - 300kcmil | 500kcmil-250kcmil | 600 | 430 | 350 | 3-3/16 | 3-5/8 | 5 | 75 | 7/8-7/8 |
| ipc-750-500 | 1 | 750kcmil - 500kcmil | 500kcmil-350kcmil | 600 | 430 | 350 | 3-3/16 | 3-5/8 | 5 | 75 | 7/8-7/8 |

All wire sizes, unless noted otherwise, are American Wire Gauge (AWG)
Tested to UL 486A/B, UL File E6207

Not for use with cloth insulated conductor type TCCW

Power Distribution Blocks

PDH

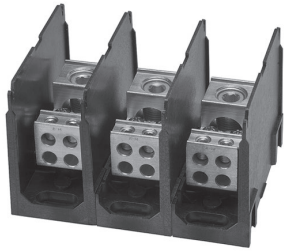

245 - 246

PDE

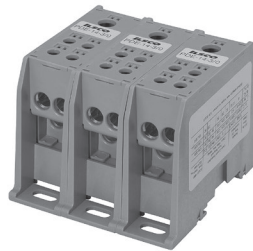

247

PDL



248

PDS

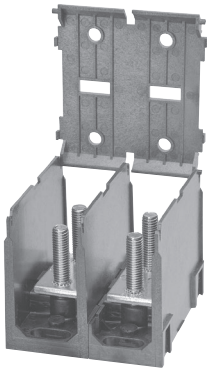

249 - 250

PDM

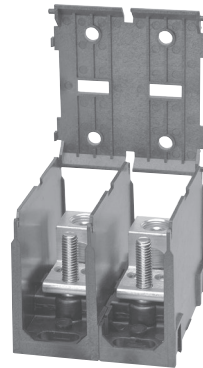

251 - 252

LDAU/LDBU

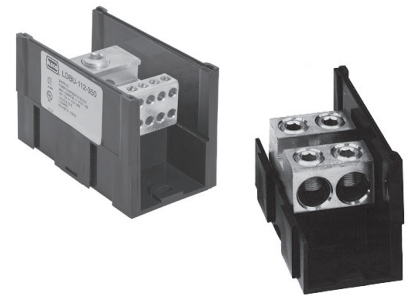

253

PDBU

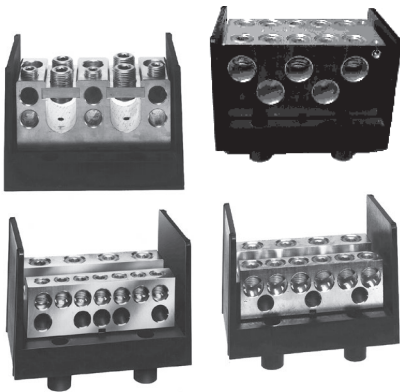

254 - 256

LDA/LDB

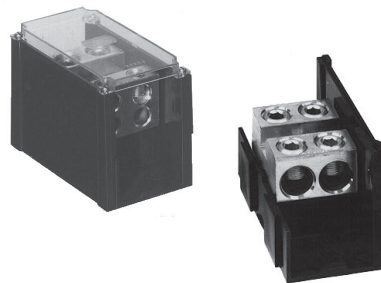

257

Snapbloc

PDA/PDC



258

PDB

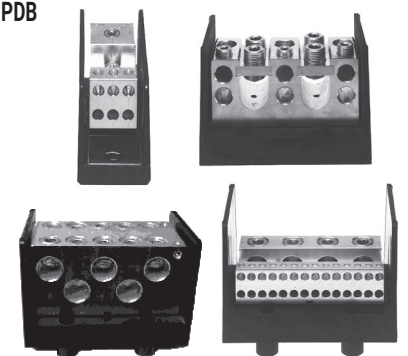

259 - 264

Power Distribution Block

High Short-Circuit Current Rating

RoHS
Compliant



TYPE
PDH

Features

- Manufactured from high strength aluminum
- UL 1059 Recognized 90° C/194° F 600 Volts and CSA Certified
- Electro-tin plated
- High Short Circuit Rating 100K RMS SYM Amps
- For use with building code or flexible conductor

Benefits

- Suitable for use with either copper or aluminum conductors
- Ensures reliability
- Provides low contact resistance
- Added protection

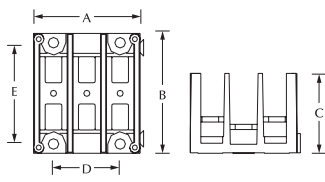
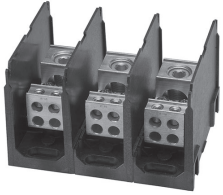

Fig. 1

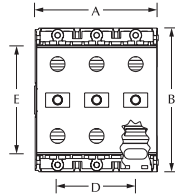

Fig. 2

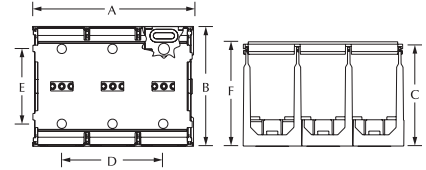

Fig. 3

| Catalog Number | Figure No. | Amps | Rated Conductor Range | | High SCCR Conditions | | | | | | | | SCCR RMS SYM Amps | Volts Max | Dimensions (in.) | | | | | | DCover ID |
|----------------|------------|------|------------------------------------|------------|------------------------------|-----------------------|------------------------------------------------------------|------|-----|-----|-----|-----|-------------------|-----------|------------------|------|------|------|------|-----------|-----------|
| | | | | | Suitable Conductors Per Pole | | Overcurrent Protection Fuse Required Class/Max Amp Rating† | | | | | | | | A | B | C | D | E | F w/cover | |
| | | | | | Line | Load | Line | Load | J | T | RK1 | RK5 | | | | | | | | | |
| PDHN-11-2-1* | 1 | 115 | (1) 2-14 | (1) 2-14 | (1) 2-6 | (1) 2-6 | 200 | 200 | 200 | 100 | 60 | 30 | 200,000 | 600 | 0.83 | 2.29 | 1.53 | - | 1.93 | 1.60 | CVR-2-1 |
| PDHN-11-2-2* | 1 | 115 | (1) 2-14 | (1) 2-14 | (1) 2-6 | (1) 2-6 | 200 | 200 | 200 | 100 | 60 | 30 | 200,000 | 600 | 1.46 | 2.29 | 1.53 | - | 1.93 | 1.60 | CVR-2-2 |
| PDHN-11-2-3* | 1 | 115 | (1) 2-14 | (1) 2-14 | (1) 2-6 | (1) 2-6 | 200 | 200 | 200 | 100 | 60 | 30 | 200,000 | 600 | 2.10 | 2.29 | 1.53 | 1.27 | 1.93 | 1.60 | CVR-2-3 |
| PDHN-11-2-4* | 1 | 115 | (1) 2-14 | (1) 2-14 | (1) 2-6 | (1) 2-6 | 200 | 200 | 200 | 100 | 60 | 30 | 200,000 | 600 | 2.75 | 2.29 | 1.53 | 1.92 | 1.93 | 1.60 | CVR-2-4 |
| PDHN-14-2-1* | 1 | 115 | (1) 2-14 | (4) 10-18 | (1) 2-6 | (4) 10-14 | 200 | 200 | 200 | 100 | 60 | 30 | 200,000 | 600 | 0.83 | 2.29 | 1.53 | - | 1.93 | 1.60 | CVR-2-1 |
| PDHN-14-2-2* | 1 | 115 | (1) 2-14 | (4) 10-18 | (1) 2-6 | (4) 10-14 | 200 | 200 | 200 | 100 | 60 | 30 | 200,000 | 600 | 1.46 | 2.29 | 1.53 | - | 1.93 | 1.60 | CVR-2-2 |
| PDHN-14-2-3* | 1 | 115 | (1) 2-14 | (4) 10-18 | (1) 2-6 | (4) 10-14 | 200 | 200 | 200 | 100 | 60 | 30 | 200,000 | 600 | 2.10 | 2.29 | 1.53 | 1.27 | 1.93 | 1.60 | CVR-2-3 |
| PDHN-14-2-4* | 1 | 115 | (1) 2-14 | (4) 10-18 | (1) 2-6 | (4) 10-14 | 200 | 200 | 200 | 100 | 60 | 30 | 200,000 | 600 | 2.75 | 2.29 | 1.53 | 1.92 | 1.93 | 1.60 | CVR-2-4 |
| PDH-11-2/0-1 | 2 | 175 | (1) 2/0-14 | (1) 2/0-14 | (1) 2/0-6 | (1) 2/0-6 | 200 | 200 | 200 | 100 | 60 | 30 | 100,000 | 600 | 1.00 | 3.00 | 2.42 | - | 2.25 | 2.57 | W/C |
| PDH-11-2/0-2 | 2 | 175 | (1) 2/0-14 | (1) 2/0-14 | (1) 2/0-6 | (1) 2/0-6 | 200 | 200 | 200 | 100 | 60 | 30 | 100,000 | 600 | 1.82 | 3.00 | 2.42 | 0.81 | 2.25 | 2.57 | W/C |
| PDH-11-2/0-3 | 2 | 175 | (1) 2/0-14 | (1) 2/0-14 | (1) 2/0-6 | (1) 2/0-6 | 200 | 200 | 200 | 100 | 60 | 30 | 100,000 | 600 | 2.55 | 3.00 | 2.42 | 1.63 | 2.25 | 2.57 | W/C |
| PDH-11-2/0-A‡ | 2 | 175 | (1) 2/0-14 | (1) 2/0-14 | (1) 2/0-6 | (1) 2/0-6 | 200 | 200 | 200 | 100 | 60 | 30 | 100,000 | 600 | 0.89 | 3.00 | 2.42 | - | 2.25 | - | NA |
| PDH-14-2/0-1 | 2 | 175 | (1) 2/0-14 | (4) 4-14 | (1) 2/0-6 | (4) 4-14 | 200 | 200 | 200 | 100 | 60 | 30 | 100,000 | 600 | 1.00 | 3.00 | 2.42 | - | 2.25 | 2.57 | W/C |
| PDH-14-2/0-2 | 2 | 175 | (1) 2/0-14 | (4) 4-14 | (1) 2/0-6 | (4) 4-14 | 200 | 200 | 200 | 100 | 60 | 30 | 100,000 | 600 | 1.82 | 3.00 | 2.42 | 0.81 | 2.25 | 2.57 | W/C |
| PDH-14-2/0-3 | 2 | 175 | (1) 2/0-14 | (4) 4-14 | (1) 2/0-6 | (4) 4-14 | 200 | 200 | 200 | 100 | 60 | 30 | 100,000 | 600 | 2.55 | 3.00 | 2.42 | 1.63 | 2.25 | 2.57 | W/C |
| PDH-14-2/0-A‡ | 2 | 175 | (1) 2/0-14 | (4) 4-14 | (1) 2/0-6 | (4) 4-14 | 200 | 200 | 200 | 100 | 60 | 30 | 100,000 | 600 | 0.89 | 3.00 | 2.42 | - | 2.25 | - | NA |
| PDH-12-350-1 | 3 | 310 | (1) 350-6 | (2) 2/0-14 | (1) 350-3/0 | (1) 2/0-1 | 600 | 600 | 400 | 200 | 60 | 30 | 100,000 | 600 | 1.96 | 4.00 | 3.49 | - | 3.38 | 3.49 | W/C |
| PDH-12-350-2 | 3 | 310 | (1) 350-6 | (2) 2/0-14 | (1) 350-3/0 | (1) 2/0-1 | 600 | 600 | 400 | 200 | 60 | 30 | 100,000 | 600 | 3.66 | 4.00 | 3.49 | 1.70 | 3.38 | 3.49 | W/C |
| PDH-12-350-3 | 3 | 310 | (1) 350-6 | (2) 2/0-14 | (1) 350-3/0 | (1) 2/0-1 | 600 | 600 | 400 | 200 | 60 | 30 | 100,000 | 600 | 5.36 | 4.00 | 3.49 | 3.40 | 3.38 | 3.49 | W/C |
| PDH-14-400-1 | 3 | 335 | (1) 400-6 | (4) 2-14 | (1) 400-3/0 | (4) 2-8 | 400 | 400 | 400 | 100 | 60 | 30 | 100,000 | 600 | 1.96 | 4.00 | 3.49 | - | 3.38 | 3.49 | W/C |
| PDH-14-400-2 | 3 | 335 | (1) 400-6 | (4) 2-14 | (1) 400-3/0 | (4) 2-8 | 400 | 400 | 400 | 100 | 60 | 30 | 100,000 | 600 | 3.66 | 4.00 | 3.49 | 1.70 | 3.38 | 3.49 | W/C |
| PDH-14-400-3 | 3 | 335 | (1) 400-6 | (4) 2-14 | (1) 400-3/0 | (4) 2-8 | 400 | 400 | 400 | 100 | 60 | 30 | 100,000 | 600 | 5.36 | 4.00 | 3.49 | 3.40 | 3.38 | 3.49 | W/C |
| PDH-26-2/0-1 | 3 | 350 | (2) 2/0-14 | (6) 4-14 | (2) 2/0-2 | (6) 4-8 | 400 | 400 | 400 | 100 | 60 | 30 | 100,000 | 600 | 1.96 | 4.00 | 3.49 | - | 3.38 | 3.49 | W/C |
| PDH-26-2/0-2 | 3 | 350 | (2) 2/0-14 | (6) 4-14 | (2) 2/0-2 | (6) 4-8 | 400 | 400 | 400 | 100 | 60 | 30 | 100,000 | 600 | 3.66 | 4.00 | 3.49 | 1.70 | 3.38 | 3.49 | W/C |
| PDH-26-2/0-3 | 3 | 350 | (2) 2/0-14 | (6) 4-14 | (2) 2/0-2 | (6) 4-8 | 400 | 400 | 400 | 100 | 60 | 30 | 100,000 | 600 | 5.36 | 4.00 | 3.49 | 3.40 | 3.38 | 3.49 | W/C |
| PDH-14A-500-1 | 3 | 380 | (1) 500-4 (3) 2-14 (1) 350-6 | (1) 500-4 | (1) 500-4 | (3) 2-14 (1) 350-6 | 600 | 600 | 400 | 200 | 60 | 30 | 100,000 | 600 | 1.96 | 4.00 | 3.49 | - | 3.38 | 3.49 | W/C |
| PDH-14A-500-2 | 3 | 380 | (1) 500-4 (3) 2-14 (1) 350-6 | (1) 500-4 | (1) 500-4 | (3) 2-14 (1) 350-6 | 600 | 600 | 400 | 200 | 60 | 30 | 100,000 | 600 | 3.66 | 4.00 | 3.49 | 1.70 | 3.38 | 3.49 | W/C |
| PDH-14A-500-3 | 3 | 380 | (1) 500-4 (3) 2-14 (1) 350-6 | (1) 500-4 | (1) 500-4 | (3) 2-14 (1) 350-6 | 600 | 600 | 400 | 200 | 60 | 30 | 100,000 | 600 | 5.36 | 4.00 | 3.49 | 3.40 | 3.38 | 3.49 | W/C |
| PDH-11-600-1 | 3 | 420 | (1) 600-2 | (1) 600-2 | (1) 600-2 | (1) 600-2 | 400 | 400 | 400 | 200 | 60 | 30 | 100,000 | 600 | 1.96 | 4.00 | 3.49 | - | 3.38 | 3.49 | W/C |
| PDH-11-600-2 | 3 | 420 | (1) 600-2 | (1) 600-2 | (1) 600-2 | (1) 600-2 | 400 | 400 | 400 | 200 | 60 | 30 | 100,000 | 600 | 3.66 | 4.00 | 3.49 | 1.70 | 3.38 | 3.49 | W/C |
| PDH-11-600-3 | 3 | 420 | (1) 600-2 | (1) 600-2 | (1) 600-2 | (1) 600-2 | 400 | 400 | 400 | 200 | 60 | 30 | 100,000 | 600 | 5.36 | 4.00 | 3.49 | 3.40 | 3.38 | 3.49 | W/C |

All wire sizes, unless noted otherwise, are American Wire Gauge (AWG)

* Cover not standard, available as an option. ‡ Adder Block, cover not available. W/C supplied with cover

† For further details on conductors, fuse ratings, and additional SCCR ratings please refer to product data sheets.

Power Distribution Block

High Short-Circuit Current Rating

RoHS
Compliant



TYPE PDH

Features

- Manufactured from high strength aluminum
- UL 1059 Recognized 90° C/194° F 600 Volts and CSA Certified
- Electro-tin plated
- High Short Circuit Rating 100K RMS SYM Amps
- For use with building code or flexible conductor

Benefits

- Suitable for use with either copper or aluminum conductors
- Ensures reliability
- Provides low contact resistance
- Added protection

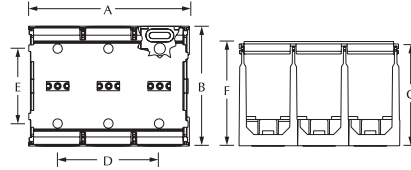
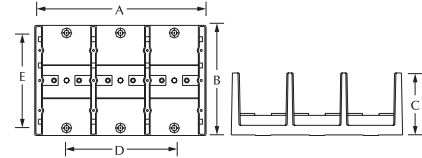

Fig. 3



ig. 4

| Catalog Number | Figure No. | Amps | Rated Conductor Range | | High SCCR Conditions | | | | | | | | SCCR RMS SYM Amps | Volts Max | Dimensions (in.) | | | | | | Cover ID |
|----------------|------------|------|-----------------------|------------------------|------------------------------|-------------|-----------------------------------------------------------|-----|-----|-----|----|----|-------------------|-----------|------------------|------|------|------|------|-----------|----------|
| | | | Line | Load | Suitable Conductors Per Pole | | Overcurrent Protection Fuse Required Class/Max Amp Rating | | | | | | | | A | B | C | D | E | F w/cover | |
| | | | | | Line | Load | J | T | RK1 | RK5 | G | CC | | | | | | | | | |
| PDH-18-600-1 | 3 | 420 | (1) 600-2 | (8) 2-14 | (1) 600-3/0 | (8) 2-8 | 400 | 400 | 400 | 200 | 60 | 30 | 100,000 | 600 | 1.96 | 4.00 | 3.49 | - | 3.38 | 3.49 | W/C |
| PDH-18-600-2 | 3 | 420 | (1) 600-2 | (8) 2-14 | (1) 600-3/0 | (8) 2-8 | 400 | 400 | 400 | 200 | 60 | 30 | 100,000 | 600 | 3.66 | 4.00 | 3.49 | 1.70 | 3.38 | 3.49 | W/C |
| PDH-18-600-3 | 3 | 420 | (1) 600-2 | (8) 2-14 | (1) 600-3/0 | (8) 2-8 | 400 | 400 | 400 | 200 | 60 | 30 | 100,000 | 600 | 5.36 | 4.00 | 3.49 | 3.40 | 3.38 | 3.49 | W/C |
| PDH-112-600-1 | 3 | 420 | (1) 600-2 | (12) 4-14 | (1) 600-3/0 | (12) 4-8 | 600 | 600 | 400 | 200 | 60 | 30 | 100,000 | 600 | 1.96 | 4.00 | 3.49 | - | 3.38 | 3.49 | W/C |
| PDH-112-600-2 | 3 | 420 | (1) 600-2 | (12) 4-14 | (1) 600-3/0 | (12) 4-8 | 600 | 600 | 400 | 200 | 60 | 30 | 100,000 | 600 | 3.66 | 4.00 | 3.49 | 1.70 | 3.38 | 3.49 | W/C |
| PDH-112-600-3 | 3 | 420 | (1) 600-2 | (12) 4-14 | (1) 600-3/0 | (12) 4-8 | 600 | 600 | 400 | 200 | 60 | 30 | 100,000 | 600 | 5.36 | 4.00 | 3.49 | 3.40 | 3.38 | 3.49 | W/C |
| PDH-19A-600-1 | 3 | 420 | (1) 600-2 | (6) 2-14 (3) 1/0-14 | (1) 600-3/0 | (9) 1/0-8 | 600 | 600 | 400 | 200 | 60 | 30 | 100,000 | 600 | 1.96 | 4.00 | 3.49 | - | 3.38 | 3.49 | W/C |
| PDH-19A-600-2 | 3 | 420 | (1) 600-2 | (6) 2-14 (3) 1/0-14 | (1) 600-3/0 | (9) 1/0-8 | 600 | 600 | 400 | 200 | 60 | 30 | 100,000 | 600 | 3.66 | 4.00 | 3.49 | 1.70 | 3.38 | 3.49 | W/C |
| PDH-19A-600-3 | 3 | 420 | (1) 600-2 | (6) 2-14 (3) 1/0-14 | (1) 600-3/0 | (9) 1/0-8 | 600 | 600 | 400 | 200 | 60 | 30 | 100,000 | 600 | 5.36 | 4.00 | 3.49 | 3.40 | 3.38 | 3.49 | W/C |
| PDH-22-250-1 | 3 | 510 | (2) 250-1/0 | (2) 250-1/0 | (2) 250-1/0 | (2) 250-1/0 | 600 | 600 | 400 | 200 | 60 | 30 | 100,000 | 600 | 1.96 | 4.00 | 3.49 | - | 3.38 | 3.49 | W/C |
| PDH-22-250-2 | 3 | 510 | (2) 250-1/0 | (2) 250-1/0 | (2) 250-1/0 | (2) 250-1/0 | 600 | 600 | 400 | 200 | 60 | 30 | 100,000 | 600 | 3.66 | 4.00 | 3.49 | 1.70 | 3.38 | 3.49 | W/C |
| PDH-22-250-3 | 3 | 510 | (2) 250-1/0 | (2) 250-1/0 | (2) 250-1/0 | (2) 250-1/0 | 600 | 600 | 400 | 200 | 60 | 30 | 100,000 | 600 | 5.36 | 4.00 | 3.49 | 3.40 | 3.38 | 3.49 | W/C |
| PDH-28-250-1 | 3 | 510 | (2) 250-1/0 | (8) 2-14 | (2) 250-1/0 | (8) 2-14 | 600 | 600 | 600 | 200 | 60 | 30 | 100,000 | 600 | 1.96 | 4.00 | 3.49 | - | 3.38 | 3.49 | W/C |
| PDH-28-250-2 | 3 | 510 | (2) 250-1/0 | (8) 2-14 | (2) 250-1/0 | (8) 2-14 | 600 | 600 | 600 | 200 | 60 | 30 | 100,000 | 600 | 3.66 | 4.00 | 3.49 | 1.70 | 3.38 | 3.49 | W/C |
| PDH-28-250-3 | 3 | 510 | (2) 250-1/0 | (8) 2-14 | (2) 250-1/0 | (8) 2-14 | 600 | 600 | 600 | 200 | 60 | 30 | 100,000 | 600 | 5.36 | 4.00 | 3.49 | 3.40 | 3.38 | 3.49 | W/C |
| PDH-212-250-1 | 3 | 510 | (2) 250-1/0 | (12) 4-14 | (2) 250-1/0 | (12) 4-14 | 600 | 600 | 600 | 200 | 60 | 30 | 100,000 | 600 | 1.96 | 4.00 | 3.49 | - | 3.38 | 3.49 | W/C |
| PDH-212-250-2 | 3 | 510 | (2) 250-1/0 | (12) 4-14 | (2) 250-1/0 | (12) 4-14 | 600 | 600 | 600 | 200 | 60 | 30 | 100,000 | 600 | 3.66 | 4.00 | 3.49 | 1.70 | 3.38 | 3.49 | W/C |
| PDH-212-250-3 | 3 | 510 | (2) 250-1/0 | (12) 4-14 | (2) 250-1/0 | (12) 4-14 | 600 | 600 | 600 | 200 | 60 | 30 | 100,000 | 600 | 5.36 | 4.00 | 3.49 | 3.40 | 3.38 | 3.49 | W/C |
| PDH-22-350-1* | 4 | 620 | (2) 350-4 | (2) 350-4 | (2) 350-4 | (2) 350-4 | 450 | 450 | 400 | 200 | 60 | 30 | 100,000 | 600 | 3.17 | 5.50 | 3.12 | - | 4.75 | 3.18 | C-6-1 |
| PDH-22-350-2* | 4 | 620 | (2) 350-4 | (2) 350-4 | (2) 350-4 | (2) 350-4 | 450 | 450 | 400 | 200 | 60 | 30 | 100,000 | 600 | 5.85 | 5.50 | 3.12 | 2.69 | 4.75 | 3.18 | C-6-2 |
| PDH-22-350-3* | 4 | 620 | (2) 350-4 | (2) 350-4 | (2) 350-4 | (2) 350-4 | 450 | 450 | 400 | 200 | 60 | 30 | 100,000 | 600 | 8.54 | 5.50 | 3.12 | 5.38 | 4.75 | 3.18 | C-6-3 |
| PDH-22-500-1* | 4 | 760 | (2) 500-4 | (2) 500-4 | (2) 500-4 | (2) 500-4 | 600 | 600 | 400 | 200 | 60 | 30 | 100,000 | 600 | 3.17 | 5.50 | 3.12 | - | 4.75 | 3.18 | C-6-1 |
| PDH-22-500-2* | 4 | 760 | (2) 500-4 | (2) 500-4 | (2) 500-4 | (2) 500-4 | 600 | 600 | 400 | 200 | 60 | 30 | 100,000 | 600 | 5.85 | 5.50 | 3.12 | 2.69 | 4.75 | 3.18 | C-6-2 |
| PDH-22-500-3* | 4 | 760 | (2) 500-4 | (2) 500-4 | (2) 500-4 | (2) 500-4 | 600 | 600 | 400 | 200 | 60 | 30 | 100,000 | 600 | 8.54 | 5.50 | 3.12 | 5.38 | 4.75 | 3.18 | C-6-3 |
| PDH-28-500-1* | 4 | 760 | (2) 500-6 | (8) 2/0-14 | (2) 500-250 | (8) 2/0-14 | 600 | 600 | 400 | 200 | 60 | 30 | 100,000 | 600 | 3.17 | 5.50 | 3.12 | - | 4.75 | 3.18 | C-6-1 |
| PDH-28-500-2* | 4 | 760 | (2) 500-6 | (8) 2/0-14 | (2) 500-250 | (8) 2/0-14 | 600 | 600 | 400 | 200 | 60 | 30 | 100,000 | 600 | 5.85 | 5.50 | 3.12 | 2.69 | 4.75 | 3.18 | C-6-2 |
| PDH-28-500-3* | 4 | 760 | (2) 500-6 | (8) 2/0-14 | (2) 500-250 | (8) 2/0-14 | 600 | 600 | 400 | 200 | 60 | 30 | 100,000 | 600 | 8.54 | 5.50 | 3.12 | 5.38 | 4.75 | 3.18 | C-6-3 |
| PDH-212-500-1* | 4 | 760 | (2) 500-6 | (12) 4-14 | (2) 500-250 | (12) 4-8 | 400 | 400 | 400 | 200 | 60 | 30 | 100,000 | 600 | 3.17 | 5.50 | 3.12 | - | 4.75 | 3.18 | C-6-1 |
| PDH-212-500-2* | 4 | 760 | (2) 500-6 | (12) 4-14 | (2) 500-250 | (12) 4-8 | 400 | 400 | 400 | 200 | 60 | 30 | 100,000 | 600 | 5.85 | 5.50 | 3.12 | 2.69 | 4.75 | 3.18 | C-6-2 |
| PDH-212-500-3* | 4 | 760 | (2) 500-6 | (12) 4-14 | (2) 500-250 | (12) 4-8 | 400 | 400 | 400 | 200 | 60 | 30 | 100,000 | 600 | 8.54 | 5.50 | 3.12 | 5.38 | 4.75 | 3.18 | C-6-3 |

All wire sizes, unless noted otherwise, are American Wire Gauge (AWG)

* Cover not standard, available as an option. W/C supplied with cover

† For further details on conductors, fuse ratings, and additional SCCR ratings please refer to product data sheets.

Power Distribution Block

High Short-Circuit Current Rating



TYPE PDE

Features

- Manufactured from high strength aluminum
- UL Listed 75° C/167° F and CSA Certified, 600 volts
- Electro-tin plated
- High Short Circuit Rating 100K RMS SYM Amps
- Enclosed block provides IP-20 touch protection
- For use with building code or flexible conductor

Benefits

- Suitable for use with either copper or aluminum conductors
- Ensures reliability
- Provides low contact resistance
- Added protection

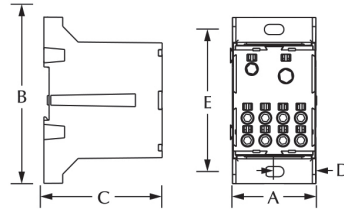

F

| Catalog Number | Amps (CU Wire) | Rated Conductor Range | | High SCCR Conditions | | | | | | | | SCCR RMS SYM Amps | Volts Max | Dimensions (in.) | | | | |
|----------------|----------------|-------------------------|------------|------------------------------|-------------|------------------------------------------------------------|-----|-----|-----|----|----|-------------------|-----------|------------------|------|------|------|------|
| | | | | Suitable Conductors Per Pole | | Overcurrent Protection Fuse Required Class/Max Amp Rating† | | | | | | | | | | | | |
| | | | | Line | Load | J | T | RK1 | RK5 | G | CC | | | | | | | |
| PDE-11-3/0* | 200 | (1) 3/0-14 | (1) 3/0-14 | (1) 3/0-8 | (1) 3/0-8 | 225 | 225 | 200 | 60 | 60 | 30 | 100,000 | 600 | 1.20 | 3.61 | 2.71 | .56 | 3.00 |
| PDE-11-3/0-CU* | 200 | (1) 3/0-14 | (1) 3/0-14 | (1) 3/0-8 | (1) 3/0-8 | 225 | 225 | 200 | 60 | 60 | 30 | 100,000 | 600 | 1.20 | 3.61 | 2.71 | .56 | 3.00 |
| PDE-14-3/0* | 200 | (1) 3/0-14 | (4) 2-14 | (1) 3/0-8 | (4) 2-14 | 225 | 225 | 200 | 60 | 60 | 30 | 100,000 | 600 | 1.20 | 3.61 | 2.71 | .56 | 3.00 |
| PDE-14-3/0-CU* | 200 | (1) 3/0-14 | (4) 2-14 | (1) 3/0-8 | (4) 2-14 | 225 | 225 | 200 | 60 | 60 | 30 | 100,000 | 600 | 1.20 | 3.61 | 2.71 | .56 | 3.00 |
| PDE-18-400‡ | 335 | (1) 400-6 (1) 2/0-14 | (8) 2-16 | (1) 400-3/0 | (8) 2-8 | 400 | 400 | 400 | 200 | 60 | 30 | 100,000 | 600 | 2.27 | 4.39 | 3.14 | 1.11 | 3.75 |
| DE-18-400-CU‡ | 335 | (1) 400-6 | (8) 2-16 | (1) 400-3/0 | (8) 2-8 | 400 | 400 | 400 | 200 | 60 | 30 | 100,000 | 600 | 2.27 | 4.39 | 3.14 | 1.11 | 3.75 |
| PDE-22-250‡ | 510 | (2) 250-6 | (2) 250-6 | (2) 250-1/0 | (2) 250-1/0 | 400 | 400 | 400 | 200 | 60 | 30 | 100,000 | 600 | 2.27 | 4.39 | 3.14 | 1.11 | 3.75 |
| PDE-22-250-CU‡ | 510 | (2) 250-6 | (2) 250-6 | (2) 250-1/0 | (2) 250-1/0 | 400 | 400 | 400 | 200 | 60 | 30 | 100,000 | 600 | 2.27 | 4.39 | 3.14 | 1.11 | 3.75 |

All wire sizes, unless noted otherwise, are American Wire Gauge (AWG)

All PDE blocks are single pole and snap together for 2 and 3 pole configurations

† For further details on conductors, fuse ratings, and additional SCCR ratings please refer to product data sheets

‡ UL Recognized

* Din Rail mountable

-CU designates copper conductor only

Power Distribution Block

High Short-Circuit Current Rating

RoHS
Compliant

UL
LISTED

SA
LR-29601

TYPE
PDL

Features

- Manufactured from high strength aluminum
- UL Listed 75° C/167° F and CSA Certified, 600 volts
- Electro-tin plated
- High Short Circuit Rating 100K RMS SYM Amps

Benefits

- Suitable for use with either copper or aluminum conductors
- Ensures reliability
- Provides low contact resistance
- Added protection

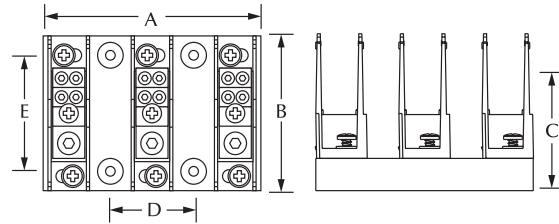

| Catalog Number | Amps (CU Wire) | Rated Conductor Range | | High SCCR Conditions | | | | | | | | SCCR RMS SYM Amps | Volts Max | Dimensions (in.) | | | | |
|----------------|----------------|-----------------------|------------------------|------------------------------|-----------|------------------------------------------------------------|------|-----|-----|-----|-----|-------------------|-----------|------------------|------|------|------|------|
| | | | | Suitable Conductors Per Pole | | Overcurrent Protection Fuse Required Class/Max Amp Rating† | | | | | | | | | | | | |
| | | | | Line | Load | Line | Load | J | T | RK1 | RK5 | | | G | CC | A | B | C |
| PDL-11-2/0-3 | 175 | (1) 2/0-14 | (1) 2/0-14 | (1) 2/0-6 | (1) 2/0-6 | 200 | 200 | 200 | 100 | 60 | 30 | 100,000 | 600 | 4.25 | 3.00 | 3.05 | 1.63 | 2.25 |
| PDL-14-2/0-3 | 175 | (1) 2/0-14 | (4) 4-14 | (1) 2/0-6 | (4) 4-14 | 200 | 200 | 200 | 100 | 60 | 30 | 100,000 | 600 | 4.25 | 3.00 | 3.05 | 1.63 | 2.25 |
| PDL-16-2/0-3 | 175 | (1) 2/0-14 | (6) 4-14 | (1) 2/0-6 | (6) 4-14 | 200 | 200 | 200 | 100 | 60 | 30 | 100,000 | 600 | 4.25 | 3.00 | 3.05 | 1.63 | 2.25 |
| PDL-16-400-3 | 335 | (1) 400-6 | (6) 2-14 | (1) 400-3/0 | (6) 2-8 | 400 | 400 | 400 | 100 | 60 | 30 | 100,000 | 600 | 6.00 | 5.50 | 3.96 | 3.25 | 4.75 |
| PDL-112-600-3 | 335 | (1) 600-2 | (12) 4-14 | (1) 600-3/0 | (12) 4-8 | 600 | 600 | 400 | 200 | 60 | 30 | 100,000 | 600 | 6.00 | 5.50 | 3.96 | 3.25 | 4.75 |
| PDL-19A-600-3 | 335 | (1) 600-2 | (3) 1/0-14 (6) 2-14 | (1) 600-3/0 | (9) 1/0-8 | 600 | 600 | 400 | 200 | 60 | 30 | 100,000 | 600 | 6.00 | 5.50 | 3.96 | 3.25 | 4.75 |

F

All wire sizes, unless noted otherwise, are American Wire Gauge (AWG)

PDL Distribution Blocks are also UL listed with high SCCR ratings with certain Circuit Breaker Combinations - consult factory.

† For further details on conductors, fuse ratings, and additional SCCR ratings please refer to product data sheets.

Power Distribution Block

RoHS
Compliant



TYPE PDS

Features

- Connector, copper, tin plated
- Stud, brass, tin plated
- Phenolic base and cover material
- UL Recognized 75° C/167° F and CSA Certified
- Insulator base adders available
- Din rail or panel mountable
- Rated for 600 volts

Benefits

- Rated for copper conductor
- Intended for wires terminated with crimp lugs
- Ensures reliability
- Easily snap together to create variable pole power blocks

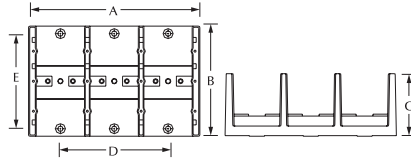
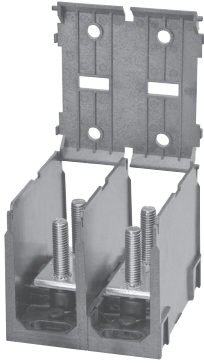

F

| Catalog Number | Amps | Rated Conductor Range | | Stud Ctr to Ctr | Line In | Line Out | Dimensions (in.) | | | | | F w/ cover | Cover ID |
|----------------|------|-----------------------|---------------------|-----------------|---------|----------|------------------|------|------|------|------|------------|----------|
| | | Line | Load | | | | A | B | C | D | E | | |
| PDS-11-KE-1† | 230 | (1) 3/8-16 X 1-3/16 | (1) 1/4-20 x 1-3/16 | - | Stud | Stud | 1.94 | 4.00 | 2.61 | - | 3.38 | 3.38 | C-4-1 |
| PDS-11-KE-2† | 230 | (1) 3/8-16 X 1-3/16 | (1) 1/4-20 x 1-3/16 | - | Stud | Stud | 3.47 | 4.00 | 2.61 | 1.53 | 3.38 | 3.38 | C-4-2 |
| PDS-11-KE-3† | 230 | (1) 3/8-16 X 1-3/16 | (1) 1/4-20 x 1-3/16 | - | Stud | Stud | 5.00 | 4.00 | 2.61 | 3.06 | 3.38 | 3.38 | C-4-3 |
| PDS-11-PP-1 | 230 | (1) 3/8-16 x 1-7/16 | (1) 3/8-16 x 1-7/16 | - | Stud | Stud | 2.29 | 4.75 | 2.90 | - | 4.13 | 4.13 | C-5-1 |
| PDS-11-PP-2 | 230 | (1) 3/8-16 x 1-7/16 | (1) 3/8-16 x 1-7/16 | - | Stud | Stud | 4.17 | 4.75 | 2.90 | 1.88 | 4.13 | 4.13 | C-5-2 |
| PDS-11-PP-3 | 230 | (1) 3/8-16 x 1-7/16 | (1) 3/8-16 x 1-7/16 | - | Stud | Stud | 6.05 | 4.75 | 2.90 | 3.76 | 4.13 | 4.13 | C-5-3 |
| PDS-12-PC-1 | 260 | (1) 3/8-16 x 1-7/16 | (2) 1/4-20 x 9/16 | .750 | Stud | Stud | 2.29 | 4.75 | 2.90 | - | 4.13 | 4.13 | C-5-1 |
| PDS-12-PC-2 | 260 | (1) 3/8-16 x 1-7/16 | (2) 1/4-20 x 9/16 | .750 | Stud | Stud | 4.17 | 4.75 | 2.90 | 1.88 | 4.13 | 4.13 | C-5-2 |
| PDS-12-PC-3 | 260 | (1) 3/8-16 x 1-7/16 | (2) 1/4-20 x 9/16 | .750 | Stud | Stud | 6.05 | 4.75 | 2.90 | 3.76 | 4.13 | 4.13 | C-5-3 |
| PDS-12-PG-1 | 360 | (1) 3/8-16 x 1-7/16 | (2) 1/4-20 X 1-7/16 | 1.125 | Stud | Stud | 3.17 | 5.50 | 3.12 | - | 4.75 | 4.75 | C-6-1 |
| PDS-12-PG-2 | 360 | (1) 3/8-16 x 1-7/16 | (2) 1/4-20 X 1-7/16 | 1.125 | Stud | Stud | 5.85 | 5.50 | 3.12 | 2.69 | 4.75 | 4.75 | C-6-2 |
| PDS-12-PG-3 | 360 | (1) 3/8-16 x 1-7/16 | (2) 1/4-20 X 1-7/16 | 1.125 | Stud | Stud | 8.54 | 5.50 | 3.12 | 5.38 | 4.75 | 4.75 | C-6-3 |
| PDS-12-PP-1 | 360 | (1) 3/8-16 x 1-7/16 | (2) 3/8-16 x 1-7/16 | 1.125 | Stud | Stud | 3.17 | 5.50 | 3.12 | - | 4.75 | 4.75 | C-6-1 |
| PDS-12-PP-2 | 360 | (1) 3/8-16 x 1-7/16 | (2) 3/8-16 x 1-7/16 | 1.125 | Stud | Stud | 5.85 | 5.50 | 3.12 | 2.69 | 4.75 | 4.75 | C-6-2 |
| PDS-12-PP-3 | 360 | (1) 3/8-16 x 1-7/16 | (2) 3/8-16 x 1-7/16 | 1.125 | Stud | Stud | 8.54 | 5.50 | 3.12 | 5.38 | 4.75 | 4.75 | C-6-3 |
| PDS-11-RR-1 | 410 | (1) 1/2-13 x 1-7/16 | (1) 1/2-13 x 1-7/16 | - | Stud | Stud | 3.17 | 5.50 | 3.12 | - | 4.75 | 4.75 | C-6-1 |
| PDS-11-RR-2 | 410 | (1) 1/2-13 x 1-7/16 | (1) 1/2-13 x 1-7/16 | - | Stud | Stud | 5.85 | 5.50 | 3.12 | 2.69 | 4.75 | 4.75 | C-6-2 |
| PDS-11-RR-3 | 410 | (1) 1/2-13 x 1-7/16 | (1) 1/2-13 x 1-7/16 | - | Stud | Stud | 8.54 | 5.50 | 3.12 | 5.38 | 4.75 | 4.75 | C-6-3 |
| PDS-11-HH-1 | 840 | (1) 3/8-16 x 1 | (1) 3/8-16 x 1 | - | Stud | Stud | 2.29 | 4.75 | 2.90 | - | 4.13 | 4.13 | C-5-1 |
| PDS-11-HH-2 | 840 | (1) 3/8-16 x 1 | (1) 3/8-16 x 1 | - | Stud | Stud | 4.17 | 4.75 | 2.90 | 1.88 | 4.13 | 4.13 | C-5-2 |
| PDS-11-HH-3 | 840 | (1) 3/8-16 x 1 | (1) 3/8-16 x 1 | - | Stud | Stud | 6.05 | 4.75 | 2.90 | 3.76 | 4.13 | 4.13 | C-5-3 |

All wire sizes, unless noted otherwise, are American Wire Gauge (AWG) For further details on conductor classes please refer to product data sheets
UL1059 terminal block standard file No. E84782 CSA certified CSA c22.2 No. 158, File number MC 249467 (wire classes B & C only)

† Connector aluminum, tin plated

W/C supplied with cover

Power Distribution Block

RoHS
Compliant



TYPE PDS

Features

- Connector, copper, tin plated
- Stud, brass, tin plated
- Phenolic base and cover material
- UL Recognized 75° C/167° F and CSA Certified
- Insulator base adders available
- Din rail or panel mountable
- Rated for 600 volts

Benefits

- Rated for copper conductor
- Intended for wires terminated with crimp lugs
- Ensures reliability
- Easily snap together to create variable pole power blocks

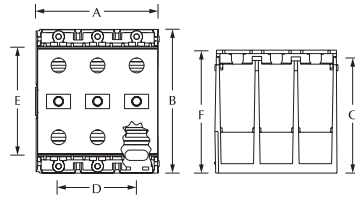
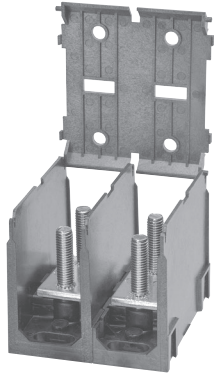

Fig. 1

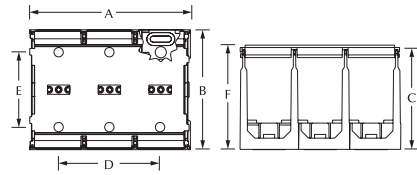

Fig. 2

| Catalog Number | Figure No. | Amps | Rated Conductor Range | | Stud Ctr to Ctr | Line In | Line Out | Dimensions (in.) | | | | | F w/ cover | Cover ID |
|----------------|------------|------|-----------------------|---------------------|-----------------|---------|----------|------------------|------|------|------|------|------------|----------|
| | | | Line | Load | | | | A | B | C | D | E | | |
| PDS-11-UU-A+ | 1 | 200 | (1) M6 x 15 | (1) M6 x 15 | - | Metric | Metric | 1.00 | 3.00 | 2.42 | - | 2.25 | - | NA |
| PDS-11-UU-1 | 1 | 200 | (1) M6 x 15 | (1) M6 x 15 | - | Metric | Metric | 1.00 | 3.00 | 2.42 | - | 2.25 | 2.57 | W/C |
| PDS-11-UU-2 | 1 | 200 | (1) M6 x 15 | (1) M6 x 15 | - | Metric | Metric | 1.82 | 3.00 | 2.42 | 0.81 | 2.25 | 2.57 | W/C |
| PDS-11-UU-3 | 1 | 200 | (1) M6 x 15 | (1) M6 x 15 | - | Metric | Metric | 2.55 | 3.00 | 2.42 | 1.62 | 2.25 | 2.57 | W/C |
| PDS-11-CC-A | 1 | 200 | (1) 1/4-20 x 9/16 | (1) 1/4-20 x 9/16 | - | Stud | Stud | 1.00 | 3.00 | 2.42 | - | 2.25 | - | NA |
| PDS-11-CC-1 | 1 | 200 | (1) 1/4-20 x 9/16 | (1) 1/4-20 x 9/16 | - | Stud | Stud | 1.00 | 3.00 | 2.42 | - | 2.25 | 2.57 | W/C |
| PDS-11-CC-2 | 1 | 200 | (1) 1/4-20 x 9/16 | (1) 1/4-20 x 9/16 | - | Stud | Stud | 1.82 | 3.00 | 2.42 | 0.81 | 2.25 | 2.57 | W/C |
| PDS-11-CC-3 | 1 | 200 | (1) 1/4-20 x 9/16 | (1) 1/4-20 x 9/16 | - | Stud | Stud | 2.55 | 3.00 | 2.42 | 1.62 | 2.25 | 2.57 | W/C |
| PDS-11-SS-1* | 2 | 310 | (1) M10 x 30 | (1) M10 x 30 | - | Metric | Metric | 1.96 | 4.00 | 3.33 | - | 3.38 | 3.49 | W/C |
| PDS-11-SS-2* | 2 | 310 | (1) M10 x 30 | (1) M10 x 30 | - | Metric | Metric | 3.66 | 4.00 | 3.33 | 1.70 | 3.38 | 3.49 | W/C |
| PDS-11-SS-3* | 2 | 310 | (1) M10 x 30 | (1) M10 x 30 | - | Metric | Metric | 5.36 | 4.00 | 3.33 | 3.40 | 3.38 | 3.49 | W/C |
| PDS-11-KK-1* | 2 | 310 | (1) 3/8-16 x 1-3/16 | (1) 3/8-16 x 1-3/16 | - | Stud | Stud | 1.96 | 4.00 | 3.33 | - | 3.38 | 3.49 | W/C |
| PDS-11-KK-2* | 2 | 310 | (1) 3/8-16 x 1-3/16 | (1) 3/8-16 x 1-3/16 | - | Stud | Stud | 3.66 | 4.00 | 3.33 | 1.70 | 3.38 | 3.49 | W/C |
| PDS-11-KK-3* | 2 | 310 | (1) 3/8-16 x 1-3/16 | (1) 3/8-16 x 1-3/16 | - | Stud | Stud | 5.36 | 4.00 | 3.33 | 3.40 | 3.38 | 3.49 | W/C |

All wire sizes, unless noted otherwise, are American Wire Gauge (AWG)

For further details on conductor classes please refer to product data sheets

UL1059 terminal block standard file No. E84782 CSA certified CSA c22.2 No. 158, File number MC 249467 (wire classes B & C only)

+ Cover not available for adder blocks

- Indicates that snap on cover is standard

W/C supplied with cover

* Panel mountable



Power Distribution Block

RoHS
Compliant



TYPE PDM

Features

- Connector, high conductive aluminium, tin plated
- Brass, tin plated stud
- UL Recognized 75° C/167° F and CSA Certified
- Insulator base adders available
- Panel Mountable
- Rated for 600 volts

Benefits

- Rated for copper and aluminum conductor
- Intended for wires terminated with crimp lugs
- Ensures Reliability
- Easily snap together to create variable pole power blocks

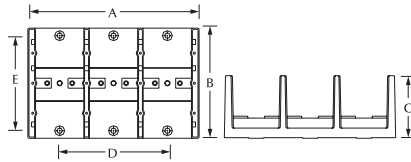
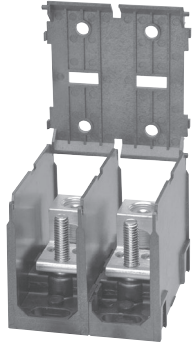

Fig. 1

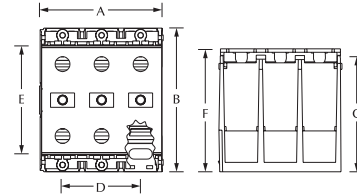

Fig. 2

| Catalog Number | Fig. No. | Amps | Rated Conductor Range | | Stud Ctr to Ctr | Line In | Line Out | Max A/C | Dimensions (in.) | | | | | | Cover ID |
|-----------------|----------|------|-----------------------|---------------------|-----------------|---------|----------|---------|------------------|------|------|------|------|-----------|----------|
| | | | Line | Load | | | | | A | B | C | D | E | F w/cover | |
| PDM-11-2/0F-1 | 1 | 175 | (1) 2/0-#14 Awg | (1) 1/4-20 x 1-3/8 | - | Lug | Stud | - | 1.94 | 4.00 | 2.61 | - | 3.38 | 3.38 | C-4-1 |
| PDM-11-2/0F-2 | 1 | 175 | (1) 2/0-#14 Awg | (1) 1/4-20 x 1-3/8 | - | Lug | Stud | - | 3.47 | 4.00 | 2.61 | 1.53 | 3.38 | 3.38 | C-4-2 |
| PDM-11-2/0F-3 | 1 | 175 | (1) 2/0-#14 Awg | (1) 1/4-20 x 1-3/8 | - | Lug | Stud | - | 5.00 | 4.00 | 2.61 | 3.06 | 3.38 | 3.38 | C-4-3 |
| PDM-11-350J-1 | 1 | 310 | (1) 350 kcmil-#6 Awg | (1) 3/8-16 x 1-1/8 | - | Lug | Stud | 65KA | 1.94 | 4.00 | 2.61 | - | 3.38 | 3.38 | C-4-1 |
| PDM-11-350J-2 | 1 | 310 | (1) 350 kcmil-#6 Awg | (1) 3/8-16 x 1-1/8 | - | Lug | Stud | 65KA | 3.47 | 4.00 | 2.61 | 1.53 | 3.38 | 3.38 | C-4-2 |
| PDM-11-350J-3 | 1 | 310 | (1) 350 kcmil-#6 Awg | (1) 3/8-16 x 1-1/8 | - | Lug | Stud | 65KA | 5.00 | 4.00 | 2.61 | 3.06 | 3.38 | 3.38 | C-4-3 |
| PDM-12-500D-1 | 1 | 380 | (1) 500 kcmil-#4 Awg | (2) 1/4-20 x 1-1/16 | .750 | Lug | Stud | - | 2.29 | 4.75 | 2.90 | - | 4.13 | 4.13 | C-5-1 |
| PDM-12-500D-2 | 1 | 380 | (1) 500 kcmil-#4 Awg | (2) 1/4-20 x 1-1/16 | .750 | Lug | Stud | - | 4.17 | 4.75 | 2.90 | 1.88 | 4.13 | 4.13 | C-5-2 |
| PDM-12-500D-3 | 1 | 380 | (1) 500 kcmil-#4 Awg | (2) 1/4-20 x 1-1/16 | .750 | Lug | Stud | - | 6.05 | 4.75 | 2.90 | 3.76 | 4.13 | 4.13 | C-5-3 |
| PDM-11-500N-1 | 1 | 380 | (1) 500 kcmil-#4 Awg | (1) 3/8-16 x 1-5/16 | - | Lug | Stud | - | 2.29 | 4.75 | 2.90 | - | 4.13 | 4.13 | C-5-1 |
| PDM-11-500N-2 | 1 | 380 | (1) 500 kcmil-#4 Awg | (1) 3/8-16 x 1-5/16 | - | Lug | Stud | - | 4.17 | 4.75 | 2.90 | 1.88 | 4.13 | 4.13 | C-5-2 |
| PDM-11-500N-3 | 1 | 380 | (1) 500 kcmil-#4 Awg | (1) 3/8-16 x 1-5/16 | - | Lug | Stud | - | 6.05 | 4.75 | 2.90 | 3.76 | 4.13 | 4.13 | C-5-3 |
| PDM-21-500Q-1 | 1 | 760 | (2) 500 kcmil-#4 Awg | (1) 1/2-13 x 1-5/16 | - | Lug | Stud | - | 3.17 | 5.50 | 3.12 | - | 4.75 | 4.75 | C-6-1 |
| PDM-21-500Q-2 | 1 | 760 | (2) 500 kcmil-#4 Awg | (1) 1/2-13 x 1-5/16 | - | Lug | Stud | - | 5.85 | 5.50 | 3.12 | 2.69 | 4.75 | 4.75 | C-6-2 |
| PDM-21-500Q-3 | 1 | 760 | (2) 500 kcmil-#4 Awg | (1) 1/2-13 x 1-5/16 | - | Lug | Stud | - | 8.54 | 5.50 | 3.12 | 5.38 | 4.75 | 4.75 | C-6-3 |
| PDM-22-500N-1 | 1 | 760 | (2) 500 kcmil-#4 Awg | (2) 3/8-16 x 1-5/16 | 1.160 | Lug | Stud | - | 3.17 | 5.50 | 3.12 | - | 4.75 | 4.75 | C-6-1 |
| PDM-22-500N-2 | 1 | 760 | (2) 500 kcmil-#4 Awg | (2) 3/8-16 x 1-5/16 | 1.160 | Lug | Stud | - | 5.85 | 5.50 | 3.12 | 2.69 | 4.75 | 4.75 | C-6-2 |
| PDM-22-500N-3 | 1 | 760 | (2) 500 kcmil-#4 Awg | (2) 3/8-16 x 1-5/16 | 1.160 | Lug | Stud | - | 8.54 | 5.50 | 3.12 | 5.38 | 4.75 | 4.75 | C-6-3 |
| PDMN-11-2A-1 | 2 | 115 | (1) #2-#14 Awg | (1) 10-32 x .60 | - | Lug | Stud | - | 0.83 | 2.29 | 1.53 | - | 2.07 | 2.07 | CVR-2-1 |
| PDMN-11-2A-2 | 2 | 115 | (1) #2-#14 Awg | (1) 10-32 x .60 | - | Lug | Stud | - | 1.46 | 2.29 | 1.53 | - | 2.07 | 2.07 | CVR-2-2 |
| PDMN-11-2A-3 | 2 | 115 | (1) #2-#14 Awg | (1) 10-32 x .60 | - | Lug | Stud | - | 2.10 | 2.29 | 1.53 | 1.27 | 2.07 | 2.07 | CVR-2-3 |
| PDMN-11-2A-4 | 2 | 115 | (1) #2-#14 Awg | (1) 10-32 x .60 | - | Lug | Stud | - | 2.75 | 2.29 | 1.53 | 1.93 | 2.07 | 2.07 | CVR-2-4 |
| PDM-11-2/0T-A†* | 2 | 175 | (1) 2/0-#14 Awg | (1) M6 x 13 | - | Lug | Metric | - | 1.00 | 3.00 | 2.42 | - | 2.25 | - | NA |
| PDM-11-2/0T-1‡ | 2 | 175 | (1) 2/0-#14 Awg | (1) M6 x 13 | - | Lug | Metric | - | 1.00 | 3.00 | 2.42 | - | 2.25 | 2.57 | W/C |
| PDM-11-2/0T-2‡ | 2 | 175 | (1) 2/0-#14 Awg | (1) M6 x 13 | - | Lug | Metric | - | 1.82 | 3.00 | 2.42 | 0.81 | 2.25 | 2.57 | W/C |
| PDM-11-2/0T-3‡ | 2 | 175 | (1) 2/0-#14 Awg | (1) M6 x 13 | - | Lug | Metric | - | 2.55 | 3.00 | 2.42 | 1.63 | 2.25 | 2.57 | W/C |
| PDM-11-2/0B-A* | 2 | 175 | (1) 2/0-#14 Awg | (1) 1/4-20 x 1/2 | - | Lug | Stud | 100KA | 1.00 | 3.00 | 2.42 | - | 2.25 | - | NA |
| PDM-11-2/0B-1 | 2 | 175 | (1) 2/0-#14 Awg | (1) 1/4-20 x 1/2 | - | Lug | Stud | 100KA | 1.00 | 3.00 | 2.42 | - | 2.25 | 2.57 | W/C |
| PDM-11-2/0B-2 | 2 | 175 | (1) 2/0-#14 Awg | (1) 1/4-20 x 1/2 | - | Lug | Stud | 100KA | 1.82 | 3.00 | 2.42 | 0.81 | 2.25 | 2.57 | W/C |
| PDM-11-2/0B-3 | 2 | 175 | (1) 2/0-#14 Awg | (1) 1/4-20 x 1/2 | - | Lug | Stud | 100KA | 2.55 | 3.00 | 2.42 | 1.63 | 2.25 | 2.57 | W/C |

All wire sizes, unless noted otherwise, are American Wire Gauge (AWG) For further details on conductor classes please refer to product data sheets
UL1059 terminal block standard file No. E84782 CSA certified CSA c22.2 No. 158, File number MC 249467 (wire classes B & C only)

* Cover not available for adder blocks
W/C supplied with cover ‡ Steel Stud

Power Distribution Block

RoHS
Compliant



TYPE PDM

Features

- Connector, high conductive aluminium, tin plated
- Brass, tin plated stud
- UL Recognized 75° C/167° F and CSA Certified
- Insulator base adders available
- Panel Mountable
- Rated for 600 volts

Benefits

- Rated for copper and aluminum conductor
- Intended for wires terminated with crimp lugs
- Ensures Reliability
- Easily snap together to create variable pole power blocks

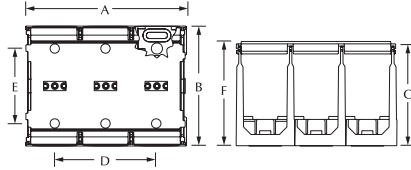
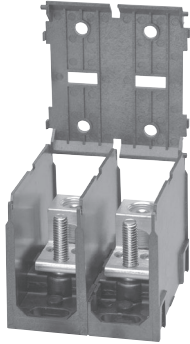

| Catalog Number | Amps | Rated Conductor Range | | Stud Ctr to Ctr | Line In | Line Out | Max A/C | Dimensions (in.) | | | | | | Cover ID |
|----------------|------|-----------------------|--------------------|-----------------|---------|----------|---------|------------------|------|------|------|------|-----------|----------|
| | | Line | Load | | | | | A | B | C | D | E | F w/cover | |
| PDM-11-350S-1 | 310 | (1) 350 kcmil-#6 Awg | (1) M10 x 30 | - | Lug | Metric | - | 1.96 | 4.00 | 3.33 | - | 3.38 | 3.49 | W/C |
| PDM-11-350S-2 | 310 | (1) 350 kcmil-#6 Awg | (1) M10 x 30 | - | Lug | Metric | - | 3.66 | 4.00 | 3.33 | 1.70 | 3.38 | 3.49 | W/C |
| PDM-11-350S-3 | 310 | (1) 350 kcmil-#6 Awg | (1) M10 x 30 | - | Lug | Metric | - | 5.36 | 4.00 | 3.33 | 3.40 | 3.38 | 3.49 | W/C |
| PDM-11-350M-1 | 310 | (1) 350 kcmil-#6 Awg | (1) 3/8-16 x 1-1/4 | - | Lug | Stud | 65KA | 1.96 | 4.00 | 3.33 | - | 3.38 | 3.49 | W/C |
| PDM-11-350M-2 | 310 | (1) 350 kcmil-#6 Awg | (1) 3/8-16 x 1-1/4 | - | Lug | Stud | 65KA | 3.66 | 4.00 | 3.33 | 1.70 | 3.38 | 3.49 | W/C |
| PDM-11-350M-3 | 310 | (1) 350 kcmil-#6 Awg | (1) 3/8-16 x 1-1/4 | - | Lug | Stud | 65KA | 5.36 | 4.00 | 3.33 | 3.40 | 3.38 | 3.49 | W/C |
| PDM-18-S2-1 | 510 | (1) M10 x 30 | (8) #2-#14 Awg | - | Metric | Lug | - | 1.96 | 4.00 | 3.33 | - | 3.38 | 3.49 | W/C |
| PDM-18-S2-2 | 510 | (1) M10 x 30 | (8) #2-#14 Awg | - | Metric | Lug | - | 3.66 | 4.00 | 3.33 | 1.70 | 3.38 | 3.49 | W/C |
| PDM-18-S2-3 | 510 | (1) M10 x 30 | (8) #2-#14 Awg | - | Metric | Lug | - | 5.36 | 4.00 | 3.33 | 3.40 | 3.38 | 3.49 | W/C |
| PDM-112-S4-1 | 510 | (1) M10 x 30 | (12) #4-#14 Awg | - | Metric | Lug | - | 1.96 | 4.00 | 3.33 | - | 3.38 | 3.49 | W/C |
| PDM-112-S4-2 | 510 | (1) M10 x 30 | (12) #4-#14 Awg | - | Metric | Lug | - | 3.66 | 4.00 | 3.33 | 1.70 | 3.38 | 3.49 | W/C |
| PDM-112-S4-3 | 510 | (1) M10 x 30 | (12) #4-#14 Awg | - | Metric | Lug | - | 5.36 | 4.00 | 3.33 | 3.40 | 3.38 | 3.49 | W/C |
| PDM-14-S2/0-1 | 510 | (1) M10 x 30 | (4) 2/0-#14 Awg | - | Metric | Lug | - | 1.96 | 4.00 | 3.33 | - | 3.38 | 3.49 | W/C |
| PDM-14-S2/0-2 | 510 | (1) M10 x 30 | (4) 2/0-#14 Awg | - | Metric | Lug | - | 3.66 | 4.00 | 3.33 | 1.70 | 3.38 | 3.49 | W/C |
| PDM-14-S2/0-3 | 510 | (1) M10 x 30 | (4) 2/0-#14 Awg | - | Metric | Lug | - | 5.36 | 4.00 | 3.33 | 3.40 | 3.38 | 3.49 | W/C |
| PDM-18-K2-1 | 510 | (1) 3/8-16 x 1-3/16 | (8) #2-#14 Awg | - | Stud | Lug | - | 1.96 | 4.00 | 3.33 | - | 3.38 | 3.49 | W/C |
| PDM-18-K2-2 | 510 | (1) 3/8-16 x 1-3/16 | (8) #2-#14 Awg | - | Stud | Lug | - | 3.66 | 4.00 | 3.33 | 1.70 | 3.38 | 3.49 | W/C |
| PDM-18-K2-3 | 510 | (1) 3/8-16 x 1-3/16 | (8) #2-#14 Awg | - | Stud | Lug | - | 5.36 | 4.00 | 3.33 | 3.40 | 3.38 | 3.49 | W/C |
| PDM-112-K4-1 | 510 | (1) 3/8-16 x 1-3/16 | (12) #4-#14 Awg | - | Stud | Lug | - | 1.96 | 4.00 | 3.33 | - | 3.38 | 3.49 | W/C |
| PDM-112-K4-2 | 510 | (1) 3/8-16 x 1-3/16 | (12) #4-#14 Awg | - | Stud | Lug | - | 3.66 | 4.00 | 3.33 | 1.70 | 3.38 | 3.49 | W/C |
| PDM-112-K4-3 | 510 | (1) 3/8-16 x 1-3/16 | (12) #4-#14 Awg | - | Stud | Lug | - | 5.36 | 4.00 | 3.33 | 3.40 | 3.38 | 3.49 | W/C |
| PDM-14-K2/0-1 | 510 | (1) 3/8-16 x 1-3/16 | (4) 2/0-#14 Awg | - | Stud | Lug | - | 1.96 | 4.00 | 3.33 | - | 3.38 | 3.49 | W/C |
| PDM-14-K2/0-2 | 510 | (1) 3/8-16 x 1-3/16 | (4) 2/0-#14 Awg | - | Stud | Lug | - | 3.66 | 4.00 | 3.33 | 1.70 | 3.38 | 3.49 | W/C |
| PDM-14-K2/0-3 | 510 | (1) 3/8-16 x 1-3/16 | (4) 2/0-#14 Awg | - | Stud | Lug | - | 5.36 | 4.00 | 3.33 | 3.40 | 3.38 | 3.49 | W/C |

All wire sizes, unless noted otherwise, are American Wire Gauge (AWG)

For further details on conductor classes please refer to product data sheets

UL1059 terminal block standard file No. E84782 CSA certified CSA c22.2 No. 158, File number MC 249467 (wire classes B & C only)

W/C supplied with cover



nVent ILSCO Snaploc

Power Distribution Blocks

Modular Design - Dual Rated



TYPE
LDAU
LDBU

Features

- Modular design
- Easy to assemble
- UL listed 90° C/194° F 600 Volts
- Electro-tin plated aluminum
- Multiple conductor capability

Benefits

- Simplifies stocking. Combines any number of blocks with multiple conductor ranges into the specific configuration required for the job.
- Unique locking feature allows individual blocks to be combined quickly without special tools
- Ensures reliability
- Suitable for use with both copper and aluminum conductors in any combination
- Individual blocks supplied in a variety of configurations with one or two main cable ports and four, six, or twelve taps. All are range taking.



Fig. 1

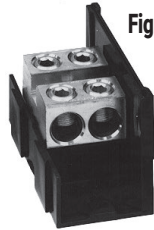

Fig. 2

F

| Catalog Number | Fig. No. | Connector | | Primary | | | Secondary | | | Ampere Rating Per Pole |
|----------------|----------|-----------|-----------|------------|-------------------|----------|------------|-------------------|----------|------------------------|
| | | Primary | Secondary | Wire Range | Openings Per Pole | Hex Size | Wire Range | Openings Per Pole | Hex Size | |
| LDBU-112-350 | 1 | | | 350kcmil-6 | 1 | 3/8 | 4-14 | 12 | Slot | 310 |
| LDAU-112-350 | 2 | | | 350kcmil-6 | 1 | 3/8 | 4-14 | 12 | Slot | 310 |
| DBU-112A-350 | 1 | | | 350kcmil-6 | 1 | 3/8 | 4-14 | 12 | Slot | 310 |
| LDAU-112A-350 | 2 | | | 350kcmil-6 | 1 | 3/8 | 4-14 | 12 | Slot | 310 |
| LDBU-16-350 | 1 | | | 350kcmil-6 | 1 | 3/8 | 2/0-14 | 6 | Slot | 310 |
| LDAU-16-350 | 2 | | | 350kcmil-6 | 1 | 3/8 | 2/0-14 | 6 | Slot | 310 |
| LDBU-16-500 | 1 | | | 500kcmil-4 | 1 | 3/8 | 2/0-14 | 6 | Slot | 380 |
| LDAU-16-500 | 2 | | | 500kcmil-4 | 1 | 3/8 | 2/0-14 | 6 | Slot | 380 |
| LDBU-26-350 | 1 | | | 350kcmil-6 | 2 | 3/8 | 2/0-14 | 6 | Slot | 620 |
| LDAU-26-350 | 2 | | | 350kcmil-6 | 2 | 3/8 | 2/0-14 | 6 | Slot | 620 |
| LDBU-212-4/0 | 1 | | | 4/0-6 | 2 | 3/8 | 4-14 | 12 | Slot | 460 |
| LDAU-212-4/0 | 2 | | | 4/0-6 | 2 | 3/8 | 4-14 | 12 | Slot | 460 |
| LDBU-212-500 | 1 | | | 500kcmil-4 | 2 | 3/8 | 4-14 | 12 | Slot | 760 |
| LDAU-212-500 | 2 | | | 500kcmil-4 | 2 | 3/8 | 4-14 | 12 | Slot | 760 |
| LDBU-26-500 | 1 | | | 500kcmil-4 | 2 | 3/8 | 2/0-14 | 6 | 3/16 | 760 |
| LDAU-26-500 | 2 | | | 500kcmil-4 | 2 | 3/8 | 2/0-14 | 6 | 3/16 | 760 |
| LDBU-24-500 | 1 | | | 500kcmil-4 | 2 | 3/8 | 4/0-6 | 4 | 5/16 | 760 |
| LDAU-24-500 | 2 | | | 500kcmil-4 | 2 | 3/8 | 4/0-6 | 4 | 5/16 | 760 |
| LDBU-11-500 | 1 | | | 500kcmil-4 | 1 | 3/8 | 500kcmil-4 | 4 | 3/8 | 380 |
| LDAU-11-500 | 2 | | | 500kcmil-4 | 1 | 3/8 | 500kcmil-4 | 4 | 3/8 | 380 |
| LDBU-22-350 | 1 | | | 350kcmil-6 | 2 | 3/8 | 350kcmil-6 | 2 | 3/8 | 620 |
| LDAU-22-350 | 2 | | | 350kcmil-6 | 2 | 3/8 | 350kcmil-6 | 2 | 3/8 | 620 |
| LDBU-22-500 | 1 | | | 500kcmil-4 | 2 | 3/8 | 500kcmil-4 | 2 | 3/8 | 760 |
| LDAU-22-500 | 2 | | | 500kcmil-4 | 2 | 3/8 | 500kcmil-4 | 2 | 3/8 | 760 |

Side Panel can be ordered separately Cat. No. LDS-1

All wire sizes, unless noted otherwise, are American Wire Gauge (AWG)
Tested to UL 1953, UL File E112158

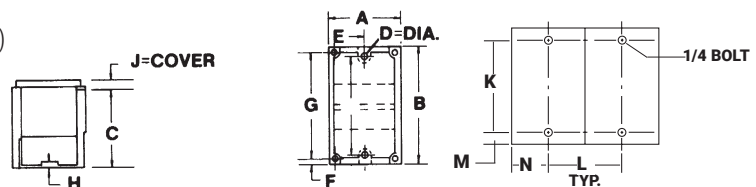

| Dimensions (in.) | | | | | | | | | | | | | |
|------------------|-------|--------|----------|-------|------|-------|-----|---------|------|------|-----|------|--|
| A | B | C | D=Dia. | E | F | G | H | J=Cover | K | L | M | N | |
| 3 | 5-1/2 | 3-7/16 | .28 Slot | 1-1/2 | 5/16 | 4-7/8 | 1/4 | 1/2 | 4.75 | 2.69 | .38 | 1.50 | |

Type Power Distribution Blocks

Lay-In - Dual Rated



TYPE PDBU

Features

- Lay-In primary cable ports
- Valox insulating base
- UL 1953 Listed for 600 volts
- Electro-tin plated
- Manufactured from high strength aluminum

Benefits

- Designed for feed through of two primary conductors and up to six taps with no need to break the main feeder cable
- Provides a high degree of impact resistance with superior insulating qualities
- Ensures reliability
- Provides low contact resistance
- Suitable for use with either copper or aluminum conductors

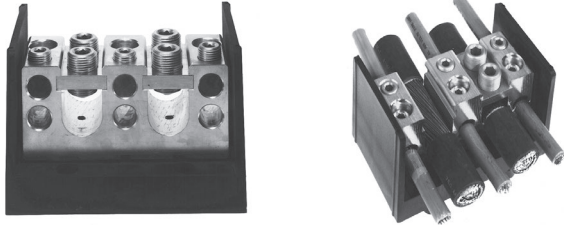

| Catalog Number | Connector | | Primary | | Secondary | | Ampere Rating Per Pole | No. of Poles | Hex Size | |
|----------------|-----------|-----------|-------------------|-------------------|------------|-------------------|------------------------|--------------|----------|-----------|
| | Primary | Secondary | Wire Range | Openings Per Pole | Wire Range | Openings Per Pole | | | Primary | Secondary |
| PDBU-26-750-1 | | | 750kcmil-250kcmil | 2 | 250kcmil-6 | 6 | 950 | 1 | 3/8 | 1/4 |

All wire sizes, unless noted otherwise, are American Wire Gauge (AWG)
Tested to UL 1953, UL File E112158

F

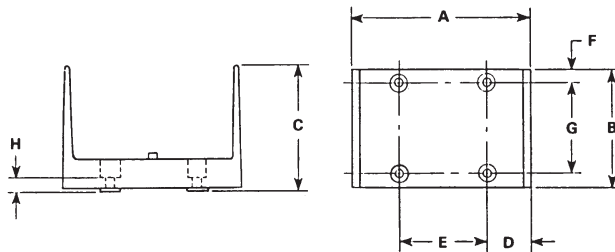

| Block Size | No. of Poles | Dimensions (in.) | | | | | | | |
|------------|--------------|------------------|---|-------|---------|---|-----|-------|------|
| | | A | B | C | D | E | F | G | H |
| W | 1 | 6-7/32 | 4 | 4-3/8 | 1-19/32 | 3 | 3/8 | 3-1/4 | 7/16 |

* Valox is a registered trade name of the General Electric Company.

Power Distribution Block

Copper Only

RoHS
Compliant



TYPE
PDBU

Features

- Manufactured from high strength aluminum
- Valox* insulating base
- UL 1953 Listed 90° C/194° F 600 volts
- Electro-tin plated

Benefits

- Reliable use for copper conductor only
- Provides a high degree of impact resistance with superior insulating qualities
- Ensures reliability
- Provides low contact resistance



F

| Catalog Number | Connector | | Primary | | Secondary | | Ampere Rating Per Pole | No. of Poles | Block Size | Hex Size | |
|----------------|-----------|-----------|-------------------|-------------------|-------------------|-------------------|------------------------|--------------|------------|----------|-----------|
| | Primary | Secondary | Wire Range | Openings Per Pole | Wire Range | Openings Per Pole | | | | Primary | Secondary |
| PDBU-55-600-1 | | | 600kcmil-250kcmil | 5 | 600kcmil-250kcmil | 5 | 1900 | 1 | W | 3/8 | 3/8 |

All wire sizes, unless noted otherwise, are American Wire Gauge (AWG)
 Valox is a registered trade name of the General Electric Company.
 A versatile tap hole, wire range 8-14 AWG included on the connector.
 Tested to UL 1953, UL File E112158

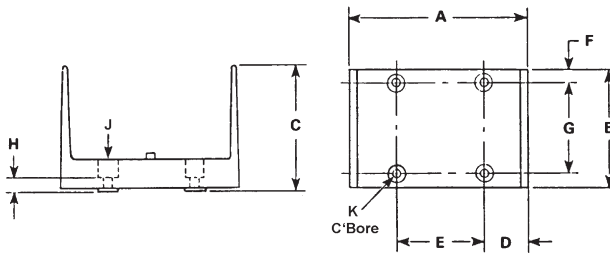

| Block Size | No. of Poles | Dimensions (in.) | | | | | | | | | |
|------------|--------------|------------------|---|-------|---------|---|-----|-------|------|------|------|
| | | A | B | C | D | E | F | G | H | J | K |
| W | 1 | 6-7/32 | 4 | 4-3/8 | 1-19/32 | 3 | 3/8 | 3-1/4 | 7/16 | 9/32 | 9/16 |

Power Distribution Blocks

Dual Rated



TYPE PDBU

Features

- Multiple taps
- Valox* insulating base
- UL 1953 Listed 90° C/194° F 600 Volts
- Electro-tin plated
- Manufactured from high strength aluminum
- Short Circuit Rating 10K RMS SYM Amps

Benefits

- Three different connector configurations provide a wide range of tapping capabilities for up to four primary conductors
- Provides a high degree of impact resistance with superior insulating qualities
- Ensures reliability
- Provides low contact resistance
- Suitable for use with either copper or aluminum conductors
- Added protection



Fig. 1

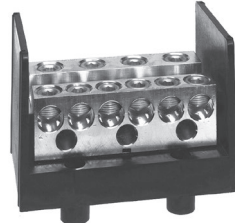

Fig. 2



Fig. 3



Fig. 4

| Catalog Number | Figure No. | Connector | | Primary | | Secondary | | Ampere Rating Per Pole | No. of Poles | Block Size | Hex Size | |
|----------------|------------|-----------|-----------|--------------|-------------------|---------------------|-------------------|------------------------|--------------|------------|----------|-------------|
| | | Primary | Secondary | Wire Range | Openings Per Pole | Wire Range | Openings Per Pole | | | | Primary | Secondary |
| PDBU-428-500-1 | 1 | | | 500kcmil-4 | 4 | 4-14 | 28 | 1520 | 1 | W | 3/8 | Slot |
| PDBU-49-500-1 | 2 | | | 500kcmil-4 | 4 | 350kcmil-6 4/0-6 | 6 3 | 1520 | 1 | W | 3/8 | 3/8 5/16 |
| PDBU-55-500-1 | 4 | | | 500kcmil-3/0 | 5 | 500kcmil-3/0 | 5 | 1600 | 1 | W | 3/8 | 3/8 |
| PDBU-412-500-1 | 3 | | | 500kcmil-4 | 4 | 4/0-6 | 12 | 1520 | 1 | W | 3/8 | 5/16 |



All wire sizes, unless noted otherwise, are American Wire Gauge (AWG)
 Valox is a registered trade name of the General Electric Company.
 ° A versatile tap hole, wire range 8-14 AWG included on the connector.

Tested to UL 1953, UL File E112158

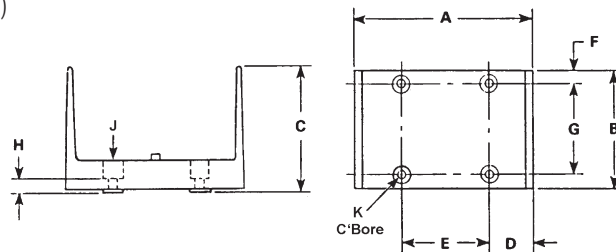

| Block Size | No. of Poles | Dimensions (in.) | | | | | | | | | |
|------------|--------------|------------------|---|-------|---------|---|-----|-------|------|------|------|
| | | A | B | C | D | E | F | G | H | J | K |
| W | 1 | 6-7/32 | 4 | 4-3/8 | 1-19/32 | 3 | 3/8 | 3-1/4 | 7/16 | 9/32 | 9/16 |

Snapbloc

Power Distribution Blocks

Modular Design - Dual Rated

RoHS
Compliant



TYPE
LDA
LDB

Features

- Modular design
- Easy to assemble
- UL Recognized 90° C/194° F 600 Volts and is CSA Certified
- Electro-tin plated aluminum
- Clear cover included
- Multiple conductor capability

Benefits

- Simplifies stocking. Combines any number of blocks with multiple conductor ranges into the specific configuration required for the job.
- Unique locking feature allows individual blocks to be combined quickly without special tools
- Ensures reliability
- Suitable for use with both copper and aluminum conductors in any combination
- Permits visual inspection
- Individual blocks supplied in a variety of configurations with one or two main cable ports and four, six, or twelve taps. All are range taking.



Fig. 1

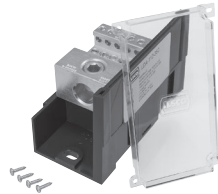

Fig. 2

F

| Catalog Number | Fig. No. | Connector | | Primary | | | Secondary | | | Ampere Rating Per Pole |
|----------------|----------|-----------|-----------|------------|-------------------|----------|------------|-------------------|----------|------------------------|
| | | Primary | Secondary | Wire Range | Openings Per Pole | Hex Size | Wire Range | Openings Per Pole | Hex Size | |
| LDB-112-350 | 1 | | | 350kcmil-6 | 1 | 3/8 | 4-14 | 12 | Slot | 310 |
| LDA-112-350 | 2 | | | 350kcmil-6 | 1 | 3/8 | 4-14 | 12 | Slot | 310 |
| LDB-112A-350 | 1 | | | 350kcmil-6 | 1 | 3/8 | 4-14 | 12 | Slot | 310 |
| LDA-112A-350 | 2 | | | 350kcmil-6 | 1 | 3/8 | 4-14 | 12 | Slot | 310 |
| LDB-16-350 | 1 | | | 350kcmil-6 | 1 | 3/8 | 2/0-14 | 6 | 3/16 | 310 |
| LDA-16-350 | 2 | | | 350kcmil-6 | 1 | 3/8 | 2/0-14 | 6 | 3/16 | 310 |
| LDB-16-500 | 1 | | | 500kcmil-4 | 1 | 3/8 | 2/0-14 | 6 | 3/16 | 380 |
| LDA-16-500 | 2 | | | 500kcmil-4 | 1 | 3/8 | 2/0-14 | 6 | 3/16 | 380 |
| LDB-26-350 | 1 | | | 350kcmil-6 | 2 | 3/8 | 2/0-14 | 6 | 3/16 | 620 |
| LDA-26-350 | 2 | | | 350kcmil-6 | 2 | 3/8 | 2/0-14 | 6 | 3/16 | 620 |
| LDB-212-4/0 | 1 | | | 4/0-6 | 2 | 1/4 | 4-14 | 12 | Slot | 460 |
| LDA-212-4/0 | 2 | | | 4/0-6 | 2 | 1/4 | 4-14 | 12 | Slot | 460 |
| LDB-212-500 | 1 | | | 500kcmil-4 | 2 | 3/8 | 4-14 | 12 | Slot | 760 |
| LDA-212-500 | 2 | | | 500kcmil-4 | 2 | 3/8 | 4-14 | 12 | Slot | 760 |
| LDB-26-500 | 1 | | | 500kcmil-4 | 2 | 3/8 | 2/0-14 | 6 | 3/16 | 760 |
| LDA-26-500 | 2 | | | 500kcmil-4 | 2 | 3/8 | 2/0-14 | 6 | 3/16 | 760 |
| LDB-24-500 | 1 | | | 500kcmil-4 | 2 | 3/8 | 4/0-6 | 4 | 5/16 | 760 |
| LDA-24-500 | 2 | | | 500kcmil-4 | 2 | 3/8 | 4/0-6 | 4 | 5/16 | 760 |
| LDB-11-500 | 1 | | | 500kcmil-4 | 1 | 3/8 | 500kcmil-4 | 1 | 3/8 | 380 |
| LDA-11-500 | 2 | | | 500kcmil-4 | 1 | 3/8 | 500kcmil-4 | 1 | 3/8 | 380 |
| LDB-22-350 | 1 | | | 350kcmil-6 | 2 | 3/8 | 350kcmil-6 | 2 | 3/8 | 620 |
| LDA-22-350 | 2 | | | 350kcmil-6 | 2 | 3/8 | 350kcmil-6 | 2 | 3/8 | 620 |
| LDB-22-500 | 1 | | | 500kcmil-4 | 2 | 3/8 | 500kcmil-4 | 2 | 3/8 | 760 |
| LDA-22-500 | 2 | | | 500kcmil-4 | 2 | 3/8 | 500kcmil-4 | 2 | 3/8 | 760 |

Side Panel can be ordered separately Cat. No. LDS-1

All wire sizes, unless noted otherwise, are American Wire Gauge (AWG)

Tested to UL 1059, UL File E84782

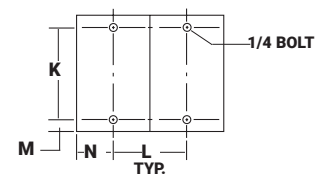
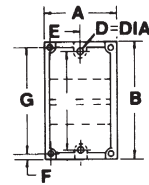
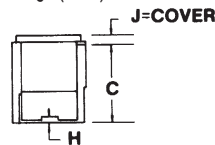

| Dimensions (in.) | | | | | | | | | | | | | |
|------------------|-------|--------|----------|-------|------|-------|-----|---------|------|------|-----|------|--|
| A | B | C | D=Dia. | E | F | G | H | J=Cover | K | L | M | N | |
| 3 | 5-1/2 | 3-7/16 | .28 Slot | 1-1/2 | 5/16 | 4-7/8 | 1/4 | 1/2 | 4.75 | 2.69 | .38 | 1.50 | |

Modular Type

Power Distribution Blocks

Dual Rated

RoHS
Compliant



TYPE
PDA
PDC

Features

- Modular design
- Easy to assemble
- UL Recognized 90° C/194° F 600 Volts and is CSA Certified
- Electro-tin plated
- Lexan* insulating base
- Manufactured from high strength aluminum

Benefits

- Simplifies stocking. Combines any number of blocks with multiple conductor ranges into the specific configuration required for the job.
- Unique locking feature allows individual blocks to be combined quickly without special tools
- Ensures reliability
- Provides low contact resistance
- Provides a high degree of impact resistance with superior insulating qualities
- Suitable for use with either copper or aluminum conductors



Fig. 1



Fig. 2



Fig. 3

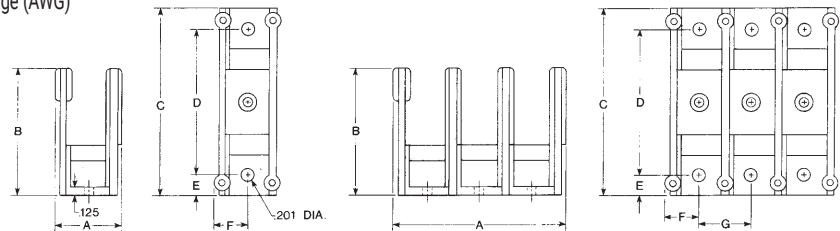

Fig. 4

| Catalog Number | Figure No. | Connector | | Primary | | Secondary | | Ampere Rating Per Pole | No. of Poles | Hex Size | |
|----------------|------------|-----------|-----------|------------|-------------------|------------|-------------------|------------------------|--------------|----------|-----------|
| | | Primary | Secondary | Wire Range | Openings Per Pole | Wire Range | Openings Per Pole | | | Primary | Secondary |
| PDC-14-2/0-1 | 1 | | | 2/0-14 | 1 | 4-14 | 4 | 175 | 1 | 3/16 | Slot |
| PDA-14-2/0-1 | 2 | | | 2/0-14 | 1 | 4-14 | 4 | 175 | Adder | 3/16 | Slot |
| PDC-11-2/0-1 | 3 | | | 2/0-14 | 1 | 2/0-14 | 1 | 175 | 1 | 3/16 | 3/16 |
| PDA-11-2/0-1 | 4 | | | 2/0-14 | 1 | 2/0-14 | 1 | 175 | Adder | 3/16 | 3/16 |



All wire sizes, unless noted otherwise, are American Wire Gauge (AWG)
Covers available 1-10 Poles. Specify length.
*Lexan is a registered trademark of SABIC INNOVATIVE PLASTICS HOLDINGS BV.
Tested to UL 1059, UL File E84782



| Block Size | No. of Poles | Dimensions (in.) | | | | | | |
|------------|--------------|------------------|------|------|------|-----|-----|-----|
| | | A | B | C | D | E | F | G |
| S | 1 | 1.05 | 1.94 | 2.88 | 2.25 | .31 | .53 | .80 |
| S | 2 | 1.85 | 1.94 | 2.88 | 2.25 | .31 | .53 | .80 |

A Dimension increases by .80 per additional pole.

| Covers Poles 1-6 | | |
|------------------|---------|--------------|
| R1835A00A | PDA/PDC | 1 Pole Cover |
| R1834A00A | PDA/PDC | 2 Pole Cover |
| R1480A00A | PDA/PDC | 3 Pole Cover |
| R1836A00A | PDA/PDC | 4 Pole Cover |
| R2281A00A | PDA/PDC | 6 Pole Cover |

Power Distribution Blocks

Dual Rated

RoHS
Compliant



TYPE PDB

Features

- Range taking
- Valox[®] insulating base
- Electro-tin plated
- Manufactured from high strength aluminum
- UL Recognized rated 90° C/194° F and is CSA Certified, rated for 600 volts

Benefits

- Provides great flexibility in using the connector as an in line splice or to reduce conductor size
- Provides a high degree of impact resistance with superior insulating qualities
- Provides low contact resistance
- Suitable for use with either copper or aluminum conductors
- Ensures reliability

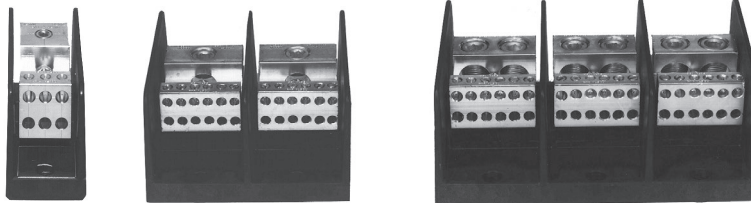

F

| Catalog Number | Connector | | Primary | | Secondary | | Ampere Rating Per Pole | No. of Poles | Block Size | Hex Size | |
|----------------|-----------|-----------|------------|-------------------|------------|-------------------|------------------------|--------------|------------|----------|-----------|
| | Primary | Secondary | Wire Range | Openings Per Pole | Wire Range | Openings Per Pole | | | | Primary | Secondary |
| PDB-16-2/0-1 | | | 2/0-12 | 1 | 4-14 | 6 | 175 | 1 | M | | |
| PDB-16-2/0-2 | | | 2/0-12 | 1 | 4-14 | 6 | 175 | 2 | M | 3/16 | Slot |
| PDB-16-2/0-3 | | | 2/0-12 | 1 | 4-14 | 6 | 175 | 3 | M | | |
| PDB-26-2/0-1 | | | 2/0-12 | 2 | 2-14 | 6 | 350 | 1 | M | | |
| PDB-26-2/0-2 | | | 2/0-12 | 2 | 2-14 | 6 | 350 | 2 | M | 3/16 | Slot |
| PDB-26-2/0-3 | | | 2/0-12 | 2 | 2-14 | 6 | 350 | 3 | M | | |
| PDB-112-350-1 | | | 350kcmil-6 | 1 | 4-14 | 12 | 310 | 1 | L | | |
| PDB-112-350-2 | | | 350kcmil-6 | 1 | 4-14 | 12 | 310 | 2 | L | 3/8 | Slot |
| PDB-112-350-3 | | | 350kcmil-6 | 1 | 4-14 | 12 | 310 | 3 | L | | |
| PDB-112A-350-1 | | | 350kcmil-6 | 1 | 4-14 | 12 | 310 | 1 | M | | |
| PDB-112A-350-2 | | | 350kcmil-6 | 1 | 4-14 | 12 | 310 | 2 | M | 3/8 | Slot |
| PDB-112A-350-3 | | | 350kcmil-6 | 1 | 4-14 | 12 | 310 | 3 | M | | |
| PDB-14-500-1 | | | 500kcmil-4 | 1 | 2/0-14 | 4 | 380 | 1 | M | | |
| PDB-14-500-2 | | | 500kcmil-4 | 1 | 2/0-14 | 4 | 380 | 2 | M | 3/8 | 3/16 |
| PDB-14-500-3 | | | 500kcmil-4 | 1 | 2/0-14 | 4 | 380 | 3 | M | | |
| PDB-16-350-1 | | | 350kcmil-6 | 1 | 2/0-14 | 6 | 310 | 1 | L | | |
| PDB-16-350-2 | | | 350kcmil-6 | 1 | 2/0-14 | 6 | 310 | 2 | L | 3/8 | 3/16 |
| PDB-16-350-3 | | | 350kcmil-6 | 1 | 2/0-14 | 6 | 310 | 3 | L | | |
| PDB-162-500-1 | | | 500kcmil-4 | 1 | 2-14 | 6 | 380 | 1 | M | | |
| PDB-162-500-2 | | | 500kcmil-4 | 1 | 2-14 | 6 | 380 | 2 | M | 3/8 | Slot |
| PDB-162-500-3 | | | 500kcmil-4 | 1 | 2-14 | 6 | 380 | 3 | M | | |

All wire sizes, unless noted otherwise, are American Wire Gauge (AWG)

* Valox is a registered trade name of the General Electric Company.

Tested to UL 1059, UL File E84782

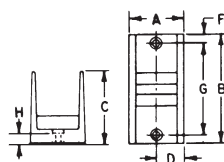

Fig. 1

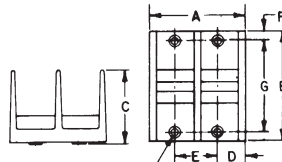

Fig. 2

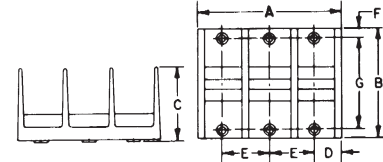

Fig. 3

| Block Size | No. of Poles | Fig. No. | Dimensions (in.) | | | | | | | | | |
|------------|--------------|----------|------------------|-------|-------|-------|---------|------|-------|------|-------|-------|
| | | | A | B | C | D | E | F | G | H | J | K |
| M | 1 | 1 | 1-27/32 | 4 | 2-5/8 | 31/32 | - | 5/16 | 3-3/8 | 3/8 | 13/64 | 13/32 |
| M | 2 | 2 | 3-13/32 | 4 | 2-5/8 | 31/32 | 1-17/32 | 5/16 | 3-3/8 | 3/8 | 13/64 | 13/32 |
| M | 3 | 3 | 5 | 4 | 2-5/8 | 31/32 | 1-17/32 | 5/16 | 3-3/8 | 3/8 | 13/64 | 13/32 |
| L | 1 | 1 | 3 | 5-1/2 | 3-1/2 | 1-1/2 | - | 3/8 | 4-3/4 | 7/16 | 9/32 | 1/2 |
| L | 2 | 2 | 5-11/16 | 5-1/2 | 3-1/2 | 1-1/2 | 2-11/16 | 3/8 | 4-3/4 | 7/16 | 9/32 | 1/2 |
| L | 3 | 3 | 8-3/8 | 5-1/2 | 3-1/2 | 1-1/2 | 2-11/16 | 3/8 | 4-3/4 | 7/16 | 9/32 | 1/2 |

Power Distribution Blocks

Dual Rated

RoHS
Compliant



TYPE PDB

Features

- Range taking
- Valox* insulating base
- Electro-tin plated
- Manufactured from high strength aluminum
- UL Recognized rated 90° C/194° F and is CSA Certified, rated for 600 volts

Benefits

- Provides great flexibility in using the connector as an in line splice or to reduce conductor size
- Provides a high degree of impact resistance with superior insulating qualities
- Provides low contact resistance
- Suitable for use with either copper or aluminum conductors
- Ensures reliability

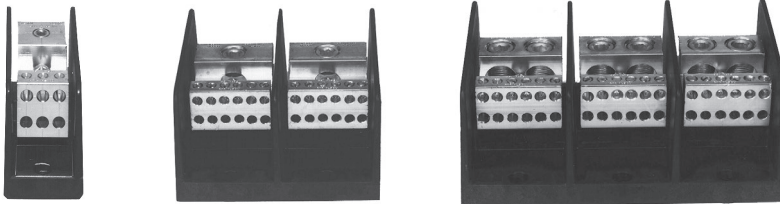

| Catalog Number | Connector | | Primary | | Secondary | | Ampere Rating Per Pole | No. of Poles | Block Size | Hex Size | |
|----------------|-----------|-----------|------------|-------------------|------------|-------------------|------------------------|--------------|------------|----------|-----------|
| | Primary | Secondary | Wire Range | Openings Per Pole | Wire Range | Openings Per Pole | | | | Primary | Secondary |
| PDB-212-4/0-1 | | | 4/0-6 | 2 | 4-14 | 12 | 460 | 1 | M | 3/8 | Slot |
| PDB-212-4/0-2 | | | 4/0-6 | 2 | 4-14 | 12 | 460 | 2 | M | 3/8 | Slot |
| PDB-212-4/0-3 | | | 4/0-6 | 2 | 4-14 | 12 | 460 | 3 | M | 3/8 | Slot |
| PDB-26-350-1 | | | 350kcmil-6 | 2 | 2/0-14 | 6 | 620 | 1 | L | 3/8 | 3/16 |
| PDB-26-350-2 | | | 350kcmil-6 | 2 | 2/0-14 | 6 | 620 | 2 | L | 3/8 | 3/16 |
| PDB-26-350-3 | | | 350kcmil-6 | 2 | 2/0-14 | 6 | 620 | 3 | L | 3/8 | 3/16 |
| PDB-16-500-1 | | | 500kcmil-4 | 1 | 2/0-14 | 6 | 380 | 1 | L | 3/8 | 3/16 |
| PDB-16-500-2 | | | 500kcmil-4 | 1 | 2/0-14 | 6 | 380 | 2 | L | 3/8 | 3/16 |
| PDB-16-500-3 | | | 500kcmil-4 | 1 | 2/0-14 | 6 | 380 | 3 | L | 3/8 | 3/16 |
| PDB-212-500-1 | | | 500kcmil-4 | 2 | 4-14 | 12 | 760 | 1 | L | 3/8 | Slot |
| PDB-212-500-2 | | | 500kcmil-4 | 2 | 4-14 | 12 | 760 | 2 | L | 3/8 | Slot |
| PDB-212-500-3 | | | 500kcmil-4 | 2 | 4-14 | 12 | 760 | 3 | L | 3/8 | Slot |
| PDB-24-500-1 | | | 500kcmil-4 | 2 | 4/0-6 | 4 | 760 | 1 | L | 3/8 | 5/16 |
| PDB-24-500-2 | | | 500kcmil-4 | 2 | 4/0-6 | 4 | 760 | 2 | L | 3/8 | 5/16 |
| PDB-24-500-3 | | | 500kcmil-4 | 2 | 4/0-6 | 4 | 760 | 3 | L | 3/8 | 5/16 |
| PDB-26-500-2 | | | 500kcmil-4 | 2 | 2/0-14 | 6 | 760 | 1 | L | 3/8 | 3/16 |
| PDB-26-500-1 | | | 500kcmil-4 | 2 | 2/0-14 | 6 | 760 | 2 | L | 3/8 | 3/16 |
| PDB-26-500-3 | | | 500kcmil-4 | 2 | 2/0-14 | 6 | 760 | 3 | L | 3/8 | 3/16 |



All wire sizes, unless noted otherwise, are American Wire Gauge (AWG)

* Valox is a registered trade name of the General Electric Company.

Tested to UL 1059, UL File E84782

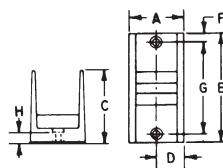

Fig. 1

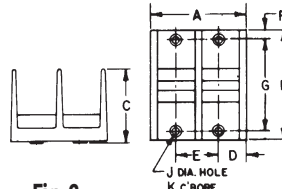

Fig. 2

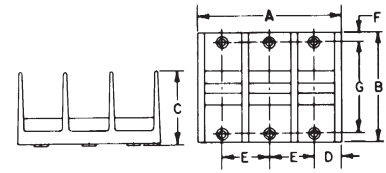

Fig. 3

| Block Size | No. of Poles | Fig. No. | Dimensions (in.) | | | | | | | | | |
|------------|--------------|----------|------------------|-------|-------|-------|---------|------|-------|------|-------|-------|
| | | | A | B | C | D | E | F | G | H | J | K |
| M | 1 | 1 | 1-27/32 | 4 | 2-5/8 | 31/32 | - | 5/16 | 3-3/8 | 3/8 | 13/64 | 13/32 |
| M | 2 | 2 | 3-13/32 | 4 | 2-5/8 | 31/32 | 1-17/32 | 5/16 | 3-3/8 | 3/8 | 13/64 | 13/32 |
| M | 3 | 3 | 5 | 4 | 2-5/8 | 31/32 | 1-17/32 | 5/16 | 3-3/8 | 3/8 | 13/64 | 13/32 |
| L | 1 | 1 | 3 | 5-1/2 | 3-1/2 | 1-1/2 | - | 3/8 | 4-3/4 | 7/16 | 9/32 | 1/2 |
| L | 2 | 2 | 5-11/16 | 5-1/2 | 3-1/2 | 1-1/2 | 2-11/16 | 3/8 | 4-3/4 | 7/16 | 9/32 | 1/2 |
| L | 3 | 3 | 8-3/8 | 5-1/2 | 3-1/2 | 1-1/2 | 2-11/16 | 3/8 | 4-3/4 | 7/16 | 9/32 | 1/2 |

Power Distribution Blocks

Dual Rated

RoHS
Compliant



TYPE PDB

Features

- Multiple taps
- Range taking
- Valox* insulating base
- Electro-tin plated
- Manufactured from high strength aluminum
- UL Recognized rated 90° C/194° F and is CSA Certified, rated for 600 volts

Benefits

- Depending on product selected, up to twelve taps can be taken from one or two mains
- Provides tapping flexibility over a broad wire range
- Provides a high degree of impact resistance with superior insulating qualities
- Provides low contact resistance
- Suitable for use with either copper or aluminum conductors
- Ensures reliability

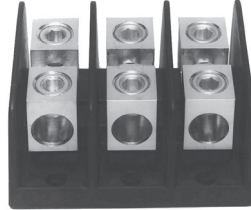

F

| Catalog Number | Connector | | Primary | | Secondary | | Ampere Rating Per Pole | No. of Poles | Block Size | Hex Size | |
|----------------|-----------|-----------|------------|-------------------|------------|-------------------|------------------------|--------------|------------|----------|-----------|
| | Primary | Secondary | Wire Range | Openings Per Pole | Wire Range | Openings Per Pole | | | | Primary | Secondary |
| PDB-11-2/0-1 | | | 2/0-14 | 1 | 2/0-14 | 1 | 175 | 1 | M | 3/16 | 3/16 |
| PDB-11-2/0-2 | | | 2/0-14 | 1 | 2/0-14 | 1 | 175 | 2 | M | | |
| PDB-11-2/0-3 | | | 2/0-14 | 1 | 2/0-14 | 1 | 175 | 3 | M | | |
| PDB-11-350-1 | | | 350kcmil-6 | 1 | 350kcmil-6 | 1 | 310 | 1 | M | 3/8 | 3/8 |
| PDB-11-350-2 | | | 350kcmil-6 | 1 | 350kcmil-6 | 1 | 310 | 2 | M | | |
| PDB-11-350-3 | | | 350kcmil-6 | 1 | 350kcmil-6 | 1 | 310 | 3 | M | | |
| PDB-11-500-1 | | | 500kcmil-4 | 1 | 500kcmil-4 | 1 | 380 | 1 | L | 3/8 | 3/8 |
| PDB-11-500-2 | | | 500kcmil-4 | 1 | 500kcmil-4 | 1 | 380 | 2 | L | | |
| PDB-11-500-3 | | | 500kcmil-4 | 1 | 500kcmil-4 | 1 | 380 | 3 | L | | |
| PDB-22-2/0-1 | | | 2/0-14 | 2 | 2/0-14 | 2 | 350 | 1 | M | 3/16 | 3/16 |
| PDB-22-2/0-2 | | | 2/0-14 | 2 | 2/0-14 | 2 | 350 | 2 | M | | |
| PDB-22-2/0-3 | | | 2/0-14 | 2 | 2/0-14 | 2 | 350 | 3 | M | | |
| PDB-22-350-1 | | | 350kcmil-6 | 2 | 350kcmil-6 | 2 | 620 | 1 | L | 3/8 | 3/8 |
| PDB-22-350-2 | | | 350kcmil-6 | 2 | 350kcmil-6 | 2 | 620 | 2 | L | | |
| PDB-22-350-3 | | | 350kcmil-6 | 2 | 350kcmil-6 | 2 | 620 | 3 | L | | |
| PDB-22-500-1 | | | 500kcmil-4 | 2 | 500kcmil-4 | 2 | 760 | 1 | L | 3/8 | 3/8 |
| PDB-22-500-2 | | | 500kcmil-4 | 2 | 500kcmil-4 | 2 | 760 | 2 | L | | |
| PDB-22-500-3 | | | 500kcmil-4 | 2 | 500kcmil-4 | 2 | 760 | 3 | L | | |

All wire sizes, unless noted otherwise, are American Wire Gauge (AWG)

* Valox is a registered trade name of the General Electric Company.

Tested to UL 1059, UL File E84782

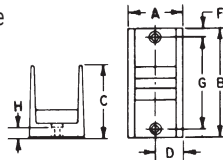

Fig. 1

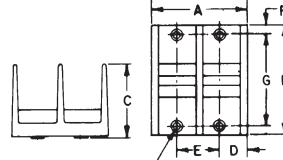

Fig. 2

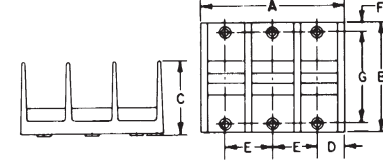

Fig. 3

| Block Size | No. of Poles | Fig. No. | Dimensions (in.) | | | | | | | | | |
|------------|--------------|----------|------------------|-------|-------|-------|---------|------|-------|------|-------|-------|
| | | | A | B | C | D | E | F | G | H | J | K |
| M | 1 | 1 | 1-27/32 | 4 | 2-5/8 | 31/32 | - | 5/16 | 3-3/8 | 3/8 | 13/64 | 13/32 |
| M | 2 | 2 | 3-13/32 | 4 | 2-5/8 | 31/32 | 1-17/32 | 5/16 | 3-3/8 | 3/8 | 13/64 | 13/32 |
| M | 3 | 3 | 5 | 4 | 2-5/8 | 31/32 | 1-17/32 | 5/16 | 3-3/8 | 3/8 | 13/64 | 13/32 |
| L | 1 | 1 | 3 | 5-1/2 | 3-1/2 | 1-1/2 | - | 3/8 | 4-3/4 | 7/16 | 9/32 | 1/2 |
| L | 2 | 2 | 5-11/16 | 5-1/2 | 3-1/2 | 1-1/2 | 2-11/16 | 3/8 | 4-3/4 | 7/16 | 9/32 | 1/2 |
| L | 3 | 3 | 8-3/8 | 5-1/2 | 3-1/2 | 1-1/2 | 2-11/16 | 3/8 | 4-3/4 | 7/16 | 9/32 | 1/2 |

Power Distribution Blocks

Lay-In Type - Dual Rated

RoHS
Compliant



TYPE PDB

Features

- Lay-In primary cable ports
- Valox insulating base
- Clear cover
- UL 1059 Recognized and CSA Certified for 600 volts
- Electro-tin plated
- Manufactured from high strength aluminum

Benefits

- Designed for feed through of two primary conductors and up to six taps with no need to break the main feeder cable
- Provides a high degree of impact resistance with superior insulating qualities
- Permits visual inspection
- Ensures reliability
- Provides low contact resistance
- Suitable for use with either copper or aluminum conductors

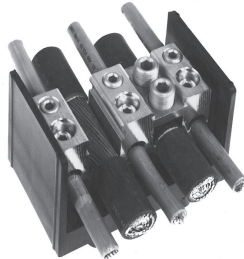
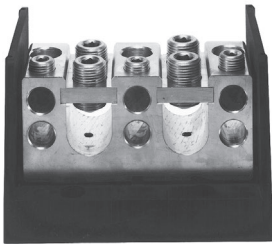

| Catalog Number | Connector | | Primary | | Secondary | | Ampere Rating Per Pole | No. of Poles | Hex Size | |
|----------------|-----------|-----------|-------------------|-------------------|------------|-------------------|------------------------|--------------|----------|-----------|
| | Primary | Secondary | Wire Range | Openings Per Pole | Wire Range | Openings Per Pole | | | Primary | Secondary |
| PDB-26-750-1 | | | 750kcmil-250kcmil | 2 | 250kcmil-6 | 6 | 950 | 1 | 3/8 | 1/4 |



All wire sizes, unless noted otherwise, are American Wire Gauge (AWG)
Tested to UL 1059, UL File E84782

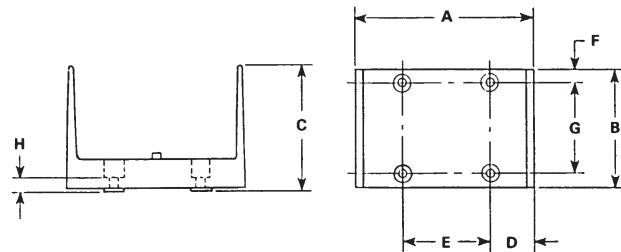

| Block Size | No. of Poles | Dimensions (in.) | | | | | | | |
|------------|--------------|------------------|---|-------|---------|---|-----|-------|------|
| | | A | B | C | D | E | F | G | H |
| W | 1 | 6-7/32 | 4 | 4-3/8 | 1-19/32 | 3 | 3/8 | 3-1/4 | 7/16 |

* Valox is a registered trade name of the General Electric Company.

Power Distribution Block

Copper Only

RoHS
Compliant



TYPE
PDB

Features

- Manufactured from high strength aluminum
- Valox* insulating base
- UL 1059 Recognized 90° C/194° F 600 volts
- Electro-tin plated
- Clear cover

Benefits

- Reliable use for copper conductor only
- Provides a high degree of impact resistance with superior insulating qualities
- Ensures reliability
- Provides low contact resistance
- Provides visual inspection



F

| Catalog Number | Connector | | Primary | | Secondary | | Ampere Rating Per Pole | No. of Poles | Block Size | Hex Size | |
|----------------|-----------|-----------|-------------------|-------------------|-------------------|-------------------|------------------------|--------------|------------|----------|-----------|
| | Primary | Secondary | Wire Range | Openings Per Pole | Wire Range | Openings Per Pole | | | | Primary | Secondary |
| ‡ PDB-55-600-1 | | | 600kcmil-250kcmil | 5 | 600kcmil-250kcmil | 5 | 1900 | 1 | W | 3/8 | 3/8 |

All wire sizes, unless noted otherwise, are American Wire Gauge (AWG)

Valox is a registered trade name of the General Electric Company.

A versatile tap hole, wire range 8-14 AWG included on the connector.

Tested to UL 1059, UL File E84782

‡ Not CSA Certified

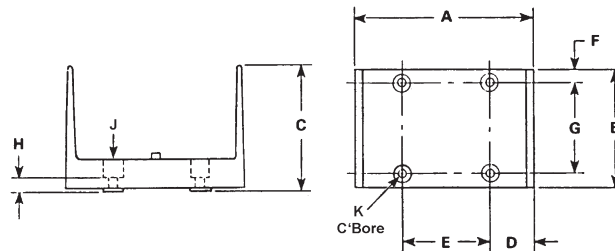

| Block Size | No. of Poles | Dimensions (in.) | | | | | | | | | |
|------------|--------------|------------------|---|-------|---------|---|-----|-------|------|------|------|
| | | A | B | C | D | E | F | G | H | J | K |
| W | 1 | 6-7/32 | 4 | 4-3/8 | 1-19/32 | 3 | 3/8 | 3-1/4 | 7/16 | 9/32 | 9/16 |

Power Distribution Blocks

Dual Rated

RoHS
Compliant



TYPE PDB

Features

- Multiple taps
- Valox* insulating base
- Clear cover
- UL 1059 Recognized 90° C/194° F 600 Volts and is CSA Certified
- Electro-tin plated
- Manufactured from high strength aluminum

Benefits

- Three different connector configurations provide a wide range of tapping capabilities for up to four primary conductors
- Provides a high degree of impact resistance with superior insulating qualities
- Permits visual inspection
- Ensures reliability
- Provides low contact resistance
- Suitable for use with either copper or aluminum conductors

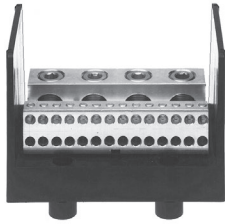

Fig. 1

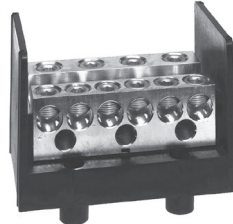

Fig. 2

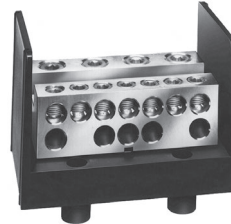

Fig. 3



Fig. 4

| Catalog Number | Fig. No. | Connector | | Primary | | Secondary | | Ampere Rating Per Pole | No. of Poles | Block Size | Hex Size | |
|----------------|----------|-----------|-----------|--------------|-------------------|---------------------|-------------------|------------------------|--------------|------------|----------|-----------|
| | | Primary | Secondary | Wire Range | Openings Per Pole | Wire Range | Openings Per Pole | | | | Primary | Secondary |
| PDB-428-500-1 | 1 | | | 500kcmil-4 | 4 | 4-14 | 28 | 1520 | 1 | W | 3/8 | Slot |
| PDB-49-500-1 | 2 | | | 500kcmil-4 | 4 | 350kcmil-6 4/0-6 | 6 | 1520 | 1 | W | 3/8 | 3/8 |
| ‡PDB-55-500-1 | 4 | | | 500kcmil-3/0 | 5 | 500kcmil-3/0 | 5 | 1600 | 1 | W | 3/8 | 3/8 |
| PDB-412-500-1 | 3 | | | 500kcmil-4 | 4 | 4/0-6 | 12 | 1520 | 1 | W | 3/8 | 5/16 |



All wire sizes, unless noted otherwise, are American Wire Gauge (AWG)

Valox is a registered trade name of the General Electric Company.

° A versatile tap hole, wire range 8-14 AWG included on the connector.

‡ Not CSA Certified

Tested to UL 1059, UL File E84782

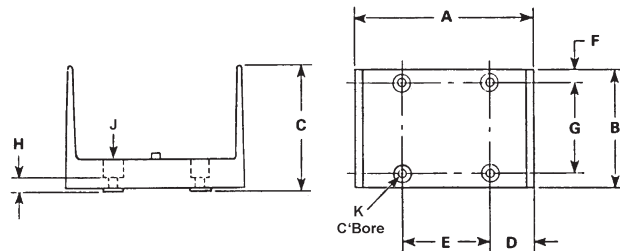

| Block Size | No. of Poles | Dimensions (in.) | | | | | | | | | |
|------------|--------------|------------------|---|-------|---------|---|-----|-------|------|------|------|
| | | A | B | C | D | E | F | G | H | J | K |
| W | 1 | 6-7/32 | 4 | 4-3/8 | 1-19/32 | 3 | 3/8 | 3-1/8 | 7/16 | 9/32 | 9/16 |

Grounding

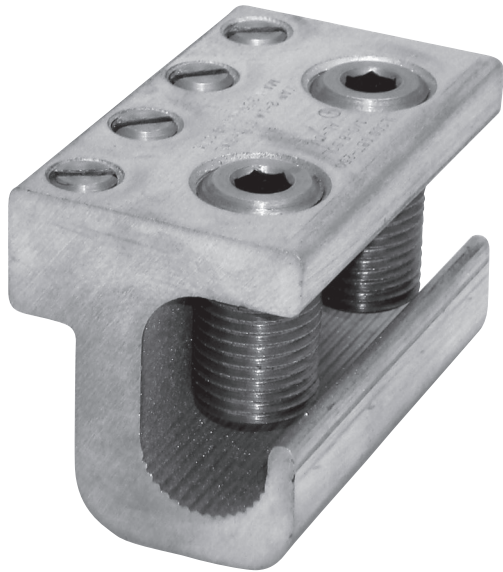

**nVent ILSCO ClearGround
Intersystem Ground Tap
Type GBT**

GGB

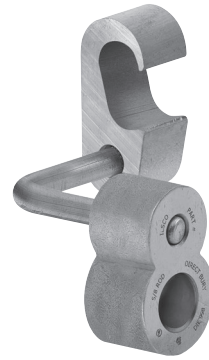

268 - 270

CGP

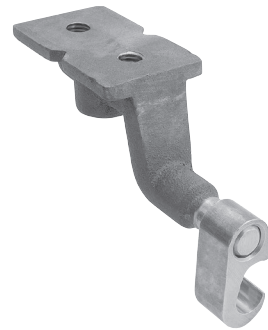

271

SPS



275 - 276

RLT



272 - 274

SPD



277 - 278

TTGC



279

GPL



280 - 281

GS



282

D167



283

CAN



284

N-174



284

SGB



285

GBL

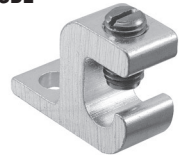

286

GRM



287

GRF



287

GH, GHS



288

GMS, GWL

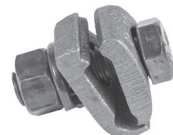

289

GO

















290

GR

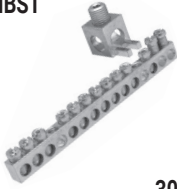

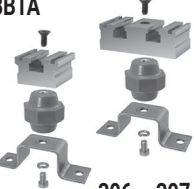
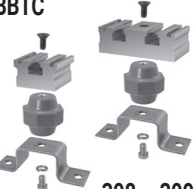
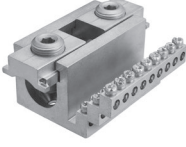
291

Grounding

| | | | | | |
|-----------------------------------------------------------------------------------------------------------------|----------------------------------------------------------------------------------------------------------------------|---------------------------------------------------------------------------------------------------------------------|------------------------------------------------------------------------------------------------------------------------|-------------------------------------------------------------------------------------------------------------------------|-------------------------------------------------------------------------------------------------------------------------|
| <p>GT</p>  <p>292</p> | <p>GSE, HGSE</p>  <p>293</p> | <p>GU</p>  <p>294 - 295</p> | <p>LS, LSN</p>  <p>296</p> | <p>NB</p>  <p>297</p> | <p>NBAS</p>  <p>298</p> |
| <p>NBAE</p>  <p>299</p> | <p>NBCE</p>  <p>300</p> | <p>NBST</p>  <p>301</p> | <p>BBFC</p>  <p>302 - 305</p> | <p>BBTA</p>  <p>306 - 307</p> | <p>BBTC</p>  <p>308 - 309</p> |
| <p>SCNL</p>  <p>310</p> | <p>SCNM</p>  <p>311</p> | <p>SBW</p>  <p>312</p> | <p>SBC</p>  <p>313</p> | <p>SBJ</p>  <p>314</p> | |

Grounding Grid System

- Pure wrought copper extrusions prevent corrosion due to dissimilar metals, have the same conductivity as copper conductors, and are pre-filled with inhibiting compound

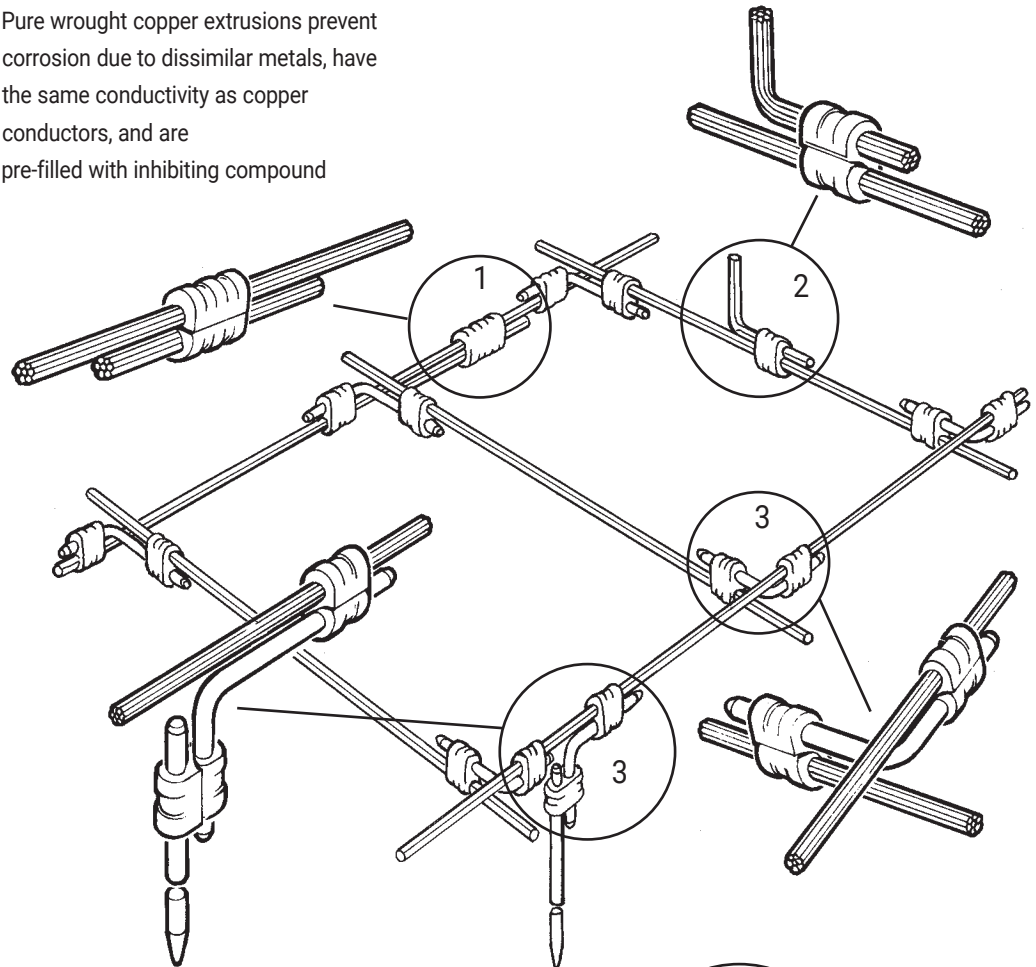

- 1 ULT
Compression Line Tap/C-Crimp
Applications: Tap Connector, Lap Splice Connector
Conductor Range: #6 solid – 4/0

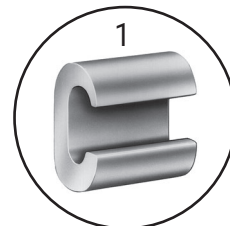

- 2 GGC
Compression Ground Tap Connector
Applications: Tap Connector, Lap Splice Connector
Conductor Range: #6 solid – 500kcmil
Copper Ground Rods: 1/2 in, 5/8 in, 3/4 in



- 3 GGA
Compression Ground Grid Cross Connector
Compression elements can be rotated or adjusted prior to installation
Applications: Cross Connector, Ground Rod Connector
Conductor Range: #6 solid – 500kcmil
Copper Ground Rods: 1/2 in, 5/8 in, 3/4 in

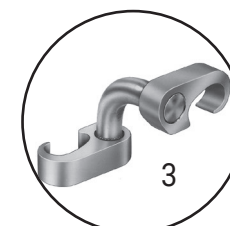

Compression Grounding

Figure 6 - 8 Grounding Grid



TYPE GGB

Features

- Manufactured from high strength copper alloy
- Clearly marked with wire size and die index
- Each size accepts a wide range of cable sizes
- Side 1 & Side 2 can be rotated to any position before crimping
- UL Listed and CSA Certified for grounding and bonding
- Prefilled with De-Ox oxide inhibiting compound
- TN in catalog number designates tin plated

Benefits

- Provides maximum conductivity
- Provides easy identification and tooling recommendation
- Application flexibility and reduced inventory
- Ease of installation
- Direct burial in earth or concrete
- Prevents oxides from forming
- For use with galvanized steel ground rod

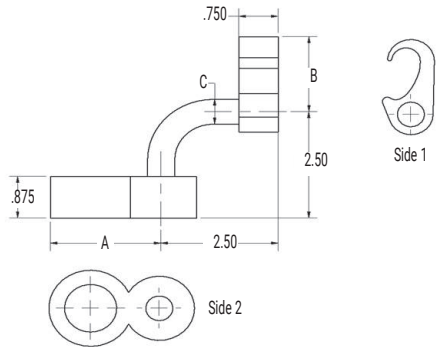

| Catalog Number | Commercial Copper Cable Range Side 1 | Metric Copper Cable Range Side 1 | Copper Weld Cable Range Side 1 | Ground Rod Dia. Side 2 | Rebar Side 2 | Dimensions - in. (mm) | | |
|----------------|------------------------------------------------|--------------------------------------------------------------------------|----------------------------------------------------|------------------------|--------------|-----------------------|--------------|-------------|
| | | | | | | A | B | C |
| GGB-5 | 500kcmil (.813 dia.) thru 250kcmil (.575 dia.) | 240mm ² (20.35mm dia.) thru 120mm ² (14.40mm dia.) | 498.8kcmil (.810 dia.) thru 248.8kcmil (.572 dia.) | 1/2 in | #3 | 1.390 (35.3) | 2.075 (52.7) | 0.312 (7.9) |
| GGB-6 | 500kcmil (.813 dia.) thru 250kcmil (.575 dia.) | 240mm ² (20.35mm dia.) thru 120mm ² (14.40mm dia.) | 498.8kcmil (.810 dia.) thru 248.8kcmil (.572 dia.) | 5/8 in | #4 | 1.455 (37.0) | 2.075 (52.7) | 0.312 (7.9) |
| GGB-6TN | 500kcmil (.813 dia.) thru 250kcmil (.575 dia.) | 240mm ² (20.35mm dia.) thru 120mm ² (14.40mm dia.) | 498.8kcmil (.810 dia.) thru 248.8kcmil (.572 dia.) | 5/8 in | N/A | 1.455 (37.0) | 2.075 (52.7) | 0.312 (7.9) |



All wire sizes, unless noted otherwise, are American Wire Gauge (AWG)
Tested to UL467, UL File E34440

Notes:

1. When used with ground rods, it is recommended to rough up the end of ground rod where GGB is to be placed. This provides good rotational resistance. **Perform a "pre-crimp" on ground rod prior to installing GGB connector. Use an indent type of die such as ILD-Precrimp.**

Compression Grounding

Figure 6 - 8 Grounding Grid

Tooling



TYPE GGB

Features

- Manufactured from high strength copper alloy
- Clearly marked with wire size and die index
- Each size accepts a wide range of cable sizes
- Side 1 & Side 2 can be rotated to any position before crimping
- UL Listed and CSA Certified for grounding and bonding
- Prefilled with De-Ox oxide inhibiting compound
- TN in catalog number designates tin plated

Benefits

- Provides maximum conductivity
- Provides easy identification and tooling recommendation
- Application flexibility and reduced inventory
- Ease of installation
- Direct burial in earth or concrete
- Prevents oxides from forming
- For use with galvanized steel ground rod

| Catalog Number | Installation Tooling | | | | | |
|----------------|------------------------------------------------------------------------------------------------------------|---------|----------------------------------------------------------------|---------|-----------------------------------------------------------------|---------|
| | nVent ILSCO | | Burndy | | Thomas & Betts (w/Burndy Dies) | |
| | ILC-12-N, ILC-12H-N, ILCB-12-N, & ILC-15 Series ‡ TB-12U1000-P, TM-12U1000, TR-12U1000 Die (No. of Crimps) | | Y35, Y39, Y46, Y750, PAT750 & PAT46 Series Die (No. of Crimps) | | TBM14, TBM15, BPLT14 & BPLT15 Series, 1300A Die (No. of Crimps) | |
| | Side 1 | Side 2 | Side 1 | Side 2 | Side 1 | Side 2 |
| GGB-5 | 998 (1) | 998 (1) | 998 (1) | 998 (1) | 998 (1) | 998 (1) |
| GGB-6 | 998 (1) | 998 (1) | 998 (1) | 998 (1) | 998 (1) | 998 (1) |
| GGB-6TN | 998 (1) | 998 (1) | 998 (1) | 998 (1) | 998 (1) | 998 (1) |

G

997 and 998 are Burndy die indexes

‡ Adaptor required when using ILC-15 Series tools

INFORMATION SHEET GGB SERIES

Grounding and Bonding Equipment
 Compression Connectors for Copper Conductors
 Suitable for Direct Burial in Earth or Concrete



UTILCO
 connections - matter

OUTLINE FOR DIRECT BURIAL IN EARTH OR CONCRETE



| Catalog Number | Cu Ground Rod Size | Side A | | Copper Wire Size | Installation Tools | | | | | | |
|----------------|--------------------|------------|----------------------------------|-----------------------|----------------------|----------------------|----------------------|----------------------|----------------------|----------------------|----------------------|
| | | Rebar Size | Galvanized Steel Ground Rod Size | | UTILCO | Rigid | Greenlee | Thomas & Betts | Burdry | | |
| | | | | | Die Index (# Crimps) | Die Index (# Crimps) | Die Index (# Crimps) | Die Index (# Crimps) | Die Index (# Crimps) | Die Index (# Crimps) | Die Index (# Crimps) |
| GGB-1 | 1/2" | #3 | - | 2 - 250 kcmil | 998 (1) | 997 (1) | 998 (1) | 997 (1) | 998 (1) | 997 (1) | 997 (1) |
| GGB-2 | 5/8" | #4 | - | 2 - 250 kcmil | 998 (1) | 997 (1) | 998 (1) | 997 (1) | 998 (1) | 997 (1) | 997 (1) |
| GGB-3 | 3/4" | #5 | - | 2 - 250 kcmil | 998 (1) | 997 (1) | 998 (1) | 997 (1) | 998 (1) | 997 (1) | 997 (1) |
| GGB-3TN | - | - | 3/4" | 2 - 250 kcmil | 998 (1) | 997 (1) | 998 (1) | 997 (1) | 998 (1) | 997 (1) | 997 (1) |
| GGB-4 | 1" | #6 - 7 | - | 2 - 250 kcmil | 998 (1) | 997 (1) | N/A | 997 (1) | 998 (1) | 997 (1) | N/A |
| GGB-5 | 1/2" | #3 | - | 250 kcmil - 500 kcmil | 998 (1) | 998 (1) | 998 (1) | N/A | 998 (1) | 998 (1) | N/A |
| GGB-6 | 5/8" | #4 | - | 250 kcmil - 500 kcmil | 998 (1) | 998 (1) | 998 (1) | N/A | 998 (1) | 998 (1) | N/A |
| GGB-6TN | - | - | 5/8" | 250 kcmil - 500 kcmil | 998 (1) | 998 (1) | 998 (1) | N/A | 998 (1) | 998 (1) | N/A |
| GGB-7 | 3/4" | #5 | - | 250 kcmil - 500 kcmil | 998 (1) | 998 (1) | 998 (1) | N/A | 998 (1) | 998 (1) | N/A |
| GGB-8 | 1" | #6 - 7 | - | 250 kcmil - 500 kcmil | 998 (1) | 998 (1) | N/A | N/A | 998 (1) | 998 (1) | N/A |

GGB Series compression ground grid cross connector can be used to connect a copper ground grid system together or to connect a copper ground grid system to a copper clad ground rod. They allow adjustment of each side of the connector prior to installation. They are pre-filled with inhibiting compound and are suitable for direct burial.

- Notes:
1. Either ILSCO or Burndy Type U and P Dies can be used to install this product.
 2. ILSCO and Burndy Type U-dies are designed to be used in crimping tools that apply at least 12-tons of pressure. Crimping ILSCO connectors with U-type dies in tools with less than 12-tons of pressure results in connections that do not meet ILSCO's design requirements for the system. Tools with less than 12-tons of pressure should not be used with U-type dies.
 3. Adapter is required when using ILSCO ILC-15, Greenlee RK1550, Thomas & Betts TBM15, BPL T15, Burndy Y45, Y46 or PAT46 crimp tools.
 4. When used with ground rod/rebar, it is recommended to rough up the end of ground rod/rebar where GGB is to be placed. This provides good rotational resistance. Perform a "pre-crimp" on ground rod/rebar prior to installing GGB connector. Use an indent type of die such as ILSCO's ILD-PRECRIMP, Burndy's U2CABT (Die Index # 348) or UPRECRIMP-12, -58, -34.*
 5. Each side of the GGB Series may be rotated around the ground rod/rebar to any desired position before crimping.
 6. GGB - TN Series are specifically designed to be used to with Galvanized Steel Ground Rod.

* "U2CABT" and "UPRECRIMP" are registered trademarks TM of Burndy/FCI.

Compression Grounding Grounding Plate



MEETS
IEEE
837 REQUIREMENTS

TYPE CGP

Features

- Cast copper alloy body
- Available in two and four hole NEMA spacing
- Underside tapped hole
- Pre-filled with De-Ox Oxide Inhibitor
- UL Listed for grounding and bonding

Benefits

- High strength, high conductivity
- Industry standard
- Ease of positioning
- Direct burial in earth or concrete

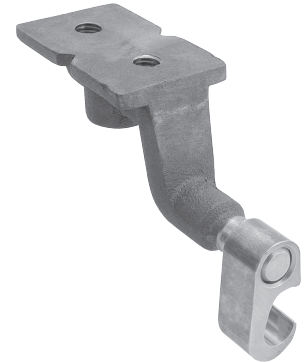
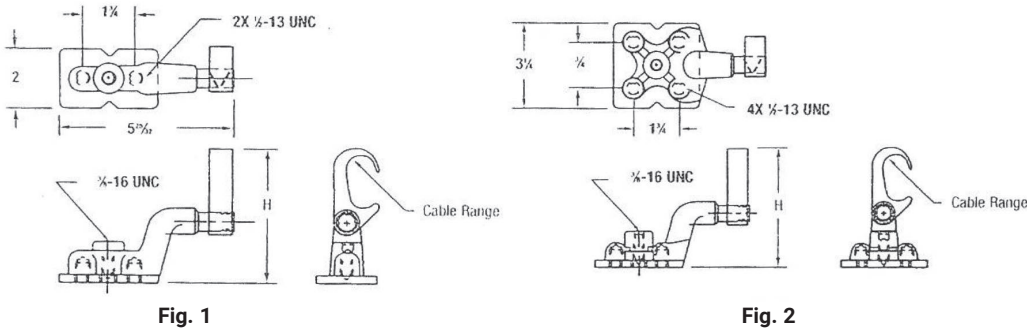

| Catalog Number | Figure Number | Cable Range | H - in (mm) | Dies |
|----------------|---------------|-------------------|--------------|----------|
| CGP2-250500 | 1 | 500kcmil-250kcmil | 3-5/8 (92.1) | *15G126R |

G

All wire sizes, unless noted otherwise, are American Wire Gauge (AWG)
*T&B Dies
UL File E158587

Tooling Information:

*T&B Dies can be used in the following Thomas & Betts tools:

- TBM14M
- TBM14MC
- TBM14BSCR
- BPLT14BSCR
- BPLT14BSCRI
- 13100A
- TBM15I

Grounding Connectors

For Copper Conductor Only



TYPE RLT

Features

- UL Listed and CSA certified for direct burial in earth or concrete
- Range taking
- Manufactured from high strength copper alloy
- Prefilled with De-Ox oxide inhibitor compound and bagged
- Clearly marked with wire size and die index

Benefits

- Ensures reliability
- Reduces inventory
- Provides maximum conductivity and eliminates the possibility of corrosion
- Prevents oxides from forming
- Provides easy identification and tooling recommendations

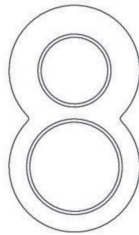
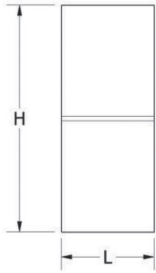

Fig. 1



Fig. 2



Fig. 3

| Catalog Number | Figure Number | Ground Rod Size | Wire Range | Die Index | Dimensions - in. (mm) | |
|----------------|---------------|-----------------|---------------------|-----------|-----------------------|--------------|
| | | | | | H | L |
| RLT-10 | 1 | 1 | 2/0 - 2 | 998/1011 | 2.440 (62.0) | 0.880 (22.4) |
| RLT-12 | 1 | 1 | 500kcmil - 300kcmil | 998/1011 | 2.680 (68.1) | 0.880 (22.4) |
| RLT-8TN* | 3 | 5/8 | 500kcmil - 300kcmil | 998/1011 | 2.142 (54.4) | 0.875 (22.2) |
| RLT-9TN* | 3 | 3/4 | 500kcmil - 300kcmil | 998/1011 | 2.432 (61.8) | 0.875 (22.2) |



All wire sizes, unless noted otherwise, are American Wire Gauge (AWG)

Tested to UL 467, UL File E34440

* All suffix "TN" parts electro-tin plated; to be specifically used with galvanized steel ground rod. The ground rod hole diameter is larger to suit galvanized steel.

Grounding Connectors

Tooling



TYPE RLT

Features

- UL Listed and CSA certified for direct burial in earth or concrete
- Range taking
- Manufactured from high strength copper alloy
- Prefilled with De-Ox oxide inhibitor compound and bagged
- Clearly marked with wire size and die index

Benefits

- Ensures reliability
- Reduces inventory
- Provides maximum conductivity and eliminates the possibility of corrosion
- Prevents oxides from forming
- Provides easy identification and tooling recommendations

| Catalog Number | nVent ILSCO | | | | Competitor's Tooling | | | | | | | | |
|----------------|-----------------------------------------------------|---------|-----------------------------|---------|-------------------------------------------|---------|-------------------------------------|---------|--------------------------------------------------------------------------------|---------|---------------------------------------|---------|----------|
| | Hydraulic Tools | | | | Burndy | | | | Thomas & Betts | | | | |
| | 12- Ton | | 15-Ton | | 12- Ton | | 15-Ton | | 12- Ton | | 15-Ton | | |
| | ILC-12-N, ILC-12H-N, ILCB-12-LIO (No. of Crimps) | | ILC-15-H (No. of Crimps) | | Y750, PAT750XT, Y750BH (No. of Crimps) | | Y46, Y46C, PAT46 (No. of Crimps) | | TBM14M, TBM14MC, TBM14BSCR, BPLT14BSCR, BPLT14BSCRI, 13100A (No. of Crimps) | | TBM15I, BPLT15BSCR (No. of Crimps) | | |
| Die 998 | Die 1011 | Die 998 | Die 1011 | Die 998 | Die 1011 | Die 998 | Die 1011 | Die 998 | Die 1011 | Die 998 | Die 1011 | Die 998 | Die 1011 |
| RLT-10 | (1) | | (1) | (2) | (1) | (2) | (1) | (2) | (1) | (2) | (1) | (2) | (2) |
| RLT-12 | (1) | - | - | (2) | (1) | (2) | - | (2) | (1) | (2) | (1) | (2) | (2) |
| RLT-8TN | (1) | - | (1) | (2) | (1) | (2) | (1) | (2) | (1) | (2) | (1) | (2) | (2) |
| RLT-9TN | (1) | - | (1) | (2) | (1) | (2) | (1) | (2) | (1) | (2) | (1) | (2) | (2) |

G

Notes:

1. The RLT Series of compression connectors are designed to connect a copper ground conductor to a copper clad ground rod.
2. The RLT Series of compression connectors are pre-filled with inhibiting compound and are suitable for direct burial.
3. It is recommended to rough up the end of the ground rod where RLT is to be placed. This provides good rotational resistance. Perform a "pre-crimp" on ground rod prior to installing RLT connector. Use an indent type of dies such as Burndy's U2CABT (Die Index #348) or UPRECRIMP-12, -58, -34.*
4. The RLT Series may be rotated around the rod to any desired position before crimping.

*"UPRECRIMP" and "U2CABT" are registered trademarks TM of Burndy/FCI

Bronze, Service Post Connectors

Single Conductor Type - Short Stud, Male

RoHS
Compliant

UL
LISTED
8M24

SA
AP-100973¹

TYPE
SPS

Features

- Range taking
- Re-usable
- UL 486A/B and UL 467 Listed
- For grounding of steel structures, fence posts and tapping cables from bus bar
- For copper to copper connections

Benefits

- Permits inventories to be kept to a minimum
- Provides efficient use and flexibility in the field
- Ensures reliability
- Flexibility in the field

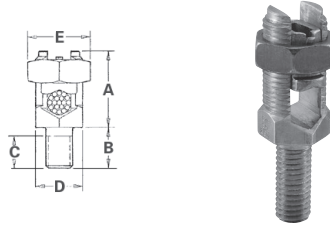

G

| Catalog Number | Conductor Range AWG MM ² | | | | Max Dia. Range | Stud Size | Dimensions (in.) | | | | |
|----------------|-------------------------------------|--------------------------|------------------------|------------------------|----------------|----------------|------------------|-------|-------|--------|---------|
| | Stranded | | Solid | | | | A | B | C | D | E |
| | Max. | Min. | Max. | Min. | | | | | | | |
| SPSS-0 | 8 | 12 (4mm ²) | 8 (10mm ²) | 12 (4mm ²) | .146-.080 | 1/4-20 x 1/2 | 11/16 | 1/2 | 23/64 | 15/32 | 1/2 |
| SPSS-1 | 7 (10mm ²) | 10 (6mm ²) | 6 (10mm ²) | 10 (6mm ²) | .170-.102 | 1/4-20 x 1/2 | 13/16 | 1/2 | 23/64 | 15/32 | 21/32 |
| SPSS-2 | 5 (16mm ²) | 10 (6mm ²) | 4 (16mm ²) | 10 (6mm ²) | .217-.102 | 5/16-18 x 5/8 | 15/16 | 5/8 | 25/64 | 17/32 | 23/32 |
| SPSS-3 | 3 (25mm ²) | 10 (6mm ²) | 2 (35mm ²) | 10 (6mm ²) | .271-.102 | 3/8-16 x 5/8 | 1/2 | 5/8 | 29/64 | 5/8 | 25/32 |
| SPSS-4 | 1 (35mm ²) | 8 (6mm ²) | 2 (35mm ²) | 8 (10mm ²) | .332-.128 | 3/8-16 x 5/8 | 1-1/16 | 5/8 | 29/64 | 11/16 | 7/8 |
| SPSS-5 | 1/0 (50mm ²) | 2 (35mm ²) | 2 (35mm ²) | - | .385-.258 | 1/2-13 x 3/4 | 1-1/4 | 3/4 | 37/64 | 3/4 | 15/16 |
| SPSS-6 | 2/0 (70mm ²) | 2 (35mm ²) | 2 (35mm ²) | - | .443-.258 | 1/2-13 x 3/4 | 1-13/32 | 3/4 | 37/64 | 7/8 | 1-1/16 |
| SPSS-8 | 4/0 (95mm ²) | 1 (35mm ²) | - | - | .570-.289 | 5/8-11 x 1 | 1-9/16 | 1 | 51/64 | 1 | 1-5/16 |
| SPSS-9 | 350 (150mm ²) | 1/0 (70mm ²) | - | - | .715-.373 | 5/8-11 x 1 | 2 | 1-1/4 | 51/64 | 1-5/16 | 1-11/16 |
| SPSS-10 | 500 (240mm ²) | 3/0 (95mm ²) | - | - | .840-.464 | 3/4-10 x 1-1/4 | 2-1/4 | 1-3/4 | 63/64 | 1-1/2 | 1-7/8 |

All wire sizes, unless noted otherwise, are American Wire Gauge (AWG)
UL File E158587

Bronze, Service Post Connectors

Single Conductor Type - Long Stud, Male

RoHS
Compliant

UL
LISTED
8M24

SA
AP-100973-1

TYPE SPS

Features

- Range taking
- Re-usable
- UL 486A/B and UL 467 Listed
- For grounding of steel structures, fence posts and tapping cables from bus bar
- For copper to copper connections

Benefits

- Permits inventories to be kept to a minimum
- Provides efficient use and flexibility in the field
- Ensures reliability
- Flexibility in the field

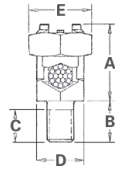

| Catalog Number | Conductor Range AWG MM ² | | | | Max Dia. Range | Stud Size | Dimensions (in.) | | | | |
|----------------|-------------------------------------|--------------------------|------------------------|------------------------|----------------|----------------|------------------|-------|---------|-------|--------|
| | Stranded | | Solid | | | | A | B | C | D | E |
| | Max. | Min. | Max. | Min. | | | | | | | |
| SPSL-0 | 8 | 12 (4mm ²) | 8 (10mm ²) | 12 (4mm ²) | .146-.080 | 1/4-20 x 1 | 11/16 | 1 | 55/64 | 15/32 | 1/2 |
| SPSL-1 | 7 (10mm ²) | 10 (6mm ²) | 6 (10mm ²) | 10 (6mm ²) | .170-.102 | 1/4-20 x 1 | 13/16 | 1 | 55/64 | 15/32 | 21/32 |
| SPSL-2 | 5 (16mm ²) | 10 (6mm ²) | 4 (16mm ²) | 10 (6mm ²) | .217-.102 | 5/16-18 x 1 | 15/16 | 1 | 53/64 | 17/32 | 23/32 |
| SPSL-3 | 3 (25mm ²) | 10 (6mm ²) | 2 (35mm ²) | 10 (6mm ²) | .271-.102 | 3/8-16 x 1-1/8 | 1/2 | 1-1/8 | 61/64 | 5/8 | 25/32 |
| SPSL-4 | 1 (35mm ²) | 8 (6mm ²) | 2 (35mm ²) | 8 (10mm ²) | .332-.128 | 3/8-16 x 1-1/8 | 1-1/16 | 1-1/8 | 61/64 | 11/16 | 7/8 |
| SPSL-5 | 1/0 (50mm ²) | 2 (35mm ²) | 2 (35mm ²) | - | .385-.258 | 1/2-13 x 1-1/4 | 1-1/4 | 1-1/4 | 1-5/64 | 3/4 | 15/16 |
| SPSL-6 | 2/0 (70mm ²) | 2 (35mm ²) | 2 (35mm ²) | - | .443-.258 | 1/2-13 x 1-1/4 | 1-13/32 | 1-1/4 | 1-5/64 | 7/8 | 1-1/16 |
| SPSL-8 | 4/0 (95mm ²) | 1 (35mm ²) | - | - | .570-.289 | 5/8-11 x 1-1/2 | 1-9/16 | 1-1/2 | 1-19/64 | 1 | 1-5/16 |
| SPSL-10 | 500 (240mm ²) | 3/0 (95mm ²) | - | - | .840-.464 | 3/4-10 x 1-3/4 | 2-1/4 | 1-1/2 | 1-31/64 | 1-1/2 | 1-7/8 |

All wire sizes, unless noted otherwise, are American Wire Gauge (AWG)
UL File E158587

G

Bronze, Service Post Connectors

Double Conductor Type - Short Stud, Male

RoHS
Compliant

UL
LISTED
8M24

SA
AP-100973-1

TYPE
SPD

Features

- Range taking
- Re-usable
- UL 486A/B and UL 467 Listed
- For grounding of steel structures, fence posts and tapping cables from bus bar
- For copper to copper connections

Benefits

- Permits inventories to be kept to a minimum
- Provides efficient use and flexibility in the field
- Ensures reliability
- Flexibility in the field

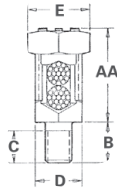

G

| Catalog Number | Conductor Range AWG MM ² | | | | Max Dia. Range | Stud Size | Dimensions (in.) | | | | |
|----------------|-------------------------------------|--------------------------|------------------------|------------------------|----------------|----------------|------------------|-------|-------|-------|--------|
| | Stranded | | Solid | | | | AA | B | C | D | E |
| | Max. | Min. | Max. | Min. | | | | | | | |
| SPDS-0 | 8 | 12 (4mm ²) | 8 (10mm ²) | 12 (4mm ²) | .146-.080 | 1/4-20 x 1/2 | 13/16 | 1/2 | 23/64 | 15/32 | 1/2 |
| SPDS-1 | 7 (10mm ²) | 10 (6mm ²) | 6 (10mm ²) | 10 (6mm ²) | .170-.102 | 1/4-20 x 1/2 | 31/32 | 1/2 | 23/64 | 15/32 | 21/32 |
| SPDS-2 | 5 (16mm ²) | 10 (6mm ²) | 4 (16mm ²) | 10 (6mm ²) | .217-.102 | 5/16-18 x 5/8 | 1-1/8 | 5/8 | 25/64 | 17/32 | 23/32 |
| SPDS-3 | 3 (25mm ²) | 10 (6mm ²) | 2 (35mm ²) | 10 (6mm ²) | .271-.102 | 3/8-16 x 5/8 | 1-1/4 | 5/8 | 29/64 | 5/8 | 25/32 |
| SPDS-4 | 1 (35mm ²) | 8 (6mm ²) | 2 (35mm ²) | 8 (10mm ²) | .332-.128 | 3/8-16 x 5/8 | 1-3/8 | 5/8 | 29/64 | 11/16 | 7/8 |
| SPDS-5 | 1/0 (50mm ²) | 2 (35mm ²) | 2 (35mm ²) | - | .385-.258 | 1/2-13 x 3/4 | 1-19/32 | 3/4 | 37/64 | 3/4 | 15/16 |
| SPDS-6 | 2/0 (70mm ²) | 2 (35mm ²) | 2 (35mm ²) | - | .443-.258 | 1/2-13 x 3/4 | 1-13/16 | 3/4 | 37/64 | 7/8 | 1-1/16 |
| SPDS-8 | 4/0 (95mm ²) | 1 (35mm ²) | - | - | .570-.289 | 5/8-11 x 1 | 2-1/16 | 1 | 51/64 | 1 | 1-5/16 |
| SPDS-10 | 500 (240mm ²) | 3/0 (95mm ²) | - | - | .840-.464 | 3/4-10 x 1-1/4 | 3-1/8 | 1-3/4 | 63/64 | 1-1/2 | 1-7/8 |

All wire sizes, unless noted otherwise, are American Wire Gauge (AWG)
UL File E158587

Bronze, Service Post Connectors

Double Conductor Type - Long Stud, Male

RoHS
Compliant



TYPE SPD

Features

- Range taking
- Re-usable
- UL 486A/B and UL 467 Listed
- For grounding of steel structures, fence posts and
- tapping cables from bus bar
- For copper to copper connections

Benefits

- Permits inventories to be kept to a minimum
- Provides efficient use and flexibility in the field
- Ensures reliability
- Flexibility in the field

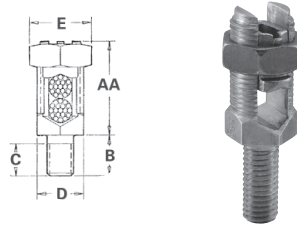

| Catalog Number | Conductor Range AWG MM ² | | | | Max Dia. Range | Stud Size | Dimensions (in.) | | | | |
|----------------|-------------------------------------|--------------------------|------------------------|------------------------|----------------|----------------|------------------|-------|---------|--------|---------|
| | Stranded | | Solid | | | | AA | B | C | D | E |
| | Max. | Min. | Max. | Min. | | | | | | | |
| SPDL-0 | 8 | 12 (4mm ²) | 8 (10mm ²) | 12 (4mm ²) | .146-.080 | 1/4-20 x 1 | 13/16 | 1 | 55/64 | 15/32 | 1/2 |
| SPDL-1 | 7 (10mm ²) | 10 (6mm ²) | 6 (10mm ²) | 10 (6mm ²) | .170-.102 | 1/4-20 x 1 | 31/32 | 1 | 55/64 | 15/32 | 21/32 |
| SPDL-2 | 5 (16mm ²) | 10 (6mm ²) | 4 (16mm ²) | 10 (6mm ²) | .217-.102 | 5/16-18 x 1 | 1-1/8 | 1 | 53/64 | 17/32 | 23/32 |
| SPDL-3 | 3 (25mm ²) | 10 (6mm ²) | 2 (35mm ²) | 10 (6mm ²) | .271-.102 | 3/8-16 x 1-1/8 | 1-1/4 | 1-1/8 | 61/64 | 5/8 | 25/32 |
| SPDL-4 | 1 (35mm ²) | 8 (6mm ²) | 2 (35mm ²) | 8 (10mm ²) | .332-.128 | 3/8-16 x 1-1/8 | 1-3/8 | 1-1/8 | 61/64 | 11/16 | 7/8 |
| SPDL-5 | 1/0 (50mm ²) | 2 (35mm ²) | 2 (35mm ²) | - | .385-.258 | 1/2-13 x 1-1/4 | 1-19/32 | 1-1/4 | 1-5/64 | 3/4 | 15/16 |
| SPDL-6 | 2/0 (70mm ²) | 2 (35mm ²) | 2 (35mm ²) | - | .443-.258 | 1/2-13 x 1-1/4 | 1-13/16 | 1-1/4 | 1-5/64 | 7/8 | 1-1/16 |
| SPDL-8 | 4/0 (95mm ²) | 1 (35mm ²) | - | - | .570-.289 | 5/8-11 x 1-1/2 | 2-1/16 | 1-1/2 | 1-19/64 | 1 | 1-5/16 |
| SPDL-9 | 350 (150mm ²) | 1/0 (70mm ²) | - | - | .715-.373 | 5/8-11 x 1-1/2 | 2-3/4 | 1-1/2 | 1-19/64 | 1-5/16 | 1-11/16 |
| SPDL-10 | 500 (240mm ²) | 3/0 (95mm ²) | - | - | .840-.464 | 3/4-10 x 1-3/4 | 3-1/8 | 1-1/2 | 1-31/64 | 1-1/2 | 1-7/8 |

All wire sizes, unless noted otherwise, are American Wire Gauge (AWG)
UL File E158587



Bronze, Transformer Tank Ground Connectors

RoHS
Compliant

TYPE TTGC

Features

- Manufactured from bronze
- Eye bolt on TTGC2 rotates to accommodate cable in vertical or horizontal direction
- Range taking
- Stud fits all standard EEI-NEMA distribution transformers

Benefits

- Provides maximum strength and superior conductivity
- Flexibility
- Permits inventories to be kept to a minimum
- Reliability

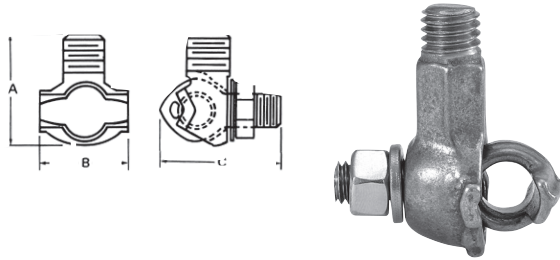

| Catalog Number | Conductor Range | | Stud Thread Size UNC - 2A | Dimensions (in.) | | |
|----------------|-----------------|--------|---------------------------|------------------|--------|---------|
| | Max. | Min. | | A | B | C |
| TTGC2 | 2/0 | 8 sol | 1/2-13 | 1-51/64 | 1-9/64 | 1-21/32 |
| TTGC3 | 1 str | 10 sol | 1/2-13 | 1-3/8 | 1-3/64 | 1-9/16 |
| TTGC4+ | 1 str | 10 sol | 1/2-13 | 1-1/4 | 7/8 | 1-3/8 |
| TTGC2TN+ | 2/0 | 8 sol | 1/2-13 | 1-51/64 | 1-9/64 | 1-21/32 |
| TTGC3TN* | 1 str | 10 sol | 1/2-13 | 1-3/8 | 1-3/64 | 1-9/16 |
| TTGC4TN* | 1 str | 10 sol | 1/2-13 | 1-1/4 | 7/8 | 1-3/8 |

All wire sizes, unless noted otherwise, are American Wire Gauge (AWG)

+ RUS Listed

* Tin Plated

G

U-Bolt Ground Clamp

for Pipes, Rods, Rebar, and Fence Posts

Tube O.D. Range: 0.500 - 2.375 in.

RoHS
Compliant

UL
LISTED
667P

SA
LR-29601

TYPE GPL

Features

- For parallel and 90° copper conductor connections to pipes, rods, rebar and fence posts
- Components made from bronze and copper alloys
- Silicone bronze hardware
- Specially designed spacer
- Range taking
- Re-usable
- UL 467 Listed for direct burial and CSA Certified

Benefits

- Efficient use and flexibility in the field
- Provides maximum conductivity
- Corrosion resistant for longevity
- Enables cable alignment and positive contact
- Minimizes inventories
- Optimizes cost and flexibility for rework applications
- Ensures a safe and reliable grounding connection

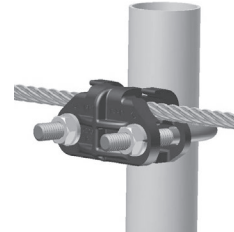
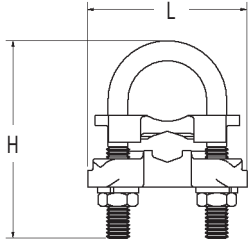
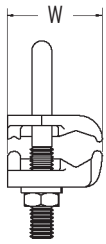

Wire perpendicular to post



Wire parallel to post

| Catalog Number | Wire Range | Tube I.P.S. | Rebar | Ground Rod | O.D. Range - in. (mm) | | Overall Dimensions - in. (mm) | | |
|----------------|-------------------|-------------|-------|-------------|-----------------------|--------------|-------------------------------|--------------|--------------|
| | | | | | Min. | Max. | W | H | L |
| GPL-17 | 500kcmil-300kcmil | 1 | - | 1 1/8-1 1/4 | 1.125 (28.6) | 1.310 (33.3) | 1.563 (39.7) | 3.540 (89.9) | 2.750 (69.9) |
| GPL-23 | 500kcmil-300kcmil | 1 1/4 | - | 1 3/8-1 1/2 | 1.375 (34.9) | 1.660 (42.2) | 1.563 (39.7) | 3.665 (93.1) | 3.000 (76.2) |

G

All wire sizes, unless noted otherwise, are American Wire Gauge (AWG)
Tested to UL 467, UL File E34440

U-Bolt Ground Clamp

for Pipes, Rods, Rebar, and Fence Posts

Tube O.D. Range: 2.500 - 6.500 in.

RoHS
Compliant

UL
LISTED
667P

CSA
LR-29601

TYPE
GPL

Features

- For parallel and 90° copper conductor connections to pipes, rods, rebar and fence posts
- Components made from bronze and copper alloys
- Silicone bronze hardware
- Specially designed spacer
- Range taking
- Re-usable
- UL 467 Listed for direct burial and CSA Certified

Benefits

- Efficient use and flexibility in the field
- Provides maximum conductivity
- Corrosion resistant for longevity
- Enables cable alignment and positive contact
- Minimizes inventories
- Optimizes cost and flexibility for rework applications
- Ensures a safe and reliable grounding connection

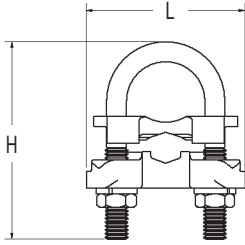
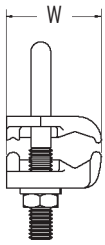

Wire perpendicular to post



Wire parallel to post

| Catalog Number | Wire Range | Tube I.P.S. | Rebar | Ground Rod | O.D. Range - in. (mm) | | Overall Dimensions - in. (mm) | | |
|----------------|-------------------|-------------|-------|------------|-----------------------|---------------|-------------------------------|---------------|---------------|
| | | | | | Min. | Max. | W | H | L |
| GPL-71 | 500kcmil-300kcmil | 5 | - | 5-5 1/2 | 5.000 (127.0) | 5.500 (139.7) | 1.563 (39.7) | 8.665 (220.1) | 7.000 (177.8) |

G

All wire sizes, unless noted otherwise, are American Wire Gauge (AWG)
Tested to UL 467, UL File E34440

Copper Ground Straps

RoHS
Compliant

TYPE GS

Features

- Manufactured from annealed copper sheet
- Two styles available
- Type GSR supplied in 10' coils with 1/4 in holes

Benefits

- Provides maximum conductivity and greater flexibility
- Heavy-Duty or lightweight in four different lengths
- Can be cut to desired length which reduces inventory



Fig. 1

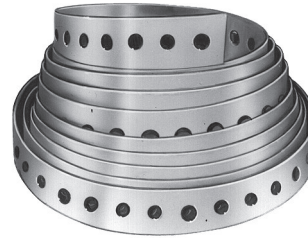

Fig. 2

| Catalog Number | Figure Number | Pipe Size | Dimensions (in.) | | Type |
|----------------|---------------|-----------|------------------|-----|------------------|
| | | | L | W | |
| GS-4 | 1 | 3/8-4 | 15-3/4 | 3/4 | Heavy .050 thick |
| GS-10 | 1 | 3/8-1 | 5-17/32 | 3/4 | Light .025 thick |
| GS-40 | 1 | 3/8-4 | 15-3/4 | 3/4 | Light .025 thick |

G

Copper Neutral Bars

RoHS
Compliant



TYPE D167

Features

- Manufactured from high strength copper tubing
- Range taking
- UL Recognized for 600 volts

Benefits

- Provides maximum conductivity
- A wide range of conductor sizes can be used in the same connector
- Ensures reliability for copper conductor

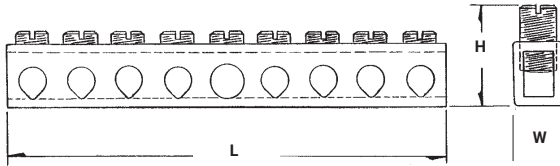

| Catalog Number | Number of Taps | Wire Range | | Dimensions (in.) | | | | | Mounting Hole Positions | |
|----------------|----------------|------------|------|------------------|--------------------------|-------|-----------|--------------------|----------------------------------------|------------------------|
| | | Main | Tap | L | Height With Maximum Wire | W | Bolt Size | Two Mounting Holes | From End Of Bar To First Mounting Hole | Distance Between Holes |
| D167-4 | 4 | 4-14 | 6-14 | 2-3/4 | 3/4 | 11/32 | #10 | 13/64 | .581 (2nd hole) | 1.98 |
| D167-6 | 6 | 4-14 | 6-14 | 3-1/2 | 3/4 | 11/32 | #10 | 13/64 | .978 (3rd hole) | 1.98 |
| D167-8 | 8 | 4-14 | 6-14 | 4-7/16 | 3/4 | 11/32 | #10 | 13/64 | 1.375 (4th hole) | 1.98 |
| D167-10 | 10 | 4-14 | 6-14 | 5-1/8 | 3/4 | 11/32 | #10 | 13/64 | 1.772 (5th hole) | 1.98 |
| D167-12 | 12 | 4-14 | 6-14 | 5-15/16 | 3/4 | 11/32 | #10 | 13/64 | 2.169 (6th hole) | 1.98 |
| D167-14 | 14 | 4-14 | 6-14 | 6-23/32 | 3/4 | 11/32 | #10 | 13/64 | 2.566 (7th hole) | 1.98 |

All wire sizes, unless noted otherwise, are American Wire Gauge (AWG)
Tested to UL 486A/B and UL 467, UL File E6207

G

Copper Neutral Bars

TYPE CAN

Features

- Manufactured from high strength copper tubing
- Compact design
- Range taking
- Circuit bars inserted at a 20 angle
- Copper conductor only

Benefits

- Provides maximum conductivity
- Up to 42 circuit taps can be made in just 5 1/2 in of space
- A wide range of conductor sizes can be used in the same connector
- Provides easy wire insertion

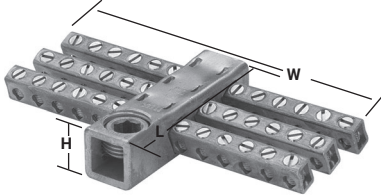

Fig. 1



Fig. 2

Fig. 3

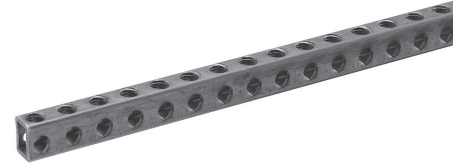

Fig. 4

| Catalog Number | Figure Number | Number of Taps | Wire Range | | Dimensions (in.) | | | |
|----------------|---------------|-------------------------------------------------------------------------------------------------------------------------------------------|------------|------|------------------|--------------------------|---------|---------------------------|
| | | | Main | Tap | L | Height With Maximum Wire | W | Two Tapped Mounting Holes |
| CAN-300 | 1 | 24 | 250kcmil-6 | 6-14 | 2-5/16 | 1-5/16 | 5-1/8 | 10-32 |
| CAN-301 | 1 | 30 | 250kcmil-6 | 6-14 | 3 | 1-5/16 | 4-13/32 | 10-32 |
| CAN-302 | 1 | 36 | 250kcmil-6 | 6-14 | 3 | 1-5/16 | 5-1/8 | 10-32 |
| CAN-303 | 1 | 42 | 250kcmil-6 | 6-14 | 3 | 1-7/16 | 5-1/2 | 10-32 |
| R-16 | 2 | Mounting block of general purpose (phenolic black) suitable for mounting any of CAN Neutrals. 2-1/2 in wide x 2-1/2 in long x 1 in thick. | | | | | | |
| E-223 | 3 | 10-32 x 1/2 in round head steel machine screws for fastening neutrals to mounting blocks. (Use lock washer to provide rigid assembly.) | | | | | | |
| E-153 | 3 | 1/4-28 wire pressure screw 7/16 in long. Screw is steel, zinc plated and chromate dipped. | | | | | | |
| N-174‡ | 4 | Supplied in 5' 9 in lengths. Approximately 174 outlets. Wire range 14-6. | | | | | | |

All wire sizes, unless noted otherwise, are American Wire Gauge (AWG)

Tested to UL 486A/B, UL File E6207

‡ Tested to UL 486A/B and UL 467, UL File E6207



Dual Rated Lay-In Ground Lug



TYPE SGB

Features

- Manufactured from high strength 6061-T6 aluminum alloy
- Electro-tin plated
- Lay-in feature
- Exclusive Viridium plating
- Green color universal to identify ground
- Serrations in conductor wire way
- Unique clamp design
- 1/4 in max frame thickness (SGB-4, SGB-5)
- Meets ASTM B117-09

Benefits

- Suitable for use with copper or aluminum conductors
- Provides low contact resistance
- Provides ease of installation
- Resists galvanic corrosion
- Aids visual inspection
- Cuts oxidation
- No mounting hardware required, reusable
- Mount to solar panel frames
- Resistance to outdoor salt spray

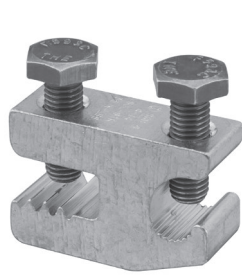
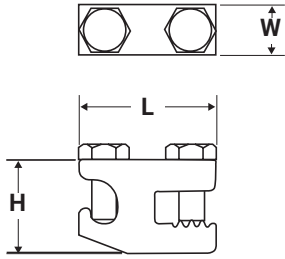

Fig. 1

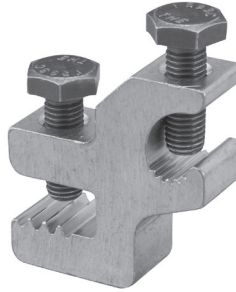

Fig. 2

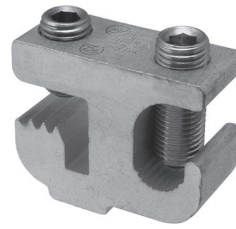

Fig. 3

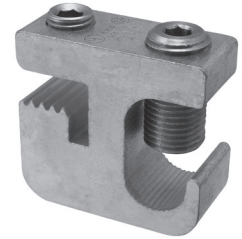

Fig. 4

| Catalog Number | Figure Number | Ground Wire Range | Dimensions - in. (mm) | | | Hex Size |
|----------------|---------------|------------------------|-----------------------|--------------|--------------|----------|
| | | | L | W | H | |
| SGB-4+ | 1 | 4 sol/str-14 sol/str | 1.375 (34.9) | 0.500 (12.7) | 0.941 (23.9) | 7/16 |
| SGB-5+ | 2 | 4 sol/str-14 sol/str | 1.375 (34.9) | 0.500 (12.7) | 1.440 (36.6) | 7/16 |
| SGB-1/0 | 3 | 1/0 sol/str-14 sol/str | 1.508 (38.3) | 0.625 (15.9) | 1.241 (31.5) | 3/16 |
| SGB-250 | 4 | 250kcmil-6 | 1.810 (46.0) | 0.750 (19.1) | 1.703 (43.3) | 3/16 |

All wire sizes, unless noted otherwise, are American Wire Gauge (AWG)
 UL 467 for grounding and bonding. UL File E34440
 + UL2703 Recognized E354420 Vol. 1
 De-Ox oxide inhibitor is recommended for all aluminum terminations
 Patented

G

Dual Rated Lay-In Ground Lug

TYPE GBL

Features

- Manufactured from high strength 6061-T6 aluminum alloy
- Electro-tin plated
- Lay-in feature

Benefits

- Suitable for use with copper or aluminum conductors
- Provides low contact resistance
- Provides ease of installation

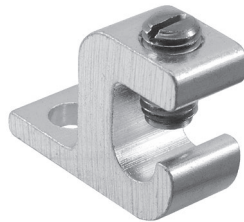
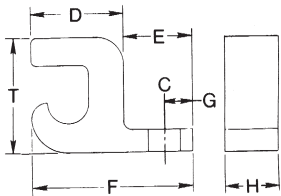

Fig. 1

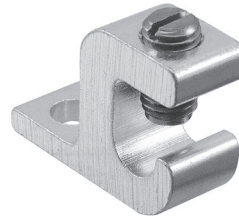

Fig. 2

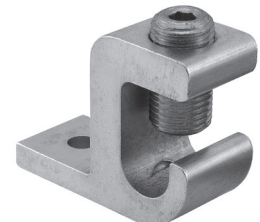

Fig. 3

| Catalog Number | Figure Number | Ground Wire Range | Bolt Size | Dimensions (in.) | | | | | | | Hex Size |
|----------------|---------------|-------------------|-----------|------------------|-------|-------|--------|-------|-------|---------|----------|
| | | | | C | D | E | F | G | H | T | |
| * GBL-4 | 1 | 4-14 | 10 | 7/32 | 5/8 | 31/64 | 1-3/32 | 13/64 | 25/64 | 51/64 | Slot |
| + ‡ GBL-4SS | 2 | 4-14 | 10 | 7/32 | 5/8 | 31/64 | 1-3/32 | 13/64 | 25/64 | 51/64 | Slot |
| GBL-1/0 | 2 | 1/0-14 | 1/4 | 9/32 | 51/64 | 27/32 | 1-5/8 | 7/16 | 5/8 | 1-5/32 | Slot |
| GBL-250 | 3 | 250kcmil-6 | 1/4 | 9/32 | 31/64 | 1 | 2-3/16 | 29/64 | 7/8 | 1-23/32 | 7/32 |

All wire sizes, unless noted otherwise, are American Wire Gauge (AWG)

UL File E34440

* UL 467 and UL 486A/B Listed

+ UL 467 Listed

‡ GBL-4SS is UL2703 Listed UL E354420 Vol. 2

+ Supplied with stainless steel hardware. Meets ASTM B117-09 and is resistant to outdoor salt spray

De-Ox oxide inhibitor is recommended for all aluminum terminations

Optional MH Series mounting hardware kits available, consult nVent ILSCO

G

Aluminum Grounding Connectors

Dual Rated

RoHS
Compliant

TYPE
GRM
GRF

Features

- Manufactured from high strength 6061-T6 aluminum alloy
- Electro-tin plated
- Type GRM - Elongated steel stud
- Type GRF - Threaded female design

Benefits

- Suitable for use with either copper or aluminum conductors
- Provides low contact resistance
- Provides ease of grounding a single conductor to steel structures or to tap a single conductor from bus bar
- Provides ease of installation for a variety of standard stud sizes

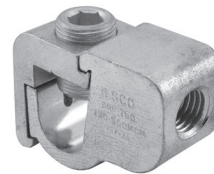
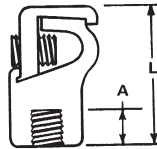
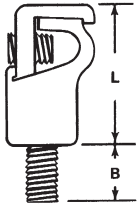

Fig. 1

Fig. 2

| Catalog Number | Figure Number | Wire Range Single Cable | | | Dia. Thread | Dimensions (in.) | | | Hex Size |
|----------------|---------------|-------------------------|-----------|--------------|-------------|------------------|-----|---------|----------|
| | | Max. | Min. | Steel Strand | | A | B | L | |
| GRM-2B | 1 | 2str | 12sol/str | 5/16 | 5/16 in-18 | - | 3/8 | 1-1/4 | Slot |
| GRF-2A | 2 | 2str | 12sol/str | 5/16 | 1/4 in-20 | 5/16 | - | 1-1/4 | Slot |
| GRF-2B | 2 | 2str | 12sol/str | 5/16 | 5/16 in-18 | 3/8 | - | 1-1/4 | Slot |
| GRF-0 | 2 | 1/0str | 2str | 3/8 | 1/2 in-13 | 1/2 | - | 1-9/16 | Slot |
| GRF-250B | 2 | 250kcmil | 1/0 | 9/16 | 5/8 in-11 | 3/4 | - | 2-1/8 | 5/16 |
| GRF-350 | 2 | 350kcmil | 4/0 | - | 5/8 in-11 | 3/4 | - | 2-1/2 | 3/8 |
| GRF-500 | 2 | 500kcmil | 350kcmil | - | 3/4 in-10 | 7/8 | - | 2-15/16 | 3/8 |

G

All wire sizes, unless noted otherwise, are American Wire Gauge (AWG)
De-Ox Inhibitor is recommended for all aluminum terminations.

nVent ILSCO PermaGround

Ground Clamp Connectors

Double Wire, One Bolt



TYPE
GH
GHS

Features

- Manufactured from copper alloy
- Furnished with silicon bronze bolt, nut, and lock washer
- Mountable for surfaces up to 1/4 in thick
- UL 467 Listed for grounding and bonding up to 250kcmil

Benefits

- Provides maximum conductivity
- For clamping conductors to flat surfaces
- Fits standard grounding bus bar and various flat plate metal surfaces
- Suitable for direct burial in earth or concrete

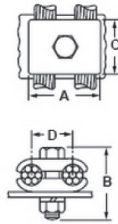

Fig. 1

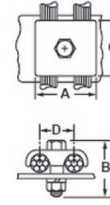

Fig. 2

| Catalog Number | Figure Number | Wire Range | Dimensions - in. (mm) | | | | Bolt Size |
|----------------|---------------|--------------------|-----------------------|--------------|--------------|--------------|-----------|
| | | | A | B | C | D | |
| GH-6 | 1 | 1000kcmil-750kcmil | 3.625 (92.1) | 3.750 (95.3) | 2.500 (63.5) | 2.000 (50.8) | 5/8 |
| GHS-1* | 2 | 4str-8sol | 1.250 (31.8) | 1.375 (34.9) | 1.375 (34.9) | 0.750 (19.1) | 3/8 |
| GHS-5 | 2 | 750kcmil-500kcmil | 3.250 (82.6) | 2.750 (69.9) | 2.375 (60.3) | 1.750 (44.5) | 5/8 |



All wire sizes, unless noted otherwise, are American Wire Gauge (AWG)
*UL File E158587

PermaGround

Ground Clamp Connectors

Single Wire



TYPE
GMS
GWL

Features

- Manufactured from copper alloy
- Furnished with silicon bronze bolt, nut, and lock washer
- Mountable for surfaces up to 1/4 in thick
- UL 467 Listed for grounding and bonding up to 250kcmil as well as UL 486 A/B

Benefits

- Provides maximum conductivity
- For clamping conductors to flat surfaces
- Fits standard grounding bus bar and various flat plate metal surfaces
- Suitable for direct burial in earth or concrete

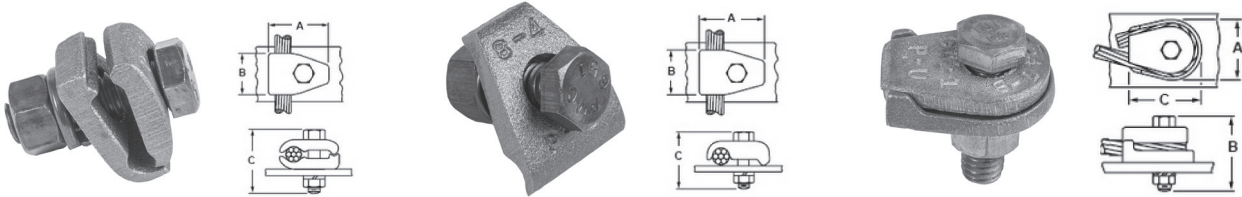

Fig. 1

Fig. 2

Fig. 3

| Catalog Number | Figure Number | Wire Range | Dimensions - in. (mm) | | | Bolt Size |
|----------------|---------------|--------------------|-----------------------|--------------|--------------|-----------|
| | | | A | B | C | |
| GMS-6* | 2 | 1000kcmil-750kcmil | 3.500 (88.9) | 1.875 (47.6) | 3.125 (79.4) | 5/8 |
| GWL-1 | 3 | 4str-8sol | 1.125 (28.6) | 1.500 (38.1) | 1.375 (34.9) | 3/8 |
| GWL-2 | 3 | 4str-8sol | 1.750 (44.5) | 1.750 (44.5) | 1.875 (47.6) | 1/2 |
| GWL-6 | 3 | 250kcmil-3/0str | 2.250 (57.2) | 2.375 (60.3) | 2.375 (60.3) | 1/2 |
| GWL-7 | 3 | 250kcmil-3/0str | 2.250 (57.2) | 2.500 (63.5) | 2.375 (60.3) | 5/8 |

G

All wire sizes, unless noted otherwise, are American Wire Gauge (AWG)
*UL File E158587

PermaGround

Ground Clamp Connectors

Braid, Cable or Strip to Pipe



TYPE
GO

Features

- Manufactured from copper alloy
- Furnished with silicon bronze U-bolt, nut, and lock washer
- UL 467 Listed for grounding and bonding

Benefits

- Provides maximum conductivity
- For clamping braid, cable or strip to a pipe
- Suitable for direct burial in earth or concrete

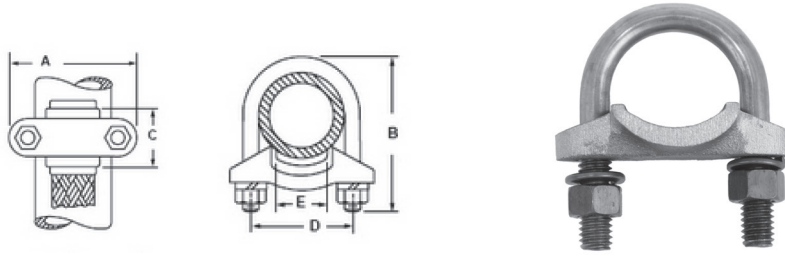

| Catalog Number | Iron Pipe Size | Dimensions - in. (mm) | | | | | Hex Size |
|----------------|----------------|-----------------------|---------------|--------------|---------------|---------------------------|----------|
| | | A | B | C | D | E (Max Braid/Strip Width) | |
| GO-1 | 1 | 2.750 (69.9) | 3.250 (82.6) | 1.250 (31.8) | 1.750 (44.5) | 1.000 (25.4) | 3/8 |
| GO-3 | 1 1/2 | 3.375 (85.7) | 3.500 (88.9) | 1.500 (38.1) | 2.375 (60.3) | 1.000 (25.4) | 3/8 |
| GO-6 | 2 | 3.750 (95.3) | 4.250 (108.0) | 1.500 (38.1) | 2.813 (71.4) | 1.500 (38.1) | 3/8 |
| GO-7 | 2 | 4.000 (101.6) | 4.375 (111.1) | 1.750 (44.5) | 2.938 (74.6) | 2.000 (50.8) | 1/2 |
| GO-8 | 2 1/2 | 4.500 (114.3) | 5.000 (127.0) | 1.875 (47.6) | 3.438 (87.3) | 2.000 (50.8) | 1/2 |
| GO-10 | 3 | 5.250 (133.4) | 6.250 (158.8) | 2.000 (50.8) | 4.063 (103.2) | 2.000 (50.8) | 1/2 |
| GO-11 | 3 | 5.250 (133.4) | 6.250 (158.8) | 2.000 (50.8) | 4.063 (103.2) | 2.500 (63.5) | 1/2 |
| GO-12 | 3 | 5.250 (133.4) | 6.250 (158.8) | 2.000 (50.8) | 4.063 (103.2) | 3.000 (76.2) | 1/2 |
| GO-13 | 3 1/2 | 5.750 (146.1) | 5.875 (149.2) | 2.250 (57.2) | 4.563 (115.9) | 2.000 (50.8) | 1/2 |
| GO-15 | 3 1/2 | 5.750 (146.1) | 5.875 (149.2) | 2.250 (57.2) | 4.563 (115.9) | 3.000 (76.2) | 1/2 |
| GO-16 | 4 | 6.250 (158.8) | 6.500 (165.1) | 2.250 (57.2) | 5.063 (128.6) | 2.000 (50.8) | 1/2 |
| GO-19 | 4 | 6.250 (158.8) | 6.500 (165.1) | 2.750 (69.9) | 5.063 (128.6) | 3.500 (88.9) | 1/2 |



All wire sizes, unless noted otherwise, are American Wire Gauge (AWG)
UL File E158587

PermaGround

Ground Clamp Connectors

Three Equal Size Cables to Pipe or Rod



TYPE
GR

Features

- Manufactured from copper alloy
- Furnished with silicon bronze U-bolt, nut, and lock washer
- Multi-functional body design
- UL 467 Listed for grounding and bonding up to 250kcmil

Benefits

- Provides maximum conductivity
- For clamping parallel cable or wires to pipe or rod in perpendicular orientation
- For clamping three equal size cables to a metal pipe, rod, or post
- Suitable for direct burial in earth or concrete

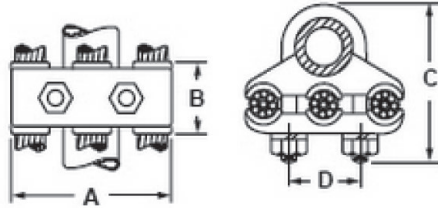

G

| Catalog Number | Accommodates | | Wire Range | Dimensions - in. (mm) | | | | Hex Size |
|----------------|--------------|----------------|-------------------|-----------------------|--------------|---------------|---------------|----------|
| | Rod/Post | Iron Pipe Size | | A | B | C | D | |
| GR-7* | 5/8 or 3/4 | 3/8 | 500kcmil-300kcmil | 4.000 (101.6) | 1.625 (41.3) | 3.250 (82.6) | 1.125 (28.6) | 1/2 |
| GR-9 | 7/8 or 1 | 1/2 or 3/4 | 2/0str-4sol | 3.500 (88.9) | 1.500 (38.1) | 3.250 (82.6) | 1.500 (38.1) | 3/8 |
| GR-11* | 7/8 or 1 | 1/2 or 3/4 | 500kcmil-300kcmil | 4.375 (111.1) | 1.625 (41.3) | 3.500 (88.9) | 1.500 (38.1) | 1/2 |
| GR-14 | - | 1 | 2/0str-4sol | 3.625 (92.1) | 1.500 (38.1) | 3.250 (82.6) | 1.750 (44.5) | 3/8 |
| GR-15 | - | 1 | 250kcmil-2/0sol | 4.125 (104.8) | 1.625 (41.3) | 3.500 (88.9) | 1.750 (44.5) | 3/8 |
| GR-16* | - | 1 | 500kcmil-300kcmil | 4.500 (114.3) | 1.625 (41.3) | 3.750 (95.3) | 1.750 (44.5) | 1/2 |
| GR-20 | - | 1 1/4 | 2/0str-4sol | 4.000 (101.6) | 1.500 (38.1) | 3.750 (95.3) | 2.063 (52.4) | 3/8 |
| GR-21 | - | 1 1/4 | 250kcmil-2/0sol | 4.500 (114.3) | 1.625 (41.3) | 3.875 (98.4) | 2.063 (52.4) | 3/8 |
| GR-26 | - | 1 1/2 | 2/0str-4sol | 4.250 (108.0) | 1.500 (38.1) | 4.000 (101.6) | 2.375 (60.3) | 3/8 |
| GR-27 | - | 1 1/2 | 250kcmil-2/0sol | 4.750 (120.7) | 1.750 (44.5) | 4.250 (108.0) | 2.375 (60.3) | 3/8 |
| GR-31* | - | 2 | 4str-8sol | 4.375 (111.1) | 1.500 (38.1) | 4.250 (108.0) | 2.813 (71.4) | 3/8 |
| GR-33* | - | 2 | 250kcmil-2/0sol | 5.250 (133.4) | 1.750 (44.5) | 5.000 (127.0) | 2.813 (71.4) | 1/2 |
| GR-38* | - | 2 1/2 | 2/0str-4sol | 5.375 (136.5) | 1.500 (38.1) | 5.000 (127.0) | 3.313 (84.1) | 3/8 |
| GR-39* | - | 2 1/2 | 250kcmil-2/0sol | 5.875 (149.2) | 1.750 (44.5) | 5.250 (133.4) | 3.313 (84.1) | 1/2 |
| GR-44* | - | 3 | 2/0str-4sol | 6.000 (152.4) | 1.500 (38.1) | 5.625 (142.9) | 3.938 (100.0) | 3/8 |
| GR-50* | - | 3 1/2 | 2/0str-4sol | 6.375 (161.9) | 1.500 (38.1) | 5.875 (149.2) | 4.438 (112.7) | 1/2 |
| GR-61* | - | 4 | 2/0str-4sol | 6.688 (169.9) | 1.500 (38.1) | 6.375 (161.9) | 4.938 (125.4) | 1/2 |
| GR-62* | - | 4 | 250kcmil-2/0sol | 7.250 (184.2) | 1.750 (44.5) | 6.750 (171.5) | 4.938 (125.4) | 1/2 |

All wire sizes, unless noted otherwise, are American Wire Gauge (AWG)
*UL File E158587

PermaGround

Ground Clamp Connectors

Two Parallel Cables of Wires to Pipe or Rod



TYPE
GT

Features

- Manufactured from copper alloy
- Furnished with silicon bronze nut, and lock washer
- UL 467 Listed for grounding and bonding up to 250kcmil

Benefits

- Provides maximum conductivity
- For clamping parallel cable and wires to pipe or rod in perpendicular orientation
- Suitable for direct burial in earth or concrete

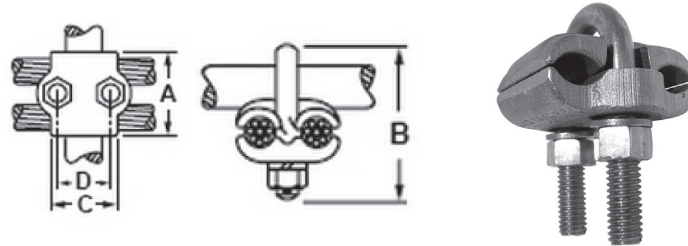

| Catalog Number | Accommodates | | Wire Range | Dimensions - in. (mm) | | | | Hex Size |
|----------------|--------------|----------------|-----------------|-----------------------|---------------|---------------|---------------|----------|
| | Rod/Post | Iron Pipe Size | | A | B | C | D | |
| GT-3* | 1/2 | 1/4 | 250kcmil-2/0sol | 2.500 (63.5) | 2.250 (57.2) | 1.875 (47.6) | 1.000 (25.4) | 3/8 |
| GT-4* | 5/8 or 3/4 | 3/8 | 4str-8sol | 1.625 (41.3) | 2.125 (54.0) | 1.625 (41.3) | 1.125 (28.6) | 3/8 |
| GT-8* | 7/8 or 1 | 1/2 or 3/4 | 4str-8sol | 1.625 (41.3) | 2.500 (63.5) | 1.625 (41.3) | 1.500 (38.1) | 3/8 |
| GT-13* | - | 1 | 4str-8sol | 1.625 (41.3) | 2.750 (69.9) | 1.625 (41.3) | 1.750 (44.5) | 3/8 |
| GT-14* | - | 1 | 2/0str-4sol | 2.000 (50.8) | 3.000 (76.2) | 1.750 (44.5) | 1.750 (44.5) | 3/8 |
| GT-15* | - | 1 | 250kcmil-2/0sol | 2.500 (63.5) | 3.875 (98.4) | 3.125 (79.4) | 1.750 (44.5) | 3/8 |
| GT-18* | - | 1 1/4 | 4str-8sol | 1.625 (41.3) | 3.000 (76.2) | 1.875 (47.6) | 2.063 (52.4) | 3/8 |
| GT-19* | - | 1 1/4 | 2/0str-4sol | 2.000 (50.8) | 3.250 (82.6) | 2.000 (50.8) | 2.063 (52.4) | 3/8 |
| GT-20* | - | 1 1/4 | 250kcmil-2/0sol | 2.500 (63.5) | 3.500 (88.9) | 2.125 (54.0) | 2.063 (52.4) | 3/8 |
| GT-25* | - | 1 1/2 | 2/0str-4sol | 2.000 (50.8) | 3.500 (88.9) | 2.375 (60.3) | 2.375 (60.3) | 3/8 |
| GT-26* | - | 1 1/2 | 250kcmil-2/0sol | 2.500 (63.5) | 3.875 (98.4) | 2.500 (63.5) | 2.375 (60.3) | 3/8 |
| GT-30* | - | 2 | 4str-8sol | 1.750 (44.5) | 3.875 (98.4) | 2.750 (69.9) | 2.813 (71.4) | 3/8 |
| GT-31* | - | 2 | 2/0str-4sol | 2.000 (50.8) | 4.125 (104.8) | 2.875 (73.0) | 2.813 (71.4) | 3/8 |
| GT-32* | - | 2 | 250kcmil-2/0sol | 2.625 (66.7) | 4.250 (108.0) | 3.000 (76.2) | 2.813 (71.4) | 3/8 |
| GT-37* | - | 2 1/2 | 2/0str-4sol | 2.000 (50.8) | 4.500 (114.3) | 3.375 (85.7) | 3.313 (84.1) | 3/8 |
| GT-38* | - | 2 1/2 | 250kcmil-2/0sol | 2.625 (66.7) | 4.750 (120.7) | 3.500 (88.9) | 3.313 (84.1) | 3/8 |
| GT-43* | - | 3 | 2/0str-4sol | 2.000 (50.8) | 5.250 (133.4) | 3.750 (95.3) | 3.938 (100.0) | 3/8 |
| GT-44* | - | 3 | 250kcmil-2/0sol | 2.625 (66.7) | 5.500 (139.7) | 3.750 (95.3) | 3.938 (100.0) | 3/8 |
| GT-49* | - | 3 1/2 | 2/0str-4sol | 2.000 (50.8) | 5.875 (149.2) | 3.875 (98.4) | 4.438 (112.7) | 3/8 |
| GT-50* | - | 3 1/2 | 250kcmil-2/0sol | 2.625 (66.7) | 6.125 (155.6) | 4.000 (101.6) | 4.438 (112.7) | 3/8 |
| GT-55* | - | 4 | 250kcmil-2/0sol | 2.625 (66.7) | 6.500 (165.1) | 4.750 (120.7) | 4.938 (125.4) | 3/8 |

G

All wire sizes, unless noted otherwise, are American Wire Gauge (AWG)

*UL File E158587

PermaGround

Ground Clamp Connectors

Transformer Ground Clamps

TYPE
GSE
HGSE

Features

- Manufactured from copper alloy
- Supplied with steel nuts and lock washers
- Range taking
- HGSE parts provide parallel and perpendicular conductor connection
- HGSE parts provide a hex or square shoulder

Benefits

- Provides maximum conductivity
- For clamping conductors to flat surfaces, acts as a seal to a transformer tank
- Minimizes inventory
- Efficient installation and flexibility in the field
- Accommodates wrench for tightening

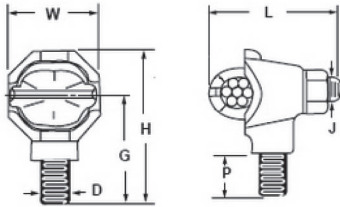

Fig. 1

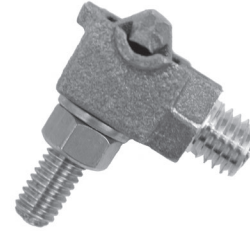

Fig. 2

| Catalog Number | Figure Number | Wire Range | Dimensions - in. (mm) | | | | | Stud Size D | Eye Bolt J |
|----------------|---------------|---------------|-----------------------|---------------|---------------|---------------|---------------|-------------|------------|
| | | | G | H | L | P | W | | |
| GSE-C1 | 1 | 1str-10sol | 0.813 (20.64) | 1.250 (31.75) | 1.500 (38.10) | 0.438 (11.11) | 0.875 (22.23) | 1/2-13 | 3/8-16 |
| HGSE-C1* | 2 | 1str-10sol | 1.188 (30.16) | 1.750 (44.45) | 1.969 (50.01) | 0.438 (11.11) | 1.125 (28.58) | 1/2-13 | 3/8-16 |
| HGSE-020* | 2 | 2/0str-8sol | 1.313 (33.34) | 1.938 (49.21) | 2.000 (50.80) | 0.438 (11.11) | 1.250 (31.75) | 1/2-13 | 3/8-16 |
| HGSE-250* | 2 | 250kcmil-6sol | 1.188 (30.16) | 2.125 (53.98) | 2.625 (66.68) | 0.469 (11.91) | 1.875 (47.63) | 1/2-13 | 1/2-13 |

All wire sizes, unless noted otherwise, are American Wire Gauge (AWG)

*Designates two-way basket

G

PermaGround Ground Clamp Connectors

Two Cables/One Looped Cable to Pipe

Pipe Range: 3/4 in– 2 in



TYPE
GU

Features

- Manufactured from copper alloy
- For parallel copper conductor connections to pipes
- Silicon bronze hardware
- Specially designed spacer
- UL 467 Listed for grounding and bonding up to 250kcmil

Benefits

- Provides maximum conductivity
- Efficient installation and flexibility in the field
- Corrosion resistant for longevity
- Enables conductor alignment and positive contact
- Suitable for direct burial in earth or concrete

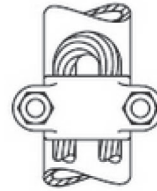
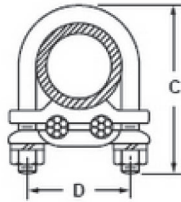
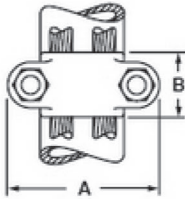

| Catalog Number | Iron Pipe Size | Wire Range | Dimensions - in. (mm) | | | | Bolt Size |
|----------------|----------------|-----------------|-----------------------|--------------|--------------|--------------|-----------|
| | | | A | B | C | D | |
| GU-0* | 3/4 | 4str-8sol | 2.500 (63.5) | 0.875 (22.2) | 2.625 (66.7) | 1.500 (38.1) | 3/8 |
| GU-1* | 1 | 4str-8sol | 2.750 (69.9) | 1.125 (28.6) | 3.000 (76.2) | 1.750 (44.5) | 3/8 |
| GU-3* | 1 | 250kcmil-2/0sol | 2.750 (69.9) | 1.250 (31.8) | 3.500 (88.9) | 1.750 (44.5) | 3/8 |
| GU-4* | 1 1/4 | 4str-8sol | 3.000 (76.2) | 1.125 (28.6) | 3.250 (82.6) | 2.063 (52.4) | 3/8 |
| GU-7* | 1 1/2 | 4str-8sol | 3.375 (85.7) | 1.250 (31.8) | 3.500 (88.9) | 2.375 (60.3) | 3/8 |



All wire sizes, unless noted otherwise, are American Wire Gauge (AWG)
*UL File E158587

PermaGround Ground Clamp Connectors

Two Cables/One Looped Cable to Pipe

Pipe Range: 2-1/2 in– 4 in



TYPE
GU

Features

- Manufactured from copper alloy
- For parallel copper conductor connections to pipes
- Silicon bronze hardware
- Specially designed spacer
- UL 467 Listed for grounding and bonding up to 250kcmil

Benefits

- Provides maximum conductivity
- Efficient installation and flexibility in the field
- Corrosion resistant for longevity
- Enables conductor alignment and positive contact
- Suitable for direct burial in earth or concrete

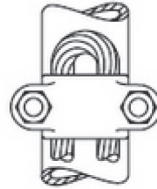
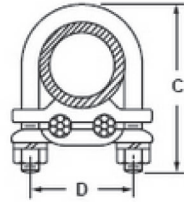
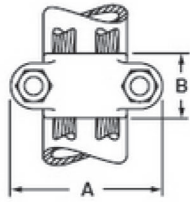

G

| Catalog Number | Iron Pipe Size | Wire Range | Dimensions - in. (mm) | | | | Bolt Size |
|----------------|----------------|-------------------|-----------------------|--------------|---------------|---------------|-----------|
| | | | A | B | C | D | |
| GU-17 | 2 1/2 | 500kcmil-300kcmil | 4.500 (114.3) | 1.500 (38.1) | 5.500 (139.7) | 3.438 (87.3) | 1/2 |
| GU-19* | 3 | 4str-8sol | 5.000 (127.0) | 1.375 (34.9) | 5.250 (133.4) | 3.938 (100.0) | 3/8 |
| GU-22 | 3 | 500kcmil-300kcmil | 5.250 (133.4) | 1.500 (38.1) | 6.000 (152.4) | 4.063 (103.2) | 1/2 |
| GU-25* | 3 1/2 | 4str-8sol | 5.500 (139.7) | 1.500 (38.1) | 6.000 (152.4) | 4.438 (112.7) | 3/8 |
| GU-28 | 3 1/2 | 500kcmil-300kcmil | 5.750 (146.1) | 1.750 (44.5) | 6.375 (161.9) | 4.563 (115.9) | 1/2 |
| GU-34 | 4 | 500kcmil-300kcmil | 6.250 (158.8) | 1.625 (41.3) | 7.250 (184.2) | 5.063 (128.6) | 1/2 |

All wire sizes, unless noted otherwise, are American Wire Gauge (AWG)

*UL File E158587

PermaGround Eye-Bolt Terminal

TYPE
LS
LSN

Features

- Body is manufactured from copper alloy
- Eye-bolts are made from an aluminum bronze alloy
- Available in two mounting surface thickness ranges

Benefits

- Provides maximum conductivity
- Offers maximum strength
- Mountable to flat studs or spades on equipment as well as grounding conductor to steel substation structures

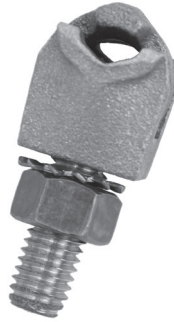
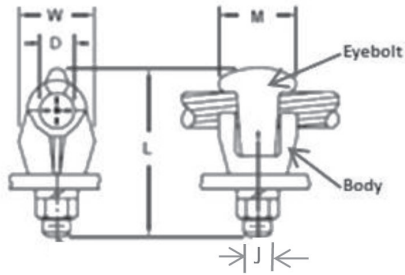

| Catalog Number | Wire Range | Dimensions - in. (mm) | | | | | Hex Size |
|----------------|------------------|-----------------------|---------------|--------------|--------------|-----|----------|
| | | D | L | M | W | J | |
| LSN-2/0N* | 2/0str-8sol | 0.438 (11.1) | 2.375 (60.3) | 1.375 (34.9) | 1.000 (25.4) | 1/2 | 3/4 |
| LSN-025N* | 250kcmil-6sol | 0.625 (15.9) | 2.563 (65.1) | 1.250 (31.8) | 1.063 (27.0) | 1/2 | 3/4 |
| LSN-035N* | 350kcmil-2sol | 0.813 (20.6) | 3.063 (77.8) | 1.250 (31.8) | 1.313 (33.3) | 1/2 | 3/4 |
| LS-C1E+ | 1str-10sol | 0.344 (8.73) | 2.375 (60.3) | 1.063 (27.0) | 0.875 (22.2) | 3/8 | 9/16 |
| LSN-025NE+ | 250kcmil-6sol | 0.625 (15.88) | 3.063 (77.8) | 1.250 (31.8) | 1.063 (27.0) | 1/2 | 3/4 |
| LSN-035NE+ | 350kcmil-2sol | 0.813 (20.64) | 3.313 (84.1) | 1.250 (31.8) | 1.313 (33.3) | 1/2 | 3/4 |
| LSN-100NE+ | 1000kcmil-2/0sol | 1.250 (31.75) | 4.500 (114.3) | 1.719 (43.7) | 1.688 (42.9) | 1/2 | 3/4 |

All wire sizes, unless noted otherwise, are American Wire Gauge (AWG)

"N" in prefix qualifies terminal for mounting on NEMA pads

"N" in suffix qualifies eye-bolt opening to NEMA

*Up to a 1/4 in mounting surface

+1/4 in to 3/4 in mounting surface

G

Aluminum Neutral Bars

Dual Rated

RoHS
Compliant



TYPE NB

Features

- Preassembled, stacked neutral bars
- Available with phenolic base
- Electro-tin plated
- Fabricated from high strength 6061-T6 aluminum alloy

Benefits

- Compact, space saving design offers multiple range taking flexibility and is suitable for grounding applications
- Provides insulation from mounting surface
- Provides low contact resistance
- Suitable for use with either copper or aluminum conductors

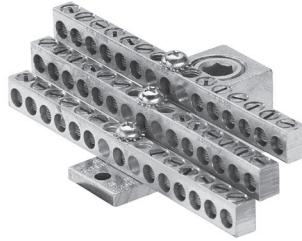
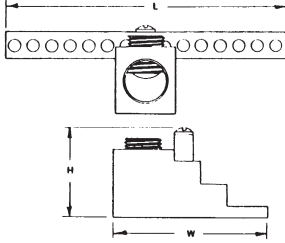

Fig. 1



Fig. 2

G

| Catalog Number | Figure Number | Number of Circuit Taps | Wire Range | | Dimensions (in.) | | | Two Tapped Mounting Holes | Hex Size | |
|------------------|---------------|------------------------|--------------|------------|-------------------------------|---------|---------|---------------------------|----------|------|
| | | | Circuit Taps | Line Loads | Approx. Height with Max. Wire | L | W | | Main | Tap |
| NB-350-12 | 1 | 12 | 14-4 | 350kcmil-6 | 1-17/32 | 4-23/32 | 2-17/32 | 10-32 | 3/8 | Slot |
| NB-350-12-W/R16* | 2 | 12 | 14-4 | 350kcmil-6 | 2-17/32 | 4-23/32 | 2-17/32 | 10-32 | 3/8 | Slot |
| NB-350-24 | 1 | 24 | 14-4 | 350kcmil-6 | 1-17/32 | 4-23/32 | 2-17/32 | 10-32 | 3/8 | Slot |
| NB-350-24-W/R16* | 2 | 24 | 14-4 | 350kcmil-6 | 2-17/32 | 4-23/32 | 2-17/32 | 10-32 | 3/8 | Slot |
| NB-350-30 | 1 | 30 | 14-4 | 350kcmil-6 | 1-17/32 | 4-3/32 | 2-17/32 | 10-32 | 3/8 | Slot |
| NB-350-30-W/R16* | 2 | 30 | 14-4 | 350kcmil-6 | 2-17/32 | 4-3/32 | 2-17/32 | 10-32 | 3/8 | Slot |
| NB-350-36 | 1 | 36 | 14-4 | 350kcmil-6 | 1-17/32 | 4-23/32 | 2-17/32 | 10-32 | 3/8 | Slot |
| NB-350-36-W/R16* | 2 | 36 | 14-4 | 350kcmil-6 | 2-17/32 | 4-23/32 | 2-17/32 | 10-32 | 3/8 | Slot |
| NB-350-42 | 1 | 42 | 14-4 | 350kcmil-6 | 1-17/32 | 5-11/32 | 2-17/32 | 10-32 | 3/8 | Slot |
| NB-350-42-W/R16* | 2 | 42 | 14-4 | 350kcmil-6 | 2-17/32 | 5-11/32 | 2-17/32 | 10-32 | 3/8 | Slot |

All wire sizes, unless noted otherwise, are American Wire Gauge (AWG)

* Part includes phenolic mounting block R-16

Tested to UL 486A/B, UL File E6207

Aluminum Neutral Bars

Dual Rated

Conductor Range: #4-#14



TYPE NBAS

Features

- Manufactured from high strength aluminum alloy
- Electro-tin plated
- Dual rated
- Assemblies available with 2-231 circuits
- UL Recognized for grounding and power, and CSA Certified

Benefits

- Provides maximum conductivity
- Low contact resistance
- Use with both copper and aluminum conductors
- Application versatility
- Ensures reliability

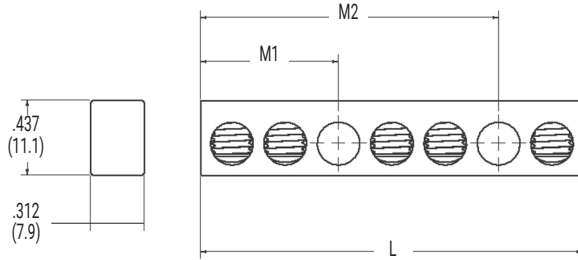

| Catalog Number | Number of Circuits | Mounting Hole Locations ¹ in. (mm) | | Screw type | Configuration | Dimensions in. (mm) |
|----------------|--------------------|-----------------------------------------------|--------------|------------|---------------|---------------------|
| | | M1 | M2 | | | L |
| NBAS-002-1-A | 2 | 0.492 (12.5) | - - | A | ●○● | 0.984 (25.0) |
| NBAS-002-1-B | 2 | 0.492 (12.5) | - - | B | ●○● | 0.984 (25.0) |
| NBAS-003-1-A | 3 | 0.804 (20.4) | - - | A | ●●○● | 1.296 (32.9) |
| NBAS-003-1-B | 3 | 0.804 (20.4) | - - | B | ●●○● | 1.296 (32.9) |
| NBAS-004-1-B | 4 | 0.804 (20.4) | - - | B | ●●○●● | 1.608 (40.8) |
| NBAS-004-2-B | 4 | 0.180 (4.6) | 1.740 (44.2) | B | ○●●●●○ | 1.920 (48.8) |
| NBAS-006-1-B | 6 | 1.116 (28.3) | - - | B | ●●●○●● | 2.232 (56.7) |
| NBAS-008-2-A | 8 | 0.492 (12.5) | 2.676 (68.0) | A | ●○●●●●●○● | 3.168 (80.5) |
| NBAS-009-2-A | 9 | 0.180 (4.6) | 3.300 (83.8) | A | ○●●●●●●●○△ | 3.792 (96.3) |
| NBAS-010-1-B | 10 | 2.052 (52.1) | - - | B | ●●●●△○△●●●● | 4.104 (104.2) |
| NBAS-012-1-B | 12 | 2.364 (60.0) | - - | B | ●●●●△○△●●●● | 4.728 (120.1) |
| NBAS-012-2-A | 12 | 1.116 (28.3) | 3.300 (83.8) | A | ●●●○●●●●○●●● | 4.416 (112.2) |
| NBAS-013-2-A | 13 | 1.116 (28.3) | 3.612 (91.7) | A | ●●●○●●●●●○●●● | 4.728 (120.1) |
| NBAS-014-1-B | 14 | 2.676 (60.0) | - - | B | ●●●●△○△●●●●● | 5.354 (136.0) |
| NBAS-192-0-A* | 192 | - - | - - | A | ● x 192 | 60.000 (1524.0) |
| NBAS-192-0-B | 192 | - - | - - | B | ● x 192 | 60.000 (1524.0) |
| NBAS-231-0-A* | 231 | - - | - - | A | ● x 231 | 72.000 (1828.8) |
| NBAS-231-0-B | 231 | - - | - - | B | ● x 231 | 72.000 (1828.8) |



¹ Mounting holes have a diameter of 0.203 in. (5.2mm)
 All wire sizes, unless noted otherwise, are American Wire Gauge (AWG)
 * Screws are provided unassembled
 Tested to UL 486A/B, UL File E6207 and CSA C22.2 No. 65-03
 Tested to UL 467, UL File E6207

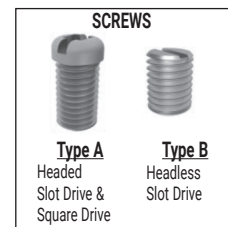
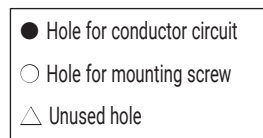

Aluminum Neutral Bars

Extended Conductors

Conductor Range: #6-#14 and 1/0-#14



TYPE NBAE

Features

- Manufactured from high strength aluminum alloy
- Electro-tin plated
- Dual rated
- Assemblies available with 6-123 circuits
- UL Recognized for grounding and power, and CSA Certified

Benefits

- Provides maximum conductivity
- Low contact resistance
- Use with both copper and aluminum conductors
- Application versatility
- Ensures reliability

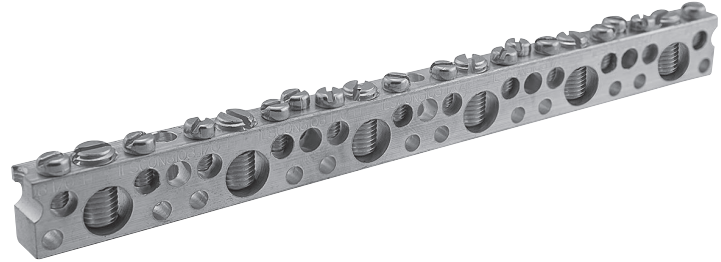
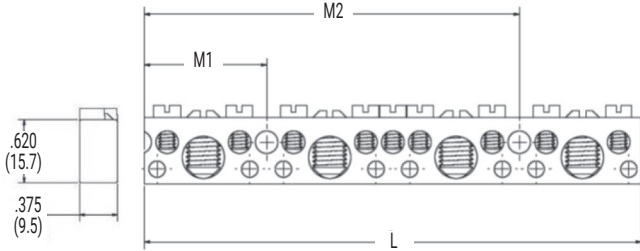

| Catalog Number | Number of Large Circuits ¹ | Number of Small Circuits ² | Mounting Hole Locations ³ in. (mm) | | Dimensions in. (mm) |
|----------------|---------------------------------------|---------------------------------------|-----------------------------------------------|---------------|---------------------|
| | | | M1 | M2 | |
| NBAE-0204-1 | 2 | 4 | 1.133 (28.8) | - - | 2.265 (57.5) |
| NBAE-0307-1 | 3 | 7 | 2.305 (58.5) | - - | 3.438 (87.3) |
| NBAE-0409-2 | 4 | 9 | 1.133 (28.8) | 3.477 (88.3) | 4.609 (117.1) |
| NBAE-0410-1 | 4 | 10 | 2.305 (58.5) | - - | 4.609 (117.1) |
| NBAE-0512-2 | 5 | 12 | 2.305 (58.5) | 4.648 (118.1) | 5.781 (146.8) |
| NBAE-0615-2 | 6 | 15 | 3.477 (88.3) | 5.821 (147.9) | 6.954 (176.6) |
| NBAE-0924-2 | 9 | 24 | 2.305 (58.5) | 9.336 (237.1) | 10.468 (265.9) |
| NBAE-1233-2 | 12 | 33 | 5.820 (147.8) | 8.164 (207.4) | 13.986 (355.2) |
| NBAE-3192-0 | 31 | 92 | - - | - - | 36.250 (920.8) |

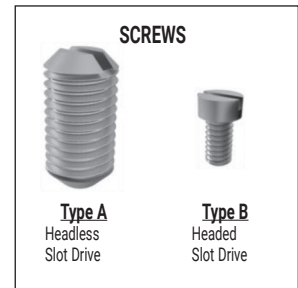

G

¹ Large Circuits have a conductor range of 1/0-14AWG

² Small Circuits have a conductor range of 6-14AWG

³ Mounting holes have a diameter of 0.203 in. (5.2mm)

| Catalog Number | Configuration |
|----------------|---------------------------------------------|
| NBAE-0204-1 | ★●★○★●★ |
| NBAE-0307-1 | ★●★●★●★○★●★ |
| NBAE-0409-2 | ★●★○★●★●★●★●★○★●★ |
| NBAE-0410-1 | ★●★●★●★○★●★●★●★ |
| NBAE-0512-2 | ★●★●★●★○★●★●★●★○★●★ |
| NBAE-0615-2 | ★●★●★●★●★○★●★●★●★○★●★ |
| NBAE-0924-2 | ★●★●★●★○★●★●★●★●★●★●★●★●★●★●★●★○★●★ |
| NBAE-1233-2 | ★●★●★●★●★●★●★●★●★●★○★●★●★●★○★●★●★●★●★●★●★●★ |
| NBAE-3192-0 | ★●★●★●.....★●★● x 28★●★● |

All wire sizes, unless noted otherwise, are American Wire Gauge (AWG)
 Tested to UL 486A/B, UL File E6207 and CSA C22.2 No. 65-03
 Tested to UL 467, UL File E6207

★ Hole for small circuit
 ● Hole for large circuit
 ○ Hole for mounting screw

Neutral Bar Adapter

RoHS
Compliant



TYPE NBST

Features

- Connects a 2/0-14 conductor to a neutral bar
- Seamless stabs
- Conductor entry at 90° or parallel to neutral bar
- Mounts to solar nodes and neutral bars with hole spacing from .300 in to .350 in
- Hex socket screw included
- Manufactured from high strength aluminum
- Electro-tin plated
- UL 486 A/B and UL 467 Recognized, 90° C/194° F

Benefits

- Enables connection of a larger conductor for application versatility
- Provide dual current path for reliability and cool operation
- Multiple conductor orientation
- For diverse field applications
- Offers higher torque rating for reliability
- Suitable for use with copper or aluminum conductors
- Provides low contact resistance
- For power and grounding applications

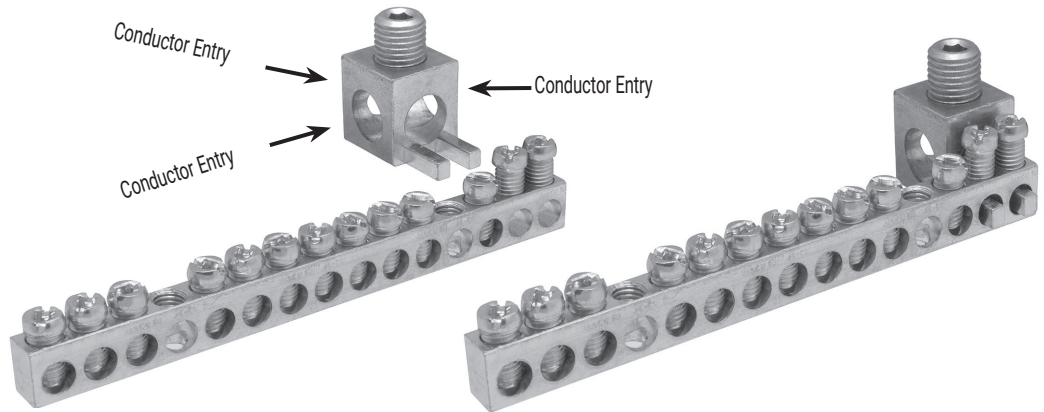
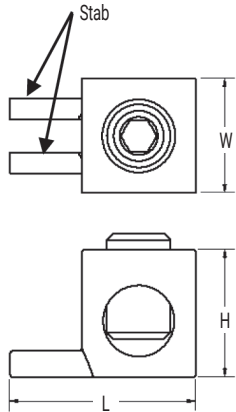

G

| Catalog Number | Wire Range | Dimensions - in. (mm) | | | Hex Size |
|----------------|------------|-----------------------|--------------|--------------|----------|
| | | D | W | J | |
| NBST-2/0 | 2/0-14 | 1.140 (29.0) | 0.700 (17.8) | 0.780 (19.8) | 3/16 |

UL Recognized for use with nVent ILSCO

| Neutral Bars | Solar Nodes |
|--------------|-------------|
| NB-350 | SCNL |
| NBAS | SCNM |

All wire sizes, unless noted otherwise, are American Wire Gauge (AWG)
De-Ox oxide inhibitor is recommended for all aluminum terminations

Grounding Kits

Copper Bus Bars

TYPE BBFC

Features

- Bars manufactured from copper
- Supplied with insulators, brackets & mounting hardware
- Stainless steel mounting bracket
- Large thread insulator mounting hardware
- Common bracket mounting

Benefits

- Ensures maximum conductivity and strength
- Out of box ready for installation. Lock washers prevent loosening of insulator bolts
- Corrosion resistance
- Ideal for heavy duty service
- Simplicity. Common pattern dimension fits all

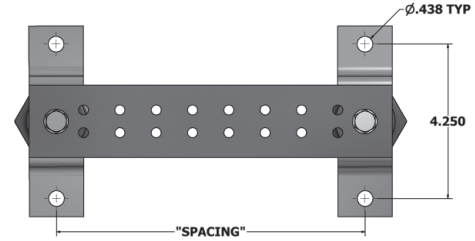
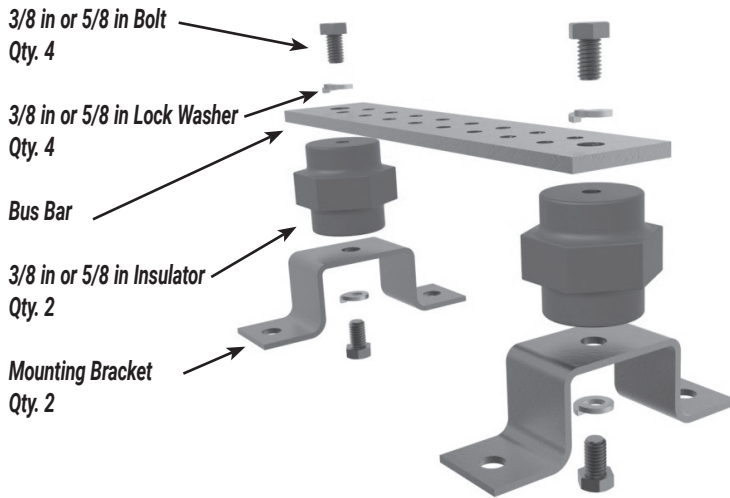

Mounting Bracket Hole Pattern

| Catalog Number | Insulator | Spacing | Dimensions (in.) | | |
|-------------------|----------------|---------|------------------|------|------|
| | | | L | W | T |
| BBFC-2-10-16-KIT | (2) 2500V, 3/8 | 8.50 | 10.00 | 2.00 | 0.25 |
| BBFC-2-24-36-KIT | (2) 2500V, 3/8 | 22.00 | 24.00 | 2.00 | 0.25 |
| BBFC-4-10-22A-KIT | (2) 2500V, 3/8 | 8.50 | 10.00 | 4.00 | 0.25 |
| BBFC-4-10-22B-KIT | (2) 2500V, 3/8 | 8.50 | 10.00 | 4.00 | 0.25 |
| BBFC-4-12-KIT | (2) 2500V, 3/8 | 10.50 | 12.00 | 4.00 | 0.25 |
| BBFC-4-12-18-KIT | (2) 2500V, 3/8 | 10.50 | 12.00 | 4.00 | 0.25 |
| BBFC-4-12-24-KIT | (2) 2500V, 3/8 | 10.50 | 12.00 | 4.00 | 0.25 |
| BBFC-4-16-24-KIT | (2) 3400V, 5/8 | 14.50 | 16.00 | 4.00 | 0.25 |
| BBFC-4-16-32-KIT | (2) 2500V, 3/8 | 14.50 | 16.00 | 4.00 | 0.25 |
| BBFC-4-20-KIT | (2) 3400V, 5/8 | 18.50 | 20.00 | 4.00 | 0.25 |
| BBFC-4-20-18-KIT | (2) 3400V, 5/8 | 18.50 | 20.00 | 4.00 | 0.25 |
| BBFC-4-20-68-KIT | (2) 3400V, 5/8 | 18.50 | 20.00 | 4.00 | 0.25 |
| BBFC-4-24-KIT | (2) 2500V, 3/8 | 22.50 | 24.00 | 4.00 | 0.25 |
| BBFC-4-24-36-KIT | (2) 2500V, 3/8 | 22.50 | 24.00 | 4.00 | 0.25 |



Grounding Copper Bus Bars



TYPE BBFC

Features

- Manufactured from copper
- Industry standard
- Master grounding point
- Multiple connection points

Benefits

- Ensures maximum conductivity and strength
- Assemble & install
- Protects equipment from incoming surges
- Accommodates NEMA and conventional lug mountings. Eliminates miss-wiring which can lead to EMI immunity issues



Fig. 1



Fig. 2



Fig. 3

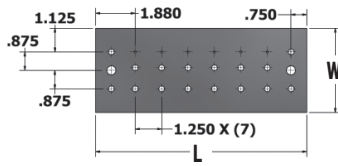

Fig. 4

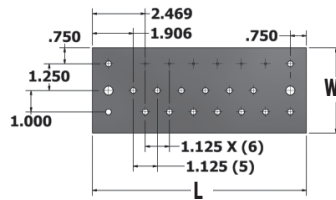

Fig. 5

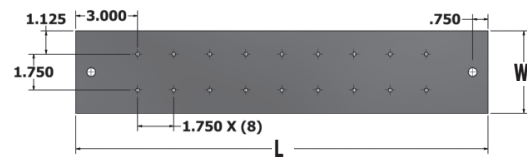

Fig. 6

G

| Catalog Number | Figure Number | Insulator Mounting Size | Number of Mounting Points | Hole Size | Dimensions (in.) | | |
|----------------|---------------|-------------------------|---------------------------|-----------------------------|------------------|------|------|
| | | | | | L | W | T |
| BBFC-4-12 | 1 | 3/8 | none | none | 12.00 | 4.00 | 0.25 |
| BBFC-4-20 | 2 | 5/8 | none | none | 20.00 | 4.00 | 0.25 |
| BBFC-4-24 | 3 | 3/8 | none | none | 24.00 | 4.00 | 0.25 |
| BBFC-4-10-22A | 4 | 3/8 | (6) | 6-32 Threaded 0.281 Dia. | 10.00 | 4.00 | 0.25 |
| BBFC-4-10-22B | 5 | 3/8 | (6) | 6-32 Threaded 0.281 Dia. | 10.00 | 4.00 | 0.25 |
| BBFC-4-20-18 | 6 | 5/8 | (18) | 1/4-20 Threaded | 20.00 | 4.00 | 0.25 |

Grounding Copper Bus Bars

TYPE BBFC

Features

- Manufactured from copper
- Industry standard
- Master grounding point
- Multiple connection points

Benefits

- Ensures maximum conductivity and strength
- Assemble & install
- Protects equipment from incoming surges
- Accommodates NEMA and conventional lug mountings. Eliminates miss-wiring which can lead to EMI immunity issues

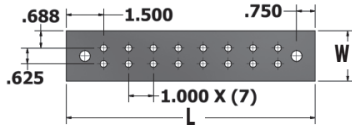

Fig. 1

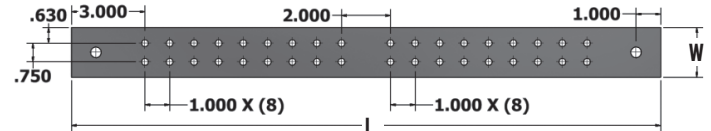

Fig. 2

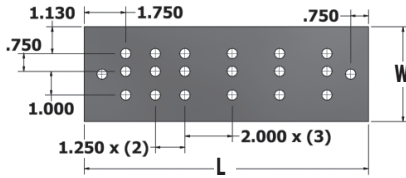

Fig. 3

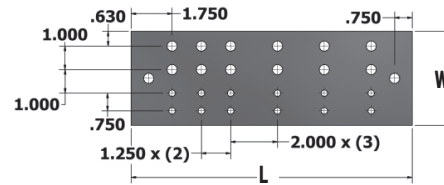

Fig. 4

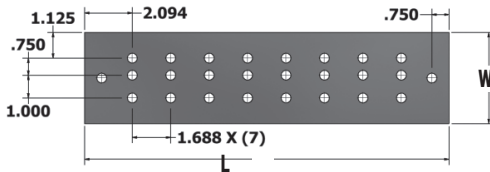

Fig. 5

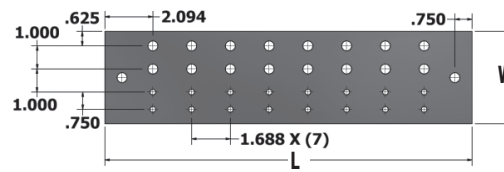

Fig. 6

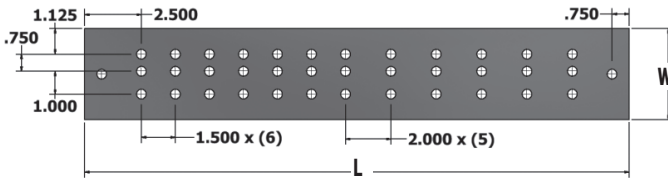

Fig. 7

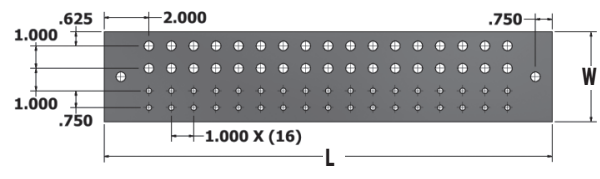

Fig. 8



| Catalog Number | Figure Number | Insulator Mounting Size | Number of Mounting Points | Hole Size | Dimensions (in.) | | |
|----------------|---------------|-------------------------|---------------------------|--------------------------|------------------|------|------|
| | | | | | L | W | T |
| BBFC-2-10-16 | 1 | 3/8 | (16) | 0.281 Dia. | 10.00 | 2.00 | 0.25 |
| BBFC-2-24-36 | 2 | 3/8 | (36) | 0.281 Dia. | 24.00 | 2.00 | 0.25 |
| BBFC-4-12-18 | 3 | 3/8 | (18) | 0.437 Dia. | 12.00 | 4.00 | 0.25 |
| BBFC-4-12-24 | 4 | 3/8 | (12) | 0.437 Dia. 0.281 Dia. | 12.00 | 4.00 | 0.25 |
| BBFC-4-16-24 | 5 | 5/8 | (24) | 0.437 Dia. | 16.00 | 4.00 | 0.25 |
| BBFC-4-16-32 | 6 | 3/8 | (16) | 0.437 Dia. 0.250 Dia. | 16.00 | 4.00 | 0.25 |
| BBFC-4-24-36 | 7 | 3/8 | (36) | 0.437 Dia. | 24.00 | 4.00 | 0.25 |
| BBFC-4-20-68 | 8 | 5/8 | (34) | 0.437 Dia. 0.250 Dia. | 20.00 | 4.00 | 0.25 |

Grounding Copper Bus Bars



TYPE BBFC

Features

- Manufactured from copper
- Industry standard
- Rack grounding point
- Multiple connection points

Benefits

- Ensures maximum conductivity and strength
- Assemble & install
- Optimal for telecommunication systems
- Accommodates NEMA and conventional lug mountings. Eliminates miss-wiring which can lead to EMI immunity issues

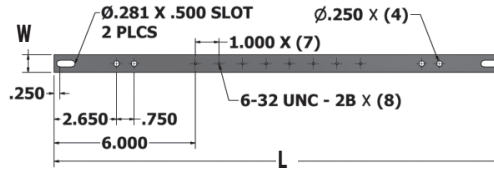

Fig. 1

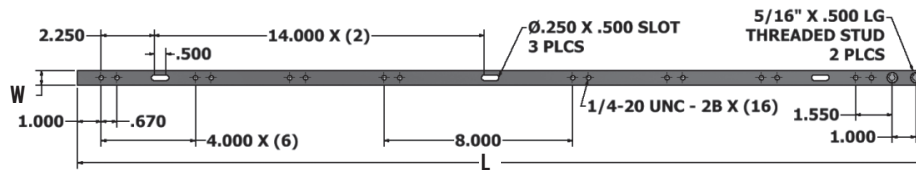

Fig. 2

G

| Catalog Number | Figure Number | Dimensions (in.) | | |
|-------------------|---------------|------------------|------|-------|
| | | L | W | T |
| BBFC-34-19-12-316 | 1 | 19.00 | 0.75 | 0.187 |
| BBFC-1-36-16 | 2 | 36.00 | 1.00 | 0.250 |
| BBFC-58-36-16 | 2 | 36.00 | 0.63 | 0.250 |

Aluminum T-Slot Bus Bar

Single Slot

RoHS
Compliant



TYPE BBTA

Features

- T-slot accommodates hex, square & 1/4-turn bolt heads
- Slot available on full length of bar
- Upward pointing bolt threads
- Recessed insulator mounting hardware
- 1.6 kA continuous current rating
- Anti-turn slot designed to function with ATTA-2/0-12, ATTA-350-12, ATTA-600-12, ATTA-1000-12
- Manufactured from high strength aluminum alloy
- Electro-tin plated
- Supplied with countersunk cap screws
- Installation will not require current protective device up to 65 kA SCCR rating
- Patent 9,698,578

Benefits

- Prevents bolt rotation for one handed connector mounting
- Place connectors anywhere on the bar
- Eliminates potential for electrical arc underneath bar
- Use 100% of bar length for mounting connectors
- Eases certification efforts by using UL Recognized components
- Aligned connection for cross-wise and adjacent connector placement
- Suitable for use with copper or aluminum connectors
- Low contact resistance
- Bar mounting surface free of connection obstacles

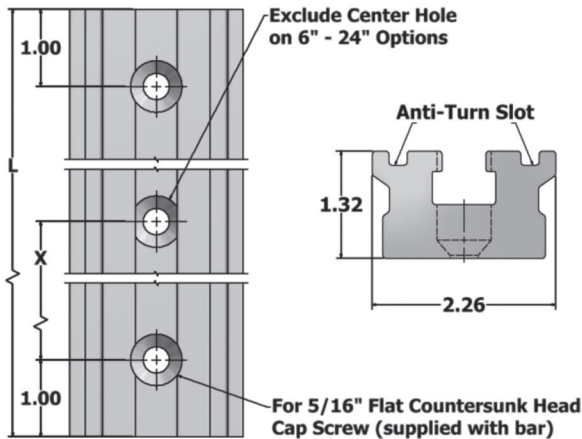

Connector Mounting Hardware

Commercially Available*

| Bolt Type | Bolt Length (in.) | For Use With |
|------------------------------------|----------------------|-----------------------------------------------------------------------------|
| 1/2 in Diameter Stainless Steel | | |
| HEX Bolt <i>ASME B18.2.1</i> | 1.25 1.50 2.75 | Compression/mechanical lugs Panel board lugs Stacked compression lugs |
| Square Bolt <i>ASME B18.2.1</i> | 1.25 1.50 2.75 | Compression/mechanical lugs Panel board lugs Stacked compression lugs |

nVent ILSCO Connector Mounting Hardware*

| 1/4 Turn Bolt | Bolt Length (in.) | For Use With |
|---------------|-------------------|-----------------------------|
| E1607C01Z | 1.25 | Compression/mechanical lugs |
| E1607C02Z | 1.50 | Panel board lugs |
| E1607C03Z | 2.75 | Stacked compression lugs |

* Mounting hardware optional, not supplied with bus bar



| Catalog Number | Number of Mounting Holes | Dimensions - in. (mm) | |
|--------------------|--------------------------|-----------------------|---------------|
| | | L | X |
| BBTA-1T-1600-00600 | 2 | 6.00 (152.4) | - - |
| BBTA-1T-1600-01200 | 2 | 12.00 (304.8) | - - |
| BBTA-1T-1600-01800 | 2 | 18.00 (457.2) | - - |
| BBTA-1T-1600-02400 | 2 | 24.00 (609.6) | - - |
| BBTA-1T-1600-03000 | 3 | 30.00 (762.0) | 14.00 (355.6) |
| BBTA-1T-1600-03600 | 3 | 36.00 (914.4) | 17.00 (431.8) |

Recognized to UL 67, UL File E485264, UL Listed to UL467, UL File E34440

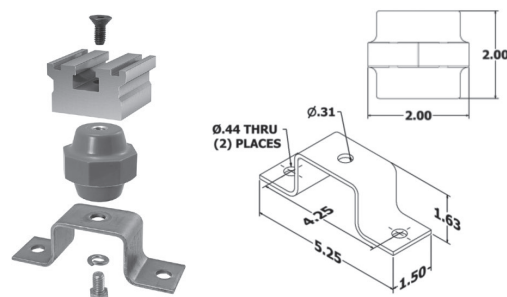

Optional Insulator Mounting Kit

| Kit Catalog Number | Voltage | Short Circuit Current Rating (SCCR) | For Use With |
|--------------------|---------|-------------------------------------|-------------------------------------------------------------------------------------------------------------------------------------------------------|
| INS-516K | 2,500 V | 65 kA | (1) Mounting Bracket (1) 5/16-18 Insulator (1) Split Washer (1) 5/16-18 - 3/16 Flat Countersunk Head Cap Screw (1) 5/16-18 - 1/2 Hex Bolt |

Aluminum T-Slot Bus Bar

Double Slot

RoHS
Compliant



TYPE BBTA

Features

- T-slots accommodates hex, square & 1/4-turn bolt heads
- Slots available on full length of bar
- Upward pointing bolt threads
- Recessed insulator mounting hardware
- 3 kA continuous current rating
- Anti-turn slot designed to function with ATTA-2/0-12, ATTA-350-12, ATTA-600-12, ATTA-1000-12
- Double T-slot
- Manufactured from high strength aluminum alloy
- Electro-tin plated
- Supplied with countersunk cap screws
- Installation will not require current protective device up to 65 kA SCCR rating
- Patent 9,698,578

Benefits

- Prevents bolt rotation for one handed connector mounting
- Place connectors anywhere on the bar
- Eliminates potential for electrical arc underneath bar
- Use 100% of bar length for mounting connectors
- Eases certification efforts by using UL Recognized components
- Aligned connection for cross-wise and adjacent connector placement
- Enables 2x wire placement for greater connector density
- Suitable for use with copper or aluminum connectors
- Low contact resistance
- Bar mounting surface free of connection obstacles
- Installation will not require current protective device up to 65 kA SCCR rating

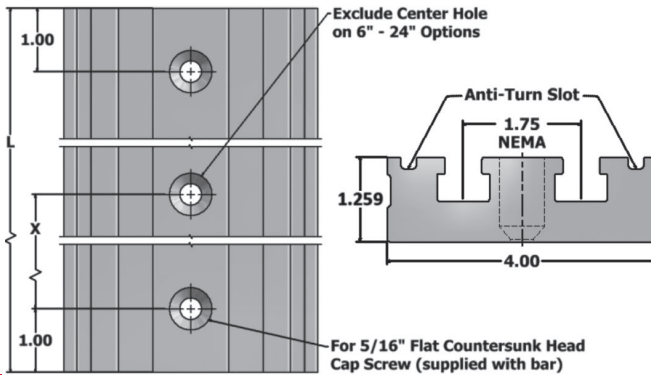

Connector Mounting Hardware

Commercially Available*

| Bolt Type | Bolt Length (in.) | For Use With |
|---------------------------------|----------------------|-----------------------------------------------------------------------------|
| 1/2 in Diameter Stainless Steel | | |
| HEX Bolt ASME B18.2.1 | 1.25 1.50 2.75 | Compression/mechanical lugs Panel board lugs Stacked compression lugs |
| Square Bolt ASME B18.2.1 | 1.25 1.50 2.75 | Compression/mechanical lugs Panel board lugs Stacked compression lugs |

nVent ILSCO Connector Mounting Hardware*

| 1/4 Turn Bolt | Bolt Length (in.) | For Use With |
|---------------|-------------------|-----------------------------|
| E1607C01Z | 1.25 | Compression/mechanical lugs |
| E1607C02Z | 1.50 | Panel board lugs |
| E1607C03Z | 2.75 | Stacked compression lugs |

* Mounting hardware optional, not supplied with bus bar

G

Accessories

| Catalog Number | Height (H) | Description |
|-------------------------|------------|---------------------------|
| Stacking Adaptor | | |
| ASL-250 | 0.75 | Wire range - 250kcmil-1/0 |
| ASL-750 | 1.25 | Wire range - 750kcmil-1/0 |

| Catalog Number | Number of Mounting Holes | Dimensions - in. (mm) | |
|--------------------|--------------------------|-----------------------|---------------|
| | | L | X |
| BBTA-2T-3000-00600 | 2 | 6.00 (152.4) | - - |
| BBTA-2T-3000-01200 | 2 | 12.00 (304.8) | - - |
| BBTA-2T-3000-01800 | 2 | 18.00 (457.2) | - - |
| BBTA-2T-3000-02400 | 2 | 24.00 (609.6) | - - |
| BBTA-2T-3000-03000 | 3 | 30.00 (762.0) | 14.00 (355.6) |
| BBTA-2T-3000-03600 | 3 | 36.00 (914.4) | 17.00 (431.8) |

Recognized to UL 67, UL File E485264, UL Listed to UL467, UL File E34440

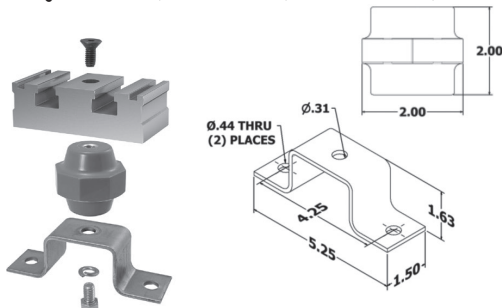

Optional Insulator Mounting Kit

| Kit Catalog Number | Voltage | Short Circuit Current Rating (SCCR) | For Use With |
|--------------------|---------|-------------------------------------|-------------------------------------------------------------------------------------------------------------------------------------------------------|
| INS-516K | 2,500 V | 65 kA | (1) Mounting Bracket (1) 5/16-18 Insulator (1) Split Washer (1) 5/16-18 - 3/16 Flat Countersunk Head Cap Screw (1) 5/16-18 - 1/2 Hex Bolt |

Copper T-Slot Bus Bar

Single Slot

RoHS
Compliant



TYPE BBTC

Features

- T-slot accommodates hex, square & 1/4-turn bolt heads
- Slot available on full length of bar
- Upward pointing bolt threads
- Recessed insulator mounting hardware
- 1.6 kA continuous current rating
- Anti-turn slot designed to function with ATTA-2/0-12, ATTA-350-12, ATTA-600-12, ATTA-1000-12
- Manufactured from high strength copper alloy
- Electro-tin plated
- Supplied with countersunk cap screws
- Installation will not require current protective device up to 65 kA SCCR Rating
- Patent 9,698,578

Benefits

- Prevents bolt rotation for one handed connector mounting
- Place connectors anywhere on the bar
- Eliminates potential for electrical arc underneath bar
- Use 100% of bar length for mounting connectors
- Eases certification efforts by using UL Recognized components
- Aligned connection for cross-wise and adjacent connector placement
- Suitable for use with copper or aluminum connectors
- Low contact resistance
- Bar mounting surface free of connection obstacles

Connector Mounting Hardware

Commercially Available*

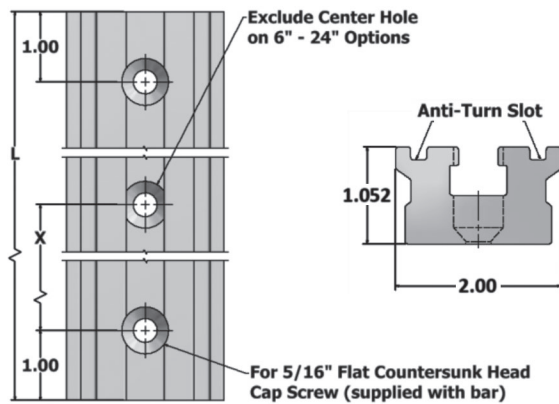

| Bolt Type | Bolt Length (in.) | For Use With |
|------------------------------------|----------------------|-----------------------------------------------------------------------------|
| 1/2 in Diameter Stainless Steel | | |
| HEX Bolt <i>ASME B18.2.1</i> | 1.25 1.50 2.75 | Compression/mechanical lugs Panel board lugs Stacked compression lugs |
| Square Bolt <i>ASME B18.2.1</i> | 1.25 1.50 2.75 | Compression/mechanical lugs Panel board lugs Stacked compression lugs |

nVent ILSCO Connector Mounting Hardware*

| 1/4 Turn Bolt | Bolt Length (in.) | For Use With |
|---------------|-------------------|-----------------------------|
| E1607C01Z | 1.25 | Compression/mechanical lugs |
| E1607C02Z | 1.50 | Panel board lugs |
| E1607C03Z | 2.75 | Stacked compression lugs |

* Mounting hardware optional, not supplied with bus bar



| Catalog Number | Number of Mounting Holes | Dimensions - in. (mm) | |
|--------------------|--------------------------|-----------------------|---------------|
| | | L | X |
| BBTC-1T-1600-00600 | 2 | 6.00 (152.4) | - - |
| BBTC-1T-1600-01200 | 2 | 12.00 (304.8) | - - |
| BBTC-1T-1600-01800 | 2 | 18.00 (457.2) | - - |
| BBTC-1T-1600-02400 | 2 | 24.00 (609.6) | - - |
| BBTC-1T-1600-03000 | 3 | 30.00 (762.0) | 14.00 (355.6) |
| BBTC-1T-1600-03600 | 3 | 36.00 (914.4) | 17.00 (431.8) |
| BBTC-1T-1600-04800 | 3 | 48.00 (1219.2) | 23.00 (584.2) |
| BBTC-1T-1600-07200 | 0 | 72.00 (1828.8) | - - |
| BBTC-1T-1600-09600 | 0 | 96.00 (2438.4) | - - |
| BBTC-1T-1600-12000 | 0 | 120.00 (3048.4) | - - |
| BBTC-1T-1600-14400 | 0 | 144.00 (3657.6) | - - |

Recognized to UL 67, UL File E485264, UL Listed to UL467, UL File E34440

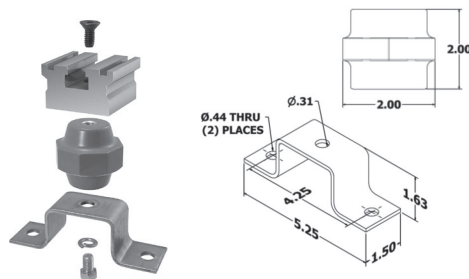

Optional Insulator Mounting Kit

| Kit Catalog Number | Voltage | Short Circuit Current Rating (SCCR) | For Use With |
|--------------------|---------|-------------------------------------|-------------------------------------------------------------------------------------------------------------------------------------------------------|
| INS-516K | 2,500 V | 65 kA | (1) Mounting Bracket (1) 5/16-18 Insulator (1) Split Washer (1) 5/16-18 - 3/16 Flat Countersunk Head Cap Screw (1) 5/16-18 - 1/2 Hex Bolt |

Copper T-Slot Bus Bar

Double Slot

RoHS
Compliant



TYPE BBTC

Features

- T-slots accommodates hex, square & 1/4-turn bolt heads
- Slots available on full length of bar
- Upward pointing bolt threads
- Recessed insulator mounting hardware
- 3 kA continuous current rating
- Anti-turn slot designed to function with ATTA-2/0-12, ATTA-350-12, ATTA-600-12, ATTA-1000-12
- Double T-slot
- Manufactured from high strength copper alloy
- Electro-tin plated
- Supplied with countersunk cap screws
- Installation will not require current protective device up to 65 kA SCCR Rating
- Patent 9,698,578

Benefits

- Prevents bolt rotation for one handed connector mounting
- Place connectors anywhere on the bar
- Eliminates potential for electrical arc underneath bar
- Use 100% of bar length for mounting connectors
- Eases certification efforts by using UL Recognized components
- Aligned connection for cross-wise and adjacent connector placement
- Enables 2x wire placement for greater connector density
- Suitable for use with copper or aluminum connectors
- Low contact resistance
- Bar mounting surface free of connection obstacles

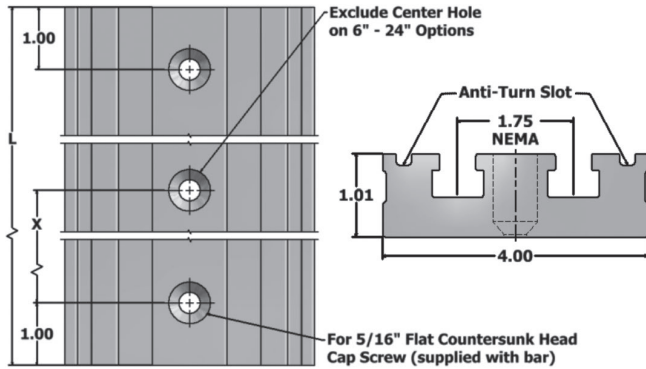

Connector Mounting Hardware

Commercially Available*

| Bolt Type | Bolt Length (in.) | For Use With |
|---------------------------------|----------------------|-----------------------------------------------------------------------------|
| 1/2 in Diameter Stainless Steel | | |
| HEX Bolt ASME B18.2.1 | 1.25 1.50 2.75 | Compression/mechanical lugs Panel board lugs Stacked compression lugs |
| Square Bolt ASME B18.2.1 | 1.25 1.50 2.75 | Compression/mechanical lugs Panel board lugs Stacked compression lugs |

nVent ILSCO Connector Mounting Hardware*

| 1/4 Turn Bolt | Bolt Length (in.) | For Use With |
|---------------|-------------------|-----------------------------|
| E1607C01Z | 1.25 | Compression/mechanical lugs |
| E1607C02Z | 1.50 | Panel board lugs |
| E1607C03Z | 2.75 | Stacked compression lugs |

* Mounting hardware optional, not supplied with bus bar

Accessories

G

| Catalog Number | Height (H) | Description |
|-------------------------|------------|---------------------------|
| Stacking Adaptor | | |
| ASL-250 | 0.75 | Wire range - 250kcmil-1/0 |
| ASL-750 | 1.25 | Wire range - 750kcmil-1/0 |

| Catalog Number | Number of Mounting Holes | Dimensions - in. (mm) | |
|--------------------|--------------------------|-----------------------|---------------|
| | | L | X |
| BBTC-2T-3000-00600 | 2 | 6.00 (152.4) | - - |
| BBTC-2T-3000-01200 | 2 | 12.00 (304.8) | - - |
| BBTC-2T-3000-01800 | 2 | 18.00 (457.2) | - - |
| BBTC-2T-3000-02400 | 2 | 24.00 (609.6) | - - |
| BBTC-2T-3000-03000 | 3 | 30.00 (762.0) | 14.00 (355.6) |
| BBTC-2T-3000-03600 | 3 | 36.00 (914.4) | 17.00 (431.8) |
| BBTC-2T-3000-04800 | 3 | 48.00 (1219.2) | 23.00 (584.2) |
| BBTC-2T-3000-07200 | 0 | 72.00 (1828.8) | - - |
| BBTC-2T-3000-09600 | 0 | 96.00 (2438.4) | - - |
| BBTC-2T-3000-12000 | 0 | 120.00 (3048.4) | - - |
| BBTC-2T-3000-14400 | 0 | 144.00 (3657.6) | - - |

Recognized to UL 67, UL File E485264, UL Listed to UL467, UL File E34440

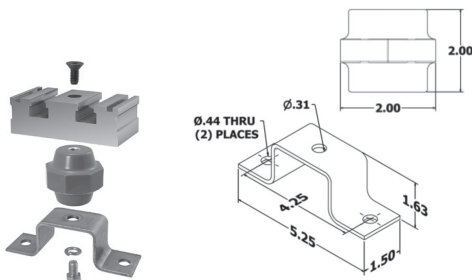

Optional Insulator Mounting Kit

| Kit Catalog Number | Voltage | Short Circuit Current Rating (SCCR) | For Use With |
|--------------------|---------|-------------------------------------|-------------------------------------------------------------------------------------------------------------------------------------------------------|
| INS-516K | 2,500 V | 65 kA | (1) Mounting Bracket (1) 5/16-18 Insulator (1) Split Washer (1) 5/16-18 - 3/16 Flat Countersunk Head Cap Screw (1) 5/16-18 - 1/2 Hex Bolt |

Solar Combiner Node

Lay-In

RoHS
Compliant



TYPE SCNL

Features

- Manufactured from high strength aluminum alloy
- Configuration - 27 inputs and 1 output
- Conductor Input: 4-14
- Conductor Output: 750kcmil-1/0
- Designed for insulators up to 2000V
- For unfused PV source inputs up to 420A CU, 340A AL

Benefits

- Provide maximum conductivity and strength for copper and aluminum conductors
- Application versatility
- Input accepts Class B and C conductors
- Output accepts Class B and C conductors
- Mounting hardware fits variety of commercial insulators

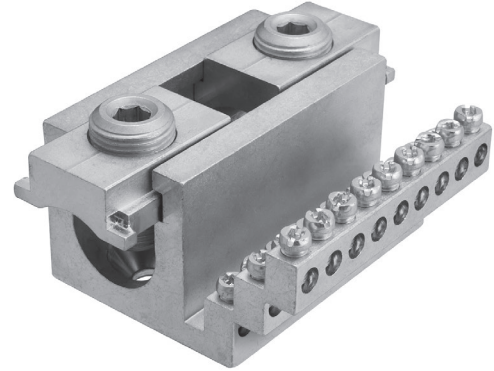
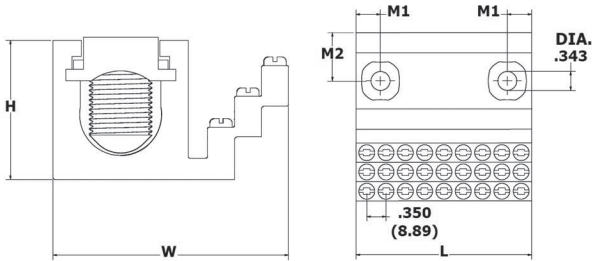

| Catalog Number | Primary | | | | Secondary | | | Dimensions - in. (mm) | | | | |
|----------------|----------------|----------------|--------------------|------------|--------------|--------------------|----------|-----------------------|--------------|--------------|--------------|--------------|
| | Wire Range | Wires Per Hole | Number of Circuits | Screw Type | Wire Range | Number of Circuits | Hex Size | W | H | L | M1 | M2 |
| SCNL-27 | 4-14 10-14+ | 1 2 | 27 54 | Slot/SQ | 750kcmil-1/0 | 1 | 5/16 | 3.050 (77.5) | 1.800 (45.7) | 3.186 (80.9) | 0.443 (11.3) | 0.875 (22.2) |

G

All wire sizes, unless noted otherwise, are American Wire Gauge (AWG)

Two 5/16 dia, 5/16 depth flat-head screws are included for mounting. Insulators sold separately, consult factory for ordering information.

UL/cUL Recognized to UL486A/B, UL File E6207

+ See Information Sheet for other UL approved two wire combinations.

TYPE SCNM

Features

- Manufactured from high strength aluminum alloy
- Configuration - 18 to 42 string inputs; 4 outputs
- Conductor Input: 4-14
- Conductor Output: 1000kcmil-6
- Designed for insulators up to 2000V

Benefits

- Provides maximum conductivity and strength for copper and aluminum conductors
- Application versatility
- Input accepts Class B and C conductors
- Output accepts Class B, C, G, H, I, K, M and DLO conductors
- Mounting hardware fits variety of commercial insulators

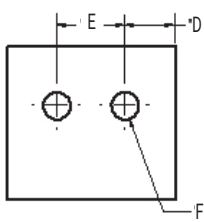

Fig. 1

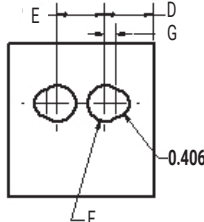

Fig. 2

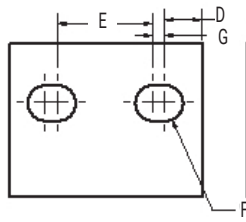

Fig. 3

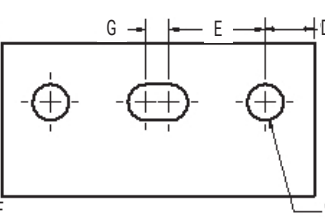

Fig. 4

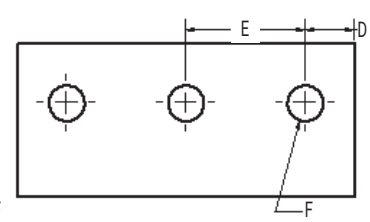
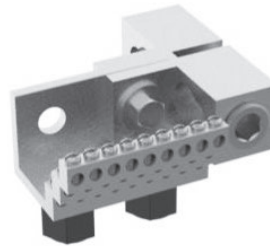
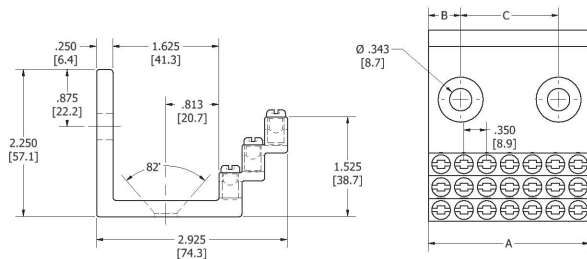
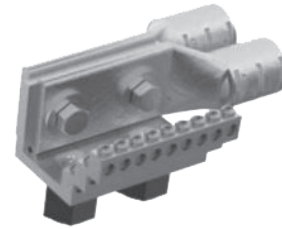

Fig. 5

Lug Mount Configurations (See Figure Number above)



Typical Mechanical
Lug Mount



Typical Compression
Lug Mount

G

| Catalog Number | Lug Mount Figure Number | PV Source Input** | String Input | | Output | | Dimensions - in. (mm) | | | | | | |
|----------------|-------------------------|-------------------|----------------|------------|-----------------|-------------|-----------------------|---------------|---------------|---------------|---------------|---------------|---------------|
| | | | No. of Strings | Wire Range | No. of Circuits | Wire Range | A | B | C | D | E | F | G |
| SCNM-18 | 2 | 540 | 18 | 4-14 | 1-4 | 1000kcmil-6 | 2.136 (54.25) | 0.443 (11.25) | 1.250 (31.75) | 0.718 (18.24) | 0.700 (17.78) | 0.531 (13.49) | 0.150 (3.81) |
| SCNM-21 | 1 | 630 | 21 | 4-14 | 1-4 | 1000kcmil-6 | 2.468 (62.69) | 0.493 (12.52) | 1.500 (38.10) | 0.734 (18.64) | 1.000 (25.40) | 0.406 (10.31) | |
| SCNM-24 | 3 | 720 | 24 | 4-14 | 1-4* | 1000kcmil-6 | 2.836 (72.03) | 0.543 (13.79) | 1.750 (44.45) | 0.543 (13.79) | 1.400 (35.56) | 0.531 (13.49) | 0.175 (4.45) |
| SCNM-27 | 1 | 810 | 27 | 4-14 | 1-4* | 1000kcmil-6 | 3.186 (80.92) | 0.593 (15.06) | 2.000 (50.80) | 0.718 (18.24) | 1.750 (44.45) | 0.531 (13.49) | |
| SCNM-30 | 3 | 900 | 30 | 4-14 | 1-4* | 1000kcmil-6 | 3.536 (89.81) | 0.518 (13.16) | 2.500 (63.50) | 0.718 (18.24) | 1.750 (44.45) | 0.531 (13.49) | 0.175 (4.45) |
| SCNM-33 | 3 | 990 | 33 | 4-14 | 1-4* | 1000kcmil-6 | 3.886 (98.70) | 0.443 (11.25) | 3.000 (76.20) | 0.718 (18.24) | 1.750 (44.45) | 0.531 (13.49) | 0.350 (8.89) |
| SCNM-36 | 3 | 1080 | 36 | 4-14 | 1-4* | 1000kcmil-6 | 4.236 (107.59) | 0.618 (15.70) | 3.000 (76.20) | 0.718 (18.24) | 1.750 (44.45) | 0.531 (13.49) | 0.525 (13.34) |
| SCNM-39 | 4 | 1170 | 39 | 4-14 | 1-4* | 1000kcmil-6 | 4.586 (116.48) | 0.793 (20.14) | 3.000 (76.20) | 0.718 (18.24) | 1.400 (35.56) | 0.531 (13.49) | 0.350 (8.89) |
| SCNM-42 | 5 | 1260 | 42 | 4-14 | 1-4* | 1000kcmil-6 | 4.936 (125.37) | 0.968 (24.59) | 3.000 (76.20) | 0.718 (18.24) | 1.750 (44.45) | 0.531 (13.49) | |

All wire sizes, unless noted otherwise, are American Wire Gauge (AWG)

**For non-fused PV string inputs, 30A per string

Each input hole contains a 1/4 - 28 UNF; slotted/square drive screw

Two 5/16-18 UNC x 1/2 screws are included for mounting to insulators (insulators sold separately, consult Customer Care for information)

*For use with mechanical or compression components; sold separately. NEMA mounting hole configurations

UL/cUL Recognized to UL486A/B, UL File E6207

Surface Bonding Washer

RoHS
Compliant



TYPE SBW

Features

- Manufactured from stainless steel
- Exclusive Viridium plating
- Green color, universal to identify ground
- Conical contact points

Benefits

- Maximum durability in outdoor environments
- Resists galvanic corrosion
- Aids visual inspection
- Penetrates mounting surface, no surface preparation

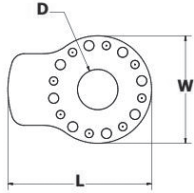

| Catalog Number | Bolt Size* | Dimensions - in. (mm) | | |
|----------------|------------|-----------------------|--------------|--------------|
| | | D | L | W |
| SBW-14 | 1/4 (M6) | 0.281 (7.1) | 1.000 (25.4) | 0.750 (19.1) |
| SBW-516 | 5/16 (M8) | 0.343 (8.7) | 1.000 (25.4) | 0.750 (19.1) |
| SBW-38 | 3/8 (M10) | 0.406 (10.3) | 1.000 (25.4) | 0.750 (19.1) |



UL 467 Listed for grounding and bonding, UL File E34440

UL 2703 Recognized, UL File E354420

* Bolt not included

Surface Bonding Clip

RoHS
Compliant



TYPE SBC

Features

- Manufactured from stainless steel
- Exclusive Viridium plating
- Green color, universal to identify ground
- Conical contact points
- Clips to PV panels

Benefits

- Maximum durability in outdoor environments
- Resists galvanic corrosion
- Aids visual inspection
- Penetrates mounting surface, no surface preparation
- Enables pre-installation onto a PV panel or inserted during PV panel-to-rack attachment

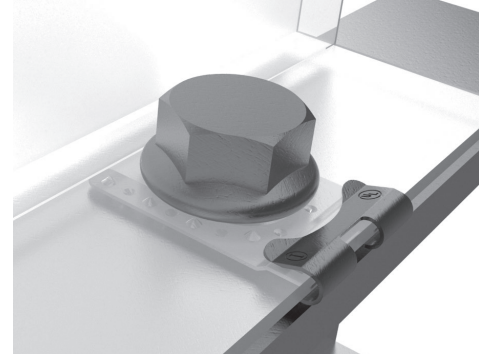
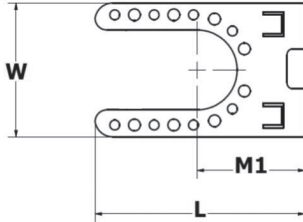

| Catalog Number | Bolt Size* | Dimensions - in. (mm) | | | |
|----------------|------------|-------------------------|--------------|--------------|--------------|
| | | Mounting Clip Thickness | L | W | M1 (minimum) |
| SBC-14 | 1/4 (M6) | 0.050-0.075 (1.3-1.9) | 1.066 (27.1) | 0.687 (17.4) | 0.456 (11.6) |
| SBC-516 | 5/16 (M8) | 0.050-0.075 (1.3-1.9) | 1.066 (27.1) | 0.687 (17.4) | 0.487 (12.4) |
| SBC-38 | 3/8 (M10) | 0.050-0.075 (1.3-1.9) | 1.066 (27.1) | 0.687 (17.4) | 0.518 (13.2) |

G

UL 467 Listed for grounding and bonding, UL File E34440

UL 2703 Recognized, UL File E354420

* Bolt not included

Surface Bonding Jumper



TYPE SBJ

Features

- Cable and ring terminals manufactured from high strength copper alloy
- Bonding washer made from Viridium plated stainless steel
- Green color, universal to identify ground
- Complete jumper assembly

Benefits

- Provides maximum electrical conductivity
- Maximum durability in outdoor environments, resists galvanic corrosion
- Aids visual inspection
- Quick and easy installation, no surface preparation

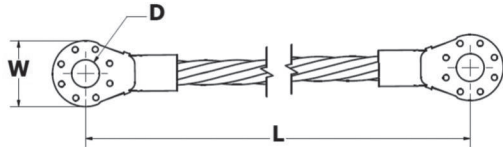

| Catalog Number* | Wire Size | Dimensions - in. (mm) | |
|-----------------|-----------|-----------------------|--------------|
| | | L | W |
| SBJ-X-6 | 6AWG | 6.000 (152.4) | 0.670 (17.0) |
| SBJ-X-712 | 6AWG | 7.500 (190.5) | 0.670 (17.0) |
| SBJ-X-9 | 6AWG | 9.000 (228.6) | 0.670 (17.0) |
| SBJ-X-1012 | 6AWG | 10.500 (266.7) | 0.670 (17.0) |
| SBJ-X-12 | 6AWG | 12.000 (304.8) | 0.670 (17.0) |
| SBJ-X-15 | 6AWG | 15.000 (381.0) | 0.670 (17.0) |
| SBJ-X-18 | 6AWG | 18.000 (457.2) | 0.670 (17.0) |
| SBJ-X-21 | 6AWG | 21.000 (533.4) | 0.670 (17.0) |
| SBJ-X-24 | 6AWG | 24.000 (609.6) | 0.670 (17.0) |
| SBJ-X-28 | 6AWG | 28.000 (711.2) | 0.670 (17.0) |
| SBJ-X-32 | 6AWG | 32.000 (812.8) | 0.670 (17.0) |
| SBJ-X-36 | 6AWG | 36.000 (914.4) | 0.670 (17.0) |
| SBJ-X-40 | 6AWG | 40.000 (1016.0) | 0.670 (17.0) |
| SBJ-X-44 | 6AWG | 44.000 (1117.6) | 0.670 (17.0) |
| SBJ-X-48 | 6AWG | 48.000 (1219.2) | 0.670 (17.0) |
| SBJ-X-54 | 6AWG | 54.000 (1371.6) | 0.670 (17.0) |
| SBJ-X-60 | 6AWG | 60.000 (1524.0) | 0.670 (17.0) |
| SBJ-X-66 | 6AWG | 66.000 (1676.4) | 0.670 (17.0) |
| SBJ-X-72 | 6AWG | 72.000 (1828.8) | 0.670 (17.0) |



*X = Bolt Size

| X Value | D - in. (mm) | Bolt Size |
|---------|--------------|-----------|
| 14 | 0.252 (6.4) | 1/4 (M6) |
| 516 | 0.331 (8.4) | 5/16 (M8) |
| 38 | 0.413 (10.5) | 3/8 (M10) |

All wire sizes, unless noted otherwise, are American Wire Gauge (AWG)

UL 467 Listed for grounding and bonding, UL File E34440

UL 2703 Listed, UL File E354420

* Bolt not included

FX

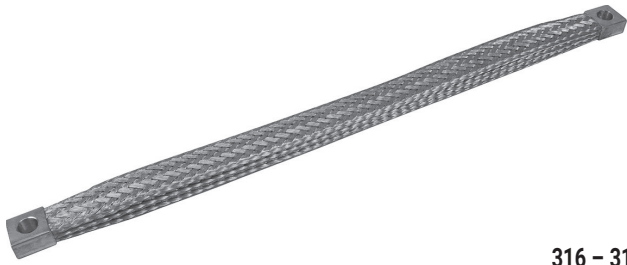

316 - 317

nVent ILSCO FLEX BRAID CONNECTORS

nVent ILSCO manufactures high quality flexible braid electrical connectors for power and grounding applications. Flex braid connectors are ideal for grounding electrical cabinet doors and in situations where vibration exists. This includes generators, turbines, motors, substations and transformers.

nVent ILSCO flex braid connectors are UL Listed and CSA Certified for grounding per UL 467, file E34440.

Flex braids are also commonly used on bus systems and for equipment misalignment solutions.

nVent ILSCO flex braids consist of high quality tin-plated copper braid with seamless copper tube ferrules stamped on the ends. The ferrules have rounded smooth edges to prevent chaffing of braid strands.

nVent ILSCO provides four standard ferrule designs as shown above, but we will be glad to quote custom designs per your specifications.

Flex Braid Connectors

Single Mounting Hole

RoHS
Compliant

UL
LISTED
667P

TYPE
FX

Features

- Manufactured from pure copper braid
- Electro-tin plated
- Seamless pure copper ferrules
- Ferrules clean cut and precision formed to braid
- Flexible braid

Benefits

- Provides superior ground path
- Corrosion resistant
- Low resistance
- Assures permanent low resistance connection
- Compensates for linear expansion, vibration, and other dimensional offset conditions

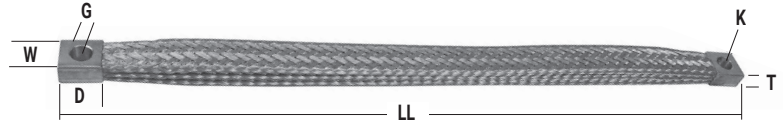
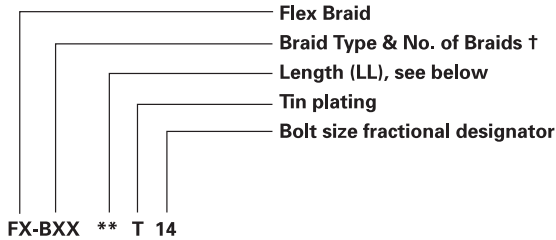

| Catalog Number | Wire Equivalent | Amps | Number of Braids | Dimensions - in. (mm) | | | | | Mounting Hole Dia. K | Bolt Size - in. |
|----------------|-----------------|------|------------------|-----------------------|--------------|--------------|--------------|--------------|----------------------|-----------------|
| | | | | T | W | D | G | | | |
| FX-BD**T12 | 1 AWG | 190 | 1 | 0.130 (3.3) | 1.190 (30.2) | 1.190 (30.2) | 0.595 (15.1) | 0.560 (14.2) | 1/2 | |
| FX-BE**T12 | 3/0 AWG | 340 | 1 | 0.210 (5.3) | 1.250 (31.8) | 1.250 (31.8) | 0.625 (15.9) | 0.560 (14.2) | 1/2 | |
| FX-BF**T12 | 4/0 AWG | 375 | 1 | 0.280 (7.1) | 1.380 (35.1) | 1.380 (35.1) | 0.690 (17.5) | 0.560 (14.2) | 1/2 | |
| FX-BG**T12 | 300 kcmil | 510 | 1 | 0.364 (9.2) | 1.630 (41.4) | 1.630 (41.4) | 0.815 (20.7) | 0.560 (14.2) | 1/2 | |
| FX-B2D**T12 | 154 kcmil | 380 | 2 | 0.210 (5.3) | 1.190 (30.2) | 1.190 (30.2) | 0.595 (15.1) | 0.560 (14.2) | 1/2 | |
| FX-B2E**T12 | 308 kcmil | 530 | 2 | 0.350 (8.9) | 1.250 (31.8) | 1.250 (31.8) | 0.625 (15.9) | 0.560 (14.2) | 1/2 | |
| FX-B2F**T12 | 464 kcmil | 600 | 2 | 0.380 (9.7) | 1.380 (35.1) | 1.380 (35.1) | 0.690 (17.5) | 0.560 (14.2) | 1/2 | |
| FX-B2G**T12 | 600 kcmil | 875 | 2 | 0.500 (12.7) | 1.630 (41.4) | 1.630 (41.4) | 0.815 (20.7) | 0.560 (14.2) | 1/2 | |
| FX-B3D**T12 | 231 kcmil | 470 | 3 | 0.270 (6.9) | 1.190 (30.2) | 1.190 (30.2) | 0.595 (15.1) | 0.560 (14.2) | 1/2 | |
| FX-B3E**T12 | 462 kcmil | 700 | 3 | 0.580 (14.7) | 1.250 (31.8) | 1.250 (31.8) | 0.625 (15.9) | 0.560 (14.2) | 1/2 | |
| FX-B3F**T12 | 696 kcmil | 900 | 3 | 0.590 (15.0) | 1.380 (35.1) | 1.380 (35.1) | 0.690 (17.5) | 0.560 (14.2) | 1/2 | |
| FX-B3G**T12 | 900 kcmil | 1000 | 3 | 0.690 (17.5) | 1.630 (41.4) | 1.630 (41.4) | 0.815 (20.7) | 0.560 (14.2) | 1/2 | |
| FX-B4D**T12 | 308 kcmil | 600 | 4 | 0.390 (9.9) | 1.190 (30.2) | 1.190 (30.2) | 0.595 (15.1) | 0.560 (14.2) | 1/2 | |
| FX-B4E**T12 | 616 kcmil | 875 | 4 | 0.800 (20.3) | 1.250 (31.8) | 1.250 (31.8) | 0.625 (15.9) | 0.560 (14.2) | 1/2 | |
| FX-B4F**T12 | 928 kcmil | 1000 | 4 | 0.870 (22.1) | 1.380 (35.1) | 1.380 (35.1) | 0.690 (17.5) | 0.560 (14.2) | 1/2 | |
| FX-B4G**T12 | 1200 kcmil | 1200 | 4 | 1.000 (25.4) | 1.630 (41.4) | 1.630 (41.4) | 0.815 (20.7) | 0.560 (14.2) | 1/2 | |
| FX-BD06T14 | 1 AWG | 190 | 1 | 0.130 (3.3) | 1.190 (30.2) | 1.190 (30.2) | 0.595 (15.1) | 0.280 (7.1) | 1/4 | |
| FX-BD09T14 | 1 AWG | 190 | 1 | 0.130 (3.3) | 1.190 (30.2) | 1.190 (30.2) | 0.595 (15.1) | 0.280 (7.1) | 1/4 | |
| FX-BD10T14 | 1 AWG | 190 | 1 | 0.130 (3.3) | 1.190 (30.2) | 1.190 (30.2) | 0.595 (15.1) | 0.280 (7.1) | 1/4 | |
| FX-BD12T14 | 1 AWG | 190 | 1 | 0.130 (3.3) | 1.190 (30.2) | 1.190 (30.2) | 0.595 (15.1) | 0.280 (7.1) | 1/4 | |
| FX-BD14T14 | 1 AWG | 190 | 1 | 0.130 (3.3) | 1.190 (30.2) | 1.190 (30.2) | 0.595 (15.1) | 0.280 (7.1) | 1/4 | |
| FX-BE06T716 | 3/0 AWG | 340 | 1 | 0.210 (5.3) | 1.250 (31.8) | 1.250 (31.8) | 0.625 (15.9) | 0.460 (11.7) | 7/16 | |
| FX-BE12T716 | 3/0 AWG | 340 | 1 | 0.210 (5.3) | 1.250 (31.8) | 1.250 (31.8) | 0.625 (15.9) | 0.460 (11.7) | 7/16 | |
| FX-BE18T716 | 3/0 AWG | 340 | 1 | 0.210 (5.3) | 1.250 (31.8) | 1.250 (31.8) | 0.625 (15.9) | 0.460 (11.7) | 7/16 | |
| FX-BE12T58 | 3/0 AWG | 340 | 1 | 0.210 (5.3) | 1.250 (31.8) | 1.250 (31.8) | 0.625 (15.9) | 0.660 (16.8) | 5/8 | |
| FX-BE18T58 | 3/0 AWG | 340 | 1 | 0.210 (5.3) | 1.250 (31.8) | 1.250 (31.8) | 0.625 (15.9) | 0.660 (16.8) | 5/8 | |
| FX-BE24T58 | 3/0 AWG | 340 | 1 | 0.210 (5.3) | 1.250 (31.8) | 1.250 (31.8) | 0.625 (15.9) | 0.660 (16.8) | 5/8 | |
| FX-BF06T716 | 4/0 AWG | 375 | 1 | 0.280 (7.1) | 1.380 (35.1) | 1.380 (35.1) | 0.690 (17.5) | 0.460 (11.7) | 7/16 | |
| FX-BF12T716 | 4/0 AWG | 375 | 1 | 0.280 (7.1) | 1.380 (35.1) | 1.380 (35.1) | 0.690 (17.5) | 0.460 (11.7) | 7/16 | |
| FX-BF18T716 | 4/0 AWG | 375 | 1 | 0.280 (7.1) | 1.380 (35.1) | 1.380 (35.1) | 0.690 (17.5) | 0.460 (11.7) | 7/16 | |
| FX-BG06T716 | 300 kcmil | 510 | 1 | 0.364 (9.2) | 1.630 (41.4) | 1.630 (41.4) | 0.815 (20.7) | 0.460 (11.7) | 7/16 | |
| FX-BG08T716 | 300 kcmil | 510 | 1 | 0.364 (9.2) | 1.630 (41.4) | 1.630 (41.4) | 0.815 (20.7) | 0.460 (11.7) | 7/16 | |
| FX-BG12T716 | 300 kcmil | 510 | 1 | 0.364 (9.2) | 1.630 (41.4) | 1.630 (41.4) | 0.815 (20.7) | 0.460 (11.7) | 7/16 | |

G1

Tested to UL 467, UL File E34440 Amp rating will vary with ambient conditions, orientation of the braid and other service conditions

** Available lengths (LL): 06 in, 09 in, 12 in, 18 in, 24 in, 36 in, 48 in

Contact Customer Care for custom lengths, mounting hole requirements and configurations

† Missing numerical value indicates single braid

Flex Braid Connectors

Double Mounting Hole

RoHS
Compliant



TYPE
FX

Features

- Manufactured from pure copper braid
- Electro-tin plated
- Seamless pure copper ferrules
- Ferrules clean cut and precision formed to braid
- Flexible braid

Benefits

- Provides superior ground path
- Corrosion resistant
- Low resistance
- Assures permanent low resistance connection
- Compensates for linear expansion, vibration, and other dimensional offset conditions

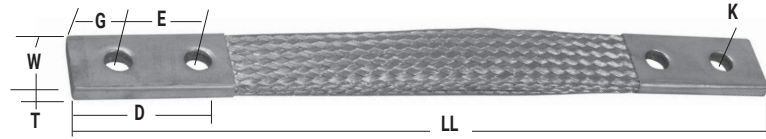
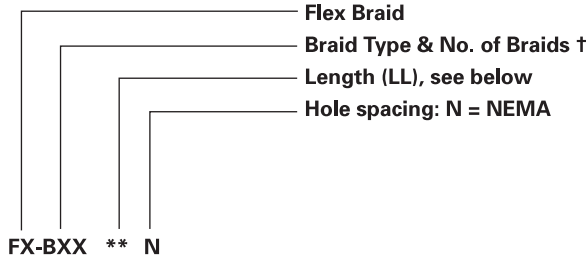

G1

| Catalog Number | Wire Equivalent | Amps | Number of Braids | Dimensions - in (mm) | | | | | Mounting Hole Dia. K | Bolt Size - in. |
|----------------|-----------------|------|------------------|----------------------|--------------|--------------|--------------|--------------|----------------------|-----------------|
| | | | | T | W | D | E | G | | |
| FX-BD** | 1 AWG | 190 | 1 | 0.130 (3.3) | 1.190 (30.2) | 2.500 (63.5) | 1.000 (25.4) | 0.750 (19.1) | 0.410 (10.4) | 3/8 |
| FX-BD**N | 1 AWG | 190 | 1 | 0.130 (3.3) | 1.190 (30.2) | 3.000 (76.2) | 1.750 (44.5) | 0.620 (15.7) | 0.560 (14.2) | 1/2 |
| FX-BE** | 3/0 AWG | 340 | 1 | 0.210 (5.3) | 1.250 (31.8) | 2.500 (63.5) | 1.000 (25.4) | 0.750 (19.1) | 0.410 (10.4) | 3/8 |
| FX-BE**N | 3/0 AWG | 340 | 1 | 0.210 (5.3) | 1.250 (31.8) | 3.000 (76.2) | 1.750 (44.5) | 0.620 (15.7) | 0.560 (14.2) | 1/2 |
| FX-BF** | 4/0 AWG | 375 | 1 | 0.280 (7.1) | 1.380 (35.1) | 2.500 (63.5) | 1.000 (25.4) | 0.750 (19.1) | 0.410 (10.4) | 3/8 |
| FX-BF**N | 4/0 AWG | 375 | 1 | 0.280 (7.1) | 1.380 (35.1) | 3.000 (76.2) | 1.750 (44.5) | 0.620 (15.7) | 0.560 (14.2) | 1/2 |
| FX-BG** | 300 kcmil | 510 | 1 | 0.364 (9.2) | 1.630 (41.4) | 2.500 (63.5) | 1.000 (25.4) | 0.750 (19.1) | 0.410 (10.4) | 3/8 |
| FX-BG**N | 300 kcmil | 510 | 1 | 0.364 (9.2) | 1.630 (41.4) | 3.000 (76.2) | 1.750 (44.5) | 0.620 (15.7) | 0.560 (14.2) | 1/2 |
| FX-B2D** | 154 kcmil | 380 | 2 | 0.210 (5.3) | 1.190 (30.2) | 2.500 (63.5) | 1.000 (25.4) | 0.750 (19.1) | 0.410 (10.4) | 3/8 |
| FX-B2D**N | 154 kcmil | 380 | 2 | 0.210 (5.3) | 1.190 (30.2) | 3.000 (76.2) | 1.750 (44.5) | 0.620 (15.7) | 0.560 (14.2) | 1/2 |
| FX-B2E** | 308 kcmil | 530 | 2 | 0.350 (8.9) | 1.250 (31.8) | 2.500 (63.5) | 1.000 (25.4) | 0.750 (19.1) | 0.410 (10.4) | 3/8 |
| FX-B2E**N | 308 kcmil | 530 | 2 | 0.350 (8.9) | 1.250 (31.8) | 3.000 (76.2) | 1.750 (44.5) | 0.620 (15.7) | 0.560 (14.2) | 1/2 |
| FX-B2F** | 464 kcmil | 600 | 2 | 0.380 (9.7) | 1.380 (35.1) | 2.500 (63.5) | 1.000 (25.4) | 0.750 (19.1) | 0.410 (10.4) | 3/8 |
| FX-B2F**N | 464 kcmil | 600 | 2 | 0.380 (9.7) | 1.380 (35.1) | 3.000 (76.2) | 1.750 (44.5) | 0.620 (15.7) | 0.560 (14.2) | 1/2 |
| FX-B2G** | 600 kcmil | 875 | 2 | 0.500 (12.7) | 1.630 (41.4) | 2.500 (63.5) | 1.000 (25.4) | 0.750 (19.1) | 0.410 (10.4) | 3/8 |
| FX-B2G**N | 600 kcmil | 875 | 2 | 0.500 (12.7) | 1.630 (41.4) | 3.000 (76.2) | 1.750 (44.5) | 0.620 (15.7) | 0.560 (14.2) | 1/2 |
| FX-B3D** | 231 kcmil | 470 | 3 | 0.270 (6.9) | 1.190 (30.2) | 2.500 (63.5) | 1.000 (25.4) | 0.750 (19.1) | 0.410 (10.4) | 3/8 |
| FX-B3D**N | 231 kcmil | 470 | 3 | 0.270 (6.9) | 1.190 (30.2) | 3.000 (76.2) | 1.750 (44.5) | 0.620 (15.7) | 0.560 (14.2) | 1/2 |
| FX-B3E** | 462 kcmil | 700 | 3 | 0.580 (14.7) | 1.250 (31.8) | 2.500 (63.5) | 1.000 (25.4) | 0.750 (19.1) | 0.410 (10.4) | 3/8 |
| FX-B3E**N | 462 kcmil | 700 | 3 | 0.580 (14.7) | 1.250 (31.8) | 3.000 (76.2) | 1.750 (44.5) | 0.620 (15.7) | 0.560 (14.2) | 1/2 |
| FX-B3F** | 696 kcmil | 900 | 3 | 0.590 (15.0) | 1.380 (35.1) | 2.500 (63.5) | 1.000 (25.4) | 0.750 (19.1) | 0.410 (10.4) | 3/8 |
| FX-B3F**N | 696 kcmil | 900 | 3 | 0.590 (15.0) | 1.380 (35.1) | 3.000 (76.2) | 1.750 (44.5) | 0.620 (15.7) | 0.560 (14.2) | 1/2 |
| FX-B3G** | 900 kcmil | 1000 | 3 | 0.690 (17.5) | 1.630 (41.4) | 2.500 (63.5) | 1.000 (25.4) | 0.750 (19.1) | 0.410 (10.4) | 3/8 |
| FX-B3G**N | 900 kcmil | 1000 | 3 | 0.690 (17.5) | 1.630 (41.4) | 3.000 (76.2) | 1.750 (44.5) | 0.620 (15.7) | 0.560 (14.2) | 1/2 |
| FX-B4D** | 308 kcmil | 600 | 4 | 0.390 (9.9) | 1.190 (30.2) | 2.500 (63.5) | 1.000 (25.4) | 0.750 (19.1) | 0.410 (10.4) | 3/8 |
| FX-B4D**N | 308 kcmil | 600 | 4 | 0.390 (9.9) | 1.190 (30.2) | 3.000 (76.2) | 1.750 (44.5) | 0.620 (15.7) | 0.560 (14.2) | 1/2 |
| FX-B4E** | 616 kcmil | 875 | 4 | 0.800 (20.3) | 1.250 (31.8) | 2.500 (63.5) | 1.000 (25.4) | 0.750 (19.1) | 0.410 (10.4) | 3/8 |
| FX-B4E**N | 616 kcmil | 875 | 4 | 0.800 (20.3) | 1.250 (31.8) | 3.000 (76.2) | 1.750 (44.5) | 0.620 (15.7) | 0.560 (14.2) | 1/2 |
| FX-B4F** | 928 kcmil | 1000 | 4 | 0.870 (22.1) | 1.380 (35.1) | 2.500 (63.5) | 1.000 (25.4) | 0.750 (19.1) | 0.410 (10.4) | 3/8 |
| FX-B4F**N | 928 kcmil | 1000 | 4 | 0.870 (22.1) | 1.380 (35.1) | 3.000 (76.2) | 1.750 (44.5) | 0.620 (15.7) | 0.560 (14.2) | 1/2 |
| FX-B4G** | 1200 kcmil | 1200 | 4 | 1.000 (25.4) | 1.630 (41.4) | 2.500 (63.5) | 1.000 (25.4) | 0.750 (19.1) | 0.410 (10.4) | 3/8 |
| FX-B4G**N | 1200 kcmil | 1200 | 4 | 1.000 (25.4) | 1.630 (41.4) | 3.000 (76.2) | 1.750 (44.5) | 0.620 (15.7) | 0.560 (14.2) | 1/2 |

Tested to UL 467, UL File E34440













Amp rating will vary with ambient conditions, orientation of the braid and other service conditions

** Available lengths (LL): 12 in, 18 in, 24 in, 36 in, 48 in

Contact Customer Care for custom lengths, mounting hole requirements and configurations

† Missing numerical value indicates single braid

Underground

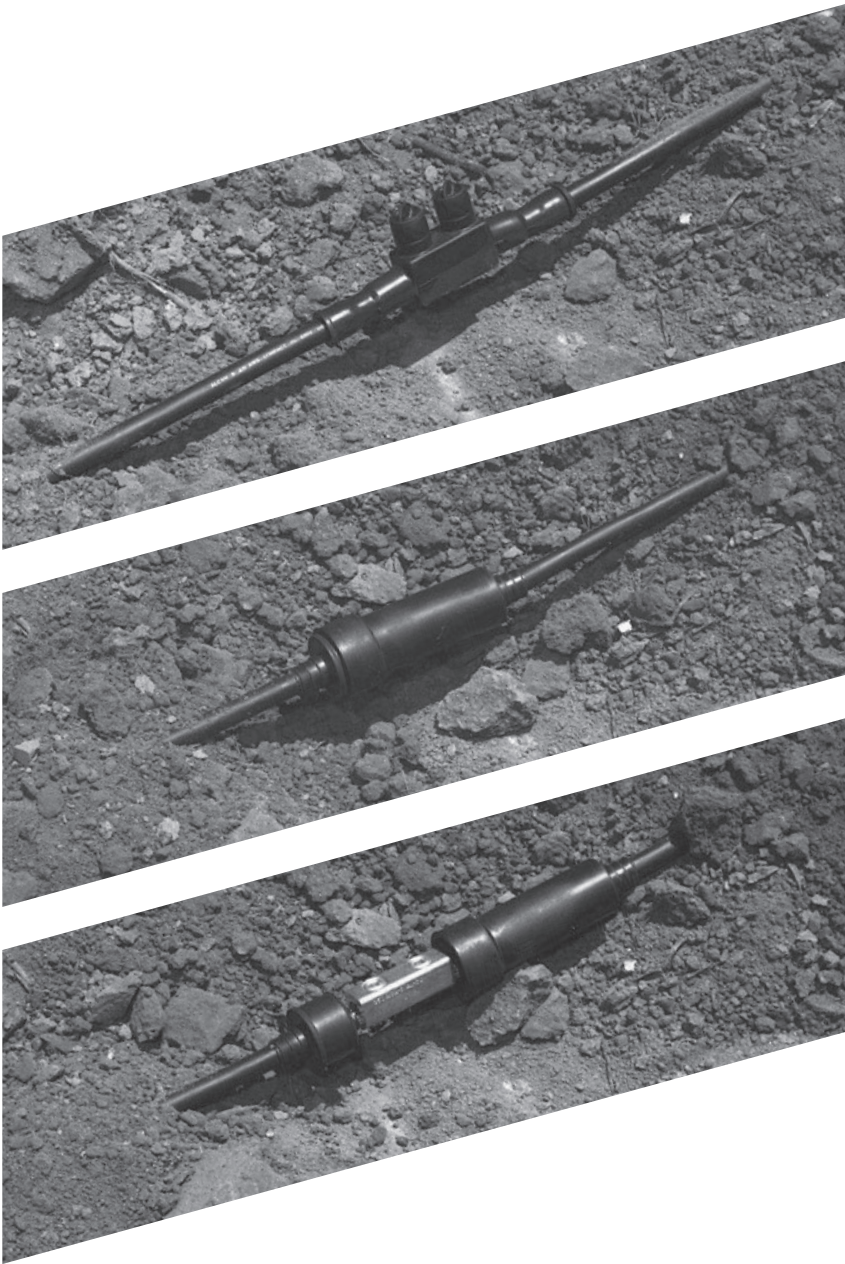
| | | | | | |
|----------------------------------------------------------------------------------------------------------------------|----------------------------------------------------------------------------------------------------------------|---------------------------------------------------------------------------------------------------------------------------|---------------------------------------------------------------------------------------------------------------------------|--------------------------------------------------------------------------------------------------------------------------|--------------------------------------------------------------------------------------------------------------------------------|
| <p>DBK</p>  <p>319</p> | <p>ASK</p>  <p>319</p> | <p>USPASS</p>  <p>320 - 321</p> | <p>SS, SSK, SSKC</p>  <p>322</p> | <p>PEDSS</p>  <p>323 - 324</p> | <p>STLSS, SLSS</p>  <p>325 - 327</p> |
| <p>GGB</p>  <p>328 - 329</p> | | <p>SLU-DB, XT-DB</p>  <p>330</p> | <p>RLT</p>  <p>331 - 332</p> | <p>SPS</p>  <p>333 - 334</p> | <p>SPD</p>  <p>335 - 336</p> |
| <p>TTGC</p>  <p>337</p> | |  | | | |

Direct Burial and Above Grade Splice Kits

RoHS
Compliant

UL
LISTED

SA

TYPE
DBK
ASK

Features

- DBK-1 connectors manufactured from electrolytic copper
- All other connectors manufactured from high strength aluminum alloy
- Heavy wall heat shrink tubing with sealant
- Connector and heat shrink packaged together
- Rated for 600 volts, 90° C/194° F

Benefits

- Provides maximum conductivity for UF cable
- Provides high conductivity and can be used with either aluminum or copper conductors
- Provides watertight splice. Kits with heat shrink are designed to withstand abrasions due to direct burial in rocky soil.
- Provides ease of ordering
- Ensures reliability



Fig. 1



Fig. 2



Fig. 3

| Catalog Number | Figure Number | UF Cable Range | | Wire Range | Testing Certification |
|----------------|---------------|------------------|-----------------|------------|-----------------------|
| | | Minimum | Maximum | | |
| DBK-1 | 1 | 14/2 with Ground | 8/3 with Ground | - | |
| DBK-2 | 2 | - | - | 2-8 | |
| DBK-250 | 2 | - | - | 250kcmil-1 | |

Tested UL 486D, UL File E125087

H

ABOVE GRADE SPLICE KITS

| Catalog Number | Figure Number | UF Cable Range | | Wire Range | Testing Certification |
|----------------|---------------|----------------|---------|------------|-----------------------|
| | | Minimum | Maximum | | |
| ASK-2* | 3 | - | - | 2-8 | |
| ASK-250* | 3 | - | - | 250kcmil-1 | |

All wire sizes, unless noted otherwise, are American Wire Gauge (AWG)

*Not UL Listed for direct burial.

Tested to UL 486A/B, UL File E125087

nVent ILSCO SafetySub

Watertight, Underground Connectors

RoHS
Compliant



TYPE USPASS

Features

- Encapsulated with dielectric strength polymer
- Manufactured from high strength aluminum alloy
- Compact design
- De-Ox oxide inhibiting compound optional
- Connector rated for 600 volts, 90° C/194° F
- Range taking
- Meets or exceeds UL 486D

Benefits

- Completely watertight in line splice. Ready for installation. (not a mold for use with mixed compounds) No taping required. No temperature or humidity restrictions.
- Suitable for use with copper or aluminum conductors
- Easily accessible in small hand holes
- Prevents oxides from forming
- Ensures reliability
- Reduces inventory
- UL Listed and CSA Certified for direct burial in earth or concrete

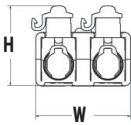
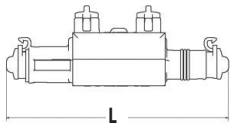

Fig. 1



Fig. 2



Fig. 3



Fig. 4

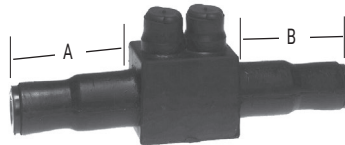

Fig. 5

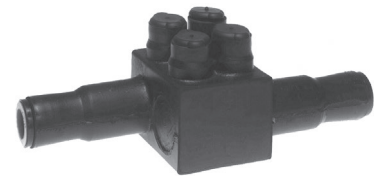

Fig. 6

| Catalog Number | Figure Number | Wire Range | Dimensions – in. (mm) | | |
|------------------|---------------|----------------|-----------------------|------------------|---------------|
| | | | Length – in. (mm) | Width – in. (mm) | L |
| USPA-1/0SS-DB* | 1 | 1/0-14 | 0.930 (23.6) | 1.925 (48.9) | 5.630 (143.0) |
| USPA21-1/0SS-DB* | 2 | 1/0-14 | 2.190 (55.6) | 1.925 (48.9) | 4.000 (101.6) |
| USPA22-1/0SS-DB* | 3 | 1/0-14 | 2.395 (60.8) | 2.000 (50.8) | 5.630 (143.0) |
| USPA-350SS-DB+ | 4 | 350kcmil-10str | 1.162 (29.5) | 2.500 (63.5) | 8.625 (219.0) |
| USPA-500SS-DB | 5 | 500kcmil-10 | 1.925 (48.8) | 3.219 (81.7) | 9.812 (249.2) |
| USPA-750SS-DB | 6 | 750kcmil-2 | 3.596 (91.3) | 3.843 (83.4) | 9.188 (233.4) |

All wire sizes, unless noted otherwise, are American Wire Gauge (AWG)

+ RUS Listed

Tested to UL 486D, UL File E125087

*For De-Ox, add "P" following the SS (e.g. USPA-1/0SSP-DB)



nVent ILSCO StreetWise Street Light Connectors



TYPE USPASS

Features

- Environmentally sealed design
- Encapsulated with high dielectric strength polymer
- Manufactured from high strength aluminum alloy
- Compact design
- Interchangeable wire and screw port plugs
- Cap retention hook
- Available in three circuit configurations
- Wire way seals with pre-marked trim locations
- De-Ox oxide inhibiting compound optional
- Rated for 600 volts
- Meets or exceeds UL 486D

Benefits

- Resists corrosion from moisture
- Touch safe, no taping required
- Suitable for use with copper or aluminum conductors
- Easily accessible in small hand holes
- Seals any entry port of the connector
- Tethered for re-insertion if required
- Application versatility
- Accommodates wire range 1/0-14
- Prevents oxides from forming
- For use in low voltage applications
- Watertight, suitable for direct burial

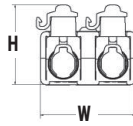
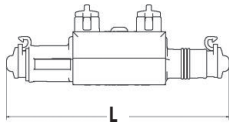

Fig. 1



Fig. 2



Fig. 3

| Catalog Number | Figure Number | Wire Range | Number of Ports | | Dimensions - in. (mm) | | |
|-----------------|---------------|------------|-----------------|---------|-----------------------|------------------|---------------|
| | | | Inputs | Outputs | Length - in. (mm) | Width - in. (mm) | L |
| USPA-1/0SS-DB | 1 | 1/0-14 | 1 | 1 | 0.930 (23.6) | 1.925 (48.9) | 5.630 (143.0) |
| USPA21-1/0SS-DB | 2 | 1/0-14 | 2 | 1 | 2.190 (55.6) | 1.925 (48.9) | 4.000 (101.6) |
| USPA22-1/0SS-DB | 3 | 1/0-14 | 2 | 2 | 2.395 (60.8) | 2.00 (50.8) | 5.630 (143.0) |

All wire sizes, unless noted otherwise, are American Wire Gauge (AWG)
Tested to UL File 486D
For De-Ox, add "P" following the SS (e.g. USPA-1/0SSP-DB)



Watertight Underground Splice Kits

TYPE
SS
SSK
SSKC

Features

- Watertight EPDM rubber splice cover
- Tapered ends
- Ready for installation
- Type SS is cover only supplied with lubricant
- Type SSK kit is supplied with both connector and lubricant
- Connector rated for 600 volts, 90° C/194° F

Benefits

- No taping required. Suitable for direct burial
- Fits a wide range of conductor sizes
- Not a mold, can be used in any type of weather. (moisture and humidity are not a factor)
- Can be used with standard aluminum or copper compression from 500kcmil - 6. Lubricant permits easy insertion of conductors into sleeve.
- Supplied with dual-rated mechanical splice connector with a wire range of 350kcmil - 6
- Ensures reliability

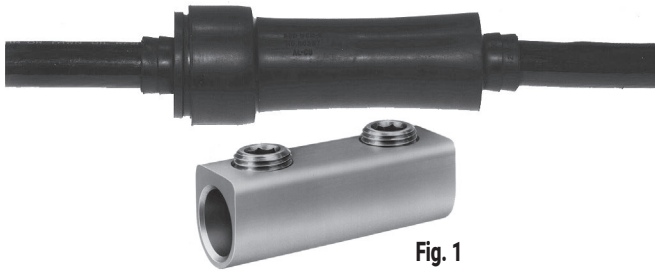
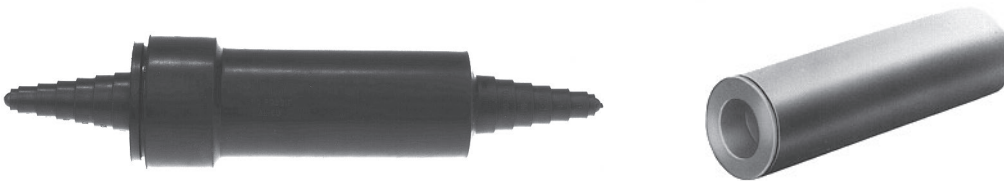

Fig. 1



Fig. 2

| Catalog Number | Figure Number | Dimensions (in.) | | |
|----------------|---------------|------------------|---------------------|-------|
| | | Bolted Connector | Compression Sleeves | L |
| SSK-350-Z | 1 | 350kcmil-6 | - | 5-1/2 |
| SS-350-Z | 2 | 350kcmil-6 | 500kcmil-6 | 5-1/2 |



H

| Catalog Number | Connector Catalog Number | Wire Size | Wire Range When Installed With IDT-12 Tool |
|----------------|--------------------------|-----------|--------------------------------------------|
| SSKC-6-Z | AS-6 | 6 | 6 |
| SSKC-4-Z | AS-4 | 4 | 4-6 |
| SSKC-2-Z | AS-2 | 2 | 2-6 |
| SSKC-1/0-Z | AS-1/0 | 1/0 | 1/0-1 |
| SSKC-2/0-Z | AS-2/0 | 2/0 | 2/0-1 |
| SSKC-3/0-Z | AS-3/0 | 3/0 | 3/0-1 |
| SSKC-4/0-Z | AS-4/0 | 4/0 | 4/0-1 |
| SSKC-250-Z | AS-250 | 250kcmil | 250kcmil-1/0 |

All wire sizes, unless noted otherwise, are American Wire Gauge (AWG)

SafetySub

Connector for Direct Burial and Hand Holes

Conductor Range: 500kcmil - #12str



TYPE PEDSS

Features

- Manufactured from high strength aluminum alloy
- Environmentally sealed design
- Dual rated
- Encapsulation meets or exceeds dielectric strength of 240 volts per mil (nominal thickness 125 mils)
- Re-sealable and tethered wire ports
- Pre-filled with De-Ox oxide inhibiting compound
- UL Listed and CSA Certified
- Rated for 600 volts, 90° C/194° F

Benefits

- Provides maximum conductivity
- Resist corrosion from moisture
- Use with both copper and aluminum conductors
- Specifically formulated for electrical waterproofing requirements
- Completely watertight, no taping required
- Protects contact area and prevents oxides from forming
- For direct burial in earth or concrete

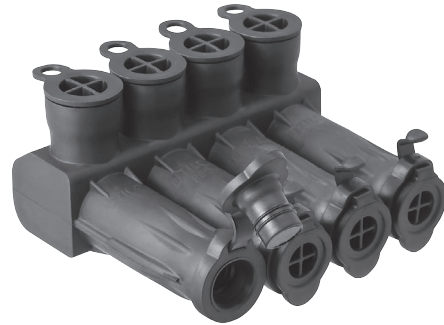
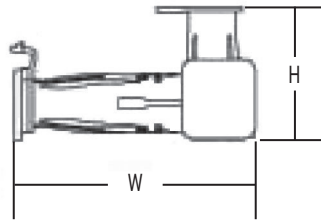
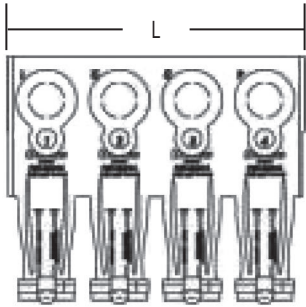

H

| Catalog Number | Wire Range | Number of Ports | Dimensions - in. (mm) | | |
|----------------|----------------|-----------------|-----------------------|--------------|----------------|
| | | | W | H | L |
| PED2-350SS-DB | 350kcmil-12str | 2 | 4.363 (110.8) | 2.375 (60.3) | 2.430 (61.7) |
| PED3-350SS-DB | 350kcmil-12str | 3 | 4.363 (110.8) | 2.375 (60.3) | 3.555 (90.3) |
| PED4-350SS-DB | 350kcmil-12str | 4 | 4.363 (110.8) | 2.375 (60.3) | 4.680 (118.9) |
| PED5-350SS-DB | 350kcmil-12str | 5 | 4.363 (110.8) | 2.375 (60.3) | 5.805 (147.4) |
| PED6-350SS-DB | 350kcmil-12str | 6 | 4.363 (110.8) | 2.375 (60.3) | 6.930 (176.0) |
| PED8-350SS-DB | 350kcmil-12str | 8 | 4.363 (110.8) | 2.375 (60.3) | 9.180 (233.2) |
| PED9-350SS-DB | 350kcmil-12str | 9 | 4.36 (110.8) | 2.375 (60.3) | 10.305 (261.7) |
| PED10-350SS-DB | 350kcmil-12str | 10 | 4.363 (110.8) | 2.375 (60.3) | 11.430 (290.3) |
| PED3-500SS-DB | 500kcmil-12str | 3 | 4.925 (125.1) | 2.700 (68.6) | 4.502 (114.4) |
| PED4-500SS-DB | 500kcmil-12str | 4 | 4.925 (125.1) | 2.700 (68.6) | 5.971 (151.7) |
| PED5-500SS-DB | 500kcmil-12str | 5 | 4.925 (125.1) | 2.700 (68.6) | 7.440 (189.0) |
| PED6-500SS-DB | 500kcmil-12str | 6 | 4.925 (125.1) | 2.700 (68.6) | 8.909 (226.3) |
| PED8-500SS-DB | 500kcmil-12str | 8 | 4.925 (125.1) | 2.700 (68.6) | 11.847 (300.9) |

All wire sizes, unless noted otherwise, are American Wire Gauge (AWG)
Tested to UL 486D, UL File E125087

Connector for Direct Burial and Hand Holes

and Hand Holes

Conductor Range: 750kcmil - #10

TYPE

PEDSS

Rated for 600

Features

- Manufactured from high strength aluminum alloy
- Clear plated
- Dual rated
- Encapsulation meets or exceeds dielectric strength of 240 volts per mil (nominal thickness 125 mils)
- Rated for 600 volts
- For direct burial in earth and concrete

Benefits

- Provides maximum conductivity
- Low contact resistance
- Use with both copper and aluminum conductors
- Specifically formulated for electrical waterproofing requirements

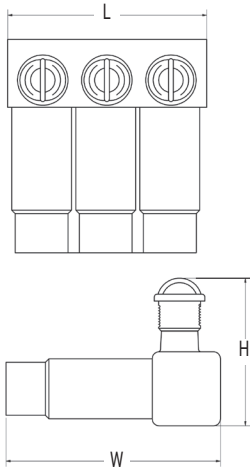
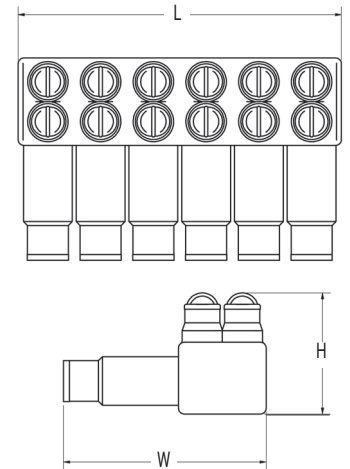

Fig. 1



Fig. 2



| Catalog Number | Figure Number | Wire Range | Number of Ports | Dimensions - in. (mm) | | |
|----------------|---------------|-------------|-----------------|-----------------------|--------------|----------------|
| | | | | W | H | L |
| PED-3-500-SS-Z | 1 | 500kcmil-10 | 3 | 5.060 (128.5) | 2.850 (72.4) | 4.314 (109.6) |
| PED-4-500-SS-Z | 1 | 500kcmil-10 | 4 | 5.060 (128.5) | 2.850 (72.4) | 5.782 (146.9) |
| PED-5-500-SS-Z | 1 | 500kcmil-10 | 5 | 5.060 (128.5) | 2.850 (72.4) | 7.250 (184.2) |
| PED-6-500-SS-Z | 1 | 500kcmil-10 | 6 | 5.060 (128.5) | 2.850 (72.4) | 8.719 (221.5) |
| PED-8-500-SS-Z | 1 | 500kcmil-10 | 8 | 5.060 (128.5) | 2.850 (72.4) | 11.657 (296.1) |
| PED-4-750-SS-Z | 2 | 750kcmil-2 | 4 | 6.502 (165.1) | 3.898 (99.1) | 6.973 (177.7) |
| PED-6-750-SS-Z | 2 | 750kcmil-2 | 6 | 6.502 (165.1) | 3.898 (99.1) | 10.351 (262.9) |
| PED-8-750-SS-Z | 2 | 750kcmil-2 | 8 | 6.502 (165.1) | 3.898 (99.1) | 13.729 (348.7) |



All wire sizes, unless noted otherwise, are American Wire Gauge (AWG)
Extra screw closure caps and extra conductor plugs available.

StreetWise

Street Light Connectors - UL Listed



TYPE STLSS

Features

- Environmentally sealed design
- Encapsulated with high dielectric strength polymer
- Manufactured from high strength aluminum alloy
- Precision engineered separation joint
- Fuse capable
- Compact design
- Interchangeable wire and screw port plugs
- Cap retention hook
- Available in four circuit configurations
- Wire way seals with pre-marked trim locations
- De-Ox oxide inhibiting compound optional
- Rated for 600 volts
- Meets or exceeds UL 486D

Benefits

- Resists corrosion from moisture
- Touch safe, no taping required
- Suitable for use with copper or aluminum conductors
- Safe breakaway on impact, theft deterrent
- Overcurrent protection
- Easily accessible in small hand holes
- Seals any entry port of the connector
- Tethered for re-insertion if required
- Application versatility
- Accommodates wire range 1/0-14
- Prevents oxides from forming
- For use in low voltage applications
- Watertight, suitable for direct burial

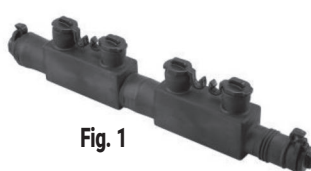
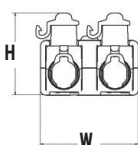
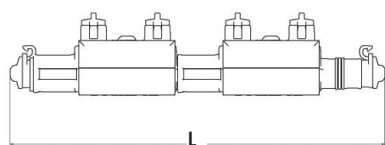

Fig. 1



Fig. 3



Fig. 2

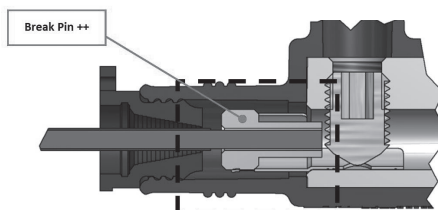
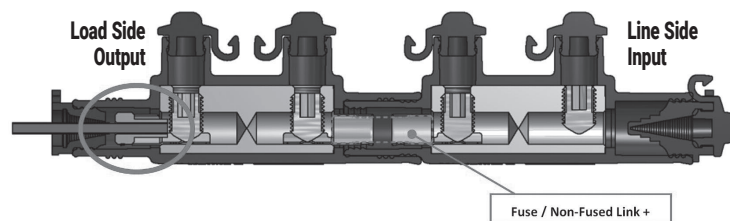

Fig. 4

| Catalog Number | Figure Number | Load Side Wire Range | Line Side Wire Range | Number of Ports | | Dimensions - in. (mm) | | |
|----------------|---------------|----------------------|----------------------|-----------------|---------|-----------------------|--------------|---------------|
| | | | | Inputs | Outputs | W | H | L |
| STL11-1/OSS6 | 1 | 6 | 1/0-14 | 1 | 1 | 0.930 (23.6) | 1.925 (48.9) | 9.130 (231.9) |
| STL12-1/OSS6 | 2 | 6 | 1/0-14 | 1 | 2 | 2.395 (60.8) | 1.995 (50.7) | 7.510 (190.8) |
| STL21-1/OSS6 | 3 | 6 | 1/0-14 | 2 | 1 | 2.190 (55.6) | 1.925 (48.9) | 7.525 (191.1) |
| STL22-1/OSS6 | 4 | 6 | 1/0-14 | 2 | 2 | 2.395 (60.8) | 1.995 (50.7) | 9.130 (231.9) |
| STL11-1/OSS8 | 1 | 8 | 1/0-14 | 1 | 1 | 0.930 (23.6) | 1.925 (48.9) | 9.130 (231.9) |
| STL12-1/OSS8 | 2 | 8 | 1/0-14 | 1 | 2 | 2.395 (60.8) | 1.995 (50.7) | 7.510 (190.8) |
| STL21-1/OSS8 | 3 | 8 | 1/0-14 | 2 | 1 | 2.190 (55.6) | 1.925 (48.9) | 7.525 (191.1) |
| STL22-1/OSS8 | 4 | 8 | 1/0-14 | 2 | 2 | 2.395 (60.8) | 1.995 (50.7) | 9.130 (231.9) |
| STL11-1/OSS10 | 1 | 10-14 | 1/0-14 | 1 | 1 | 0.930 (23.6) | 1.925 (48.9) | 9.130 (231.9) |
| STL12-1/OSS10 | 2 | 10-14 | 1/0-14 | 1 | 2 | 2.395 (60.8) | 1.995 (50.7) | 7.510 (190.8) |
| STL21-1/OSS10 | 3 | 10-14 | 1/0-14 | 2 | 1 | 2.190 (55.6) | 1.925 (48.9) | 7.525 (191.1) |
| STL22-1/OSS10 | 4 | 10-14 | 1/0-14 | 2 | 2 | 2.395 (60.8) | 1.995 (50.7) | 9.130 (231.9) |

H

All wire sizes, unless noted otherwise, are American Wire Gauge (AWG)
 Tested to UL File 486D
 For De-Ox, add "P" to end of catalog number
 Fuse must be supplied by customer
 ++ Break pins are supplied with the connector. Also available as Service parts, see below:



| ++ Break Pin | |
|----------------|-----|
| Catalog Number | QTY |
| BP6 | 3 |
| BP8 | 3 |
| BP10 | 3 |

| + Optional Non-fused Link | |
|---------------------------|-----|
| Catalog Number | QTY |
| NFL3 | 3 |
| NFL6 | 6 |
| NFL24 | 24 |

StreetWise

Street Light Connectors - Non-Fused

RoHS
Compliant

UL
LISTED
E479772
SPECIAL PURPOSE
CONNECTOR

SA
LR-2960

TYPE STLSS

Features

- Environmentally sealed design
- Encapsulated with high dielectric strength polymer
- Manufactured from high strength aluminum alloy
- Compact design
- Interchangeable wire and screw port plugs
- Cap retention hook
- Available in four circuit configurations
- Wire way seals with pre-marked trim locations
- De-Ox oxide inhibiting compound optional
- Rated for 600 volts
- Watertight

Benefits

- Resists corrosion from moisture
- Touch safe, no taping required
- Suitable for use with copper or aluminum conductors
- Break away feature for non-fused applications, easily accessible in small hand holes
- Seals any entry port of the connector
- Tethered for re-insertion if required
- Application versatility
- Accommodates wire range 1/0-14
- Prevents oxides from forming
- For use in low voltage applications
- Suitable for direct burial

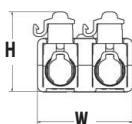
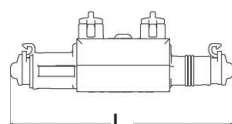

Fig. 1



Fig. 3



Fig. 2



Fig. 4

| Catalog Number | Figure Number | Load Side Wire Range | Line Side Wire Range | Number of Ports | | Dimensions - in. (mm) | | |
|----------------|---------------|----------------------|----------------------|-----------------|---------|-----------------------|--------------|---------------|
| | | | | Inputs | Outputs | W | H | L |
| STL11-1/OSS6 | 1 | 6 | 1/0-14 | 1 | 1 | 0.930 (23.6) | 1.925 (48.9) | 9.130 (231.9) |
| STL12-1/OSS6 | 2 | 6 | 1/0-14 | 1 | 2 | 2.395 (60.8) | 1.995 (50.7) | 7.510 (190.8) |
| STL21-1/OSS6 | 3 | 6 | 1/0-14 | 2 | 1 | 2.190 (55.6) | 1.925 (48.9) | 7.525 (191.1) |
| STL22-1/OSS6 | 4 | 6 | 1/0-14 | 2 | 2 | 2.395 (60.8) | 1.995 (50.7) | 9.130 (231.9) |
| STL11-1/OSS8 | 1 | 8 | 1/0-14 | 1 | 1 | 0.930 (23.6) | 1.925 (48.9) | 9.130 (231.9) |
| STL12-1/OSS8 | 2 | 8 | 1/0-14 | 1 | 2 | 2.395 (60.8) | 1.995 (50.7) | 7.510 (190.8) |
| STL21-1/OSS8 | 3 | 8 | 1/0-14 | 2 | 1 | 2.190 (55.6) | 1.925 (48.9) | 7.525 (191.1) |
| STL22-1/OSS8 | 4 | 8 | 1/0-14 | 2 | 2 | 2.395 (60.8) | 1.995 (50.7) | 9.130 (231.9) |
| STL11-1/OSS10 | 1 | 10-14 | 1/0-14 | 1 | 1 | 0.930 (23.6) | 1.925 (48.9) | 9.130 (231.9) |
| STL12-1/OSS10 | 2 | 10-14 | 1/0-14 | 1 | 2 | 2.395 (60.8) | 1.995 (50.7) | 7.510 (190.8) |
| STL21-1/OSS10 | 3 | 10-14 | 1/0-14 | 2 | 1 | 2.190 (55.6) | 1.925 (48.9) | 7.525 (191.1) |
| STL22-1/OSS10 | 4 | 10-14 | 1/0-14 | 2 | 2 | 2.395 (60.8) | 1.995 (50.7) | 9.130 (231.9) |



All wire sizes, unless noted otherwise, are American Wire Gauge (AWG)
 Tested to UL ECIS, special purpose connectors
 ++ Break pins are supplied with the connector. Also available as service parts, see below:

| ++ Break Pin | |
|----------------|-----|
| Catalog Number | QTY |
| BP6 | 3 |
| BP8 | 3 |
| BP10 | 3 |

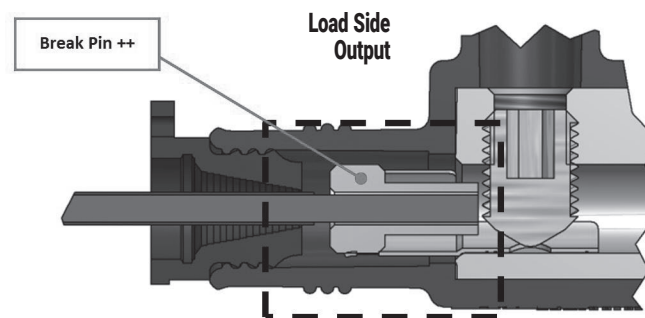

TYPE SLSS

Features

- Environmentally sealed design
- Encapsulated with high dielectric strength polymer
- Manufactured from high strength aluminum alloy
- Precision engineered separation joint
- Fuse capable
- Compact design
- Interchangeable wire and screw port plugs
- Cap retention hook
- Available in four circuit configurations
- Wire way seals with pre-marked trim locations
- De-Ox oxide inhibiting compound optional
- Rated for 600 volts
- Meets or exceeds ANSI C119.1 and C119.4 Class A specifications

Benefits

- Resists corrosion from moisture
- Touch safe, no taping required
- Suitable for use with copper or aluminum conductors
- Safe breakaway on impact, theft deterrent
- Overcurrent protection
- Easily accessible in small hand holes
- Seals any entry port of the connector
- Wire port caps tethered for reinsertion if required
- Application versatility
- Accommodates wire range 1/0-14
- Prevents oxides from forming
- For use in low voltage utility applications
- Watertight, suitable for direct burial

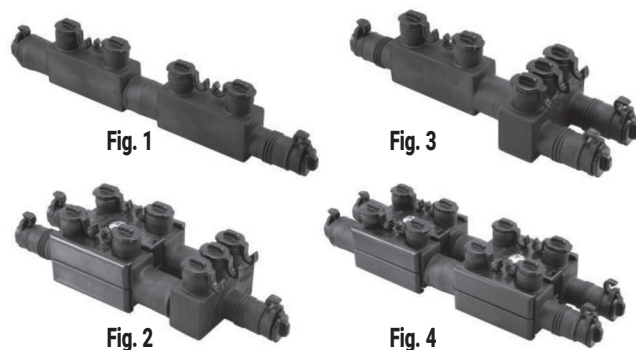
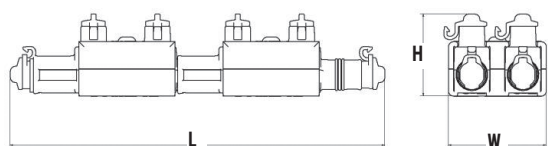

| Catalog Number | Figure Number | Wire Range | Number of Ports | | Dimensions - in. (mm) | | |
|----------------|---------------|------------|-----------------|---------|-----------------------|--------------|---------------|
| | | | Inputs | Outputs | W | H | L |
| STL11-1/0SS6 | 1 | 1/0-14 | 1 | 1 | 0.930 (23.6) | 1.925 (48.9) | 9.130 (231.9) |
| STL12-1/0SS6 | 2 | 1/0-14 | 1 | 2 | 2.395 (60.8) | 1.995 (50.7) | 7.510 (190.8) |
| STL21-1/0SS6 | 3 | 1/0-14 | 2 | 1 | 2.190 (55.6) | 1.925 (48.9) | 7.525 (191.1) |
| STL22-1/0SS10 | 4 | 1/0-14 | 2 | 2 | 2.395 (60.8) | 1.995 (50.7) | 9.130 (231.9) |

H

All wire sizes, unless noted otherwise, are American Wire Gauge (AWG)
Fuse must be supplied by customer

+ Optional Non-fused Link

| Catalog Number | QTY |
|----------------|-----|
| NFL3 | 3 |
| NFL6 | 6 |
| NFL24 | 24 |

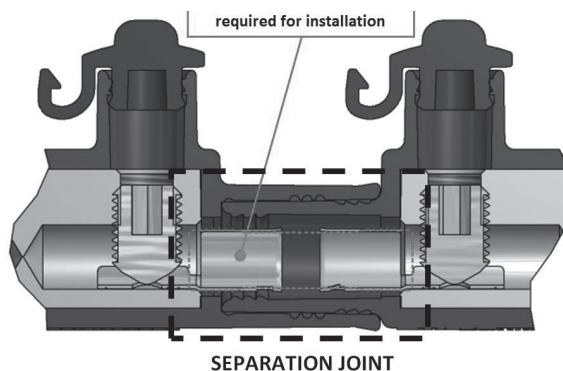
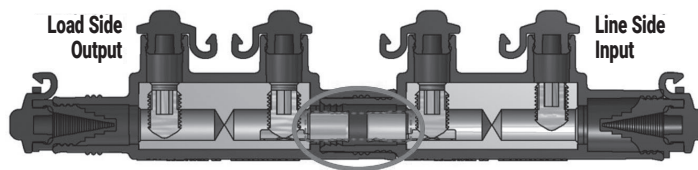

SLSS Option:
P - Inhibitor Applied

Example:
SLSS11-1/0SSP-Z
↑
Inhibitor must be Last

Compression Grounding

Figure 6 - 8 Grounding Grid



TYPE GGB

Features

- Manufactured from high strength copper alloy
- Clearly marked with wire size and die index
- Each size accepts a wide range of cable sizes
- Side 1 & Side 2 can be rotated to any position before crimping
- UL Listed and CSA Certified for grounding and bonding
- Prefilled with De-Ox oxide inhibiting compound
- TN in catalog number designates tin plated

Benefits

- Provides maximum conductivity
- Provides easy identification and tooling recommendation
- Application flexibility and reduced inventory
- Ease of installation
- Direct burial in earth or concrete
- Prevents oxides from forming
- For use with galvanized steel ground rod

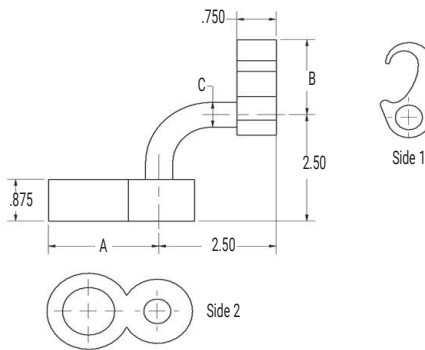

| Catalog Number | Commercial Copper Cable Range Side 1 | Metric Copper Cable Range Side 1 | Copper Weld Cable Range Side 1 | Ground Rod Dia. Side 2 | Rebar Side 2 | Dimensions - in. (mm) | | |
|----------------|------------------------------------------------|--------------------------------------------------------------------------|----------------------------------------------------|------------------------|--------------|-----------------------|--------------|-------------|
| | | | | | | A | B | C |
| GGB-5 | 500kcmil (.813 dia.) thru 250kcmil (.575 dia.) | 240mm ² (20.35mm dia.) thru 120mm ² (14.40mm dia.) | 498.8kcmil (.810 dia.) thru 248.8kcmil (.572 dia.) | 1/2 in | #3 | 1.390 (35.3) | 2.075 (52.7) | 0.312 (7.9) |
| GGB-6 | 500kcmil (.813 dia.) thru 250kcmil (.575 dia.) | 240mm ² (20.35mm dia.) thru 120mm ² (14.40mm dia.) | 498.8kcmil (.810 dia.) thru 248.8kcmil (.572 dia.) | 5/8 in | #4 | 1.455 (37.0) | 2.075 (52.7) | 0.312 (7.9) |
| GGB-6TN | 500kcmil (.813 dia.) thru 250kcmil (.575 dia.) | 240mm ² (20.35mm dia.) thru 20mm ² (14.40mm dia.) | 498.8kcmil (.810 dia.) thru 248.8kcmil (.572 dia.) | 5/8 in | N/A | 1.455 (37.0) | 2.075 (52.7) | 0.312 (7.9) |



All wire sizes, unless noted otherwise, are American Wire Gauge (AWG)
Tested to UL467, UL File E34440

Notes:

1. When used with ground rods, it is recommended to rough up the end of ground rod where GGB is to be placed. This provides good rotational resistance. **Perform a "pre-crimp" on ground rod prior to installing GGB connector. Use an indent type of die such as ILD-Precrimp.**

INFORMATION SHEET GGB SERIES

Grounding and Bonding Equipment
 Compression Connectors for Copper Conductors
 Suitable for Direct Burial In Earth or Concrete



LR-5465



| Catalog Number | Side A | | Side B | | Installation Tools | | | | | | | |
|----------------|--------------------|------------|----------------------------------|-----------------------|---------------------------|--------------------------------|-------|--------------------------------|--------------------------------------------------------------------|------------------------------------------------------------------|---------|---------|
| | Cu Ground Rod Size | Rebar Size | Galvanized Steel Ground Rod Size | Copper Wire Size | ILSCO Die Index (# Cimps) | UTILCO | Rigid | Greenlee Die Index (# Cimps) | Thomas & Betts Die Index (# Cimps) | Burdly Die Index (# Cimps) | | |
| GGB-1 | 1/2" | #3 | - | 2 - 250 kcmil | 998 (1) | UM-U42, UR-U42, BLL-U42 Series | | EK1240, HK1240, RK1240, RK1550 | 13100A, TBM14 Series, TBM15 Series, BPL T14 Series, BPL T15 Series | Y45 Series, Y46 Series, PAT46 Series, Y750 Series, PAT750 Series | 998 (1) | 997 (1) |
| GGB-2 | 5/8" | #4 | - | 2 - 250 kcmil | 998 (1) | | | | | 998 (1) | 997 (1) | |
| GGB-3 | 3/4" | #5 | - | 2 - 250 kcmil | 998 (1) | | | | | 998 (1) | 997 (1) | |
| GGB-3TN | - | - | 3/4" | 2 - 250 kcmil | 998 (1) | | | | | 998 (1) | 997 (1) | |
| GGB-4 | 1" | #6 - 7 | - | 2 - 250 kcmil | 998 (1) | | | | | N/A | 997 (1) | |
| GGB-5 | 1/2" | #3 | - | 250 kcmil - 500 kcmil | 998 (1) | | | | | 998 (1) | N/A | |
| GGB-6 | 5/8" | #4 | - | 250 kcmil - 500 kcmil | 998 (1) | | | | | 998 (1) | N/A | |
| GGB-6TN | - | - | 5/8" | 250 kcmil - 500 kcmil | 998 (1) | | | | | 998 (1) | N/A | |
| GGB-7 | 3/4" | #5 | - | 250 kcmil - 500 kcmil | 998 (1) | | | | | 998 (1) | N/A | |
| GGB-8 | 1" | #6 - 7 | - | 250 kcmil - 500 kcmil | 998 (1) | | | | | N/A | N/A | |

GGB Series compression ground grid cross connector can be used to connect a copper ground grid system together or to connect a copper ground grid system to a copper clad ground rod. They allow adjustment of each side of the connector prior to installation. They are pre-filled with inhibiting compound and are suitable for direct burial.

Notes:

1. Either ILSCO or Burdly Type U and P Dies can be used to install this product.
2. ILSCO and Burndy Type U-dies are designed to be used in crimping tools that apply at least 12-tons of pressure. Crimping ILSCO connectors with U-type dies in tools with less than 12-tons of pressure results in connections that do not meet ILSCO's design requirements for the system. Tools with less than 12-tons of pressure should not be used with U-type dies.
3. Adapter is required when using ILSCO LLC-15, Greenlee RK1550, Thomas & Betts TBM15, BPL T15, Burndy Y45, Y46 or PAT46 crimp tools.
4. When used with ground rod/rebar, it is recommended to rough up the end of ground rod/rebar where GGB is to be placed. This provides good rotational resistance. Perform a "pre-crimp" on ground rod/rebar prior to installing GGB connector. Use an indent type of die such as ILSCO's LD-PRECRIMP, Burndy's U2CABT (Die Index # 348) or UPRECRIMP-12, -58, -34.*
5. Each side of the GGB Series may be rotated around the ground rod/rebar to any desired position before crimping.
6. GGB -TN Series are specifically designed to be used to with Galvanized Steel Ground Rod.

* "U2CABT" and "UPRECRIMP" are registered trademarks TM of Burndy/FCL.

Direct Burial Copper Mechanical Lugs

RoHS
Compliant



TYPE SLU

Features

- Manufactured from electrolytic copper tubing and strip stock
- Compact design
- Range taking
- Re-usable
- UL Listed
- V-bottom collar

Benefits

- Provides maximum conductivity and strength
- Saves space and reduces installation time
- Permits inventories to be kept to a minimum
- Provides efficient use and flexibility in the field
- Suitable for direct burial in earth or concrete
- Wires are wedged between arched pressure bar and collar establishing positive contact and firm permanent grip

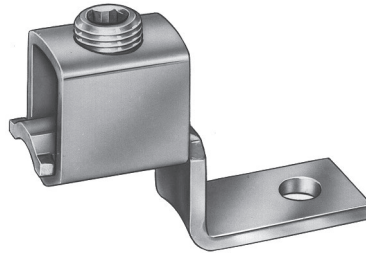
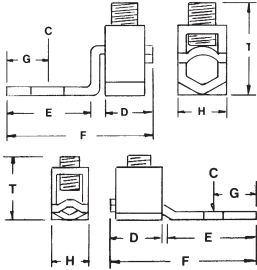

| Catalog Number | Wire Range Copper | Bolt Size | Dimensions (in.) | | | | | | | Hex Size |
|----------------|-----------------------|-----------|------------------|------|-------|---------|------|-----|-----|----------|
| | | | C | D | E | F | G | H | T | |
| SLU-35DB | 6-14 & List Comb. (A) | #10 | 13/64 | 7/16 | 15/32 | 1-3/16 | 7/32 | 3/8 | 3/4 | Slot |
| SLU-70DB | 2-8 & List Comb. (B) | 1/4 | 17/64 | 1/2 | 21/32 | 1-17/32 | 1/4 | 1/2 | 1 | Slot |

All wire sizes, unless noted otherwise, are American Wire Gauge (AWG)

(A) UL Listed wire combinations: (2) 14; (2) 12; (2) 10; (2) 8 and (4) 16

(B) UL Listed wire combinations: (2) 6 and (2) 8

Tested to UL 467, UL File E34440

TYPE XT

Features

- Manufactured from electrolytic copper tubing and strip stock
- Compact design
- Range taking
- Re-usable
- UL Listed

Benefits

- Provides maximum conductivity and strength
- Saves space and reduces installation time.
- Permits inventories to be kept to a minimum
- Provides efficient use and flexibility in the field
- Suitable for direct burial in earth or concrete



H

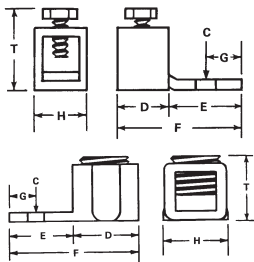

| Catalog Number | Wire Range Copper | Bolt Size | Dimensions (in.) | | | | | | | Hex Size |
|----------------|-----------------------|-----------|------------------|-----|-------|-------|------|-----|-----|----------|
| | | | C | D | E | F | G | H | T | |
| XT-6DB | 6-14 | #10 | 13/64 | 3/8 | 17/32 | 1 | 7/32 | 3/8 | 3/4 | Slot |
| XT-4DB | 4-14 & List Comb. (A) | 1/4 | 17/64 | 1/2 | 5/8 | 1-1/8 | 1/4 | 1/2 | 5/8 | Slot |

All wire sizes, unless noted otherwise, are American Wire Gauge (AWG)

(A) UL Listed wire combinations: (2) 14; (2) 12; (2) 10; (2) 8 and (4) 16

Tested to UL 467, UL File E34440

Grounding Connectors

For Copper Conductor Only



TYPE RLT

Features

- UL Listed and CSA certified for direct burial in earth or concrete
- Range taking
- Manufactured from high strength copper alloy
- Prefilled with De-Ox oxide inhibitor compound and bagged
- Clearly marked with wire size and die index

Benefits

- Ensures reliability
- Reduces inventory
- Provides maximum conductivity and eliminates the possibility of corrosion
- Prevents oxides from forming
- Provides easy identification and tooling recommendations

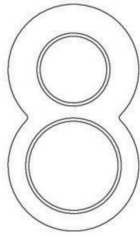
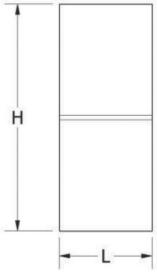

Fig. 1



Fig. 2



Fig. 3

| Catalog Number | Figure Number | Ground Rod Size | Wire Range | Die Index | Dimensions - in. (mm) | |
|----------------|---------------|-----------------|---------------------|-----------|-----------------------|--------------|
| | | | | | H | L |
| RLT-10 | 1 | 1 | 2/0 - 2 | 998/1011 | 2.440 (62.0) | 0.880 (22.4) |
| RLT-12 | 1 | 1 | 500kcmil - 300kcmil | 998/1011 | 2.680 (68.1) | 0.880 (22.4) |
| RLT-8TN* | 3 | 5/8 | 500kcmil - 300kcmil | 998/1011 | 2.142 (54.4) | 0.875 (22.2) |
| RLT-9TN* | 3 | 3/4 | 500kcmil - 300kcmil | 998/1011 | 2.432 (61.8) | 0.875 (22.2) |



All wire sizes, unless noted otherwise, are American Wire Gauge (AWG)

Tested to UL 467, UL File E34440

* All suffix "TN" parts electro-tin plated; to be specifically used with galvanized steel ground rod. The ground rod hole diameter is larger to suit galvanized steel.

INFORMATION SHEET (RLT, RLT-TN SERIES)

Grounding and Bonding Equipment
 Compression Connectors for Copper Conductors
 Suitable for Direct Burial in Earth or Concrete



L# 2960*



| Catalog Number | Copper Ground Rod Size | Galv. Steel Ground Rod Size | Copper Wire Range | ILSCO | | | | | UTILCO | | Installation Tools | | | | | Burndy | | | |
|----------------|------------------------|-----------------------------|---------------------|--------------------|--------------------|---------------------|--------------------|---------------------|--------------------|--------------------|--------------------|---------------------|--------------------|---------------------|--------------------|---------------------|--------------------|---------------------|---|
| | | | | Die 998 (# Crimps) | Die 998 (# Crimps) | Die 1011 (# Crimps) | Die 998 (# Crimps) | Die 1011 (# Crimps) | Die 998 (# Crimps) | Die 998 (# Crimps) | Die 998 (# Crimps) | Die 1011 (# Crimps) | Die 998 (# Crimps) | Die 1011 (# Crimps) | Die 998 (# Crimps) | Die 1011 (# Crimps) | Die 998 (# Crimps) | Die 1011 (# Crimps) | |
| RLT-2 | 1/2 | - | #2 - 2/0 AWG | 1 | 1 | 2 | 1 | 2 | 1 | 1 | 1 | 1 | 1 | 1 | 1 | 1 | 1 | 1 | 1 |
| RLT-3 | 5/8 | - | #2 - 2/0 AWG | 1 | 1 | 2 | 1 | 2 | 1 | 1 | 1 | 1 | 1 | 1 | 1 | 1 | 1 | 1 | 1 |
| RLT-4 | 3/4 | - | #2 - 2/0 AWG | 1 | 1 | 2 | 1 | 2 | 1 | 1 | 1 | 1 | 1 | 1 | 1 | 1 | 1 | 1 | 1 |
| RLT-5 | 1/2 | - | 4/0 AWG - 250 kcmil | 1 | 1 | 2 | 1 | 2 | 1 | 1 | 1 | 1 | 1 | 1 | 1 | 1 | 1 | 1 | 1 |
| RLT-6 | 5/8 | - | 4/0 AWG - 250 kcmil | 1 | 1 | 2 | 1 | 2 | 1 | 1 | 1 | 1 | 1 | 1 | 1 | 1 | 1 | 1 | 1 |
| RLT-7 | 3/4 | - | 4/0 AWG - 250 kcmil | 1 | 1 | 2 | 1 | 2 | 1 | 1 | 1 | 1 | 1 | 1 | 1 | 1 | 1 | 1 | 1 |
| RLT-8 | 5/8 | - | 300 - 500 kcmil | 1 | 1 | 2 | 1 | 2 | 1 | 1 | 1 | 1 | 1 | 1 | 1 | 1 | 1 | 1 | 1 |
| RLT-9 | 3/4 | - | 300 - 500 kcmil | 1 | 1 | 2 | 1 | 2 | 1 | 1 | 1 | 1 | 1 | 1 | 1 | 1 | 1 | 1 | 1 |
| RLT-10 | 1 | - | #2 - 2/0 AWG | 1 | 1 | 2 | 1 | 2 | 1 | 1 | 1 | 1 | 1 | 1 | 1 | 1 | 1 | 1 | 1 |
| RLT-11 | 1 | - | 4/0 AWG - 250 kcmil | 1 | 1 | 2 | 1 | 2 | 1 | 1 | 1 | 1 | 1 | 1 | 1 | 1 | 1 | 1 | 1 |
| RLT-12 | 1 | - | 300 - 500 kcmil | 1 | 1 | 2 | 1 | 2 | 1 | 1 | 1 | 1 | 1 | 1 | 1 | 1 | 1 | 1 | 1 |
| RLT-13 | 5/8 | - | #2 AWG Sol | 1 | 1 | 2 | 1 | 2 | 1 | 1 | 1 | 1 | 1 | 1 | 1 | 1 | 1 | 1 | 1 |
| RLT-4TN | - | 3/4 | #2 - 2/0 AWG | 1 | 1 | 2 | 1 | 2 | 1 | 1 | 1 | 1 | 1 | 1 | 1 | 1 | 1 | 1 | 1 |
| RLT-7TN | - | 3/4 | 4/0 AWG - 250kcmil | 1 | 1 | 2 | 1 | 2 | 1 | 1 | 1 | 1 | 1 | 1 | 1 | 1 | 1 | 1 | 1 |
| RLT-8TN | - | 5/8 | 300 - 500 kcmil | 1 | 1 | 2 | 1 | 2 | 1 | 1 | 1 | 1 | 1 | 1 | 1 | 1 | 1 | 1 | 1 |
| RLT-9TN | - | 3/4 | 300 - 500 kcmil | 1 | 1 | 2 | 1 | 2 | 1 | 1 | 1 | 1 | 1 | 1 | 1 | 1 | 1 | 1 | 1 |

RLT Series of compression connectors are designed to connect a copper ground conductor to a copper clad ground rod.
 RLT-TN Series of compression connectors are designed to connect a copper ground conductor to a galvanized steel ground rod.
 Both RLT and RLT-TN Series of compression connectors are pre-filled with inhibiting compound and are suitable for direct burial.

Notes:

1. Either ILSCO or Burndy Type U and P Dies can be used to install this product.
2. ILSCO and Burndy Type U Dies are designed to be used in crimping tools that apply at least 12-tons of pressure. Crimping ILSCO connectors with U-type dies in tools with less than 12-tons of pressure results in connectors that do not meet ILSCO's design requirements for the system. Tools with less than 12-tons of pressure should not be used with U-type dies.
3. Adapter is required when using ILSCO ILC-15, Greenlee RK1550, Thomas & Betts TBM15, BPL T15, Burndy Y45, Y46 or PAT46 crimp tools.
4. It is recommended to rough up the end of the ground rod where the RLT or RLT-TN is to be placed. This provides good rotational resistance. Perform a "pre-crimp" on ground rod prior to installing RLT or RLT-TN connector. Use an indent type of die such as ILSCOs ILD-PRECRIMP, Burndy's UZCABT (Die Index # 348) or UPRECRIMP-12, -58, -34*.
5. Both RLT and RLT-TN Series may be rotated around the rod to any desired position before crimping.

* "UZCABT" and "UPRECRIMP" are registered trademarks TM of Burndy/FCI

Form 194

Revised 5-12-2020

Bronze, Service Post Connectors

Single Conductor Type - Short Stud, Male

RoHS
Compliant

UL
LISTED
8M24

SA
4P-100973-1

TYPE
SPS

Features

- Range taking
- Re-usable
- UL 486A/B and UL 467 Listed
- For grounding of steel structures, fence posts and tapping cables from bus bar
- For copper to copper connections

Benefits

- Permits inventories to be kept to a minimum
- Provides efficient use and flexibility in the field
- Ensures reliability
- Flexibility in the field

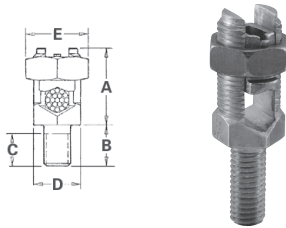

| Catalog Number | Conductor Range AWG MM ² | | | | Maximum Diameter Range | Stud Size | Dimensions (in.) | | | | |
|----------------|-------------------------------------|--------------------------|------------------------|------------------------|------------------------|----------------|------------------|-------|---------|--------|---------|
| | Stranded | | Solid | | | | A | B | C | D | E |
| | Max. | Min. | Max. | Min. | | | | | | | |
| SPSS-0 | 8 | 12 (4mm ²) | 8 (10mm ²) | 12 (4mm ²) | .146-.080 | 1/4-20 x 1/2 | 11/16 | 1/2 | 55/64 | 15/32 | 1/2 |
| SPSS-1 | 7 (10mm ²) | 10 (6mm ²) | 6 (10mm ²) | 10 (6mm ²) | .170-.102 | 1/4-20 x 1/2 | 13/16 | 1/2 | 55/64 | 15/32 | 21/32 |
| SPSS-2 | 5 (16mm ²) | 10 (6mm ²) | 4 (16mm ²) | 10 (6mm ²) | .217-.102 | 5/16-18 x 5/8 | 15/16 | 5/8 | 53/64 | 17/32 | 23/32 |
| SPSS-3 | 3 (25mm ²) | 10 (6mm ²) | 2 (35mm ²) | 10 (6mm ²) | .271-.102 | 3/8-16 x 5/8 | 1/2 | 5/8 | 61/64 | 5/8 | 25/32 |
| SPSS-4 | 1 (35mm ²) | 8 (6mm ²) | 2 (35mm ²) | 8 (10mm ²) | .332-.128 | 3/8-16 x 5/8 | 1-1/16 | 5/8 | 61/64 | 11/16 | 7/8 |
| SPSS-5 | 1/0 (50mm ²) | 2 (35mm ²) | 2 (35mm ²) | - | .385-.258 | 1/2-13 x 3/4 | 1-1/4 | 3/4 | 1-5/64 | 3/4 | 15/16 |
| SPSS-6 | 2/0 (70mm ²) | 2 (35mm ²) | 2 (35mm ²) | - | .443-.258 | 1/2-13 x 3/4 | 1-13/32 | 3/4 | 1-5/64 | 7/8 | 1-1/16 |
| SPSS-8 | 4/0 (95mm ²) | 1 (35mm ²) | - | - | .570-.289 | 5/8-11 x 1 | 1-9/16 | 1 | 1-19/64 | 1 | 1-5/16 |
| SPSS-9 | 350 (150mm ²) | 1/0 (70mm ²) | - | - | .715-.373 | 5/8-11 x 1 | 2 | 1-1/4 | 1-19/64 | 1-5/16 | 1-11/16 |
| SPSS-10 | 500 (240mm ²) | 3/0 (95mm ²) | - | - | .840-.464 | 3/4-10 x 1-1/4 | 2-1/4 | 1-3/4 | 1-31/64 | 1-1/2 | 1-7/8 |

All wire sizes, unless noted otherwise, are American Wire Gauge (AWG)
UL File E158587

H

Bronze, Service Post Connectors

Single Conductor Type - Long Stud, Male

RoHS
Compliant



TYPE SPS

Features

- Range taking
- Re-usable
- UL 486A/B and UL 467 Listed
- For grounding of steel structures, fence posts and tapping cables from bus bar
- For copper to copper connections

Benefits

- Permits inventories to be kept to a minimum
- Provides efficient use and flexibility in the field
- Ensures reliability
- Flexibility in the field

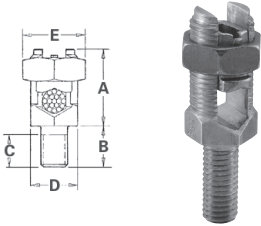

| Catalog Number | Conductor Range AWG MM ² | | | | Maximum Diameter Range | Stud Size | Dimensions (in.) | | | | |
|----------------|-------------------------------------|--------------------------|------------------------|------------------------|------------------------|----------------|------------------|-------|---------|-------|--------|
| | Stranded | | Solid | | | | A | B | C | D | E |
| | Max. | Min. | Max. | Min. | | | | | | | |
| SPSL-0 | 8 | 12 (4mm ²) | 8 (10mm ²) | 12 (4mm ²) | .146-.080 | 1/4-20 x 1 | 11/16 | 1 | 55/64 | 15/32 | 1/2 |
| SPSL-1 | 7 (10mm ²) | 10 (6mm ²) | 6 (10mm ²) | 10 (6mm ²) | .170-.102 | 1/4-20 x 1 | 13/16 | 1 | 55/64 | 15/32 | 21/32 |
| SPSL-2 | 5 (16mm ²) | 10 (6mm ²) | 4 (16mm ²) | 10 (6mm ²) | .217-.102 | 5/16-18 x 1 | 15/16 | 1 | 53/64 | 17/32 | 23/32 |
| SPSL-3 | 3 (25mm ²) | 10 (6mm ²) | 2 (35mm ²) | 10 (6mm ²) | .271-.102 | 3/8-16 x 1-1/8 | 1/2 | 1-1/8 | 61/64 | 5/8 | 25/32 |
| SPSL-4 | 1 (35mm ²) | 8 (6mm ²) | 2 (35mm ²) | 8 (10mm ²) | .332-.128 | 3/8-16 x 1-1/8 | 1-1/16 | 1-1/8 | 61/64 | 11/16 | 7/8 |
| SPSL-5 | 1/0 (50mm ²) | 2 (35mm ²) | 2 (35mm ²) | - | .385-.258 | 1/2-13 x 1-1/4 | 1-1/4 | 1-1/4 | 1-5/64 | 3/4 | 15/16 |
| SPSL-6 | 2/0 (70mm ²) | 2 (35mm ²) | 2 (35mm ²) | - | .443-.258 | 1/2-13 x 1-1/4 | 1-13/32 | 1-1/4 | 1-5/64 | 7/8 | 1-1/16 |
| SPSL-8 | 4/0 (95mm ²) | 1 (35mm ²) | - | - | .570-.289 | 5/8-11 x 1-1/2 | 1-9/16 | 1-1/2 | 1-19/64 | 1 | 1-5/16 |
| SPSL-10 | 500 (240mm ²) | 3/0 (95mm ²) | - | - | .840-.464 | 3/4-10 x 1-3/4 | 2-1/4 | 1-1/2 | 1-31/64 | 1-1/2 | 1-7/8 |

All wire sizes, unless noted otherwise, are American Wire Gauge (AWG)
UL File E158587



Bronze, Service Post Connectors

Double Conductor Type - Short Stud, Male

RoHS
Compliant



TYPE
SPD

Features

- Range taking
- Re-usable
- UL 486A/B and UL 467 Listed
- For grounding of steel structures, fence posts and tapping cables from bus bar
- For copper to copper connections

Benefits

- Permits inventories to be kept to a minimum
- Provides efficient use and flexibility in the field
- Ensures reliability
- Flexibility in the field

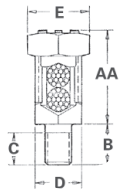

| Catalog Number | Conductor Range AWG MM ² | | | | Maximum Diameter Range | Stud Size | Dimensions (in.) | | | | |
|----------------|-------------------------------------|--------------------------|------------------------|------------------------|------------------------|----------------|------------------|-------|---------|-------|--------|
| | Stranded | | Solid | | | | A | B | C | D | E |
| | Max. | Min. | Max. | Min. | | | | | | | |
| SPDS-0 | 8 | 12 (4mm ²) | 8 (10mm ²) | 12 (4mm ²) | .146-.080 | 1/4-20 x 1/2 | 13/16 | 1/2 | 55/64 | 15/32 | 1/2 |
| SPDS-1 | 7 (10mm ²) | 10 (6mm ²) | 6 (10mm ²) | 10 (6mm ²) | .170-.102 | 1/4-20 x 1/2 | 31/32 | 1/2 | 55/64 | 15/32 | 21/32 |
| SPDS-2 | 5 (16mm ²) | 10 (6mm ²) | 4 (16mm ²) | 10 (6mm ²) | .217-.102 | 5/16-18 x 5/8 | 1-1/8 | 5/8 | 53/64 | 17/32 | 23/32 |
| SPDS-3 | 3 (25mm ²) | 10 (6mm ²) | 2 (35mm ²) | 10 (6mm ²) | .271-.102 | 3/8-16 x 5/8 | 1-1/4 | 5/8 | 61/64 | 5/8 | 25/32 |
| SPDS-4 | 1 (35mm ²) | 8 (6mm ²) | 2 (35mm ²) | 8 (10mm ²) | .332-.128 | 3/8-16 x 5/8 | 1-3/8 | 5/8 | 61/64 | 11/16 | 7/8 |
| SPDS-5 | 1/0 (50mm ²) | 2 (35mm ²) | 2 (35mm ²) | - | .385-.258 | 1/2-13 x 3/4 | 1-19/32 | 3/4 | 1-5/64 | 3/4 | 15/16 |
| SPDS-6 | 2/0 (70mm ²) | 2 (35mm ²) | 2 (35mm ²) | - | .443-.258 | 1/2-13 x 3/4 | 1-13/16 | 3/4 | 1-5/64 | 7/8 | 1-1/16 |
| SPDS-8 | 4/0 (95mm ²) | 1 (35mm ²) | - | - | .570-.289 | 5/8-11 x 1 | 2-1/16 | 1 | 1-19/64 | 1 | 1-5/16 |
| SPDS-10 | 500 (240mm ²) | 3/0 (95mm ²) | - | - | .840-.464 | 3/4-10 x 1-1/4 | 3-1/8 | 1-3/4 | 1-31/64 | 1-1/2 | 1-7/8 |

H

All wire sizes, unless noted otherwise, are American Wire Gauge (AWG)
UL File E158587

Bronze, Service Post Connectors

Double Conductor Type - Long Stud, Male



TYPE SPD

Features

- Range taking
- Re-usable
- UL 486A/B and UL 467 Listed
- For grounding of steel structures, fence posts and tapping cables from bus bar
- For copper to copper connections

Benefits

- Permits inventories to be kept to a minimum
- Provides efficient use and flexibility in the field
- Ensures reliability
- Flexibility in the field

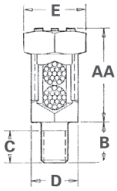

| Catalog Number | Conductor Range AWG MM ² | | | | Maximum Diameter Range | Stud Size | Dimensions (in.) | | | | |
|----------------|-------------------------------------|--------------------------|------------------------|------------------------|------------------------|----------------|------------------|-------|---------|--------|---------|
| | Stranded | | Solid | | | | A | B | C | D | E |
| | Max. | Min. | Max. | Min. | | | | | | | |
| SPDL-0 | 8 | 12 (4mm ²) | 8 (10mm ²) | 12 (4mm ²) | .146-.080 | 1/4-20 x 1 | 13/16 | 1 | 55/64 | 15/32 | 1/2 |
| SPDL-1 | 7 (10mm ²) | 10 (6mm ²) | 6 (10mm ²) | 10 (6mm ²) | .170-.102 | 1/4-20 x 1 | 31/32 | 1 | 55/64 | 15/32 | 21/32 |
| SPDL-2 | 5 (16mm ²) | 10 (6mm ²) | 4 (16mm ²) | 10 (6mm ²) | .217-.102 | 5/16-18 x 1 | 1-1/8 | 1 | 53/64 | 17/32 | 23/32 |
| SPDL-3 | 3 (25mm ²) | 10 (6mm ²) | 2 (35mm ²) | 10 (6mm ²) | .271-.102 | 3/8-16 x 1-1/8 | 1-1/4 | 1-1/8 | 61/64 | 5/8 | 25/32 |
| SPDL-4 | 1 (35mm ²) | 8 (6mm ²) | 2 (35mm ²) | 8 (10mm ²) | .332-.128 | 3/8-16 x 1-1/8 | 1-3/8 | 1-1/8 | 61/64 | 11/16 | 7/8 |
| SPDL-5 | 1/0 (50mm ²) | 2 (35mm ²) | 2 (35mm ²) | - | .385-.258 | 1/2-13 x 1-1/4 | 1-19/32 | 1-1/4 | 1-5/64 | 3/4 | 15/16 |
| SPDL-6 | 2/0 (70mm ²) | 2 (35mm ²) | 2 (35mm ²) | - | .443-.258 | 1/2-13 x 1-1/4 | 1-13/16 | 1-1/4 | 1-5/64 | 7/8 | 1-1/16 |
| SPDL-8 | 4/0 (95mm ²) | 1 (35mm ²) | - | - | .570-.289 | 5/8-11 x 1-1/2 | 2-1/16 | 1-1/2 | 1-19/64 | 1 | 1-5/16 |
| SPDL-9 | 350 (150mm ²) | 1/0 (70mm ²) | - | - | .715-.373 | 5/8-11 x 1-1/2 | 2-3/4 | 1-1/2 | 1-19/64 | 1-5/16 | 1-11/16 |
| SPDL-10 | 500 (240mm ²) | 3/0 (95mm ²) | - | - | .840-.464 | 3/4-10 x 1-3/4 | 3-1/8 | 1-1/2 | 1-31/64 | 1-1/2 | 1-7/8 |



All wire sizes, unless noted otherwise, are American Wire Gauge (AWG)

UL File E158587

Bronze, Transformer Tank Ground Connectors

RoHS
Compliant

TYPE TTGC

Features

- Manufactured from bronze
- Eye bolt on TTGC2 rotates to accommodate cable in vertical or horizontal direction
- Range taking
- Stud fits all standard EEI-NEMA distribution transformers

Benefits

- Provides maximum strength and superior conductivity
- Flexibility
- Permits inventories to be kept to a minimum
- Reliability

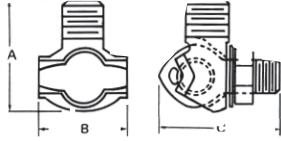

| Catalog Number | Conductor Range | | Stud Thread Size UNC - 2A | Dimensions (in.) | | |
|----------------|-----------------|--------|---------------------------|------------------|--------|---------|
| | Max. | Min. | | A | B | C |
| TTGC2 | 2/0 | 8 sol | 1/2-13 | 1-51/64 | 1-9/64 | 1-21/32 |
| TTGC3 | 1 str | 10 sol | 1/2-13 | 1-3/8 | 1-3/64 | 1-9/16 |
| TTGC4+ | 1 str | 10 sol | 1/2-13 | 1-1/4 | 7/8 | 1-3/8 |
| TTGC2TN+ | 2/0 | 8 sol | 1/2-13 | 1-51/64 | 1-9/64 | 1-21/32 |
| TTGC3TN* | 1 str | 10 sol | 1/2-13 | 1-3/8 | 1-3/64 | 1-9/16 |
| TTGC4TN* | 1 str | 10 sol | 1/2-13 | 1-1/4 | 7/8 | 1-3/8 |

All wire sizes, unless noted otherwise, are American Wire Gauge (AWG)

+ RUS Listed

* Tin Plated

H

Heat Shrinkable Products

SILICONE TAPE - SFT



339

HEAVY WALL

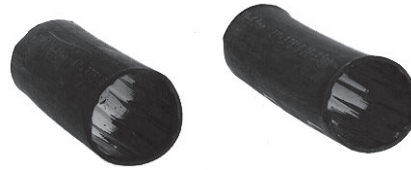

340

END CAPS

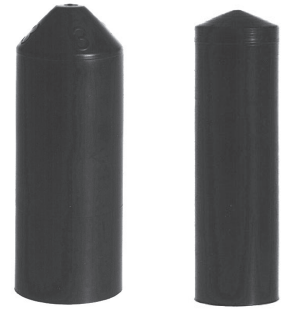

341

MEDIUM WALL



342

THIN WALL



343

BULK REELS



344

HEAT GUN



345

Silicone Tape Wrap 'N Seal

RoHS
Compliant

UL
LISTED
8M24

SF
AP.100913-1

TYPE
SFT

Features

- Self fusing
- 700 PSI tensile strength
- Insulates 8,000 volts per layer
- Withstands 500° F/260° C
- Flexible at -85° F/-65° C
- Mil-Spec-I - 46852

Wrap 'N Seal Silicone Tape is a self-fusing silicone tape suitable for many applications, including wrapping electrical connections and wire harnesses. The silicone tape only bonds to itself with no adhesive mess. It conforms to any shape and withstands UV rays, acids and fuels. Once wrapped, it bonds immediately, forming a permanent air and watertight seal. It becomes permanently fused in 24 hours.



| Catalog Number | Color | W | L |
|----------------|------------------|------|-----|
| 9200 | White | 1 in | 20' |
| 99201 | Red | 1 in | 20' |
| 99202 | Black | 1 in | 20' |
| 99205 | Green | 1 in | 20' |
| 99206 | Blue | 1 in | 20' |
| 99207 | Yellow | 1 in | 20' |
| 99208 | Clear | 1 in | 20' |
| 99209 | Glow in the Dark | 1 in | 20' |
| 99211 | Gray | 1 in | 20' |
| 99212 | Orange/Red | 1 in | 20' |

Heat Shrinkable Tubing

Heavy Wall with Adhesive Liner

RoHS
Compliant



TYPE

Heavy Wall

Features

- 3:1 shrink ratio
- UL Listed 486D and CSA Certified for 600 volts
- Inner adhesive liner
- Flame retardant

Benefits

- Provides a wide range of coverage when used on connectors and cable
- Ensures reliability for insulating terminations and splices
- Melts to form intimate contact with part to seal out elements and produce a watertight seal suitable for above ground, direct burial and underwater applications
- Meets Mil Spec 23053/15 rigid requirements for flame retardancy



| Catalog Number | Wire Range | Exp. Id. | Rec. Id. | Recovered Wall Thickness | L |
|----------------|--------------------|----------|----------|--------------------------|-------|
| 21106-B3* | 6-14 | 0.400 | 0.150 | 0.060 | 6 in |
| 21112-B3* | 6-14 | 0.400 | 0.150 | 0.060 | 12 in |
| 21206-B3 | 1-8 | 0.750 | 0.220 | 0.090 | 6 in |
| 21209-B3 | 1-8 | 0.750 | 0.220 | 0.090 | 9 in |
| 21212-B3 | 1-8 | 0.750 | 0.220 | 0.090 | 12 in |
| 21230 | 1-8 | 0.750 | 0.220 | 0.090 | 30 in |
| 21406-B2 | 4/0-2 | 1.100 | 0.375 | 0.120 | 6 in |
| 21409-B2 | 4/0-2 | 1.100 | 0.375 | 0.120 | 9 in |
| 21412-B2 | 4/0-2 | 1.100 | 0.375 | 0.120 | 12 in |
| 21448 | 4/0-2 | 1.100 | 0.375 | 0.120 | 48 in |
| 21609-B2 | 400kcmil-4/0 | 1.500 | 0.500 | 0.140 | 9 in |
| 21612-B2 | 400kcmil-4/0 | 1.500 | 0.500 | 0.140 | 12 in |
| 21648 | 400kcmil-4/0 | 1.500 | 0.500 | 0.140 | 48 in |
| 21709-B | 1000kcmil-500kcmil | 2.000 | 0.750 | 0.155 | 9 in |
| 21712-B | 1000kcmil-500kcmil | 2.000 | 0.750 | 0.155 | 12 in |
| 21748 | 1000kcmil-500kcmil | 2.000 | 0.750 | 0.155 | 48 in |

All wire sizes, unless noted otherwise, are American Wire Gauge (AWG)

*UL Listed wire range 12 - 6.

UL File E158587

Heat Shrinkable End Caps

Heavy Wall with Adhesive Liner

RoHS
Compliant

TYPE

Heavy Wall

Features

- 3:1 shrink ratio
- Inner adhesive liner
- Rated for 600 volts

Benefits

- Provides a wide range of coverage when used on connectors and cable
- Melts to form intimate contact with part to seal out elements and produce a watertight seal suitable for above ground, direct burial and underwater applications
- Ensures reliability

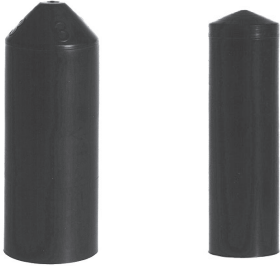

| Catalog Number | Wire Range | Exp. Id. | Rec. Id. | Recovered Wall Thickness | L |
|----------------|--------------------|----------|----------|--------------------------|--------|
| 23081-B2 | 4/0-8 | .75 | 0.22 | .08 | 3.5 in |
| 23125-B2 | 500kcmil-4/0 | 1.30 | 0.43 | .08 | 4.5 in |
| 23210-B2 | 1000kcmil-400kcmil | 2.05 | 0.75 | .08 | 4.5 in |

All wire sizes, unless noted otherwise, are American Wire Gauge (AWG)

Heat Shrinkable Clear Tubing

Medium Wall with Adhesive Liner

TYPE

Medium Wall

Features

- Clear tubing
- 2.5:1 shrink ratio
- Inner adhesive liner
- Rated for 600 volts

Benefits

- Provides convenient see through capability which gives assurance that termination was made properly after shrink process has been performed
- Provides a wide range of coverage when used on connectors and cable
- Melts to form intimate contact with part to seal out elements and produce a watertight seal suitable for above ground, direct burial and underwater applications
- Ensures reliability

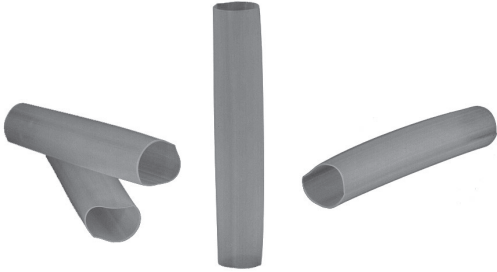

| Catalog Number | Wire Range | Exp. Id. | Rec. Id. | Recovered Wall Thickness | L |
|----------------|------------|----------|----------|--------------------------|-------|
| 22106-B3 | 14-18 | 0.290 | 0.080 | 0.047 | 6 in |
| 22112-B3 | 14-18 | 0.290 | 0.080 | 0.047 | 12 in |
| 22206-B3 | 8-12 | 0.375 | 0.135 | 0.050 | 6 in |
| 22212-B3 | 8-12 | 0.375 | 0.135 | 0.050 | 12 in |
| 22306-B3 | 2-8 | 0.500 | 0.195 | 0.055 | 6 in |
| 22312-B3 | 2-8 | 0.500 | 0.195 | 0.055 | 12 in |
| 22406-B2 | 4/0-1 | 1.000 | 0.400 | 0.075 | 6 in |
| 22412-B2 | 4/0-1 | 1.000 | 0.400 | 0.075 | 12 in |

All wire sizes, unless noted otherwise, are American Wire Gauge (AWG)



Heat Shrinkable Tubing

Thin Wall

RoHS
Compliant



TYPE Thin Wall

Features

- 2:1 shrink ratio
- UL Recognized and CSA Certified
- Rated for 600 volts
- Convenient disk dispenser

Benefits

- Provides a wide range of coverage when used on connectors and cable
- Assures product reliability for insulating and protecting terminations and splices
- Ensures reliability
- Protects tubing from damage and keeps it clean



| Catalog Number | Wire Range | Exp. Id. | Rec. Id. | Recovered Wall Thickness | L |
|----------------|------------|----------|----------|--------------------------|------------|
| 24001-B10 | 26-34 | 0.046 | 0.023 | 0.016 | 6 in |
| 24002-B10 | 24-30 | 0.063 | 0.031 | 0.017 | 6 in |
| 24003-B10 | 22-28 | 0.093 | 0.046 | 0.020 | 6 in |
| 24004-B10 | 20-26 | 0.125 | 0.062 | 0.020 | 6 in |
| 24005-B10 | 18-22 | 0.187 | 0.093 | 0.020 | 6 in |
| 24006-B10 | 14-16 | 0.250 | 0.125 | 0.025 | 6 in |
| 24007-B5 | 10-12 | 0.312 | 0.156 | 0.025 | 6 in |
| 24008-B5 | 6-8 | 0.375 | 0.187 | 0.025 | 6 in |
| 24009-B5 | 4-6 | 0.500 | 0.250 | 0.025 | 6 in |
| 24010-B5 | 2/0-2 | 0.750 | 0.375 | 0.030 | 6 in |
| 24011-B5 | 4/0-1 | 1.000 | 0.500 | 0.035 | 6 in |
| 24999-B12+ | - | - | - | - | - |
| 25001 | 26-34 | 0.046 | 0.023 | 0.016 | 96 in Disk |
| 25002 | 24-30 | 0.063 | 0.031 | 0.017 | 96 in Disk |
| 25003 | 22-28 | 0.093 | 0.046 | 0.020 | 96 in Disk |
| 25004 | 20-26 | 0.125 | 0.062 | 0.020 | 96 in Disk |
| 25005 | 18-22 | 0.187 | 0.093 | 0.020 | 96 in Disk |
| 25006 | 14-16 | 0.250 | 0.125 | 0.025 | 96 in Disk |
| 25007 | 10-12 | 0.3112 | 0.156 | 0.025 | 96 in Disk |
| 25008 | 6-8 | 0.375 | 0.187 | 0.025 | 96 in Disk |
| 25009 | 4-6 | 0.500 | 0.250 | 0.025 | 96 in Disk |
| 25010 | 2/0-2 | 0.750 | 0.375 | 0.030 | 96 in Disk |
| 25011 | 4/0-1 | 1.000 | 0.500 | 0.035 | 96 in Disk |

All wire sizes, unless noted otherwise, are American Wire Gauge (AWG)
+ 24999-B12 contains 3 ea. 24005, 24006, 24008, 24009
UL File E158587

Heat Shrinkable Tubing

Thin Wall

RoHS
Compliant



TYPE Thin Wall

Features

- 2:1 shrink ratio
- UL Recognized and CSA Certified
- Rated for 600 volts

Benefits

- Provides a wide range of coverage when used on connectors and cable
- Assures product reliability for insulating and protecting terminations and splices
- Ensures reliability



| Catalog Number | Wire Range | Exp. Id. | Rec. Id. | Recovered Wall Thickness | Cut Length |
|----------------|------------|----------|----------|--------------------------|------------|
| 26001 | 26-34 | 0.046 | 0.023 | 0.016 | 1000' |
| 26002 | 24-30 | 0.063 | 0.031 | 0.017 | 1000' |
| 26003 | 22-28 | 0.093 | 0.046 | 0.020 | 500' |
| 26004 | 20-26 | 0.125 | 0.062 | 0.020 | 500' |
| 26005 | 18-22 | 0.187 | 0.093 | 0.020 | 200' |
| 26006 | 14-16 | 0.250 | 0.125 | 0.025 | 200' |
| 26007 | 10-12 | 0.312 | 0.156 | 0.025 | 500' |
| 26008 | 6-8 | 0.375 | 0.187 | 0.025 | 200' |
| 26009 | 4-6 | 0.500 | 0.250 | 0.025 | 200' |
| 26010 | 2/0-2 | 0.750 | 0.375 | 0.030 | 200' |
| 26011 | 4/0-1 | 1.000 | 0.500 | 0.035 | 200' |

All wire sizes, unless noted otherwise, are American Wire Gauge (AWG)

TYPE
**Electric
Heat Gun**

Features

- Two temperature settings 750F and 1100F
- Three way switch OFF/HI/LO
- Built-in fold down stand
- 1200 Watt 120 V AC
- Heat deflector
- Impact resistant
- Six foot cord

Benefits

- Provides versatility in applying recommended heat, deliverable in seconds
- Aids in producing proper air flow from heat gun
- Provides hands free operation
- Provides high output of air and heat
- Allows for concentration of heat for rapid heat shrink process
- Provides extra durability in harsh environments
- Provides operator convenience



| Catalog Number | Description |
|----------------|--------------------------------------------------------------------------|
| 27001 | Heat Gun, 11 Disks Thin Wall Heat Shrink varying sizes, 94145 Crimp Tool |
| 94502 | Electric Heat Gun 120v |
| 94504 | Replacement Adaptor for 94502 |

Tools

| | | | | |
|------------------------------------------------------------------------------------------------------------------------|------------------------------------------------------------------------------------------------------------------------|----------------------------------------------------------------------------------------------------------------------------------------|------------------------------------------------------------------------------------------------------------------|------------------------------------------------------------------------------------------------------------------|
| <p>TACCI</p>  <p>347</p> | <p>BCTI</p>  <p>348-349</p> | <p>BCTI</p>  <p>350</p> | <p>BCTI</p>  <p>351</p> | <p>BCTR</p>  <p>352-361</p> |
| <p>HDTI</p>  <p>362-363</p> | <p>MHCT</p>  <p>364-365</p> | <p>HRTI</p>  <p>366-367</p> | <p>HRCT</p>  <p>368-370</p> | <p>HPI</p>  <p>371-373</p> |
| <p>HPI ACCESSORIES</p>  <p>374</p> | <p>DIE KIT</p>  <p>375</p> | <p>COMPRESSION DIES AND ADAPTORS</p>  <p>376-378</p> | <p>DINO DIES</p>  <p>379</p> | <p>W-DIES</p>  <p>380</p> |
| <p>MT-25</p>  <p>381</p> | <p>ND-58</p>  <p>382</p> | <p>ND-60</p>  <p>383</p> | <p>94285</p>  <p>384</p> | <p>ILC-10-N</p>  <p>385</p> |
| <p>94130, 94145</p>  <p>386</p> | <p>THT-SC-CC</p>  <p>387</p> | <p>WSI</p>  <p>388</p> | <p>WSI</p>  <p>389-395</p> | <p>CTRI</p>  <p>396</p> |
| <p>CTR-500, CTR-750</p>  <p>397</p> | <p>MECHANICAL TOOLS</p>  <p>398</p> | <p>HEAT GUN</p>  <p>399</p> | <p>COMPRESSION INDEX</p> <p>400 - 407</p> | |

nVent ILSCO TaskMaster Tools 6 Ton Pressure Gauge

RoHS
Compliant

TYPE TACCI

Features

- nVent ILSCO TaskMasterPRO five year tool warranty
- Measures force at point of crimp
- Fits directly into most W-Die taking tool jaws
- Assembled with cushioned gauge cover
- Sturdy molded carrying case
- Holds pressure reading
- Patent pending

Benefits

- Ensures confidence for durability & quality
- Shows actual force instead of calculation
- Ease of use and versatility
- Shock absorption to protect against damage
- Protection against damage and mis-calibration
- Confirms force, after releasing from tool

TPG-6T-I



Catalog Number

| | |
|-------------|-------------------------------------|
| TPG-6T-I | 6 Ton Pressure Gauge Kit |
| SILGR-100ML | Replacement Silicone Grease 3.4 oz. |

Specifications

| | |
|----------------------|-----------|
| Weight | 3.32 lbs. |
| Length | 7.8 in |
| Height | 2.15 in |
| Width | 2.87 in |
| Measuring Capability | 6 tons |

Kit Includes:

- Pressure Gauge
- Molded Carrying Case
- Silicone Grease (3.4 oz.)
- Specific Control Certification

For Use On:

TB-6WO500-I
TB-6WBG500-I
TB-6WD3500-I
Most battery powered 6 ton pincher design W-Die taking tool jaws

J

nVent ILSCO TaskMaster Tools 6-Ton Battery Powered In-Line Crimping Tool

RoHS
Compliant

TYPE BCTI

Features

- nVent ILSCO TaskMasterPRO five year tool warranty
- 18 V, 5.0 Ah Milwaukee Li-ion battery, 3 year warranty
- Accepts all "W" and "X" type die
- Brush protection on tool head
- AutoRetract when 6 tons achieved
- DataTrack mini USB-port for connectivity
- Interchangeable heads with O, BG, D3 or no die
- 350° tool head rotation
- Right or left hand ergonomic non-slip cushioned grip
- Multifunction LED indication lights
- LED battery charge indicator
- Tested up to 75K volts

Benefits

- Ensures confidence for durability & quality
- Longevity
- Industry standard
- Protection against accidental contact with energized conductors
- Confirms complete crimp
- Capture output data for performance & service
- Application versatility
- Maneuverability
- Reduces fatigue and increases grip security
- Identifies condition and readiness of tool
- Job site battery management
- Can be used on energized lines

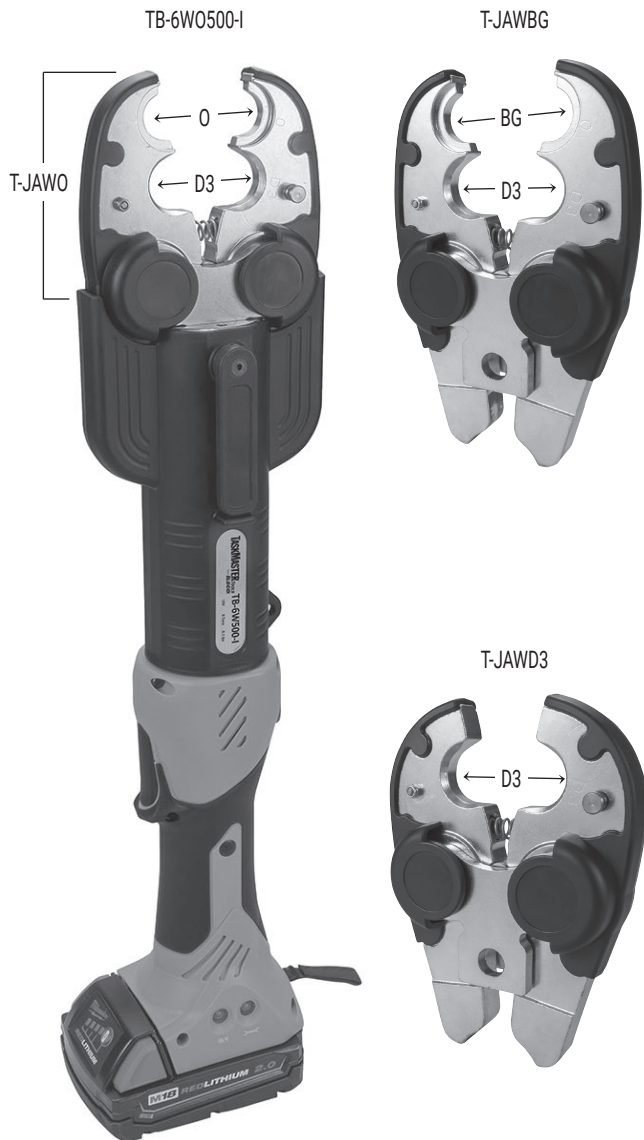

| Catalog Number | | |
|----------------------------|----------------------------------------|--------|
| TB-6W0500-I | Tool Kit w/O-Nose Jaw | |
| TB-6W0500-IX | Tool Kit w/o batteries and charger | |
| TB-6WBG500-I | Tool Kit w/BG-Nose Jaw | |
| TB-6WBG500-IX | Tool Kit w/o batteries and charger | |
| TB-6WD3500-I | Tool Kit w/D3 Jaw | |
| TB-6WD3500-IX | Tool Kit w/o batteries and charger | |
| T-JAWO | Jaw only w/O-Nose & D3 Nest | |
| T-JAWBG | Jaw only w/BG-Nose & D3 Nest | |
| T-JAWD3 | Jaw only w/D3 Nest | |
| Specifications | | |
| Force Developed | 6 tons | |
| Weight with 5.0 Ah battery | 8.7 lbs. | |
| Length | 20 in | |
| Height | 3.1 in | |
| Width | 5.2 in | |
| Connector Range | | |
| Lugs and Splices | 500 kcmil - #8 Cu 350 kcmil - #8 Al | |
| H-Taps | 4/0 - 4/0 Al Max | |
| Battery Life Estimates | | |
| Battery | Connector | Crimps |
| 18V-2.0 Ah | 4/0-4/0 Al H-Tap | 120 |
| 18V-5.0 Ah | 4/0-4/0 Al H-Tap | 300 |

Kit Includes:

- Tool with Crimp Jaw
- 2 Milwaukee Batteries - 18V 5.0 Ah
- 1 Milwaukee Battery Charger - 120V AC
- Shoulder Strap
- Molded Carrying Case
- Instruction Manual
- USB Cord
- Specific Control Certification

nVent ILSCO TaskMaster Tools Interchangeable Cutting Jaw - Copper/Aluminum

RoHS
Compliant

TYPE
BCTI

Features

- nVent ILSCO TaskMasterPRO five year tool warranty
- SmartCut detection w/Auto Retract
- 360° tool head rotation
- Toolless Swap
- One-Cycle Cut
- Compatible with all nVent ILSCO TB-6W series In-line tools
- Provides ability to crimp and cut with the same tool
- Single jaw for cutting both Copper and Aluminum conductors

Benefits

- Ensures confidence for durability & quality
- Less stress on motor and hydraulics
- Maneuverability
- Crimping jaw can be easily removed from the tool to swap on the cutting jaw. No tools required
- 6-ton tool will be available with an additional cutting mode. Save time on job
- Most complete crimping and cutting tool platform on the market



T-JAWCUAL - Cu/Al cutting Jaw only

Compatible with:

| | |
|----------------|---------------------------------------------|
| TB-6W0500-I | Crimping Tool Kit w/O-Nose Jaw |
| TB-6W0500-IX | Crimping Tool Kit w/o batteries and charger |
| TB-6WBG500-I | Crimping Tool Kit w/BG-Nose Jaw |
| TB-6WBG500-IX | Crimping Tool Kit w/o batteries and charger |
| TB-6WD3500-I | Crimping Tool Kit w/D3 Jaw |
| TB-6WD3500-IX | Crimping Tool Kit w/o batteries and charger |
| TB-6XPJ1/0-I | Crimping Tool Kit w/XPJ Jaw |
| TB-6XPJ1/0-IX | Crimping Tool Kit w/o batteries and charger |
| TB-6W500BODY-I | In-Line Crimping Tool w/o jaws |

Specifications

| | |
|------------------|-----------|
| Cutting Diameter | 1.5 in |
| Weight | 3.19 lbs. |
| Length | 4.5 in |
| Height | 2 in |
| Width | 2 in |

Cutting Capacity

| | |
|--------------|----------------|
| CU Conductor | 750 kcmil max |
| AL Conductor | 1000 kcmil max |

Battery Life Estimates

| | |
|------------|-------------------|
| Battery | 750 kcmil CU Wire |
| 18V-2.0 Ah | 150 Cuts |
| 18V-5.0 Ah | 340 Cuts |

DO NOT CUT:

ACSR Cable, Steel, Ground Rod, Rebar or Guy Wire

J

nVent ILSCO TaskMaster Tools 6-Ton Battery Powered Dieless Crimping Tool

TYPE BCTI

Features

- nVent ILSCO TaskMasterPRO five year tool warranty
- 18 V, 5.0 Ah Milwaukee Li-ion battery, 3 year warranty
- 360° tool head rotation
- Right or left hand ergonomic non-slip cushioned grip
- LED work light
- LED battery charge indicator
- Variable speed trigger
- Dieless crimping operation
- Flip top head

Benefits

- Ensures confidence for durability & quality
- Longevity
- Maneuverability
- Reduces fatigue and increases grip security
- Illuminates work space
- Job site battery management
- Easier positioning on connector
- Versatility, works on large range of wire sizes
- Easy connector loading and unloading

TB-6DF1000-P



| Catalog Number | |
|----------------------------|------------------------------------|
| TB-6DF1000-P | Tool Kit |
| TB-6DF1000-PX | Tool Kit w/o batteries and charger |
| Specifications | |
| Force Developed | 6 tons |
| Weight with 5.0 Ah battery | 14 lbs. |
| Length | 17 in |
| Height | 13 in |
| Width | 3.1 in |
| Head opening | 1.55 in |
| Crimp Range | Lugs & Splices |
| CU Conductor | 1000 kcmil - #8 sol/str |
| AL Conductor | 750 kcmil - #8 str |
| Battery Life Estimates | Number of Cycles |
| 18V DC - 5.0 Ah | 200 |

Kit Includes:

- Tool
- 2 Milwaukee Batteries - 18V 5.0 Ah
- 1 Milwaukee Battery Charger - 120V AC
- Shoulder Strap
- Molded Carrying Case
- Instruction Manual
- Specific Control Certification

nVent ILSCO TaskMaster Tools 12-Ton Battery Powered Pistol Grip Crimping Tool

RoHS
Compliant

TYPE
BCTI

Features

- nVent ILSCO TaskMasterPRO five year tool warranty
- 18 V, 5.0 Ah Milwaukee Li-ion battery, 3 year warranty
- Accepts "U" type dies
- 360° tool head rotation
- Right or left hand ergonomic non-slip cushioned grip
- LED work light
- LED battery charge indicator
- Variable speed trigger

Benefits

- Ensures confidence for durability & quality
- Longevity
- Flexibility in the field
- Maneuverability
- Reduces fatigue and increases grip security
- Illuminates work space
- Job site battery management
- Easier positioning on connector

TB-12U1000-P



| Catalog Number | |
|----------------------------|------------------------------------|
| TB-12U1000-P | Tool Kit |
| TB-12U1000-PX | Tool Kit w/o batteries and charger |
| Specifications | |
| Force Developed | 12 tons |
| Weight with 5.0 Ah battery | 15.9 lbs. |
| Length | 16.4 in |
| Height | 13 in |
| Width | 3.1 in |
| Jaw opening | 1.65 in |
| Crimp Range | Lugs & Splices |
| CU Conductor | 1000 kcmil - #8 sol/str |
| AL Conductor | 750 kcmil - #8 str |
| Battery Life Estimates | Number of Cycles |
| 18V DC - 5.0 Ah | 200 |

For Use With

| Aluminum Connectors | Copper Connectors | Visual Identification |
|------------------------------------|--------------------------------|-----------------------|
| Series: ALNS, ALND | Series: CLN4, CLN9, CLND, CLWU | |
| ALNN thru 750kcmil | CLNF, CLNN, CLNS | |
| Series: IACL, 2IACL thru 750kcmil | CLNU, CLWD, CLW4, CLW9 | |
| * Series: 2ACL, 2ACN thru 750kcmil | CLWN, CLWS, CLW9 | |
| Series: ACL, ACN thru 750kcmil | CSNF, CSNS, CSLT | |
| | CSWD, CSWN, CSWS, CSW4, CSW9 | |
| Series: *ASN, AS | CT, CTL | |
| CPM Series | | |
| CPML Series | | |
| ACO-90 Series | | |
| ACM Series | | |
| ACO Series | | |
| AH 1-4 | | |
| * HT Series | | |
| | GGA Series | |
| | GGB Series | |
| | ELT Series | |
| | GGC Series | |
| | ULT Series | |
| | RLT Series | |

All wire sizes, unless noted otherwise, are American Wire Gauge (AWG)

Kit Includes:

- Tool
- 2 Milwaukee Batteries - 18V 5.0 Ah
- 1 Milwaukee Battery Charger - 120V AC
- Shoulder Strap
- Molded Carrying Case
- Instruction Manual
- Specific Control Certification

nVent ILSCO TaskMaster Tools Battery Powered Pistol Grip Cutting Tool

RoHS
Compliant

TYPE BCTR

Features

- nVent ILSCO TaskMasterPRO five year tool warranty
- 18 V, 5.0 Ah Milwaukee Li-ion battery, 3 year warranty
- 360° tool head rotation
- Right or left hand ergonomic non-slip cushioned grip
- LED work light
- LED battery charge indicator
- Variable speed trigger
- Latch head design
- Heavy duty blades

Benefits

- Ensures confidence for durability & quality
- Longevity
- Maneuverability
- Reduces fatigue and increases grip security
- Illuminates work space
- Job site battery management
- Easier positioning of cut
- Secures conductor in place
- Able to cut through hard steel

TB-CUT25-P



| Catalog Number | |
|--------------------------------|-------------------------------------------------------|
| TB-CUT25-P | Tool Kit |
| TB-CUT25-PX | Tool Kit w/o batteries and charger |
| BLDF-25HD | Replacement Fixed Blade |
| BLDM-25 | Replacement Moving Blade |
| Specifications | |
| Force Developed | 6.7 tons |
| Weight with 5.0 Ah battery | 9.25 lbs. |
| Length | 14 in |
| Height | 13 in |
| Width | 3 in |
| Cutting Diameter | .98 in |
| Cut Capacity (CU or AL) | .98 in |
| ACSR | 556 kcmil |
| Guy Wire | 9/16 in |
| Guy Wire (EHS) | 9/16 in |
| Ground Rod | 5/8 in |
| Rebar | #5 (5/8 in) Grade 40 For Grade 60, Consult Factory |
| Battery Life Estimates | |
| 18V DC – 5.0 Ah | 340 Cycles |

Kit Includes:

- Tool
- 2 Milwaukee Batteries - 18V 5.0 Ah
- 1 Milwaukee Battery Charger – 120V AC
- Shoulder Strap
- Molded Carrying Case
- Instruction Manual
- Specific Control Certification



nVent ILSCO TaskMaster Tools Battery Powered Pistol Grip Cutting Tool

RoHS
Compliant

TYPE
BCTR

Features

- nVent ILSCO TaskMasterPRO five year tool warranty
- 18 V, 5 Ah Milwaukee Li-ion battery, 3 year warranty
- 350° tool head rotation
- Right or left hand ergonomic non-slip cushioned grip
- LED work light
- LED battery charge indicator
- Variable speed trigger
- Latch head design

Benefits

- Ensures confidence for durability & quality
- Longevity
- Easy maneuvering at any angle
- Reduces fatigue and increases grip security
- Illuminates work space
- Job site battery management
- Easier positioning of cut
- Secures conductor in place

TB-CUT45-P



Catalog Number

| | |
|-------------|------------------------------------|
| TB-CUT45-P | Tool Kit |
| TB-CUT45-PX | Tool Kit w/o batteries and charger |
| BLDF-45 | Replacement Fixed Blade |
| BLDM-45 | Replacement Moving Blade |

Specifications

| | |
|----------------------------|----------|
| Force Developed | 6.7 tons |
| Weight with 5.0 Ah battery | 12 lbs. |
| Length | 17 in |
| Height | 13 in |
| Width | 3 in |
| Cutting Diameter | 1.77 in |

Cut Capacity (CU or AL)

| | |
|----------------|----------------------|
| ACSR | 1590 |
| Guy Wire | 5/8 in |
| Guy Wire (EHS) | 1/2 in |
| Ground Rod | 5/8 in |
| Rebar | #4 (1/2 in) Grade 60 |

Battery Life Estimates

Number of Cycles

| | |
|-----------------|------------|
| 18V DC – 5.0 Ah | 320 Cycles |
|-----------------|------------|

Kit Includes:

- Tool
- 2 Milwaukee Batteries - 18V 5.0 Ah
- 1 Milwaukee Battery Charger – 120V AC
- Shoulder Strap
- Molded Carrying Case
- Instruction Manual
- Specific Control Certification

J

nVent ILSCO TaskMaster Tools Battery Powered Pistol Grip Cutting Tool

TYPE BCTR

Features

- nVent ILSCO TaskMasterPRO five year tool warranty
- 18 V, 5.0 Ah Milwaukee Li-ion battery, 3 year warranty
- 350° tool head rotation
- Right or left hand ergonomic non-slip cushioned grip
- LED work light
- LED battery charge indicator
- Variable speed trigger
- Latch head design

Benefits

- Ensures confidence for durability & quality
- Longevity
- Maneuverability
- Reduces fatigue and increases grip security
- Illuminates work space
- Job site battery management
- Easier positioning of cut
- Secures conductor in place

TB-CUT50CU-P



Catalog Number

| | |
|---------------|------------------------------------|
| TB-CUT50CU-P | Tool Kit |
| TB-CUT50CU-PX | Tool Kit w/o batteries and charger |
| BLDF-50 | Replacement Fixed Blade |
| BLDM-50 | Replacement Moving Blade |

Specifications

| | |
|----------------------------|----------|
| Force Developed | 6.7 tons |
| Weight with 5.0 Ah battery | 12 lbs. |
| Length | 17.5 in |
| Height | 13 in |
| Width | 3 in |
| Cutting Diameter | 1.96 in |

Cut Capacity (CU or AL)

| | |
|--------------|--------|
| CU Conductor | 1.9 in |
| AL Conductor | 1.9 in |
| Lead Sheath | 1.9 in |

Battery Life Estimates

Number of Cycles

| | |
|-----------------|----------|
| 18V DC - 5.0 Ah | 300 Cuts |
|-----------------|----------|

Kit Includes:

- Tool
- 2 Milwaukee Batteries - 18V 5.0 Ah
- 1 Milwaukee Battery Charger - 120V AC
- Shoulder Strap
- Molded Carrying Case
- Instruction Manual
- Specific Control Certification

DO NOT CUT:

ACSR Cable, Steel, Ground Rod, Rebar or Guy Wire

nVent ILSCO TaskMaster Tools Battery Powered Pistol Grip Cutting Tool

RoHS
Compliant

TYPE
BCTR

Features

- nVent ILSCO TaskMasterPRO five year tool warranty
- 18 V, 5 Ah Milwaukee Li-ion battery, 3 year warranty
- 350° tool head rotation
- Right or left hand ergonomic non-slip cushioned grip
- LED work light
- LED battery charge indicator
- Variable speed trigger
- Latch head design

Benefits

- Ensures confidence for durability & quality
- Longevity
- Easy maneuvering at any angle
- Reduces fatigue and increases grip security
- Illuminates work space
- Job site battery management
- Easier positioning of the cut
- Secures conductor in place

TB-CUT85CU-P

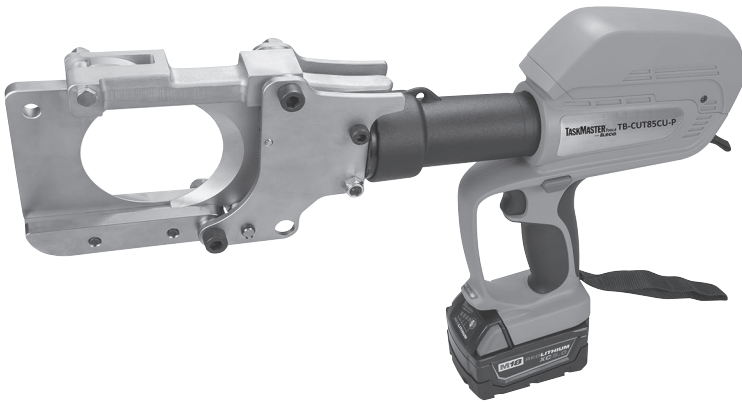

Catalog Number

| | |
|---------------|------------------------------------|
| TB-CUT85CU-P | Tool Kit |
| TB-CUT85CU-PX | Tool Kit w/o batteries and charger |
| BLDF-85 | Replacement Fixed Blade |
| BLDM-85 | Replacement Moving Blade |

Specifications

| | |
|----------------------------|-----------|
| Force Developed | 7.8 tons |
| Weight with 5.0 Ah battery | 14.8 lbs. |
| Length | 20.5 in |
| Height | 13 in |
| Width | 3 in |
| Cutting Diameter | 3.3 in |

Cut Capacity (CU or AL)

| | |
|--------------|------|
| CU Conductor | 3 in |
| AL Conductor | 3 in |
| Lead Sheath | 3 in |

Battery Life Estimates

Number of Cycles

| | |
|-----------------|------------|
| 18V DC - 5.0 Ah | 280 Cycles |
|-----------------|------------|

Kit Includes:

- Tool
- 2 Milwaukee Batteries - 18V 5.0 Ah
- 1 Milwaukee Battery Charger - 120V AC
- Shoulder Strap
- Molded Carrying Case
- Instruction Manual
- Specific Control Certification

J

DO NOT CUT:

ACSR Cable, Steel, Ground Rod, Rebar or Guy Wire

nVent ILSCO TaskMaster Tools Battery Powered Pistol Grip Cutting Tool

TYPE BCTR

Features

- nVent ILSCO TaskMasterPRO five year tool warranty
- 18 V, 5 Ah Milwaukee Li-ion battery, 3 year warranty
- 360° tool head rotation
- Right or left hand ergonomic non-slip cushioned grip
- LED work light
- LED battery charge indicator
- Variable speed trigger
- Scissor head design

Benefits

- Ensures confidence for durability & quality
- Longevity
- Easy maneuvering at any angle
- Reduces fatigue and increases grip security
- Illuminates work space
- Job site battery management
- Easier positioning of the cut
- One handed operation

TB-CUT65CU-PS



Catalog Number

| | |
|----------------|------------------------------------|
| TB-CUT65CU-PS | Tool Kit |
| TB-CUT65CU-PSX | Tool Kit w/o batteries and charger |
| BLDS-65 | Replacement Blade Assembly |
| BLDG-65 | Replacement Blade Guide |

Specifications

| | |
|----------------------------|------------|
| Force Developed | 4.9 tons |
| Weight with 5.0 Ah battery | 16.75 lbs. |
| Length | 19.75 in |
| Height | 13 in |
| Width | 3.4 in |
| Cutting Diameter | 2.5 in |

Cut Capacity (CU or AL)

| | |
|--------------|------------|
| CU Conductor | 1000 kcmil |
| AL Conductor | 2.5 in |
| Lead Sheath | 2.5 in |

Battery Life Estimates

Number of Cycles

| | |
|-----------------|------------|
| 18V DC - 5.0 Ah | 280 Cycles |
|-----------------|------------|

Kit Includes:

- Tool
- 2 Milwaukee Batteries - 18V 5.0 Ah
- 1 Milwaukee Battery Charger - 120V AC
- Shoulder Strap
- Molded Carrying Case
- Instruction Manual
- Specific Control Certification

DO NOT CUT:

ACSR Cable, Steel, Ground Rod, Rebar or Guy Wire

nVent ILSCO TaskMaster Tools Battery Powered Pistol Grip Cutting Tool

RoHS
Compliant

TYPE
BCTR

Features

- nVent ILSCO TaskMasterPRO five year tool warranty
- 18 V, 5 Ah Milwaukee Li-ion battery, 3 year warranty
- 360° tool head rotation
- Right or left hand ergonomic non-slip cushioned grip
- LED work light
- LED battery charge indicator
- Variable speed trigger
- Scissor head design

Benefits

- Ensures confidence for durability & quality
- Longevity
- Easy maneuvering at any angle
- Reduces fatigue and increases grip security
- Illuminates work space
- Job site battery management
- Easier positioning of the cut
- One handed operation

TB-CUT95CU-PS



Catalog Number

| | |
|----------------|------------------------------------|
| TB-CUT95CU-PS | Tool Kit |
| TB-CUT95CU-PSX | Tool Kit w/o batteries and charger |
| BLDS-95 | Replacement Blade Assembly |
| BLDG-95 | Replacement Blade Guide |

Specifications

| | |
|----------------------------|-----------|
| Force Developed | 7.3 tons |
| Weight with 5.0 Ah battery | 21.6 lbs. |
| Length | 19.76 in |
| Height | 13 in |
| Width | 3.5 in |
| Cutting Diameter | 3.75 in |

Cut Capacity (CU or AL)

| | |
|--------------|------------|
| CU Conductor | 1000 kcmil |
| AL Conductor | 3.5 in |
| Lead Sheath | 2.5 in |

Battery Life Estimates

Number of Cycles

| | |
|-----------------|------------|
| 18V DC - 5.0 Ah | 240 Cycles |
|-----------------|------------|

Kit Includes:

- Tool
- 2 Milwaukee Batteries - 18V 5.0 Ah
- 1 Milwaukee Battery Charger - 120V AC
- Shoulder Strap
- Molded Carrying Case
- Instruction Manual
- Specific Control Certification

J

DO NOT CUT:

ACSR Cable, Steel, Ground Rod, Rebar or Guy Wire

nVent ILSCO TaskMaster Tools Battery Powered Pistol Grip Cutting Tool

TYPE BCTR

Features

- nVent ILSCO TaskMasterPRO five year tool warranty
- 18 V, 5 Ah Milwaukee Li-ion battery, 3 year warranty
- 360° tool head rotation
- Right or left hand ergonomic non-slip cushioned grip
- LED work light
- LED battery charge indicator
- Variable speed trigger
- Scissor head design

Benefits

- Ensures confidence for durability & quality
- Longevity
- Easy maneuvering at any angle
- Reduces fatigue and increases grip security
- Illuminates work space
- Job site battery management
- Easier positioning of the cut
- One handed operation

TB-CUT120CU-PS



Catalog Number

| | |
|-----------------|------------------------------------|
| TB-CUT120CU-PS | Tool Kit |
| TB-CUT120CU-PSX | Tool Kit w/o batteries and charger |
| BLDF-120 | Replacement Blade Assembly |
| BLDM-120 | Replacement Moving Blade |

Specifications

| | |
|----------------------------|-----------|
| Force Developed | 6.7 tons |
| Weight with 5.0 Ah battery | 21.5 lbs. |
| Length | 25.6 in |
| Height | 13 in |
| Width | 3.75 in |
| Cutting Diameter | 4.75 in |

Cut Capacity (CU or AL)

| | |
|------------------------|------------------|
| CU Conductor | 1000 kcmil |
| AL Conductor | 4.5 in |
| Battery Life Estimates | Number of Cycles |
| 18V DC - 5.0 Ah | 220 Cuts |

Kit Includes:

- Tool
- 2 Milwaukee Batteries - 18V 5.0 Ah
- 1 Milwaukee Battery Charger - 120V AC
- Shoulder Strap
- Molded Carrying Case
- Instruction Manual
- Specific Control Certification

DO NOT CUT:

ACSR Cable, Steel, Ground Rod, Rebar or Guy Wire

nVent ILSCO TaskMaster Tools Battery Powered In-Line Cutting Tool

RoHS
Compliant

TYPE BCTR

Features

- nVent ILSCO TaskMasterPRO five year tool warranty
- 18 V, 2.0 Ah Milwaukee Li-ion battery, 3 year warranty
- 360° tool head rotation
- DataTrack mini USB-port for connectivity
- Right or left hand ergonomic non-slip cushioned grip
- Multifunction LED indication lights
- LED battery charge indicator
- Latch head design
- Heavy duty blades

Benefits

- Ensures confidence for durability & quality
- Longevity
- Maneuverability
- Capture output data for performance & service
- Reduces fatigue and increases grip security
- Identifies condition and readiness of tool
- Job site battery management
- Secures conductor in place
- Able to cut through hard steel

TB-CUT25HD



| Catalog Number | |
|----------------------------|------------------------------------|
| TB-CUT25HD-I | Tool Kit |
| TB-CUT25HD-IX | Tool Kit w/o batteries and charger |
| BLDF-25HD | Replacement Fixed Blade |
| BLDM-25 | Replacement Moving Blade |
| Specifications | |
| Force Developed | 6.7 tons |
| Weight with 2.0 Ah battery | 8.3 lbs. |
| Length | 15.62 in |
| Height | 2.5 in |
| Width | 3 in |
| Cutting Diameter | .98 in |
| Cut Capacity (CU or AL) | |
| ACSR | 556 kcmil |
| Guy Wire | 9/16 in |
| Guy Wire (EHS) | 9/16 in |
| Ground Rod | 5/8 in |
| Rebar | #5 (5/8 in) Grade 40 |
| Battery Life Estimates | |
| 18V DC – 2.0 Ah | 150 Cycles |
| 18V DC – 5.0 Ah (Optional) | 340 Cycles |

Kit Includes:

- Tool
- 2 Milwaukee Batteries - 18V 2.0 Ah
- 1 Milwaukee Battery Charger – 120V AC
- Shoulder Strap
- Molded Carrying Case
- Instruction Manual
- USB Cord
- Specific Control Certification

J

nVent ILSCO TaskMaster Tools Battery Powered In-Line Cutting Tool

TYPE BCTR

Features

- nVent ILSCO TaskMasterPRO five year tool warranty
- 18 V, 2.0 Ah Milwaukee Li-ion battery, 3 year warranty
- SmartCut detection w/Auto Retract
- 360° tool head rotation
- DataTrack mini USB-port for connectivity
- Right or left hand ergonomic non-slip cushioned grip
- Multifunction LED indication lights
- LED battery charge indicator
- Scissor head design

Benefits

- Ensures confidence for durability & quality
- Longevity
- Less stress on motor and hydraulics
- Maneuverability
- Capture output data for performance & service
- Reduces fatigue and increases grip security
- Identifies condition and readiness of tool
- Job site battery management
- One handed operation

TB-CUT40CU-IS



Catalog Number

| | |
|----------------|------------------------------------|
| TB-CUT40CU-IS | Tool Kit |
| TB-CUT40CU-ISX | Tool Kit w/o batteries and charger |
| BLDS-40 | Replacement Blade Set |

Specifications

| | |
|----------------------------|----------|
| Force Developed | 3.3 tons |
| Weight with 2.0 Ah battery | 6.2 lbs. |
| Length | 17.32 in |
| Height | 3.1 in |
| Width | 4.8 in |
| Cutting Diameter | 1.5 in |

Cut Capacity (CU or AL)

| | |
|--------------|----------------|
| CU Conductor | 750 kcmil max |
| AL Conductor | 1000 kcmil max |

Battery Life Estimates

Number of Cycles

| | |
|-----------------|----------|
| 18V DC - 2.0 Ah | 150 Cuts |
| 18V DC - 5.0 Ah | 340 Cuts |

Kit Includes:

- Tool
- 2 Milwaukee Batteries - 18V 2.0 Ah
- 1 Milwaukee Battery Charger - 120V AC
- Shoulder Strap
- Molded Carrying Case
- Instruction Manual
- USB Cord
- Specific Control Certification

J

DO NOT CUT:

ACSR Cable, Steel, Ground Rod, Rebar or Guy Wire

nVent ILSCO TaskMaster Tools Battery Powered In Line Cutting Tool

RoHS
Compliant

TYPE BCTR

Features

- nVent ILSCO TaskMasterPRO five year tool warranty
- Scissor head design for cutting ACSR and Guy Wire
- 3 year warranty, 18V, 2.0 Ah Milwaukee Li-ion battery
- 350° tool head rotation
- Heavy duty blade inserts
- DataTrack mini USB-port for connectivity
- Right or left hand ergonomic non-slip cushioned grip
- Multifunction LED indication lights
- LED battery charge indicator

Benefits

- Ensures confidence for durability & quality
- One handed operation, no latch required
- Longevity
- Easy maneuvering at any angle
- Easy field replacement
- Capture output data for performance & service
- Reduces fatigue and increases grip security
- Identifies condition and readiness of tool
- Allows for job site battery management

TB-CUT26ACSR-IS



Catalog Number

| | |
|------------------|------------------------------------|
| TB-CUT26ACSR-IS | Tool Kit |
| TB-CUT26ACSR-ISX | Tool Kit w/o batteries and charger |
| BLDS-26 | Replacement Blade Assembly |
| BLDI-26 | Replacement Blade Insert |

Specifications

| | |
|----------------------------|----------|
| Force Developed | 5.8 tons |
| Weight with 2.0 Ah battery | 9.2 lbs. |
| Length | 18 in |
| Height | 3.23 in |
| Width | 4.96 in |
| Cutting Diameter | 1.00 in |

Cut Capacity (CU or AL)

| | |
|----------------|----------------|
| ACSR | 556 kcmil max* |
| Guy Wire | 3/8 in |
| Guy Wire (EHS) | 3/8 in max |

Battery Life Estimates

Number of Cycles

| | |
|---------------|-----------------------|
| 18V DC-2.0 Ah | 80 Cuts (on 556-ACSR) |
|---------------|-----------------------|

* Will not cut 477 Hen

Kit Includes:

- Tool
- 2 Milwaukee Batteries - 18V 2.0 Ah
- 1 Milwaukee Battery Charger - 120V AC
- Shoulder Strap
- Molded Carrying Case
- Instruction Manual
- USB Cord
- Specific Control Certification

Not recommended for: CU, AL

Do not use on: Ground Rod, Rebar, 477 Hen

nVent ILSCO TaskMaster Tools Manual Hydraulic Dieless Crimping Tool

RoHS
Compliant

TYPE
HDTI

Features

- nVent ILSCO TaskMasterPRO five year tool warranty
- 2 Stage pump piston
- 360° tool head rotation
- Lightweight design
- Comfort grips
- Dieless crimping operation
- Flip top head

Benefits

- Ensures confidence for durability & quality
- Rapid advance
- Maneuverability
- Portability
- Shock absorption
- Versatility, works on large range of wire sizes
- Easy connector loading and unloading

TM-6DF1000



Catalog Number

TM-6DF1000

Specifications

Force Developed 6 tons

Weight 13.3 lbs.

Length 23.7 in

Head Opening 1.55 in

Crimp Range

Lugs & Splices

CU Conductor

1000 kcmil - #8 sol/str

AL Conductor

750 kcmil - #8 str

Includes:

- Molded Carrying Case
- Instruction Manual
- Specific Control Certification

J

nVent ILSCO TaskMaster Tools Manual Hydraulic Crimping Tool

RoHS
Compliant

TYPE
HDTI

Features

- nVent ILSCO TaskMasterPRO five year tool warranty
- 2 Stage pump piston
- 360° tool head rotation
- Lightweight design
- Accepts U-type dies
- Comfort grips

Benefits

- Ensures confidence for durability & quality
- Rapid advance
- Maneuverability
- Portability
- Flexibility in the field
- Shock absorption

TM-12U1000



| Catalog Number | |
|-----------------|-------------------------|
| TM-12U1000 | |
| Specifications | |
| Force Developed | 12 tons |
| Weight | 14.5 lbs. |
| Length | 23 in |
| Jaw Opening | 1.65 in |
| Crimp Range | Lugs & Splices |
| CU Conductor | 1000 kcmil - #8 sol/str |
| AL Conductor | 750 kcmil - #8 str |

Includes:

- Molded Carrying Case
- Instruction Manual
- Specific Control Certification

For Use With

| Aluminum Connectors | Copper Connectors | Visual Identification |
|------------------------------------|--------------------------------|-----------------------|
| Series: ALNS, ALND | Series: CLN4, CLN9, CLND, CLWU | |
| ALNN thru 750kcmil | CLNF, CLNN, CLNS | |
| Series: IACL, 2IACL thru 750kcmil | CLNU, CLWD, CLW4, CLW9 | |
| * Series: 2ACL, 2ACN thru 750kcmil | CLWN, CLWS, CSND | |
| Series: ACL, ACN thru 750kcmil | CSNF, CSNS, CSLT | |
| | CSWD, CSWN, CSW4, CSW9 | |
| Series: *ASN, AS | CT, CTL | |
| CPM Series | | |
| CPML Series | | |
| ACO-90 Series | | |
| ACM Series | | |
| ACO Series | | |
| AH 1-4 | | |
| * HT Series | | |
| | GGA Series | |
| | GGB Series | |
| | ELT Series | |
| | GGC Series | |
| | ULT Series | |
| | RLT Series | |

All wire sizes, unless noted otherwise, are American Wire Gauge (AWG)

* Not UL Listed

J

nVent ILSCO TaskMaster Tools Manual Hydraulic Cutting Tool

TYPE MHCT

Features

- nVent ILSCO TaskMasterPRO five year tool warranty
- Latch head design
- 360° tool head rotation
- 2 stage pump piston
- Lightweight
- Manual hydraulic powered
- Heavy duty blades
- Comfort grips

Benefits

- Ensures confidence for durability & quality
- Secures conductor in place
- Maneuverability
- Rapid advance
- Portability
- No power source required
- Able to cut through hard steel
- Shock absorption

TM-CUT25



| Catalog Number | |
|------------------|----------------------------------------------------|
| TM-CUT25 | TM-6DF1000 |
| BLDF-25HD | Replacement Fixed Blade |
| BLDM-25 | Replacement Moving Blade |
| Specifications | |
| Force Developed | 6.7 tons |
| Weight | 6.4 lbs. |
| Length | 15.5 in |
| Cutting Capacity | |
| Diameter | .98 in |
| CU Conductor | .98 in |
| AL Conductor | .98 in |
| ACSR | 556 kcmil |
| Guy Wire | 9/16 in |
| Guy Wire (EHS) | 9/16 in |
| Ground Rod | 5/8 in |
| Rebar | #5 (5/8 in) Grade 40 For Grade 60, Consult Factory |

TM-CUT45



| Catalog Number | |
|------------------|--------------------------|
| TM-CUT45 | TM-6DF1000 |
| BLDF-45 | Replacement Fixed Blade |
| BLDM-45 | Replacement Moving Blade |
| Specifications | |
| Force Developed | 6.7 tons |
| Weight | 12.5 lbs. |
| Length | 23.6 in |
| Cutting Capacity | |
| Diameter | 1.77 in |
| CU Conductor | 1.5 in |
| AL Conductor | 1.7 in |
| ACSR | 1590 |
| Guy Wire | 5/8 in |
| Guy Wire (EHS) | 1/2 in |
| Ground Rod | 5/8 in |
| Rebar | #4 (1/2 in) Grade 60 |

Includes:

- Molded Carrying Case
- Instruction Manual
- Specific Control Certification

J

nVent ILSCO TaskMaster Tools Manual Hydraulic Cutting Tool

RoHS
Compliant

TYPE MHCT

Features

- nVent ILSCO TaskMasterPRO five year tool warranty
- Latch head design
- 360° tool head rotation
- 2 stage pump piston
- Lightweight
- Manual hydraulic powered
- Comfort grips

Benefits

- Ensures confidence for durability & quality
- Secures conductor in place
- Maneuverability
- Rapid advance
- Portability
- No power source required
- Shock absorption

TM-CUT50CU



Catalog Number

| | |
|------------|--------------------------|
| TM-CUT50CU | TM-6DF1000 |
| BLDF-50 | Replacement Fixed Blade |
| BLDM-50 | Replacement Moving Blade |

Specifications

| | |
|-----------------|-----------|
| Force Developed | 6.7 tons |
| Weight | 11.3 lbs. |
| Length | 24 in |

Cutting Capacity

| | |
|--------------|---------|
| Diameter | 1.96 in |
| CU Conductor | 1.9 in |
| AL Conductor | 1.9 in |

TM-CUT85CU

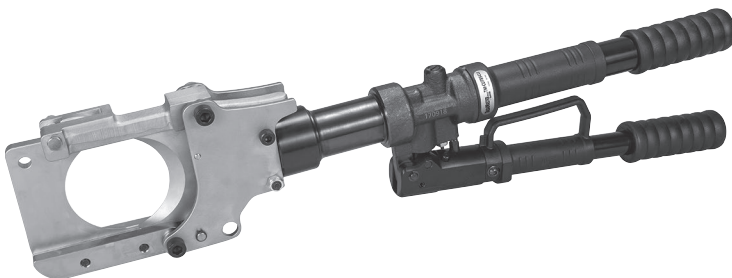

Catalog Number

| | |
|------------|--------------------------|
| TM-CUT85CU | TM-6DF1000 |
| BLDF-85 | Replacement Fixed Blade |
| BLDM-85 | Replacement Moving Blade |

Specifications

| | |
|-----------------|-----------|
| Force Developed | 7.8 tons |
| Weight | 16.1 lbs. |
| Length | 27.4 in |

Cutting Capacity

| | |
|--------------|---------|
| Diameter | 3.34 in |
| CU Conductor | 3.3 in |
| AL Conductor | 3.3 in |

Includes:

- Molded Carrying Case
- Instruction Manual
- Specific Control Certification

DO NOT CUT:

ACSR Cable, Steel, Ground Rod, Rebar or Guy Wire

nVent ILSCO TaskMaster Tools Remote Hydraulic Dieless Crimping Head

RoHS
Compliant

TYPE
HRTI

Features

- nVent ILSCO TaskMasterPRO five year tool warranty
- Remote hydraulic powered
- Operates with 10,000 p.s.i. pump
- Quick connect male attachment point
- Dieless crimping operation
- Flip top head

Benefits

- Ensures confidence for durability & quality
- Ease of use
- Industry standard
- Time saving leak free connection
- Versatility, works on large range of wire sizes
- Easy connector loading and unloading

TR-6DF1000

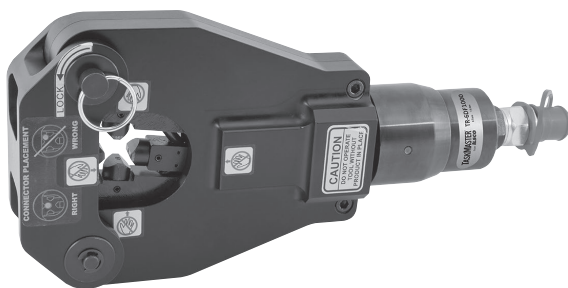

| Catalog Number | |
|-----------------|-------------------------|
| TR-6DF1000 | |
| Specifications | |
| Force Developed | 6 tons |
| Weight | 7.8 lbs. |
| Length | 12 in |
| Head Opening | 1.55 in |
| Crimp Range | Lugs & Splices |
| CU Conductor | 1000 kcmil - #8 sol/str |
| AL Conductor | 750 kcmil - #8 str |

Includes:

- Durable Carrying Bag
- Instruction Manual

J

nVent ILSCO TaskMaster Tools Remote Hydraulic Crimping Head

RoHS
Compliant

TYPE
HRTI

Features

- nVent ILSCO TaskMasterPRO five year tool warranty
- Remote hydraulic powered
- Operates with 10,000 p.s.i. pump
- Accepts U-type dies
- Quick connect male attachment point

Benefits

- Ensures confidence for durability & quality
- Ease of use
- Industry standard
- Flexibility in the field
- Time saving leak free connection

TR-12U1000



| Catalog Number | |
|-----------------|-------------------------|
| TR-12U1000 | |
| Specifications | |
| Force Developed | 14.6 tons |
| Weight | 9.7 lbs. |
| Length | 10.6 in |
| Jaw Opening | 1.65 in |
| Crimp Range | Lugs & Splices |
| CU Conductor | 1000 kcmil - #8 sol/str |
| AL Conductor | 750 kcmil - #8 str |

Includes:

- Molded Carrying Case
- Instruction Manual

For Use With

| Aluminum Connectors | Copper Connectors | Visual Identification |
|------------------------------------|--------------------------------|-----------------------|
| Series: ALNS, ALND | Series: CLN4, CLN9, CLND, CLWU | |
| ALNN thru 750kcmil | CLNF, CLNN, CLNS | |
| Series: IACL, 2IACL thru 750kcmil | CLNU, CLWD, CLW4, CLW9 | |
| * Series: 2ACL, 2ACN thru 750kcmil | CLWN, CLWS, CSND | |
| Series: ACL, ACN thru 750kcmil | CSNF, CSNS, CSLT | |
| | CSWD, CSWN, CSWS, CSW4, CSW9 | |
| Series: *ASN, AS | CT, CTL | |
| CPM Series | | |
| CPML Series | | |
| ACO-90 Series | | |
| ACM Series | | |
| ACO Series | | |
| AH 1-4 | | |
| * HT Series | | |
| | GGA Series | |
| | GGB Series | |
| | ELT Series | |
| | GGC Series | |
| | ULT Series | |
| | RLT Series | |

All wire sizes, unless noted otherwise, are American Wire Gauge (AWG)

* Not UL Listed

J

nVent ILSCO TaskMaster Tools Remote Hydraulic Cutting Head

TYPE HRCT

Features

- nVent ILSCO TaskMasterPRO five year tool warranty
- Remote hydraulic powered
- Operates with 10,000 p.s.i. pump
- Latch head design
- Quick connect male attachment point
- Heavy duty blades

Benefits

- Ensures confidence for durability & quality
- Ease of use
- Industry standard
- Secures conductor in place
- Time saving leak free connection
- Able to cut through hard steel

TR-CUT25



| Catalog Number | |
|------------------|----------------------------------------------------|
| TR-CUT25 | |
| BLDF-25HD | Replacement Fixed Blade |
| BDM-25 | Replacement Moving Blade |
| Specifications | |
| Force Developed | 6.7 tons |
| Weight | 4.6 lbs. |
| Length | 8.6 in |
| Cutting Capacity | |
| Diameter | .98 in |
| CU Conductor | .98 in |
| AL Conductor | .98 in |
| ACSR | 556 kcmil |
| Guy Wire | 9/16 in |
| Guy Wire (EHS) | 9/16 in |
| Ground Rod | 5/8 in |
| Rebar | #5 (5/8 in) Grade 40 For Grade 60, Consult Factory |

TR-CUT45



| Catalog Number | |
|------------------|--------------------------|
| TR-CUT45 | |
| BLDF-45 | Replacement Fixed Blade |
| BDM-45 | Replacement Moving Blade |
| Specifications | |
| Force Developed | 6.7 tons |
| Weight | 6.4 lbs. |
| Length | 12.3 in |
| Cutting Capacity | |
| Diameter | 1.77 in |
| CU Conductor | 1.5 in |
| AL Conductor | 1.7 in |
| ACSR | 1590 |
| Guy Wire | 5/8 in |
| Guy Wire (EHS) | 1/2 in |
| Ground Rod | 5/8 in |
| Rebar | #4 (1/2 in) Grade 60 |

Includes:

- Durable Carrying Pouch with Clip
- Instruction Manual



nVent ILSCO TaskMaster Tools Remote Hydraulic Cutting Head

RoHS
Compliant

TYPE
HRCT

Features

- nVent ILSCO TaskMasterPRO five year tool warranty
- Remote hydraulic powered
- Operates with 10,000 p.s.i. pump
- Latch head design
- Quick connect male attachment point

Benefits

- Ensures confidence for durability & quality
- Ease of use
- Industry standard
- Secures conductor in place
- Time saving leak free connection

TR-CUT50CU



Catalog Number

| | |
|------------|--------------------------|
| TR-CUT50CU | |
| BLDF-50 | Replacement Fixed Blade |
| BLDM-50 | Replacement Moving Blade |

Specifications

| | |
|-----------------|----------|
| Force Developed | 6.7 tons |
| Weight | 6.4 lbs. |
| Length | 12.3 in |

Cutting Capacity

| | |
|--------------|---------|
| Diameter | 1.96 in |
| CU Conductor | 1.9 in |
| AL Conductor | 1.9 in |

TR-CUT85CU

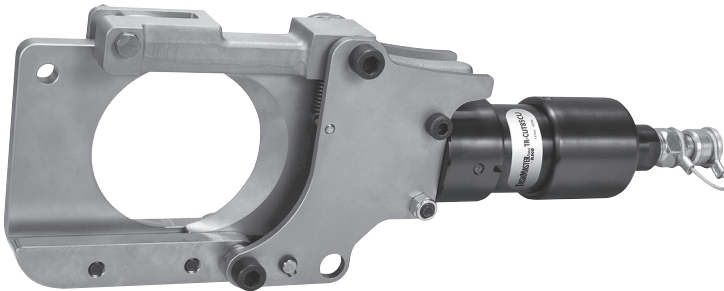

Catalog Number

| | |
|------------|--------------------------|
| TR-CUT85CU | |
| BLDF-85 | Replacement Fixed Blade |
| BLDM-85 | Replacement Moving Blade |

Specifications

| | |
|-----------------|----------|
| Force Developed | 7.8 tons |
| Weight | 8.8 lbs. |
| Length | 15.3 in |

Cutting Capacity

| | |
|--------------|---------|
| Diameter | 3.34 in |
| CU Conductor | 3.3 in |
| AL Conductor | 3.3 in |

TR-CUT120CU



Catalog Number

| | |
|-------------|--------------------------|
| TR-CUT120CU | |
| BLDF-120 | Replacement Fixed Blade |
| BLDM-120 | Replacement Moving Blade |

Specifications

| | |
|-----------------|-----------|
| Force Developed | 15 tons |
| Weight | 17.8 lbs. |
| Length | 21 in |

Cutting Capacity

| | |
|--------------|---------|
| Diameter | 4.72 in |
| CU Conductor | 4.5 in |
| AL Conductor | 4.5 in |

DO NOT CUT:

ACSR Cable, Steel, Ground Rod, Rebar or Guy Wire

Includes:

- Durable Carrying Pouch with Clip
- Instruction Manual

J

nVent ILSCO TaskMaster Tools Remote Head Hydraulic Cutting Tools

RoHS
Compliant

TYPE HRCT

Features

- nVent ILSCO TaskMasterPRO five year tool warranty
- Remote hydraulic powered
- Operates with 10,000 p.s.i. pump
- Scissor head design
- Quick connect male attachment point

Benefits

- Ensures confidence for durability & quality
- Ease of use
- Industry standard
- One handed operation
- Time saving leak free connection

TR-CUT65CUS



Catalog Number

| | |
|-------------|----------------------------|
| TR-CUT65CUS | |
| BLDS-65 | Replacement Blade Assembly |
| BLDG-65 | Replacement Blade Guide |

Specifications

| | |
|-----------------|-----------|
| Force Developed | 4.9 tons |
| Weight | 10.3 lbs. |
| Length | 14.5 in |

Cutting Capacity

| | |
|--------------|------------|
| Diameter | 2.5 in |
| CU Conductor | 1000 kcmil |
| AL Conductor | 2.5 in |

TR-CUT95CUS



Catalog Number

| | |
|-------------|----------------------------|
| TR-CUT95CUS | |
| BLDS-95 | Replacement Blade Assembly |
| BLDG-95 | Replacement Blade Guide |

Specifications

| | |
|-----------------|-----------|
| Force Developed | 7.3 tons |
| Weight | 15.2 lbs. |
| Length | 18.3 in |

Cutting Capacity

| | |
|--------------|------------|
| Diameter | 3.75 in |
| CU Conductor | 1000 kcmil |
| AL Conductor | 3.5 in |

TR-CUT120CUS



Catalog Number

| | |
|--------------|---------------------------|
| TR-CUT120CUS | |
| BLDS-120 | Replacement Blade Assembl |
| BLDM-120 | Replacement Moving Blade |

Specifications

| | |
|-----------------|-----------|
| Force Developed | 6.7 tons |
| Weight | 16.5 lbs. |
| Length | 19.8 in |

Cutting Capacity

| | |
|--------------|------------|
| Diameter | 4.75 in |
| CU Conductor | 1000 kcmil |
| AL Conductor | 4.5 in |

DO NOT CUT:
ACSR Cable, Steel, Ground Rod, Rebar or Guy Wire

Includes:

- Durable Plastic Carrying Case
- Instruction Manual

J

nVent ILSCO TaskMaster Tools Battery Powered Hydraulic Pump



TYPE
HPI

Features

- nVent ILSCO TaskMasterPRO five year tool warranty
- 18 V, 5.0 Ah Milwaukee Li-ion battery, 3 year warranty
- Auto cut detection
- USB interface
- Light weight/Compact design
- LED operating indicator lights
- LED battery charge indicator
- Manual release switch
- Quick disconnect couplers
- Closed oil system
- Digital display screen

Benefits

- Ensures confidence for durability & quality
- Eliminates need for external power source
- Extends motor life
- Capture data for performance, reporting & service
- Reduces fatigue & saves space
- Identifies condition and readiness of pump
- Job site battery management
- Emergency safety release, even without battery
- Leak free connection
- Allows pump to function, even upside down
- Visual control and verification of retract time



* See nVent ILSCO TaskMaster Tool Accessories page for alternate hoses, foot operated remote, and replacement parts

Catalog Number

| | |
|--------|----------|
| TB-PMP | Pump Kit |
|--------|----------|

Specifications

| | |
|-------------------------|------------|
| Force Developed | 10,000 psi |
| Compression Head Max | 60 ton |
| Hose Length | 5 ft. |
| Weight with 5.0 Battery | 11.4 lbs |
| Oil Capacity | 25 oz. |

Battery Life Estimates

Number of Cycles

| | |
|-----------------|-----|
| 18V DC - 5.0 Ah | 250 |
|-----------------|-----|

Kit Includes:

- Pump
- 2 Milwaukee Batteries - 18V 5.0 Ah
- 1 Milwaukee Battery Charger - 120V AC
- 5 ft. Non-conductive Filled Hose
- 5 ft. Hand Held Remote Pump Cord
- Shoulder Strap for Pump
- USB 2.0 Cable Type A to Mini-B, 6 ft.
- Durable Carrying Bag
- Instruction Manual
- Male/Female Adapters
- Specific Control Certification

J

nVent ILSCO TaskMaster Battery Powered Hydraulic Pump

RoHS
Compliant

TYPE
HPI

Features

- nVent ILSCO TaskMasterPRO five year tool warranty
- 18 V, 5.0 Ah Milwaukee • Li-ion battery, 3 year warranty
- Auto cut detection
- USB interface
- Light weight/Compact design
- LED operating indicator lights
- LED battery charge indicator
- Manual release switch
- Quick disconnect couplers
- Return adjustment knob
- Closed oil system
- Digital display screen
- Data capture for performance, reporting and service
- Customizable nominal pressure & cycle time

Benefits

- Ensures confidence for durability & quality
- Eliminates need for external power source
- Extends motor life
- Capture data for performance, reporting & service
- Reduces fatigue & saves space
- Identifies condition and readiness of pump
- Job site battery management
- Emergency safety release, even without battery
- Leak free connection
- Faster crimp cycles
- Allows pump to function, even upside down
- Visual control and verification of retract time
- Save specific settings for quick access to multiple, different applications



TB-PMP-PRO



Catalog Number

| | |
|-------------|----------------------------------------|
| TB-PMP-PRO | Pump Pro Kit |
| TB-PMP-PROX | Pump Pro Kit w/o batteries and charger |

Specifications

| | |
|-------------------------|------------|
| Force Developed | 10,000 psi |
| Compression Head Max | 60 ton |
| Hose Length | 5 ft. |
| Weight with 5.0 Battery | 11.4 lbs |
| Oil Capacity | 25 oz. |

Battery Life Estimates

Number of Cycles

| | |
|-----------------|-----|
| 18V DC - 5.0 Ah | 250 |
|-----------------|-----|

* See tool accessories page for alternate hoses, foot operated remote and replacement parts.

Kit Includes:

- Pump
- 2 Milwaukee' Battery Charger - 120V AC
- 1 Milwaukee' Batteries - 18V 5.0 Ah
- 5 ft. Non-conductive Filled Hose
- 5 ft. Hand Held Remote Pump Cord
- Shoulder Strap for Pump
- USB 2.0 Cable Type A to Mini-B, 6 ft.
- Durable Carrying Bag
- Instruction Manual
- Male/Female Adapters
- Specific Control Certification

J

nVent ILSCO TaskMaster Tools Foot Powered Pump

RoHS
Compliant

TYPE
HPI

Features

- nVent ILSCO TaskMasterPRO five year tool warranty
- Manual retract switch
- 2 stage pump cylinder
- Includes coupling adapters
- Quick connect female attachment point
- Foot powered hydraulic

Benefits

- Ensures confidence for durability & quality
- Retract head at any time
- Rapid advance
- Ensure industry standard hose connection
- Time saving leak free connection
- No outside power source required

TMFT-PMP

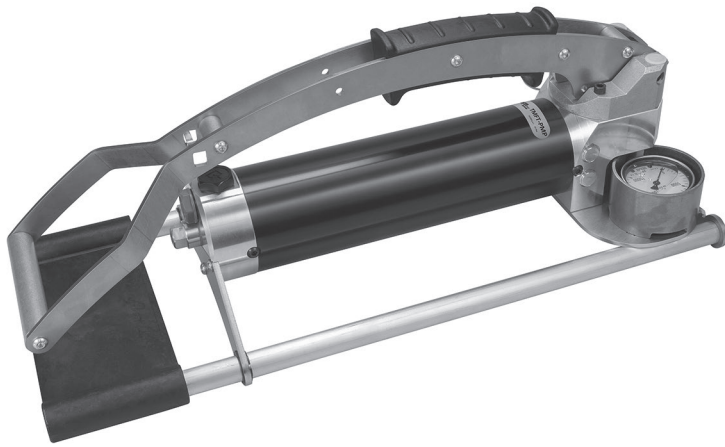

* Hoses sold separately see nVent ILSCO TaskMaster Tool Accessories Page

Catalog Number

| | |
|----------|------|
| TMFT-PMP | Pump |
|----------|------|

Specifications

| | |
|----------------------|------------|
| Force Developed | 10,000 psi |
| Compression Head Max | 60 ton |
| Pump Length | 22.4 in |
| Weight | 21 lbs. |
| Length | 14.5 in |

Includes:

- Pump
- Durable Metal Case
- Instruction Manual
- Male and Female quick connect adapters
- Specific Control Certification

J

TYPE
HPI

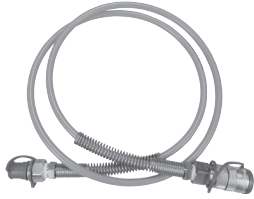

Fig. 1



Fig. 2



Fig. 3



Fig. 4



Fig. 5



Fig. 6



Fig. 7



Fig. 8



Fig. 9



Fig. 10

| Figure Number | Catalog Number | Description |
|---------------|--------------------|-----------------------------------|
| Fig. 1 | HSO-5 | 5 ft. Non-conductive filled hose |
| Fig. 1 | HSO-10 | 10 ft. Non-conductive filled hose |
| Fig. 1 | HSO-15 | 15 ft. Non-conductive filled hose |
| Fig. 1 | HSO-30 | 30 ft. Non-conductive filled hose |
| Fig. 2 | HSA-5 | 5 ft. Armored filled hose |
| Fig. 2 | HSA-10 | 10 ft. Armored filled hose |
| Fig. 2 | HSA-15 | 15 ft. Armored filled hose |
| Fig. 2 | HSA-30 | 30 ft. Armored filled hose |
| Fig. 3 | CH-12V | 12V Battery charger |
| Fig. 4 | RCPMP-5 | 5 ft. Hand held remote pump cord |
| - | SHST | Shoulder strap for pump |
| - | USB | 6 ft. 2.0 Cable Type A to Mini-B |
| Fig. 5 | QCA-M | Male adapter |
| Fig. 6 | QCA-F | Female adapter |
| Fig. 7 | U-W-BAG | Bag In-line |
| Fig. 8 | FP-PMP | Foot pedal for TB-PMP |
| Fig. 9 | INLINE-CASE | Molded Case |
| Fig. 9 | PISTOLGRIP-CASE-L | Molded Case |
| Fig. 10 | PISTOLGRIP-CASE-XL | Molded Case |

TYPE
ILD-KIT-CU
ILD-KIT-AL
ILD-KIT-PG

Features

- ILD-KIT-CU is for use with SureCrimp copper connectors
- ILD-KIT-AL is for use with SureCrimp aluminum connectors
- ILD-KIT-PG is for use with PermaGround connectors

| Wire Size | ILD-KIT-CU Includes | ILD-KIT-AL Includes |
|-----------|---------------------|---------------------|
| #6 | ILD-24-1 | ILD-346 |
| #4-3 | ILD-29-1 | ILD-375 |
| #2 | ILD-33 | ILD-348 |
| #1 | ILD-37 | ILD-471 |
| 1/0 | ILD-42 | ILD-296 |
| 2/0 | ILD-45 | ILD-297 |
| 3/0 | ILD-50 | ILD-467 |
| 4/0 | ILD-54 | ILD-298 |
| 250kcmil | ILD-62 | ILD-324 |
| 300kcmil | ILD-66 | ILD-470 |
| 350kcmil | ILD-71 | ILD-299 |
| 400kcmil | ILD-76 | ILD-472 |
| 500kcmil | ILD-87 | ILD-300 |
| 600kcmil | ILD-94 | ILD-473 |
| 750kcmil | ILD-106 | ILD-936 |



ILD-KIT-CU
ILD-KIT-AL

ILD-KIT-PG Includes

ILD-C
ILD-D3
ILD-O
ILD-997
ILD-998
ILD-1011
ILD-BG
ILD-238
ILD-162
ILD-PRECRIMP

All Die Kits are in a Pelican case (UDIE-CASE)



ILD-KIT-PG

Compression Dies for Aluminum Connectors



Compressor Dies For ILC-12-N, ILC-12H-N, ILCB-12 Series (Hydraulic Tools)
TB-12U1000-P, TM-12U1000, TR-12U1000

| Catalog Number | Die Color Code | Connector Series ALNS, ALND, ALNN Wire Size |
|----------------|----------------|---------------------------------------------|
| ILD-374 | Blue | #8 |
| ILD-346 | Gray | #6 |
| ILD-375 | Green | #4 |
| ILD-348 | Pink | #2 |
| ILD-471 | Gold | #1 |
| ILD-296 | Tan | 1/0 |
| ILD-297 | Olive | 2/0 |
| ILD-467 | Ruby | 3/0 |
| ILD-298 | White | 4/0 |
| ILD-324 | Red | 250kcmil |
| ILD-470 | Blue | 300kcmil |
| ILD-299 | Brown | 350kcmil |
| ILD-472 | Green | 400kcmil |
| ILD-300 | Pink | 500kcmil |
| ILD-473 | Black | 600kcmil |
| ILD-936 | Yellow | 700/750kcmil |



Compressor Dies For ILC-12, ILC-12-N, ILC-12H, ILC-12H-N, ILCB-12, ILCB-12-N, ILCB-12-LIQ, ILC-14, ILC-14H,
ILC-15, ILC-15H, ILC-750, TB-12U1000-P, TM-12U1000, TR-12U1000

| Catalog Number | Die Color Code | Fine Strand Copper Wire Only |
|----------------|-----------------------------|------------------------------|
| | Series CS, CL, CT, CTL, F2C | Series CS, CL, CT, CTL, F2C |
| ILD-21 | 8 AWG | 8 FLEX CLASS G,H,I,K,M,DLO |
| ILD-24-1 | 6 AWG, 5 AWG | 6 FLEX CLASS G,H,I,K,M,DLO |
| ILD-29-1 | 4-3 AWG | 4 FLEX CLASS G,H,I,K,M,DLO |
| ILD-33 | 2 AWG | - |
| ILD-37 | 1 AWG | 2 FLEX CLASS G,H,I,K,M,DLO |
| ILD-42 | 1/0 AWG | 1 FLEX CLASS G,H,I,K,M,DLO |
| ILD-45 | 2/0 AWG | 1/0 FLEX CLASS G,H,I,K,M,DLO |
| ILD-50 | 3/0 AWG | 2/0 FLEX CLASS G,H,I,K,M,DLO |
| ILD-54 | 4/0 AWG | 3/0 FLEX CLASS G,H,I,K,M,DLO |
| ILD-62 | 250kcmil | 4/0 FLEX CLASS G,H,I,K,M,DLO |
| ILD-66 | 300kcmil | 250 G,H |
| ILD-71 | 350kcmil | 250 I,K,M, 262 DLO |
| ILD-76 | 400kcmil | 300 G,H,I,K,M, 313 DLO |
| ILD-87 | 500kcmil | 350 G,H,I,K,M, 373 DLO |
| ILD-94 | 600kcmil | 400 G,H,I,K,M, 444 DLO |
| ILD-99 | 700kcmil | 500 G,H,I,K,M, 535 DLO |
| ILD-106 | 750kcmil | 600 G,H,I,M, 646 DLO |
| ILD-125 | 1000kcmil | 750 G,H,I, 777 DLO |





Compressor Dies For ILC-12-N, ILC-12H-N, ILCB-12-N, ILC-15H, ILC-12, ILC-12H, ILC-14, ILC-14H, ILCB-12, ILCB-12-LIO, ILC-15, ILC-750, TB-12U1000-P, TM-12U1000, TR-12U1000

| Catalog Number | Wire Size | | |
|----------------|---------------------------------------|------------------------------|------------------------------|
| | Legacy Aluminum Terminals and Splices | ACM and ACO Pin Connectors | CPM Pin Connectors |
| ILD-2 | 8 | | |
| ILD-3 | 6 | | |
| ILD-4 | 4 | | |
| ILD-5 | | | |
| ILD-6 | | | |
| ILD-7 | 2, 1 | | |
| ILD-8 | 1/0 | 6, 4, 2, 1 | |
| ILD-9 | 6, 4, 2, 1 | | |
| ILD-10 | 2/0, 3/0 | | |
| ILD-11 | | | |
| ILD-12 | 4/0 | 1/0, 2/0, 3/0, 4/0 | 1/0, 2/0, 3/0, 4/0 |
| ILD-13 | 250kcmil | | |
| ILD-14 | 300kcmil, 350kcmil | 250kcmil, 300kcmil, 350kcmil | 250kcmil, 300kcmil, 350kcmil |
| ILD-15 | | | |
| ILD-16 | 400kcmil | | |
| ILD-16A | *500kcmil | 400kcmil, 500kcmil | 400kcmil, 500kcmil |
| ILD-17 | *600kcmil, *700kcmil | | |
| ILD-18 | *700kcmil | 600kcmil, 750kcmil | 600 kcmil, 750kcmil |
| ILD-P302+ | ‡1000kcmil | | |

* Cannot be used on Sleeves with ILC-12-N, ILC-12H-N, ILC-12 and ILC-12H tools

‡ For use on ALNN-1000-12-134

* For use with ILC-15 or ILC-15H, must be used with ILC-PADP when using ILC-15H

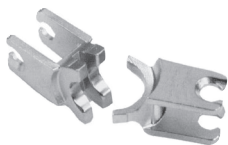

Type W Dies For ND-60, ND-58, TB-6WBG500-I, TB-6WO500-I, TB-6WD3500-I

| Catalog Number | For Use With | |
|----------------|------------------------------------------------------------|------------------------------------------------------------------------------------|
| | Aluminum Compression Connectors | Copper Compression Connectors |
| ND-O | HT-1, HT-2, AH-1 | GGC-1 (nVent ERICO), GGA-1 (nVent ERICO), GGA-2 (nVent ERICO), GGA-4 (nVent ERICO) |
| ND-BG | PICS-61 thru PICS-78 | ULT-4, ULT-5 |
| ND-C | | ULT-6, ULT-7 |
| ND-K-840 | UCS-2/0, UCS-3/0, UCS-4/0, UCS-250, PICS-834 thru PICS-869 | |

J

FOR TYPE
ILC-15
ILC-15H
ILC-750

Features



Figure 1

Benefits

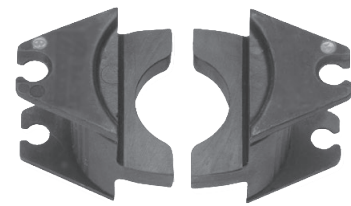

Figure 2

| Catalog Number | Figure Number | For Use With | |
|----------------|---------------|---------------------------------------------------------------|------------------------------------------------------------------------------------------------------------------------------------------------|
| | | Aluminum Compression | Copper Compression Connectors |
| ILD-K-840*+ | 1 | UCS-2/0, UCS-3/0, UCS-4/0, UCS-250, PICS-834 through PICS-869 | |
| ILD-C*+ | 1 | | ULT-6-Z, ULT-7-Z, ELT-1 (all nVent ERICO) |
| ILD-D3*+ | 1 | HT-2, HT-3, HT-4, HT-5, HT-7, AH-2, AH-3, AH-4 | ULT-10-Z, ULT-11-Z, ULT-12-Z, CDT-308-8, CDT-307-8 (all nVent ERICO) |
| ILD-O* | 1 | HT-1, HT-6, HT-8, AH-1 | GGC-1, GGA-1, GGA-2, GGA-4, ELT-2, ELT-4, CDT-304-8, CDT-303-8, ULT-8-Z, ULT-9-Z (all nVent ERICO) |
| ILD-N*+ | 1 | AH-5, AH-6, AH-7 | |
| ILD-KR+ | 2 | AH-8, AH-9, AH-10, AH-11, AH-12 | AH-10, AH-11, AH-12 |
| ILD-997*+ | 1 | | GGA-2, GGA-3, GGA-4, GGA-5, GGC-2, GGC-3, GGC-4, ELT-3, ELT-5, CGP2-2250, CGP4-2250 (all nVent ERICO); GGA-9 |
| ILD-998+ | 1 | | GGA-4, GGA-5, GGC-5, GGC-6, GGC-7, GGC-9, CGP4-250500, RLT-4TN, RLT-7TN, RLT-2 through RLT-13 (all nVent ERICO); CGP2-250500, RLT-8TN, RLT-9TN |
| ILD-P998o | 2 | Can only be used with ILC-15 or ILC-15H | GGA-4, GGA-5, GGB-1 thru GGB-8, GGC-5, GGC-6, GGC-7, (all nVent ERICO); RLT |
| ILD-P999o | 2 | Can only be used with ILC-15 or ILC-15H | GGA-6, GGC-8 (all nVent ERICO) |
| ILD-1011+ | 1 | | GGA-6, GGC-8, ELT-6, ELT-7, ELT-8, RLT-4TN, RLT-7TN, RLT-2 through RLT-13 (all nVent ERICO); RLT-8TN, RLT-9TN |
| ILD-P1011o | 2 | Can only be used with ILC-15 or ILC-15H | GGA-6, GGC-8 (all nVent ERICO); RLT |
| ILD-BG | 1 | PICS-61 thru PICS-78 | ULT-3-Z, ULT-4-Z, ULT-5-Z, CST-301, CST-302, CDT-399-8, CDT-398-8 (all nVent ERICO) |
| ILD-P302o | 1 | ALNN, Can only be used with ILC-15 or ILC-15H | |
| ILD-238 | - | | ULT-1-Z (nVent ERICO) |
| ILD-162 | - | | ULT-2-Z (nVent ERICO) |
| ILD-Precrimp | - | | 1/2, 5/8, 3/4, Ground Rod Pre Crimp Die |

* May also be used with ILC-12-N, ILC-12H-N, ILCB-12-N, ILC-12, ILC-12H, ILCB-12
 + Must be used with ILDPADP when using ILC-15, must be used with ILDPADP when using ILC-15H
 o Must be used with ILDPADP when using ILC-15H

Die Adaptors

FOR TYPE
ILC-15
ILC-15H



Figure 1

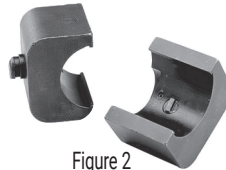

Figure 2

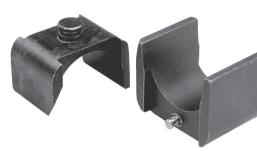

Figure 3

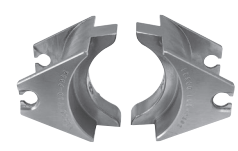

Figure 4

| Catalog Number | Figure Number | Description | Die Color Code |
|----------------|---------------|----------------------------------------------------------------------------------------------------------------|----------------|
| ILD-ADP | 1 | Permits ILDPADP Series to be inserted in ILC-15 or ILC-15H tool, if using ILC-15H ILDPADP must be used as well | |
| ILD-UADP | 2 | Permits ILDPADP Series to be inserted in ILC-15 or ILC-15H tool | |
| ILD-PADP | 3 | Permits "P" style dies to be inserted in ILC-15H tool | |
| ILD-P302 | 4 | 1000kcmil, ILDPADP die adaptor must be used | Brown |

nVent ILSCO Dino Dies

#8 – 1000 kcmil Copper and Aluminum

TYPE
ILD-SSP
ILD-LSP
ILD-NSP

Features

- Dies sold in a complete kit or as individual components
- Innovative and patented nVent ILSCO design
- Crimp up to 1000 kcmil connectors using the 12 ton die-taking crimp tool
- Dies are made out of hardened stainless steel

Benefits

- No need to purchase separate adapters or an additional tool to crimp complete range of sizes
- Durable construction produces a secure electrical connection on every crimp
- Replaces a standard set of over 30 U-dies
- Save time swapping between die sets on the job
- Produce cUL listed crimps with connections made with the Dino Dies, nVent ILSCO tool, and nVent ILSCO connector
- SureCrimp Guaranteed warranty when crimping with complete nVent ILSCO system



ILD-LSP



ILD-SSP

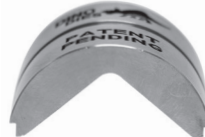

ILD-NSP

| Catalog Number | Description | Aluminum Wire Range | Copper Wire Range | Use with these nVent ILSCO TaskMaster Tools |
|----------------|-------------------------|--------------------------------|--------------------------------|-----------------------------------------------------|
| ILD-DINOKIT | Dino Die Complete Kit | #8 solid/stranded - 1000 kcmil | #8 solid/stranded - 1000 kcmil | TB-12U1000-P, TB-12U1000-PX, TR-12U1000, TM-12U1000 |
| ILD-SSP* | Small Dino Die #8 - 750 | #8 solid/stranded - 750 kcmil | #8 solid/stranded - 750 kcmil | |
| ILD-LSP* | Large Dino Die | 2/0 - 1000 kcmil | 250 - 1000 kcmil | |
| ILD-NSP | Common Seating Dino Die | — | — | |

* The large and small dino dies cannot be used by themselves. They must be used in combination with the common seating die ILD-NSP. The indenter die (ILD-SSP or ILD-LSP) should always be inserted on the ram side of the tool head when doing a crimp.

1 YEAR LIMITED WARRANTY

Crimp from #8 to 1000 kcmil copper & aluminum
WITH JUST A SINGLE SET OF 3 DIES!

✓
#8 LUG



✓
1000 KCMIL LUG



SureCrimp System Guarantee – 10 year warranty

- Connections made with:
nVent ILSCO TaskMaster tool, nVent ILSCO die, and SureCrimp lug
- Includes over 5000 SureCrimp part numbers (CS, CL, CT, ASN, ALNN, ALNS, ALND)



W-Dies

#8 – 500 kcmil Die Sets

TYPE ILD-W

- Dies sold separately or in copper and aluminum kits
- W-Dies fit into the D-3 nest of the nVent ILSCO in-line 6 ton crimping tool
- Dies are made out of hardened stainless steel
- Industry-leading compliance testing with nVent ILSCO and other brand's lugs
- Durable construction produces a secure electrical connection on every crimp
- Flexibility, compatibility, and UL compliance with other brands
- Produce cUL listed crimps with connections made with the W-Dies, nVent ILSCO tool, and nVent ILSCO connectors
- SureCrimp Guaranteed warranty when crimping with complete nVent ILSCO system



ILD-W24



ILD-W42



ILD-W66

| Catalog Number | Description | Use with these nVent ILSCO TaskMaster tools |
|----------------|-------------------------------------|---------------------------------------------|
| ILD-W21 | Copper #8 W-Die Pair | TB-6WO500-I |
| ILD-W24 | Copper #6 W-Die Pair | TB-6WBG500-I |
| ILD-W29 | Copper #4 W-Die Pair | TB-6WD3500-I |
| ILD-W33 | Copper #2 W-Die Pair | TB-6WO500-IX |
| ILD-W37 | Copper #1 W-Die Pair | TB-6WBG500-IX |
| ILD-W42 | Copper 1/0 W-Die Pair | TB-6WD3500-IX |
| ILD-W45 | Copper 2/0 W-Die Pair | |
| ILD-W50 | Copper 3/0 W-Die Pair | |
| ILD-W54 | Copper 4/0 W-Die Pair | |
| ILD-W62 | Copper 250 W-Die Pair | |
| ILD-W66 | Copper 300 W-Die Pair | |
| ILD-W71 | Copper 350 W-Die Pair | |
| ILD-W76 | Copper 400 W-Die Pair | |
| ILD-W87 | Copper 500 W-Die Pair | |
| ILD-KIT-WCU | Copper W Die Kit - #8 - 500 kcmil | |
| ILD-W374 | Aluminum #8 W-Die Pair | |
| ILD-W346 | Aluminum #6 W-Die Pair | |
| ILD-W375 | Aluminum #4 W-Die Pair | |
| ILD-W348 | Aluminum #2 W-Die Pair | |
| ILD-W471 | Aluminum #1 W-Die Pair | |
| ILD-W296 | Aluminum 1/0 W-Die Pair | |
| ILD-W297 | Aluminum 2/0 W-Die Pair | |
| ILD-W467 | Aluminum 3/0 W-Die Pair | |
| ILD-W298 | Aluminum 4/0 W-Die Pair | |
| ILD-W324 | Aluminum 250 W-Die Pair | |
| ILD-W470 | Aluminum 300 W-Die Pair | |
| ILD-W299 | Aluminum 350 W-Die Pair | |
| ILD-KIT-WAL | Aluminum W Die Kit - #8 - 350 kcmil | |

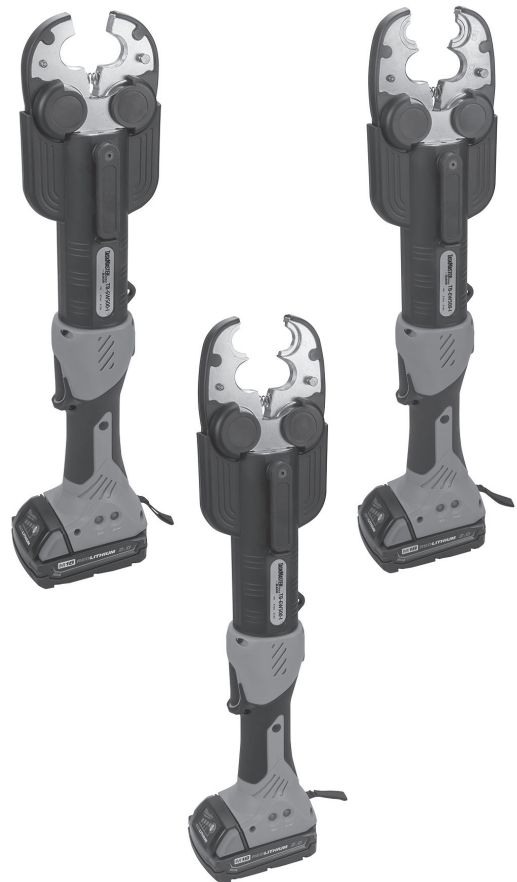

► Consult full nVent ILSCO catalog for complete W-Die listing

Manually Operated Compression Tool

RoHS
Compliant

TYPE MT-25

Features

- Dieless single indent compressor
- Steel adjusting knob
- UL Listed terminals and splices
- Broad wire range
- Mounting hole for bench mounting applications

Benefits

- Reduces installed cost by having no separate dies to purchase, change or lose
- Provides fast and easy setting. Simply align the line on the die nest with the wire size gauge for proper crimping results.
- Ensures reliability. nVent ILSCO's standard line of connectors are UL Listed when crimped with the MT-25 tool
- Convenience

Specifications

| | |
|------------------|---------------------------|
| Length: | 22.65 in |
| Weight: | 6 lbs. |
| Depth: | 4.86 in |
| Width: | 1.12 in |
| Conductor Range: | 4/0-8 AL 250kcmil-8 CU |



MT-25

For Use With

| Aluminum Connectors | Copper Connectors |
|-------------------------|--------------------|
| ACL, ACN 4/0-8 | CLN4, CLN9, CLND, |
| 2ACL, 2ACN 4/0-8 | CLNF, CLNN, CLNS, |
| AS 4/0-8 | CLNU, CLW4, CLW9, |
| Series: ALNS, ALND, ASN | CLWD, CLWF, CLWN, |
| ALNN thru 4/0 | CLWS, CSN4, CSN9, |
| | CSND, CSNF, CSNN, |
| | CSNS, CSW4, CSW9, |
| | CSWD, CSWF, CSWN, |
| | CSWS thru 250kcmil |
| | CCL, CRAM |

All wire sizes, unless noted otherwise, are American Wire Gauge (AWG)

J

Manually Operated Compression Tool

RoHS
Compliant

TYPE ND-58

Features

- ① High strength, butting, forged steel jaw
- ② Two permanent die grooves
- ③ Large diameter hardened steel bolts
- ④ Spring loaded positive lock die retainer buttons
- ⑤ Orange alignment grooves
- ⑥ PTFE impregnated steel backed bronze bushings
- ⑦ Over center cam action
- ⑧ Adjustment screws
- ⑨ Handle butt stops and heat shrink tubing
- ⑩ High quality clear hickory handles
- ⑪ Bent handles and anti-slip handle grips

Benefits

- Assures proper crimps
- No additional dies required for "0" and "D3" size tap connectors. The "D3" groove accommodates the complete line of type "W" die inserts.
- Provides increased strength and greater bearing area
- Allows fast, easy, one-hand die insertion. No lost dies.
- Allows easy visual field check for proper tool adjustment
- Over 90,000 crimps provided with Teflon impregnated steel backed bronze bushings
- Assures full crimp force
- Easy tool adjustment with allen wrench screws
- Operator protection provided with butt stops and heat shrink tubing
- Long life expectancy provided with select clear hickory handles and light weight high strength aluminum alloy castings
- Easier tool operation is provided with bent handles and anti-slip grips

Specifications
Crimp Force: 9,000 lbs.
Length: 25-3/8 in
Weight: 9 lbs.

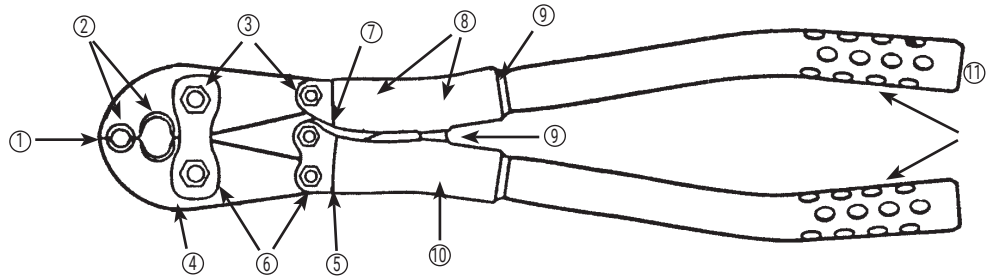

For Use With

| Aluminum Connectors | Copper Connectors |
|---------------------|---------------------|
| PICS Series | GGA-1 (nVent ERICO) |
| P840 Series | GGC-1 (nVent ERICO) |
| UCL 1/0-4 | |
| UCS 1/0-4 | |
| HT Series | |
| AH 1-4 | |

J

Manually Operated Compression Tool

RoHS
Compliant

TYPE ND-60

Features

- ① High strength, butting, forged steel jaw
- ② Two permanent die grooves
- ③ Large diameter hardened steel bolts
- ④ Spring loaded positive lock die retainer buttons
- ⑤ Orange alignment grooves
- ⑥ PTFE impregnated steel backed bronze bushings
- ⑦ Over center cam action
- ⑧ Adjustment screws
- ⑨ Handle butt stops and heat shrink tubing
- ⑩ High quality clear hickory handles
- ⑪ Bent handles and anti-slip handle grips

Benefits

- Assures proper crimps
- No additional dies required for "BG" and "D3" size tap connectors. The "D3" groove accommodates the complete line of type "W-" die inserts.
- Provides increased strength and greater bearing area
- Allows fast, easy, one-hand die insertion. No lost dies.
- Allows easy visual field check for proper tool adjustment
- Over 90,000 crimps provided with Teflon impregnated steel backed bronze bushings
- Assures full crimp force
- Easy tool adjustment with allen wrench screws
- Operator protection provided with butt stops and heat shrink tubing
- Long life expectancy provided with select clear hickory handles and light weight high strength aluminum alloy castings
- Easier tool operation is provided with bent handles and anti-slip grips

Specifications
Crimp Force: 9,000 lbs.
Length: 25-3/8 in
Weight: 9 lbs.

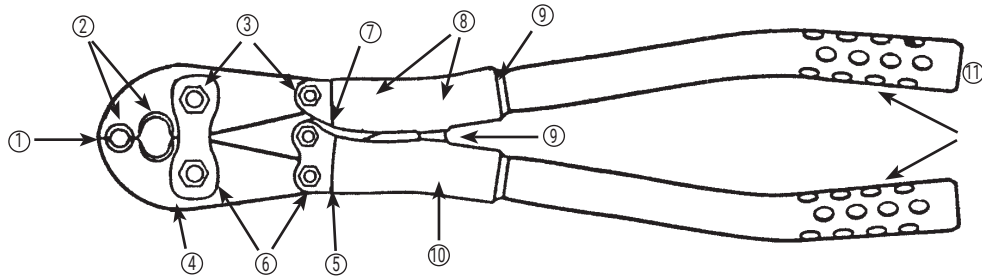

ND-60

For Use With

| Aluminum Connectors | Copper Connectors |
|---------------------|---------------------|
| PICS Series | GGA-1 (nVent ERICO) |
| P840 Series | GGC-1 (nVent ERICO) |
| UCL 1/0-4 | |
| UCS 1/0-4 | |
| HT Series | |
| AH 1-4 | |

J

Manually Operated Compression Tool

RoHS
Compliant

TYPE 94285

Features

- ① Controlled cycle ratchet mechanism
- ② Built in rotatable dies
- ③ Comfort grip handles
 - UL Listed terminals and splices

Benefits

- Acts as a quality control device, once a crimp is started, the tool will not open until it is completed. (Tool has emergency release mechanism.)
- No separate dies to purchase or lose
- Helps ease fatigue with continuous use
- Ensures reliability. nVent ILSCO's standard line of connectors are UL Listed when crimped with the 94285 tool

Specifications

Length: 25-1/4 in
Weight: 6.1 lbs.
Conductor Range: 250kcmil-8 CU
3/0-8 AL

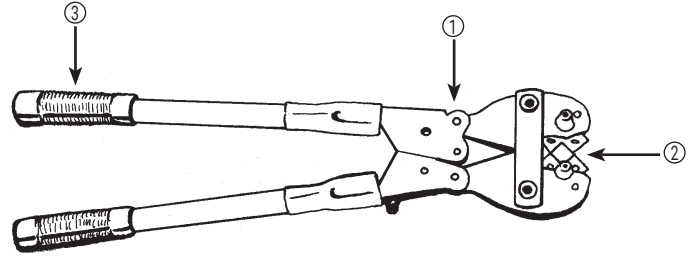

For Use With

| Aluminum Connectors | Copper Connectors |
|--------------------------|------------------------------|
| ACL, ACN 3/0-8 | CLN4, CLN9, CLND, CSLT, CLWU |
| 2ACL, 2ACN 3/0-8 | CLNF, CLNN, CLNS, |
| Series: ALNS, ALND, ASN, | CLNU, CLW4, CLW9, |
| ALNN thru 3/0 | CLWD, CLWF, CLWN, |
| | CLWS, CSN4, CSN9, |
| | CSND, CSNF, CSNN, |
| | CSNS, CSW4, CSW9, |
| | CSWD, CSWF, CSWN, |
| | CSWS thru 250kcmil |

All wire sizes, unless noted otherwise, are American Wire Gauge (AWG)

J

Hand Operated Crimping Tool

RoHS
Compliant

TYPE ILC-10-N

Features

- Rotatable die
- Additional die affixed to frame
- Crimp cavities are color coded to industry standards
- Ratchet control mechanism
- Heat treated frame and dies
- Long, molded handles

Benefits

- Crimps #2, #4, #6 and #8 copper compression connectors
- Crimps 1/0 and #1 copper compression connectors
- Reduces the possibility of improper die selection
- Assures a complete crimp
- Dependable, long lasting tool
- Ergonomic design to reduce hand stress

Specifications

| | |
|------------------|------------|
| Weight: | 1-3/8 lbs. |
| Overall Length: | 11 in |
| Width: | 3.75 in |
| Jaw Opening: | .5 in |
| Conductor Range: | 1/0-8 CU |



ILC-10-N

For Use With

Copper Connectors

CLN4, CLN9, CLND,

CLNF, CLNN, CLNS,

CLNU, CLW4, CLW9,

CLWD, CLWF, CLWN,

CLWS, CSN4, CSN9,

CSND, CSNF, CSNN,

CSNS, CSW4, CSW9,

CSWD, CSWF, CSWN,

CSWS 1/0 thru 8

All wire sizes, unless noted otherwise, are American Wire Gauge (AWG)

TYPE
94130
Controlled-Cycle
Crimper

- Features**
- Dieless tool
 - Ratchet mechanism
 - Compound action
 - Cushion grip handles
 - Crimps insulated wire terminals
 - Wire Range: 10-22 AWG, Weight .8 lb

- Benefits**
- No need to purchase and maintain dies
 - Assures proper crimp force every time
 - Delivers maximum crimp force with minimum effort
 - Provides user comfort
 - Provides flexibility in use



94130

TYPE
94145
Multi Purpose
Crimp Tool

- Features**
- Heavy duty carbon steel construction
 - Comfort grip handles
 - Spring loaded action
 - Safety lock mechanism
 - Color coded crimp nest
 - Crimp nest
 - Wire cutter
 - Machine screw cutters
 - Wire stripper/wire gauge

- Benefits**
- Provides durable rugged reliability
 - Provides user comfort
 - Enables multiple crimps
 - Provides for compact storage
 - For insulated terminals
 - For uninsulated terminals
 - Easily cuts solid and stranded wire
 - Cuts and rethreads 4-40, 6-32, 8-32, 10-24, and 10-32 machine screws
 - 26-8 AWG

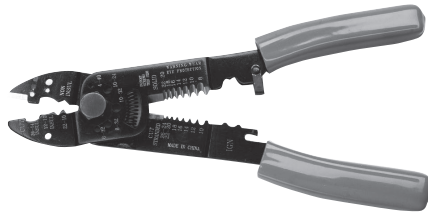

TYPE THT-SC-CC

Features

- Contoured cutting edges
- Stainless steel blades hardened to 55 HRC min
- Heavy duty blades
- Micro-indentations on blades
- Crimps terminals #22-#10 AWG
- Cushion grip on outer surface of handles
- Safety holster with belt clip

Benefits

- Ease of cutting circular shapes
- Provides strength and durability
- Cuts up to #6 AWG and up to 1/0 Flex conductors
- Delivers non-slip cutting
- Multi-purpose
- Adds comfort for challenging cuts
- Portable convenient storage

Specifications

| | |
|-----------------------------|------------------------|
| Length: | 5.875 in |
| Weight: | .12 lbs |
| Cutting CU & AL: | Up to #6 AWG, 1/0 Flex |
| Crimping: | #22-#10 AWG terminals |

Includes:

Safety Holster
Scissors

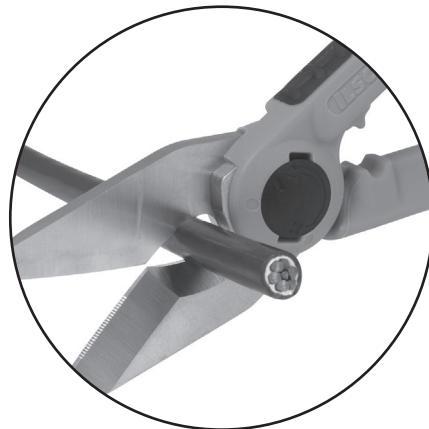

J

THT-SC-CC

nVent ILSCO TaskMaster Tools Knife

TYPE
WSI

Features

- nVent ILSCO TaskMasterPRO five year tool warranty
- Hinged blade guard
- Removeable blade
- Insulated handle

Benefits

- Ensures confidence for durability & quality
- Allows for safe storage and handling
- Easy replacement
- Rated 1000V

THT-K



Catalog Number

| | |
|-------|-------------------|
| THT-K | Knife |
| BLDK | Replacement Blade |

Specifications

| | |
|--------|----------|
| Weight | .12 lbs. |
| Length | 7.25 in |
| Height | 2 in |
| Width | 1.97 in |

nVent ILSCO TaskMaster Tools Stripping Tool

For Removal of Outer Jacket

RoHS
Compliant

TYPE
WSI

Features

- nVent ILSCO TaskMasterPRO five year tool warranty
- Turn click blade adjustment
- Double-sided interchangeable blade
- Traction wheel
- Beveled blade
- Able to be used on end of cable or midspan
- Snap closure mechanism

Benefits

- Ensures confidence for durability & quality
- Provides accurate blade depth without free movement
- Extends life of tool and creates convenience
- Grips outer jacket to make removal easier
- Allows for concentric and lateral cuts
- Allows for additional versatility
- Safe storage

TST-UJ25



AKA The Wheel

Catalog Number

| | |
|------------|-------------------|
| TST-UJ25 | Tool Kit |
| BLDST-UJ25 | Replacement Blade |

Specifications

| | |
|--------|-----------|
| Weight | 0.40 lbs. |
| Length | 6.00 in |
| Height | 2.00 in |
| Width | 1.10 in |

Stripping Capacity

| | |
|-----------------------------|-----------------|
| Min. Cable Diameter | .98 in (25mm) |
| Approximate Min. Cable Size | |
| 15kv | #2 AWG |
| 35kv | #2 AWG |
| 600V | 350 kcmil |
| Insulation Range | 0-.2 in (0-5mm) |

Applicable Layer

Outer Jacket

Kit Includes:

- Stripping tool
- Molded carrying case

J

nVent ILSCO TaskMaster Tools Stripping Tool For Removal of Outer Jacket

RoHS
Compliant

TYPE
WSI

Features

- nVent ILSCO TaskMasterPRO five year tool warranty
- Ultra rigid design
- Turn click blade adjustment
- Double-sided interchangeable blade
- Traction wheel
- Able to be used on end of cable or midspan

Benefits

- Ensures confidence for durability & quality
- Capable of cutting HDPE conduit
- Provides accurate blade depth without free movement
- Extends life of tool and creates convenience
- Grips outer jacket to make removal easier
- Allows for additional versatility

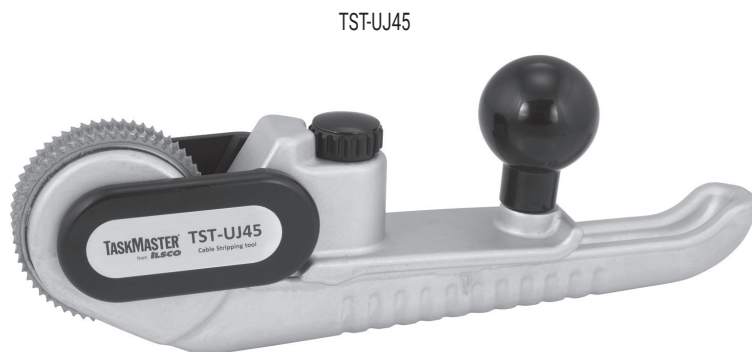

TST-UJ45

AKA The Mega Wheel

| Catalog Number | |
|-----------------------------|-------------------|
| TST-UJ45 | Tool Kit |
| BLDST-UJ45 | Replacement Blade |
| Specifications | |
| Weight | 1.90 lbs. |
| Length | 9.00 in |
| Height | 3.00 in |
| Width | 1.50 in |
| Stripping Capacity | |
| Min. Cable Diameter | 1.77 in (45mm) |
| Approximate Min. Cable Size | |
| 15kv | 750 kcmil |
| 35kv | 350 kcmil |
| Insulation Range | 0-.2 in (0-5mm) |
| Applicable Layer | Outer Jacket |

Kit Includes:

- Stripping tool
- Durable carrying bag

J

nVent ILSCO TaskMaster Tools Stripping Tool

For Removal of Outer Jacket

RoHS
Compliant

TYPE
WSI

Features

- nVent ILSCO TaskMasterPRO five year tool warranty
- Robust design
- Turn click blade adjustment
- Quick release latch
- Built in gripping claw
- Ratcheting drive wheel
- Able to be used on end of cable or midspan

Benefits

- Ensures confidence for durability & quality
- Removes the toughest outer jackets
- Provides accurate blade depth without free movement
- Keeps settings the same while releasing conductor
- Easy removal of difficult jackets
- Ease of lateral cutting
- Allows for additional versatility

TST-CJ54



AKA The Claw

Catalog Number

| | |
|------------|-------------------|
| TST-CJ54 | Tool Kit |
| BLDST-CJ54 | Replacement Blade |

Specifications

| | |
|--------|-----------|
| Weight | 2.50 lbs. |
| Length | 9.00 in |
| Height | 4.00 in |
| Width | 2.50 in |

Stripping Capacity

| | |
|-----------------------------|-----------------|
| Max. Cable Diameter | 2.13 in (54mm) |
| Approximate Max. Cable Size | |
| 15kv | 1000 kcmil |
| 35kv | 750 kcmil |
| 600V | 1500 kcmil |
| Insulation Range | 0-.2 in (0-5mm) |

Applicable Layer

Outer Jacket

Kit Includes:

- Stripping tool
- Hex wrench
- Durable carrying bag

J

nVent ILSCO TaskMaster Tools Stripping Tool For Removal of Outer Jacket

RoHS
Compliant

TYPE
WSI

Features

- nVent ILSCO TaskMasterPRO five year tool warranty
- Closed jaw design
- Spiral adjustment dial
- Turn click blade adjustment
- Compact and lightweight

Benefits

- Ensures confidence for durability & quality
- Allows for a snug hold on conductor
- Provides concentric and varying spiral cuts
- Provides accurate blade depth without free movement
- Ease of use in limited space

TST-CP52



Catalog Number

| | |
|------------|-------------------|
| TST-CP52 | Tool Kit |
| BLDST-CP52 | Replacement Blade |

Specifications

| | |
|--------|-----------|
| Weight | 1.20 lbs. |
| Length | 7.00 in |
| Height | 4.30 in |
| Width | 2.00 in |

Stripping Capacity

| | |
|------------------------|---------------------|
| Min. Cable Diameter | 2.04 in (52 mm) |
| Approximate Cable Size | |
| 15kv | 1000 kcmil |
| 35kv | 1000 kcmil |
| Insulation Range | 0-.578 in (0-15 mm) |

| | |
|------------------|--------------------|
| Applicable Layer | Primary Insulation |
|------------------|--------------------|

Kit Includes:

- Stripping tool
- Allen wrench
- Tube of silicone grease
- Molded carrying case

J

nVent ILSCO TaskMaster Tools Stripping Tool

For Removal of Bonded Semi-Con Layer

RoHS
Compliant

TYPE
WSI

Features

- nVent ILSCO TaskMasterPRO five year tool warranty
- Provides smooth surface on primary insulator
- Removes need for post "cleanup" to remove ridges
- Adjustable handle
- Directional lever
- Turn click blade adjustment
- Semi-con hook
- Blade lock capability
- Able to be used on end of cable or midspan

Benefits

- Ensures confidence for durability & quality
- Reduces corona effect
- Saves time and materials
- Allows tool to be used with right or left hand
- Performs concentric and spiral cuts on semi-con layer
- Provides accurate blade depth without free movement
- Keeps semi-con clear of blade during removal
- Set and forget
- Allows for additional versatility

TST-CBS52

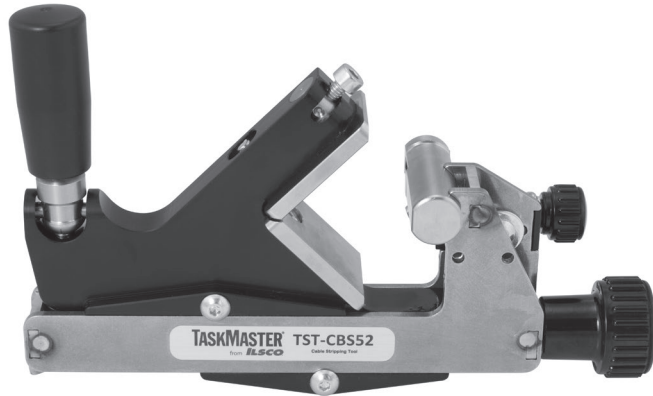

Catalog Number

| | |
|-------------|-------------------|
| TST-CBS52 | Tool Kit |
| BLDST-CBS52 | Replacement Blade |

Specifications

| | |
|--------|-----------|
| Weight | 0.80 lbs. |
| Length | 6.30 in |
| Height | 3.50 in |
| Width | 1.50 in |

Stripping Capacity

| | |
|------------------------|--------------------|
| Max. Cable Diameter | 2.04 in (52 mm) |
| Approximate Cable Size | |
| 15kv | 1000 kcmil |
| 35kv | 1000 kcmil |
| Insulation Range | 0-.59 in (0-15 mm) |

Applicable Layer

Bonded Semi-Con

Kit Includes:

- Stripping tool
- Allen wrench
- Tube of silicone grease
- Molded carrying case

J

nVent ILSCO TaskMaster Tools Scoring Tool For Removal of Non-Bonded Semi-Con Layer

TYPE
WSI

Features

- nVent ILSCO TaskMasterPRO five year tool warranty
- Turn click blade adjustment
- Start clamp
- Blade direction lever
- Compact and light weight
- Scores semi-con layer

Benefits

- Ensures confidence for durability & quality
- Provides accurate blade depth without free movement
- Provides consistency with determined score length and start point
- Allows for lateral, concentric, and spiral scoring
- Ease of use in limited space
- Does not damage primary layer

TST-CNS41



AKA The Scorer

| Catalog Number | |
|-----------------------------|---------------------|
| TST-CNS41 | Tool Kit |
| BLDST-CNS41 | Replacement Blade |
| Specifications | |
| Weight | 0.50 lbs. |
| Length | 5.00 in |
| Height | 3.30 in |
| Width | 2.00 in |
| Stripping Capacity | |
| Max. Cable Diameter | 1.61 in (41mm) |
| Approximate Max. Cable Size | |
| 15kv | 1000 kcmil |
| 35kv | 1000 kcmil |
| Insulation Range | 0-.08 in (0-2mm) |
| Applicable Layer | Non-Bonded Semi-Con |

Kit Includes:

- Scoring tool
- Allen wrench
- Tube of silicone grease
- Start clamp
- Molded carrying case

nVent ILSCO TaskMaster Tools Chamfering Tool

RoHS
Compliant

TYPE
WSI

Features

- nVent ILSCO TaskMasterPRO five year tool warranty
- Teflon coated plates
- Angled blade

Benefits

- Ensures confidence for durability & quality
- Provides optimal sliding on cable without silicone grease
- Allows for quick and easy chamfering of insulation

TST-CC60



Not recommended for penciling

Catalog Number

| | |
|------------|-------------------|
| TST-CC60 | Tool Kit |
| BLDST-CC60 | Replacement Blade |

Specifications

| | |
|--------|-----------|
| Weight | 0.70 lbs. |
| Length | 5.50 in |
| Height | 3.30 in |
| Width | 1.00 in |

Stripping Capacity

| | |
|---------------------|-------------------|
| Max. Cable Diameter | 2.36 in (60mm) |
| Insulation Range | 0-.59 in (0-15mm) |

| | |
|------------------|--------------------|
| Applicable Layer | Primary Insulation |
|------------------|--------------------|

Kit Includes:

- Chamfering tool
- Allen wrench
- Durable carrying bag

J

nVent ILSCO TaskMaster Tools Hand Ratchet Cutter



TYPE CTRI

Features

- nVent ILSCO TaskMasterPRO five year tool warranty
- Patented two-step ratchet mechanism
- Insulated handles
- Lightweight

Benefits

- Ensures confidence for durability & quality
- Requires fewer strokes per cut
- Added safety and shock absorption
- Portability

TRC-CUT750CU



| Catalog Number | |
|--------------------|----------------------------|
| TRC-CUT750CU | Copper and Aluminum Cutter |
| Specifications | |
| Weight | 1.76 lbs. |
| Length | 11.2 in |
| Jaw Opening | 2 in |
| Stripping Capacity | |
| CU Code Wire | 750 kcmil - #8 |
| AL Code Wire | Up to 2 in |

DO NOT CUT: ACSR Cable, Steel, Ground Rod, Rebar or Guy Wire

Includes:

- Cutter
- Instruction Manual

TRC-CUT32ACSR



| Catalog Number | |
|--------------------|-------------|
| TRC-CUT32ACSR | ACSR Cutter |
| Specifications | |
| Weight | 3.36 lbs. |
| Length | 14 in |
| Jaw Opening | 1.25 in |
| Stripping Capacity | |
| ACSR | 477 kcmil |
| Guy Wire | 1/2 in |
| CU, AL Str | 1.25 in |
| CU Sol | 1 in |

DO NOT CUT: EHS Guy Wire

Includes:

- Cutter
- Instruction Manual



TYPE CTR-500

Features

- Sharp precision ground blades
- Moly steel blades
- Durable 20-3/4 in fiberglass handles
- Cuts copper and aluminum cable up to 500kcmil

Benefits

- Provides clean, distortion-free cuts
- Offers extra strength to prevent blade breakage, blades stay sharper longer
- Provides easy handling
- Provides wide cutting range

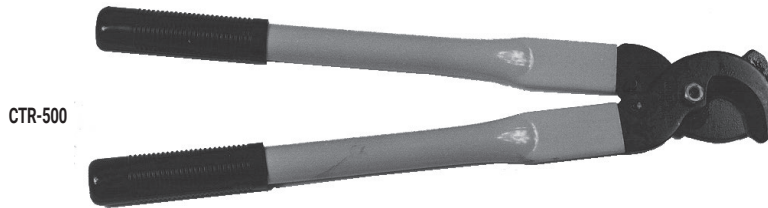

CTR-500

TYPE CTR-750

Features

- Cuts copper and aluminum cable up to 750kcmil
- Lightweight
- Ratchet mechanism
- 16 in length
- Open/close lever
- Alloy steel precision ground replaceable blades

Benefits

- Provides large cutting capacity
- Weight of only 3 lbs. prevents operator fatigue
- Allows large cables to be cut with minimum effort
- Compact size provides ease of use in cramped spaces
- Lever that controls cutting blade direction makes the tool easy to use
- Provides years of service by being able to replace blades when necessary

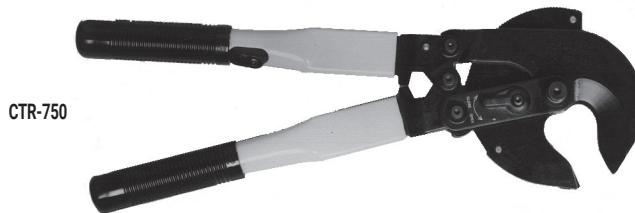

CTR-750

All wire sizes, unless noted otherwise, are American Wire Gauge (AWG)

TYPE MECHANICAL TOOLS



| Catalog Number | Figure Number | Description | Hex Size | Length |
|----------------|---------------|----------------------------------------------------------------------------|------------|--------|
| HW-13 | 2 | Screwdriver Bit for TS-35, .214 x .040 | - | - |
| HW-14 | 2 | Screwdriver Bit for TS-35, .250 x .042 | - | - |
| TK-1 | - | Torque Kit with TS-35, HW-13, HW-14, TW-1, DR-516, DR-38, Case | - | - |
| TK-2 | - | Torque Kit with TS-35, HW-13, HW-14, TW-750R, TW-150R, DR-516, DR-38, Case | - | - |
| TS-35 | 1 | Torque Screwdriver 0-36 lbs. | - | - |
| TW-1 | 3 | Torque Wrench 0-600 in. lbs. | - | - |
| TW-150R | 4 | Torque Wrench (Ratchet type) 5-150 in. lbs. | - | - |
| TW-750R | 4 | Torque Wrench (Ratchet type) 100-750 in. lbs. | - | - |
| WR-1 | 6 | Double Wrench | 3/16, 5/16 | 4 |
| WR-1A | 5 | Wrench | 3/16 | 4-1/2 |
| WR-4 | 5 | Wrench | 5/16 | 3-3/16 |
| WR-9 | 5 | Wrench | 5/16 | 10 |
| WR-10 | 5 | Wrench | 3/8 | 10 |
| WR-12 | 5 | Wrench | 1/2 | 5-1/2 |
| WC | 7 | Wire Brush | - | - |

TYPE
**Electric
Heat Gun**

Features

- Two temperature settings 750F and 1100F
- Three way switch OFF/HI/LO
- Built-in fold down stand
- 1200 Watt 120 V AC
- Heat deflector
- Impact resistant case
- Six foot cord
- Supplied in plastic carrying case

Benefits

- Provides versatility in applying recommended heat, deliverable in seconds
- Aids in producing proper air flow from heat gun
- Provides hands free operation
- Provides high output of air and heat
- Allows for concentration of heat for rapid heat shrink process
- Provides extra durability in harsh environments
- Provides operator convenience
- Provides ease of storage and accessibility



| Catalog Number | Description |
|----------------|------------------------------------------|
| 27001 | Heat Gun, 11 Disks Thin Wall Heat Shrink |
| 94502 | Electric Heat Gun 120v |
| 94504 | Replacement Adaptor for 94502 |

Information Sheet

Series ALNS, ALND, ASNS, ASND, ALNB, ASNB, ALNN, ASNN, and ASN^a
 Compression Connectors for Aluminum or Copper Conductor



Tooling Information

| ILSCO | | | | | | | | | | | | | | | | | | |
|----------------------|-------------------------|------------|--------|----------|--------|--------|----------------------------------------------------------------------------------------------------------------|------------------------------------|----------|----------------|----------|----------------|-----------------------|----------------|-----------------------|----------------|--------|----------------|
| Lug/Splice Size | Wire Size | Color Code | Crimps | Die Code | Crimps | Crimps | IDT-6 ^b , IDT-6H ^b , IDTB-6 ^b series (6-Ton Hydraulic Dieless) | IDT-12-N ^b (Dieless) | Die Code | Crimps | Die Code | Crimps | Die Code | Crimps | Die Code | Crimps | Crimps | Crimps |
| 8 | 8 AWG | Blue | 1 | M,K | 2 | 1 | | | ILD-374 | 1 | ILD-374 | 1 | ILD-374 | 1 | ILD-374 | 1 | 1 | 1 |
| 6 | 6 AWG | Grey | 1 | K,K | 2 | 1 | | | ILD-346 | 1 | ILD-346 | 1 | ILD-346 | 1 | ILD-346 | 1 | 1 | 1 |
| 4 | 4 AWG | Green | 1 | H,H | 3 | 1 | | | ILD-375 | 1 | ILD-375 | 1 | ILD-375 | 1 | ILD-375 | 1 | 1 | 1 |
| 2 | 2 AWG | Pink | 2 | E,A | 3 | 1 | | | ILD-348 | 1 | ILD-348 | 1 | ILD-348 | 1 | ILD-348 | 1 | 2 | 1 ^c |
| 1 | 1 AWG | Gold | 2 | E,A | 3 | 1 | | | ILD-471 | 1 | ILD-471 | 1 | ILD-471 | 1 | ILD-471 | 1 | 2 | 1 ^c |
| 1/0 | 1/0 AWG | Tan | 2 | A,C | 3 | 1 | | | ILD-296 | 1 | ILD-296 | 1 | ILD-296 | 1 | ILD-296 | 1 | 2 | 1 ^c |
| 2/0 | 2/0 AWG | Olive | 2 | A,B | 3 | 1 | | | ILD-297 | 1 ^c | ILD-297 | 1 ^c | ILD-297 | 1 ^c | ILD-297 | 1 ^c | 2 | 2 |
| 3/0 | 3/0 AWG | Ruby | 2 | A,A | 3 | 1 | | | ILD-467 | 1 ^c | ILD-467 | 1 ^c | ILD-467 | 1 ^c | ILD-467 | 1 ^c | 2 | 2 |
| 4/0 | 4/0 AWG | White | 2 | | | 1 | | | ILD-298 | 2 | ILD-298 | 2 | ILD-298 | 2 | ILD-298 | 2 | 2 | 2 |
| 250 | 250 kcmil | Red | | | | 1 | | | ILD-324 | 2 | ILD-324 | 2 | ILD-324 | 2 | ILD-324 | 2 | 2 | 2 |
| 300 | 300 kcmil | Blue | | | | 1 | | | ILD-470 | 2 | ILD-470 | 2 | ILD-470 | 2 | ILD-470 | 2 | 2 | 2 |
| 350 | 350 kcmil | Brown | | | | 1 | | | ILD-299 | 2 | ILD-299 | 2 | ILD-299 | 2 | ILD-299 | 2 | 2 | 2 ^d |
| 400 | 400 kcmil | Green | | | | 1 | | | ILD-472 | 4 | ILD-472 | 4 | ILD-472 | 4 | ILD-472 | 4 | 2 | 2 ^e |
| 500 | 500 kcmil | Pink | | | | 1 | | | ILD-300 | 4 | ILD-300 | 4 | ILD-300 | 4 | ILD-300 | 4 | 2 | 2 ^e |
| 600 | 600 kcmil | Black | | | | 1 | | | ILD-473 | 4 | ILD-473 | 4 | ILD-473 | 4 | ILD-473 | 4 | 2 | 2 ^e |
| 700/750 | 700/750 kcmil | Yellow | | | | 1 | | | ILD-936 | 3 | ILD-936 | 3 | ILD-936 | 3 | ILD-936 | 3 | 2 | 2 ^e |
| 700/750 ⁹ | 900 kcmil Compact Al | Yellow | | | | 1 | | | ILD-936 | 3 | ILD-936 | 3 | ILD-936 | 3 | ILD-936 | 3 | 2 | 2 ^e |
| 1000 | 1000 kcmil | Brown | | | | 1 | | | ILD-936 | 3 | ILD-936 | 3 | ILD-P302 ^h | 3 | ILD-P302 ^h | 3 | | |

Additional Information:

- 1) The ALNS, ALND, ASNS, ASND, ALNB, ASNB, ALNN, ASNN, and ASN connectors are marked with the die numbers and required number of crimps for ILSCO hydraulic tools.
- 2) When using other listed tools, consult chart for crimps required. Crimps should be evenly space on connector.
- 2) Consult manufacturers data for catalog numbers of dies for each tool.

- ^a Number of crimps shown on chart must be applied to both sides of ASN splice connector's centerline.
- ^b Dieless tools are not color coded and do not require dies.
- ^c For ASN splicer connector, apply 2 crimps on both sides of splice connector's centerline.
- ^d For ASN splicer connector, apply 3 crimps on both sides of splice connector's centerline.
- ^e For ASN splicer connector, apply 4 crimps on both sides of splice connector's centerline.
- ⁹ 700/750 size lug/splice are additionally rated for use with 900 kcmil compact aluminum wire.
- ^h The die index of ILD-P302 is 302.

Connector Installation

1. Select proper connector for the wire size to be used. Series can be used with concentric, compressed or compact aluminum or copper wire.
2. Strip wire insulation using an approved method. Do not nick or ring the wire. Remove any major coating on the wire.
3. Remove surface oxides from the wire with a wire brush.
4. Insert wire all the way into the barrel of the connector.
5. Select the proper die for approved tool. See chart above for approved tools and dies. Compress barrel from tang toward wire, or from inside of ASN connector towards wire.
6. When terminating an aluminum connector to a steel or copper stud, use a Belleville or compression type washer in combination with a flat washer. Tighten until the Belleville washer is flat.

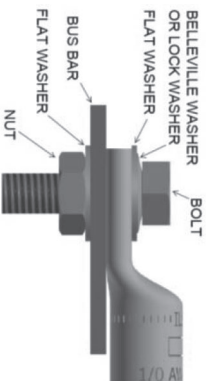

Information Sheet

Series ALNS, ALND, ASNS, ASND, ALNB, ASNB, ALNN, ASNN, and ASNA
Compression Connectors for Aluminum or Copper Conductor



Tooling Information

| Lug/Splice Size | Y500CTHS, PAT600 | | BURNDY | | THOMAS AND BETTS | | GREENLEE | | ANDERSON | | RIDGID | | UTILCO | |
|----------------------|------------------|----------------|----------|--------|------------------|--------|-----------------------|----------------|-----------------------|----------------|-----------------------|----------------|-----------------------|----------------|
| | Die Code | Crimps | Die Code | Crimps | Die Code | Crimps | Die Code | Crimps | Die Code | Crimps | Die Code | Crimps | Die Code | Crimps |
| 8 | X8CART | 1 | U8CABT | 1 | U8CABT | 1 | ILD-374 | 1 | ILD-374 | 1 | ILD-374 | 1 | ILD-374 | 1 |
| 6 | W161 | 1 | U6CABT | 1 | U6CABT | 1 | ILD-346 | 1 | ILD-346 | 1 | ILD-346 | 1 | ILD-346 | 1 |
| 4 | W162 | 2 | U4CABT | 1 | U4CABT | 1 | ILD-375 | 1 | ILD-375 | 1 | ILD-375 | 1 | ILD-375 | 1 |
| 2 | W239 | 2 | U2CABT | 1 | U2CABT | 1 | ILD-348 | 1 | ILD-348 | 1 | ILD-348 | 1 | ILD-348 | 1 |
| 1 | W163 | 2 | U1CABT | 1 | U1CABT | 1 | ILD-471 | 1 | ILD-471 | 1 | ILD-471 | 1 | ILD-471 | 1 |
| 1/0 | W241 | 2 | U2SART | 1 | U2SART | 1 | ILD-296 | 1 | ILD-296 | 1 | ILD-296 | 1 | ILD-296 | 1 |
| 2/0 | W245 | 2 | U2SART | 2 | U2SART | 2 | ILD-297 | 1 ^c | ILD-297 | 1 ^c | ILD-297 | 1 ^c | ILD-297 | 1 ^c |
| 3/0 | W186 | 2 | U27ART | 2 | U27ART | 2 | ILD-467 | 1 ^c | ILD-467 | 1 ^c | ILD-467 | 1 ^c | ILD-467 | 1 ^c |
| 4/0 | W660 | 2 | U28ART | 2 | U28ART | 2 | ILD-298 | 2 | ILD-298 | 2 | ILD-298 | 2 | ILD-298 | 2 |
| 250 | | 2 | U29ART | 2 | U29ART | 2 | ILD-324 | 2 | ILD-324 | 2 | ILD-324 | 2 | ILD-324 | 2 |
| 300 | | 2 | U30ART | 2 | U30ART | 2 | ILD-470 | 2 | ILD-470 | 2 | ILD-470 | 2 | ILD-470 | 2 |
| 350 | W31ART | 3 | U31ART | 2 | U31ART | 2 | ILD-299 | 2 | ILD-299 | 2 | ILD-299 | 2 | ILD-299 | 2 |
| 400 | | 2 ^a | U32ART | 4 | U32ART | 4 | ILD-472 | 4 | ILD-472 | 4 | ILD-472 | 4 | ILD-472 | 4 |
| 500 | | 2 ^a | U34ART | 4 | U34ART | 4 | ILD-300 | 4 | ILD-300 | 4 | ILD-300 | 4 | ILD-300 | 4 |
| 600 | | 2 ^a | U36ART | 4 | U36ART | 4 | ILD-473 | 4 | ILD-473 | 4 | ILD-473 | 4 | ILD-473 | 4 |
| 700/750 | | 2 ^a | U39ART | 4 | U39ART | 4 | ILD-936 | 3 | ILD-936 | 3 | ILD-936 | 3 | ILD-936 | 3 |
| 700/750 ^b | | | | | | | ILD-936 | 3 | ILD-936 | 3 | ILD-936 | 3 | ILD-936 | 3 |
| 1000 | | | | | P44ART | 4 | ILD-P302 ^k | 3 | ILD-P302 ^k | 3 | ILD-P302 ^k | 3 | ILD-P302 ^k | 3 |

Additional Information:

- The ALNS, ALND, ASNS, ASND, ALNB, ASNB, ALNN, ASNN, and ASNA connectors are marked with the die numbers and required number of crimps for ILSCO hydraulic tools. When using other listed tools, consult chart for crimps required. Crimps should be evenly spaced on connector.
 - Consult manufacturers data for catalog numbers of dies for each tool.
- ^a Number of crimps shown on chart must be applied to both sides of ASN splice connector's centerline.
- ^b Dieless tools are not color coded and do not require dies.
- ^c For ASN splice connector, apply 2 crimps on both sides of splice connector's centerline.
- ^d For ASN splice connector, apply 3 crimps on both sides of splice connector's centerline.
- ^e For ASN splice connector, apply 4 crimps on both sides of splice connector's centerline.

Connector Installation

- Select proper connector for the wire size to be used. Series can be used with concentric, compressed or compact aluminum or copper wire.
- Strip wire insulation using an approved method. Do not nick or ring the wire. Remove any major coating on the wire.
- Remove surface oxides from the wire with a wire brush.
- Insert wire all the way into the barrel of the connector.
- Select the proper die for approved tool. See chart above for approved tools and dies. Compress barrel from tang toward wire, or from inside of ASN connector towards wire.
- When terminating an aluminum connector to a steel or copper stud, use a Belleville or compression type washer in combination with a flat washer. Tighten until the Belleville washer is flat.

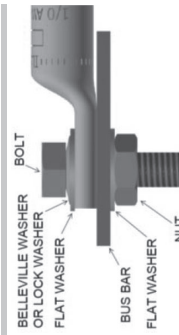

Information Sheet

Series ALNS, ALND, ASNS, ASND, ALNB, ASNB, ALNN, ASNN, and ASN^a

Compression Connectors for Aluminum or Copper Conductor



Range Taking (for ILSCO, BURNDY, GREENLEE, RIDGID and UTILCO Dieless Tools)

| Lug/Splice Size | Standard Wire Size | Expanded Wire Range | ILSCO | | BURNDY | | GREENLEE | | RIDGID | | UTILCO | |
|-----------------|--------------------|------------------------|--------------------|---------------------|----------------------------|------------------------------------------|---------------------------------------------------------------------------------------|-----------------------------------------------------------------------------------------------|---------------------------|-----------------------------------------------------------------|-------------------|-------------------------------------------------------------------------|
| | | | MT-25 ^b | IVTB-6 ^b | IDTB-6 ^b series | IDT-6 ^b , IDT-6H ^b | TM-6DF-1000 ^b , TR-6DF-1000 ^b , TB-6DF-1000 ^b series | PAT4PC834 ^b , PAT81KFT ^b , Y81KFT ^b , Y81KFTMBH ^b | BURNDY Y644M ^b | EK06FT ^b , HK06FT ^b , RK06FT ^b | RE 6 ^b | UM-4PT ^b , UR-4PT ^b , BLL-4PT ^b series |
| 4 | 4 AWG | 4 - 6 AWG | 1 | 1 | 1 | 1 | 1 | 1 | 1 | 1 | 1 | 1 |
| 2 | 2 AWG | 2 - 6 AWG | 2 | 2 | 1 | 1 ^c | 1 | 1 | 2 | 2 | 1 ^c | 1 ^c |
| 1 | 1 AWG | 1 - 2 AWG | 2 | 2 | 1 | 1 ^c | 1 ^c | 1 | 2 | 2 | 1 ^c | 1 ^c |
| 1/0 | 1/0 AWG | 1/0 - 1 AWG | 2 | 2 | 1 | 1 ^c | 1 ^c | 1 | 2 | 2 | 1 ^c | 1 ^c |
| 2/0 | 2/0 AWG | 2/0 - 1 AWG | 2 | 2 | 2 | 2 | 2 | 2 | 2 | 2 | 2 | 2 |
| 3/0 | 3/0 AWG | 3/0 - 1 AWG | 2 | 2 | 2 | 2 | 2 | 2 | 2 | 2 | 2 | 2 |
| 4/0 | 4/0 AWG | 4/0 - 1 AWG | 2 | 2 | 2 | 2 | 2 | 2 | 2 | 2 | 2 | 2 |
| 250 | 250 kcmil | 250 kcmil - 1/0 AWG | | 2 | 2 | 2 | 2 | 2 | 2 | 2 | 2 | 2 |
| 300 | 300 kcmil | 300 kcmil - 2/0 AWG | | 2 | 2 | 2 | 2 | 2 | 2 | 2 | 2 | 2 |
| 350 | 350 kcmil | 350 kcmil - 3/0 AWG | | 2 | 2 | 2 ^d | 2 ^d | 2 | 2 | 2 | 2 | 2 ^d |
| 400 | 400 kcmil | 400 kcmil - 4/0 AWG | | 2 | 2 | 2 ^e | 2 ^e | 2 | 2 | 2 | 2 | 2 ^e |
| 500 | 500 kcmil | 500 kcmil - 4/0 AWG | | 2 | 2 ^e | 2 ^e | 2 ^e | 2 ^e | 2 | 2 | 2 | 2 ^e |
| 600 | 600 kcmil | 600 kcmil - 250 kcmil | | | 2 ^e | 2 ^e | 2 ^e | 2 ^e | | | | 2 ^e |
| 700/750 | 700/750 kcmil | 750 kcmil - 500 kcmil | | | 2 ^e | 2 ^e | 2 ^e | 2 ^e | | | | 2 ^e |
| 1000 | 1000 kcmil | 1000 kcmil - 750 kcmil | | | | 2 ^e | 2 ^e | 2 ^e | | | 1 ^f | 2 ^e |

^a Number of crimps shown on chart must be applied to both sides of ASN splice connector's centerline.
^b Dieless tools are not color coded and do not require dies.
^c For ASN splicer connectors, apply 2 crimps on both sides of splice connector's centerline.
^d For ASN splicer connectors, apply 3 crimps on both sides of splice connector's centerline.
^e For ASN splicer connectors, apply 4 crimps on both sides of splice connector's centerline.
^f ASN-1000 splicer connector is NOT UL listed or CSA certificated with Y644M dieless tools.

Series CT and CTL

Compression Connectors for Fine Strand Copper Wire Only (CU9)

WARNING! Do Not Use With Aluminum Wire



| Lug Size | Wire Size | Copper Code | Die Index | Manual Hand Tools | | ILSCO TOOLS | | Hydraulic Tools | | WELDING | | LOCATIVE | | T&B TOOLS | | GREENLEE TOOLS | | RBDIG TOOLS | | UTLCO TOOLS | | Lug Size |
|----------|-----------|-------------|-----------|-------------------|-----------|-------------|---------|-----------------|---------|----------|---------|----------|---------|-----------|---------|----------------|---------|-------------|---------|-------------|---------|----------|
| | | | | Left Die | Right Die | # Crimps | Index # | # Crimps | Battery | # Crimps | Battery | # Crimps | Battery | # Crimps | Battery | # Crimps | Battery | # Crimps | Battery | # Crimps | Battery | |
| 8 *** | 8 | Red | 21 | M | K | 2 | 2 | 1 | 1 | 1 | 1 | 1 | 1 | 1 | 1 | 1 | 1 | 1 | 1 | 1 | 1 | 8 |
| 3 ** | 4 | White | 20 | K | K | 2 | 2 | 1 | 1 | 1 | 1 | 1 | 1 | 1 | 1 | 1 | 1 | 1 | 1 | 1 | 1 | 3 ** |
| 2 ** | 4 | White | 20 | K | K | 2 | 2 | 1 | 1 | 1 | 1 | 1 | 1 | 1 | 1 | 1 | 1 | 1 | 1 | 1 | 1 | 2 ** |
| 1 ** | 2 | Green | 37 | H | H | 2 | 2 | 1 | 1 | 1 | 1 | 1 | 1 | 1 | 1 | 1 | 1 | 1 | 1 | 1 | 1 | 1/0 ** |
| 2/0 ** | 1/0 | Black | 42 | H | H | 2 | 2 | 1 | 1 | 1 | 1 | 1 | 1 | 1 | 1 | 1 | 1 | 1 | 1 | 1 | 1 | 1/0 ** |
| 3/0 ** | 1/0 | Black | 45 | E | A | 3 | 3 | 1 | 1 | 1 | 1 | 1 | 1 | 1 | 1 | 1 | 1 | 1 | 1 | 1 | 1 | 2/0 ** |
| 4/0 ** | 3/0 | Yellow | 54 | A | B | 3 | 3 | 1 | 1 | 1 | 1 | 1 | 1 | 1 | 1 | 1 | 1 | 1 | 1 | 1 | 1 | 3/0 ** |
| 250 ** | 4/0 | Yellow | 62 | A | B | 3 | 3 | 1 | 1 | 1 | 1 | 1 | 1 | 1 | 1 | 1 | 1 | 1 | 1 | 1 | 1 | 4/0 ** |
| 300 ** | 250 | White | 66 | A | B | 3 | 3 | 1 | 1 | 1 | 1 | 1 | 1 | 1 | 1 | 1 | 1 | 1 | 1 | 1 | 1 | 250 ** |
| 350 ** | 250 | Red | 71 | | | 2 | 2 | 1 | 1 | 1 | 1 | 1 | 1 | 1 | 1 | 1 | 1 | 1 | 1 | 1 | 1 | 350 ** |
| 400 ** | 300 | Black | 76 | | | 2 | 2 | 1 | 1 | 1 | 1 | 1 | 1 | 1 | 1 | 1 | 1 | 1 | 1 | 1 | 1 | 400 ** |
| 450 ** | 300 | Black | 80 | | | 2 | 2 | 1 | 1 | 1 | 1 | 1 | 1 | 1 | 1 | 1 | 1 | 1 | 1 | 1 | 1 | 450 ** |
| 500 ** | 400 | Green | 94 | | | 2 | 2 | 1 | 1 | 1 | 1 | 1 | 1 | 1 | 1 | 1 | 1 | 1 | 1 | 1 | 1 | 500 ** |
| 600 | 500 | Pink | 99 | | | 2 | 2 | 1 | 1 | 1 | 1 | 1 | 1 | 1 | 1 | 1 | 1 | 1 | 1 | 1 | 1 | 600 |
| 700 | 500 | Pink | 99 | | | 2 | 2 | 1 | 1 | 1 | 1 | 1 | 1 | 1 | 1 | 1 | 1 | 1 | 1 | 1 | 1 | 700 |
| 750 | 600 | Black | 106 | | | 3 | 3 | 1 | 1 | 1 | 1 | 1 | 1 | 1 | 1 | 1 | 1 | 1 | 1 | 1 | 1 | 600 |
| 1000 | 750 | White | 125 | | | 3 | 3 | 1 | 1 | 1 | 1 | 1 | 1 | 1 | 1 | 1 | 1 | 1 | 1 | 1 | 1 | 750 |

** See note below

| Lug Size | AWG | STR | C | | G | | H | | I | | K | | M | | DLO | |
|----------|------|-----|------|-----|-----|-----|-----|-----|-----|------|-----|------|-------|-------|-------|-------|
| | | | AWG | STR | AWG | STR | AWG | STR | AWG | STR | AWG | STR | AWG | STR | AWG | STR |
| 8 | 8 | 7 | 8 | 19 | 8 | 49 | 8 | 133 | 8 | 41 | 8 | 68 | 8 | 420 | 8 | 37 |
| 4 | 4 | 7 | 4 | 19 | 6 | 49 | 6 | 133 | 6 | 63 | 6 | 269 | 6 | 8 | 6 | 61 |
| 3 | 3 | 7 | 3 | 19 | 4 | 49 | 4 | 133 | 4 | 105 | 4 | 420 | 4 | 1064 | 4 | 105 |
| 2 | 2 | 7 | 2 | 19 | 4 | 49 | 4 | 133 | 4 | 105 | 4 | 420 | 4 | 1064 | 4 | 105 |
| 1 | 1 | 19 | 1 | 19 | 2 | 49 | 2 | 133 | 2 | 181 | 2 | 865 | 2 | 1866 | 2 | 150 |
| 1/0 | 1/0 | 19 | 1/0 | 19 | 2 | 49 | 2 | 133 | 2 | 210 | 2 | 2107 | 2 | 2107 | 2 | 225 |
| 2/0 | 2/0 | 19 | 2/0 | 19 | 2 | 49 | 2 | 133 | 2 | 210 | 2 | 2107 | 2 | 2107 | 2 | 225 |
| 3/0 | 3/0 | 19 | 3/0 | 19 | 2 | 49 | 2 | 133 | 2 | 210 | 2 | 2107 | 2 | 2107 | 2 | 225 |
| 4/0 | 4/0 | 19 | 4/0 | 19 | 2 | 49 | 2 | 133 | 2 | 210 | 2 | 2107 | 2 | 2107 | 2 | 225 |
| 250 | 250 | 37 | 250 | 37 | 3/0 | 259 | 3/0 | 418 | 3/0 | 418 | 3/0 | 1666 | 3/0 | 4256 | 3/0 | 450 |
| 300 | 300 | 37 | 300 | 37 | 4/0 | 259 | 4/0 | 532 | 4/0 | 532 | 4/0 | 2107 | 4/0 | 5320 | 4/0 | 532 |
| 350 | 350 | 37 | 350 | 37 | 4/0 | 259 | 4/0 | 532 | 4/0 | 532 | 4/0 | 2107 | 4/0 | 5320 | 4/0 | 532 |
| 400 | 400 | 37 | 400 | 37 | 4/0 | 259 | 4/0 | 532 | 4/0 | 532 | 4/0 | 2107 | 4/0 | 5320 | 4/0 | 532 |
| 500 | 500 | 37 | 500 | 37 | 3/0 | 259 | 3/0 | 427 | 3/0 | 882 | 3/0 | 3458 | 3/0 | 8806 | 3/0 | 3727 |
| 600 | 600 | 61 | 600 | 61 | 4/0 | 259 | 4/0 | 477 | 4/0 | 880 | 4/0 | 3960 | 4/0 | 10101 | 4/0 | 444 |
| 650 | 600 | 61 | 600 | 61 | 5/0 | 259 | 5/0 | 427 | 5/0 | 1225 | 5/0 | 5054 | 5/0 | 12891 | 5/0 | 535.3 |
| 700 | 700 | 61 | 700 | 61 | 5/0 | 259 | 5/0 | 427 | 5/0 | 1225 | 5/0 | 5054 | 5/0 | 12891 | 5/0 | 535.3 |
| 750 | 750 | 61 | 700 | 61 | 5/0 | 259 | 5/0 | 427 | 5/0 | 1225 | 5/0 | 5054 | 5/0 | 12891 | 5/0 | 535.3 |
| 1000 | 1000 | 61 | 1000 | 61 | 750 | 427 | 750 | 703 | 750 | 1470 | 750 | 610 | 14245 | 750 | 14245 | 750 |

UL Listed and CSA Certified when installed with tools and dies shown above

- Number of crimps shown on chart must be on each end of the CT splicer connectors.
- The CT connectors are marked with color, the die numbers and required number of crimps for ILSCO hydraulic tools. When using other listed tools, consult chart for crimps required. Crimps should be evenly spaced on connector.
- The ILSCO 94-265, MT-25 and all cables tools are not color coded or do not contain the die index.
- Consult manufacturers data for catalog numbers of dies for each tool.
- Strip Length = Barrel Length * (1/18 inch)
- For long barrel CTLU connectors add one additional crimp to each side of barrel.

Information Sheet

Series CS, CL Compression Connectors

for Class B/C Copper Wire Only (CU9)



| Lug Size | Standard Wire Range (AWG) | Expanded Wire Range (AWG) | nVent ILSCO | | KST | | Burndy | | | | T&B | | | | Panduit | | | |
|----------|---------------------------|---------------------------|---------------------------|--------|---------------|--------|----------|--------|-----------|--------|----------|--------|------------------|--------|-------------------------|--------|----------|--------|
| | | | ILST-22K with die "D1322" | | KST2000D-1322 | | Y8MRB-1 | | MRE1022B* | | MR 20 | | ERG2002, ERG4002 | | BAT22-6 with die "2002" | | CT-1570 | |
| | | | Die Nest | Crimps | Die Nest | Crimps | Die Nest | Crimps | Die Nest | Crimps | Die Nest | Crimps | Die Nest | Crimps | Die Nest | Crimps | Die Nest | Crimps |
| 10 | 10 Sol/Str | 10-14 Str 10-14 Sol | 12-10 | 1 | 12-10 | 1 | 10 | 1 | 12-10 | 1 | 12-10 | 1 | C | 1 | C | 1 | 12-10 | 1 |

* Expanded Wire Range using Burndy MRE1022B is 10-12 Sol/Str

Additional Information

1. UL Listed to Category ZMVV and complimentary listed to category KDER when installed with the above listed tools
2. Recommended Strip Length = Barrel Length + 1/16 inch

J

Specialty

| | | | |
|------------------------------------------------------------------------------------------------------------------------------------------------------------------|-----------------------------------------------------------------------------------------------------------------------------------------------------------------------------|------------------------------------------------------------------------------------------------------------------------------------------------------------------------------------------|-------------------------------------------------------------------------------------------------------------------|
| <p>C</p>  <p>409</p> | <p>M</p>  <p>410</p> | <p>M</p>  <p>410</p> | <p>D167</p>  <p>411</p> |
| <p>CAN</p>  <p>412</p> | <p>NB</p>  <p>413</p> | <p>De-Ox</p>  <p>414</p> | |
| <p>DUCT SEAL</p>  <p>415</p> | <p>NBW</p>  <p>416</p> | <p>SSWC</p>  <p>417</p> | |
| <p>NWC</p>  <p>418</p> | <p>WM-B</p>  <p>419</p> | <p>WM</p>  <p>420 - 422</p> | |
| <p>Surge Protective Device Series RE - Residential</p>  <p>423</p> | <p>Surge Protective Device Series SE - Service Entrance</p>  <p>424 - 425</p> | <p>Surge Protective Device Series XE - Commercial & Industrial</p>  <p>426 - 427</p> | |

TYPE C

Features

- Manufactured from special bronze alloy except 100 and 200 amp styles. Arched bottoms
- All formed corners are designed with a radius

Benefits

- Spring type material ensures positive contact. Provide firm and secure mounting, and prevents expansion after fuse is inserted.
- Prevents fracturing

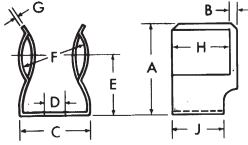

Fig. 1



Fig. 2



Fig. 3

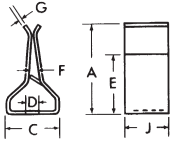

Fig. 4



Fig. 5



Fig. 6



Fig. 7

| Catalog Number | Figure Number | Amps - Volts | Dimensions (in.) | | | | | | | | | |
|----------------|---------------|--------------|------------------|------|-------|-----------|-------|---------|--------|------|-------|-------|
| | | | A | B | C | Bolt Size | D | E | F | G | H | J |
| C-10 | 1 | 30-250 | 7/8 | 3/64 | 19/32 | #10 | 13/64 | 17/32 | 9/16 | 1/32 | 19/32 | 1/2 |
| C-11 | 2 | 60-250 | 1-1/8 | 1/16 | 51/64 | #10 | 15/64 | 51/64 | 13/16 | 3/64 | 21/32 | 5/8 |
| C-13 | 3 | 60-600 | 1-9/32 | 1/16 | 1-1/8 | 1/4 | 17/64 | 13/16 | 1-1/16 | 3/64 | 21/32 | 5/8 |
| C-15 | 4 | 60-250 | 1-1/32 | - | 51/64 | #10 | 13/64 | 5/8 | 13/16 | 3/64 | - | 5/8 |
| C-16 | 5 | 100-250 | 1-43/64 | - | 29/32 | 1/4 | 17/64 | 1-11/64 | 1/8 | 5/64 | - | 7/8 |
| C-24 | 6 | 200-250/600 | 1-15/16 | - | 1-1/4 | 5/16 | 11/32 | 1-1/8 | 3/16 | 3/32 | - | 1-1/4 |
| C-28 | 7 | 50-250 | 61/64 | - | 1/2 | #8 | 3/16 | 23/32 | 7/64 | 3/64 | - | 1/2 |

** Stud hole center 9/32 from one side and 7/32 from other side.

* Slotted 13/64 x 13/32.

Wire Reinforced Fuse Clips

TYPE M

Features

- Manufactured from copper alloy
- Supplied with permanently installed steel spring
- Spring is heat treated and plated

Benefits

- Ensures high conductivity
- Ensures tighter grip and positive contact with either knife or ferrule type fuses.
- Prevents hydrogen embrittlement

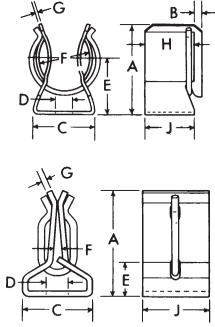

Fig. 1



Fig. 2

| Catalog Number | Figure Number | Amps - Volts | Dimensions (in.) | | | | | | | | | |
|----------------|---------------|--------------|------------------|------|-------|-----------|------------|-------|--------|------|-------|-------|
| | | | A | B | C | Bolt Size | D | E | F | G | H | J |
| M-161 | 1 | 30-250 | 27/32 | 1/16 | 19/32 | #10 | 13/64 | 17/32 | 9/16 | 1/32 | 17/32 | 1/2 |
| M-162 | 1 | 30-600 | 1-1/32 | 1/16 | 3/4 | 1/4 | 1/4 | 21/32 | 13/16 | 1/32 | 17/32 | 1/2 |
| M-163 | 1 | 60-250 | 1-13/64 | 1/16 | 51/64 | #10 | 7/32 | 51/64 | 13/16 | 3/64 | 21/32 | 21/32 |
| M-164 | 1 | 60-600 | 1-3/8 | 1/16 | 31/32 | #8 | 3/16 | 29/32 | 1-1/16 | 3/64 | 21/32 | 5/8 |
| M-165 | 2 | 100-250/600 | 1-23/64 | - | 29/32 | 1/4 | 17/64-Slot | - | 1/8 | 5/64 | - | 7/8 |

Copper Neutral Bars

RoHS
Compliant



TYPE D167

Features

- Manufactured from high strength copper tubing
- Range taking
- UL Recognized for 600 volts

Benefits

- Provides maximum conductivity
- A wide range of conductor sizes can be used in the same connector
- Ensures reliability for copper conductor

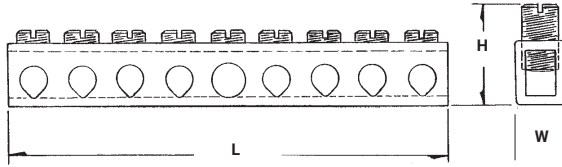

| Catalog Number | Number of Taps | Wire Range | | Dimensions (in.) | | | | | Mounting Hole Positions | |
|----------------|----------------|------------|------|------------------|--------------------------|-------|-----------|--------------------|----------------------------------------|------------------------|
| | | Main | Tap | L | Height With Maximum Wire | W | Bolt Size | Two Mounting Holes | From End of Bar to First Mounting Hole | Distance Between Holes |
| D167-4 | 4 | 4-14 | 6-14 | 2-3/4 | 3/4 | 11/32 | #10 | 13/64 | .581 (2nd hole) | 1.98 |
| D167-6 | 6 | 4-14 | 6-14 | 3-1/2 | 3/4 | 11/32 | #10 | 13/64 | .978 (3rd hole) | 1.98 |
| D167-8 | 8 | 4-14 | 6-14 | 4-7/16 | 3/4 | 11/32 | #10 | 13/64 | 1.375 (4th hole) | 1.98 |
| D167-10 | 10 | 4-14 | 6-14 | 5-1/8 | 3/4 | 11/32 | #10 | 13/64 | 1.772 (5th hole) | 1.98 |
| D167-12 | 12 | 4-14 | 6-14 | 5-15/16 | 3/4 | 11/32 | #10 | 13/64 | 2.169 (6th hole) | 1.98 |
| D167-14 | 14 | 4-14 | 6-14 | 6-23/32 | 3/4 | 11/32 | #10 | 13/64 | 2.566 (7th hole) | 1.98 |

All wire sizes, unless noted otherwise, are American Wire Gauge (AWG)
Tested to UL 486A/B and UL 467, UL File E6207

K

Copper Neutral Bars

TYPE CAN

Features

- Manufactured from high strength copper tubing
- Compact design
- Range taking
- Circuit bars inserted at a 20 angle
- Copper conductor only

Benefits

- Provides maximum conductivity
- Up to 42 circuit taps can be made in just 5 1/2 in of space
- A wide range of conductor sizes can be used in the same connector
- Provides easy wire insertion

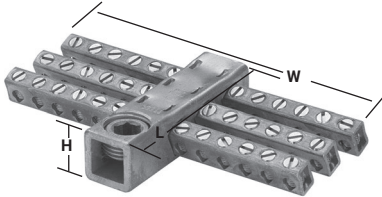

Fig. 1



Fig. 2



Fig. 3

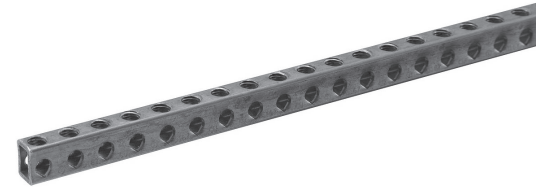

Fig. 4

| Catalog Number | Figure Number | Number of Taps | Wire Range | | Dimensions (in.) | | | |
|----------------|---------------|-------------------------------------------------------------------------------------------------------------------------------------------|------------|------|------------------|--------------------------|---------|---------------------------|
| | | | Main | Tap | L | Height With Maximum Wire | W | Two Tapped Mounting Holes |
| CAN-300 | 1 | 24 | 250kcmil-6 | 6-14 | 2-5/16 | 1-5/16 | 5-1/8 | 10-32 |
| CAN-301 | 1 | 30 | 250kcmil-6 | 6-14 | 3 | 1-5/16 | 4-13/32 | 10-32 |
| CAN-302 | 1 | 36 | 250kcmil-6 | 6-14 | 3 | 1-5/16 | 5-1/8 | 10-32 |
| CAN-303 | 1 | 42 | 250kcmil-6 | 6-14 | 3 | 1-7/16 | 5-1/2 | 10-32 |
| R-16 | 2 | Mounting block of general purpose (phenolic black) suitable for mounting any of CAN Neutrals. 2-1/2 in wide x 2-1/2 in long x 1 in thick. | | | | | | |
| E-223 | 3 | 10-32 x 1/2 in round head steel machine screws for fastening neutrals to mounting blocks. (Use lock washer to provide rigid assembly.) | | | | | | |
| E-153 | 3 | 1/4-28 wire pressure screw 7/16 in long. Screw is steel, zinc plated and chromate dipped. | | | | | | |
| N-174‡ | 4 | Supplied in 5' 9 in lengths. Approximately 174 outlets. Wire range 14-6. | | | | | | |

All wire sizes, unless noted otherwise, are American Wire Gauge (AWG)

Tested to UL 486A/B, UL File E6207

‡ Tested to UL 486A/B and UL 467, UL File E6207



Aluminum Neutral Bars

Dual Rated

RoHS
Compliant



TYPE NB

Features

- Preassembled, stacked neutral bars
- Available with phenolic base
- Electro-tin plated
- Fabricated from high strength 6061-T6 aluminum alloy

Benefits

- Compact, space saving design offers multiple range taking flexibility and is suitable for grounding applications
- Provides insulation from mounting surface
- Provides low contact resistance
- Suitable for use with either copper or aluminum conductors

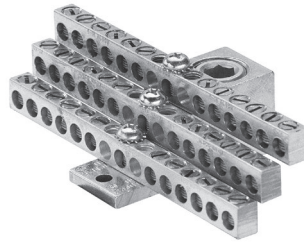
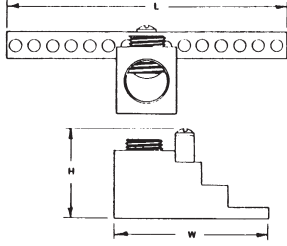

Fig. 1



Fig. 2

| Catalog Number | Firmware Number | Number of Circuit Taps | Wire Range | | Dimensions (in.) | | | Two Tapped Mounting Holes | Hex Size | |
|------------------|-----------------|------------------------|--------------|------------|-------------------------------|---------|---------|---------------------------|----------|------|
| | | | Circuit Taps | Line Loads | Approx. Height With Max. Wire | L | W | | Main | Tap |
| NB-350-12 | 1 | 12 | 14-4 | 350kcmil-6 | 1-17/32 | 4-23/32 | 2-17/32 | 10-32 | 3/8 | Slot |
| NB-350-12-W/R16* | 2 | 12 | 14-4 | 350kcmil-6 | 2-17/32 | 4-23/32 | 2-17/32 | 10-32 | 3/8 | Slot |
| NB-350-24 | 1 | 24 | 14-4 | 350kcmil-6 | 1-17/32 | 4-23/32 | 2-17/32 | 10-32 | 3/8 | Slot |
| NB-350-24-W/R16* | 2 | 24 | 14-4 | 350kcmil-6 | 2-17/32 | 4-23/32 | 2-17/32 | 10-32 | 3/8 | Slot |
| NB-350-30 | 1 | 30 | 14-4 | 350kcmil-6 | 1-17/32 | 4-3/32 | 2-17/32 | 10-32 | 3/8 | Slot |
| NB-350-30-W/R16* | 2 | 30 | 14-4 | 350kcmil-6 | 2-17/32 | 4-3/32 | 2-17/32 | 10-32 | 3/8 | Slot |
| NB-350-36 | 1 | 36 | 14-4 | 350kcmil-6 | 1-17/32 | 4-23/32 | 2-17/32 | 10-32 | 3/8 | Slot |
| NB-350-36-W/R16* | 2 | 36 | 14-4 | 350kcmil-6 | 2-17/32 | 4-23/32 | 2-17/32 | 10-32 | 3/8 | Slot |
| NB-350-42 | 1 | 42 | 14-4 | 350kcmil-6 | 1-17/32 | 5-11/32 | 2-17/32 | 10-32 | 3/8 | Slot |
| NB-350-42-W/R16* | 2 | 42 | 14-4 | 350kcmil-6 | 2-17/32 | 5-11/32 | 2-17/32 | 10-32 | 3/8 | Slot |

All wire sizes, unless noted otherwise, are American Wire Gauge (AWG)

* Part includes phenolic mounting block R-16

Tested to UL 486A/B, UL File E6207

K

TYPE De-Ox

nVent ILSCO Oxide inhibitor is available in three different formulas: NON-GRIT, ZINC, COPPER. Oxide Inhibitor is applied to the connector prior to inserting the wire conductor, providing an air-tight seal around the conductor, preventing oxides from forming. All three formulas are available in a variety of package sizes.

- NON-GRIT - nVent ILSCO De-Ox series is suitable for aluminum or copper terminations.
- ZINC - nVent ILSCO De-Ox-Z series contains flecks of zinc providing improved pull-out strength and reduced operating temperatures for aluminum or copper terminations.
- COPPER - nVent ILSCO De-Ox-C series contains flecks of copper providing improved pull-out strength and reduced operating temperatures for copper terminations.



| NON-GRIT | | |
|-----------------|-----------------------|-------------------------------|
| Catalog Number | Container Size & Type | Packaging |
| De-Ox -5CC | 5cc Packet | Display Carton of 150 |
| De-Ox-5CC-B4 | 5cc Packet | 4 Per Bag, 25 Bags Per Carton |
| De-Ox-10Z | 1 oz. Tube | Display Carton of 50 |
| De-Ox-40Z | 4 oz. Bottle | Display Carton of 12 |
| De-Ox-80Z | 8 oz. Bottle | Display Carton of 12 |
| De-Ox-1GAL | 1 Gallon Can | 1 Can |
| De-Ox-5GAL | 5 Gallon Bucket | 1 Bucket |
| UDe-Ox-V-40Z*+ | 4 oz. Bottle | Display Carton of 12 |
| UDe-Ox-V-80Z*+ | 8 oz. Bottle | Display Carton of 12 |
| ZINC | | |
| Catalog Number | Container Size & Type | Packaging |
| De-Ox-Z-5CC | 5cc Packet | Display Carton of 150 |
| De-Ox-Z-10Z | 1 oz. Tube | Display Carton of 50 |
| De-Ox-Z-40Z | 4 oz. Bottle | Display Carton of 12 |
| De-Ox-Z-80Z | 8 oz. Bottle | Display Carton of 12 |
| De-Ox-Z-1GAL | 1 Gallon Can | 1 Can |
| De-Ox-Z-5GAL | 5 Gallon Bucket | 1 Bucket |
| COPPER | | |
| Catalog Number | Container Size & Type | Packaging |
| De-Ox-C-5CC | 5cc Packet | Display Carton of 150 |
| De-Ox-C-10Z | 1 oz. Tube | Display Carton of 50 |
| De-Ox-C-40Z | 4 oz. Bottle | Display Carton of 12 |
| De-Ox-C-80Z | 8 oz. Bottle | Display Carton of 12 |
| De-Ox-C-1GAL | 1 Gallon Can | 1 Can |
| De-Ox-C-5GAL | 5 Gallon Bucket | 1 Bucket |

* V denotes synthetic base, chalk color, doesn't stain blankets, etc.

+ Not UL Listed

UL File E312012

TYPE DS

Features

- Available in 1 LB and 5 LB packages
- Remains pliable
- Non-corrosive
- Can be painted immediately

Benefits

- Provides convenience of selecting the right size for the job
- Will not dry out, crack and fall out of installation
- Will not irritate skin, or corrode metals, or have harmful effects on plastics
- No need to wait for product to dry



| Catalog Number | Package Quantity |
|----------------|------------------|
| DS-1 | 1 1 lb. bags |
| DS-5 | 1 5 lb. bags |

TYPE NBW

Features

- Individually packaged
- Aluminum nut and bolt
- Belleville washer

Benefits

- All components for mounting one connector are kept together to avoid mismatched hardware
- Provides consistent and even thermal expansion and contraction to prevent loosening of mounting hardware due to heat cycling
- Maintains tension on connection through thermal expansion and contraction

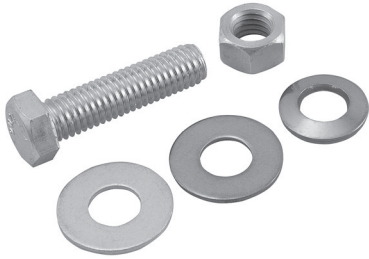

| Catalog Number | Bolt Size | Bolt Length | Included in Kit |
|----------------|-----------|-------------|-------------------------------------------------------------------------------------------------------------------|
| NBW-38-125 | 3/8-16 | 1-1/4 | Aluminum Nut, Stainless Steel Belleville Washer, Aluminum Flat Washer, Stainless Steel Flat Washer, Aluminum Bolt |
| NBW-50-150 | 1/2-13 | 1-1/2 | Aluminum Nut, Stainless Steel Belleville Washer, Aluminum Flat Washer, Stainless Steel Flat Washer, Aluminum Bolt |
| NBW-50-200 | 1/2-13 | 2 | Aluminum Nut, Stainless Steel Belleville Washer, Aluminum Flat Washer, Stainless Steel Flat Washer, Aluminum Bolt |
| NBW-50-250 | 1/2-13 | 2-1/2 | Aluminum Nut, Stainless Steel Belleville Washer, Aluminum Flat Washer, Stainless Steel Flat Washer, Aluminum Bolt |
| NBW-58-250 | 5/8-11 | 2-1/2 | Aluminum Nut, Stainless Steel Belleville Washer, Aluminum Flat Washer, Stainless Steel Flat Washer, Aluminum Bolt |
| NBW-58-300 | 5/8-11 | 3 | Aluminum Nut, Stainless Steel Belleville Washer, Aluminum Flat Washer, Stainless Steel Flat Washer, Aluminum Bolt |

Wire Management Clips

Stainless Steel

TYPE SSWC

Features

- Stainless steel
- Rounded edges
- Angled grip tabs

Benefits

- Corrosion resistant
- Prevents damage to cable
- Easy to slide on, teeth hold securely

Application:

Wire management clips are designed to clip onto a thin metal edge to provide a means to hold cables or wires in place. The clips have directional angled teeth built-in that spread apart as the clip is pushed onto the metal edge, and bites into the metal surface, creating a tight, secure grip on to the metal edge. The clip has a built in hook where the cable or wire is placed and held securely. These clips have become a common accessory for solar panel projects where they are used to hold up the ground and power wires that are daisy chained from panel to panel.

Material: 410 stainless steel

Dimensions:

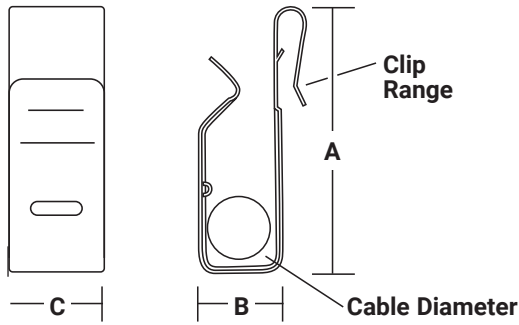

| Catalog Number | Range of Metal Thickness for the Clip Teeth | Maximum Cable Diameter | Dimensions (in.) | | |
|----------------|---------------------------------------------|------------------------|------------------|------|------|
| | | | A | B | C |
| I-1306 | .03 - .125 | .200 | .730 | .200 | .380 |
| I-1307 | .03 - .125 | .280 | .730 | .280 | .380 |
| I-1414 | .093 - .156 | .400 | 1.490 | .400 | .380 |
| I-2452A | .187 - .250 | .400 | 1.550 | .400 | .380 |

Wire Management Clips

Nylon

TYPE NWC

- Features**
- Nylon
 - Molded in grip tabs
 - Molded in eye slots

- Benefits**
- Corrosion and UV resistant
 - Securely attaches to metal edge
 - For attaching cable ties

Application:

Wire management clips are designed to clip onto a thin metal edge to provide a means to hold cables or wires in place. The clips have directional angled teeth built-in that spread apart as the clip is pushed onto the metal edge, and bites into the metal surface, creating a tight, secure grip on to the metal edge. The metal teeth are molded into a nylon housing that has a molded eye to accept a cable tie. The cable tie is then used to wrap around and secure the cables or wires. These clips have become a common accessory for solar panel projects where they are used to hold up the ground and power wires that are daisy chained from panel to panel.

Material: Nylon 6/6

Temperature range: -40 to 250 F

Holding strength: 45 lbs.

Cable tie length: 8 in

Dimensions:

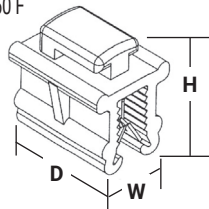

**Top Eye Type
(90° shown)**

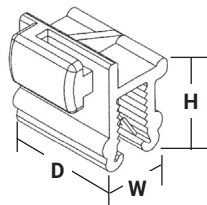

**Side Eye Type
(90° shown)**

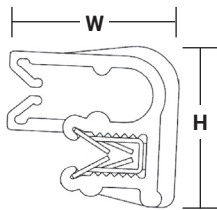

SEC-2W

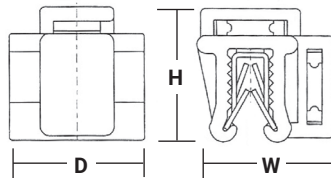

SC15

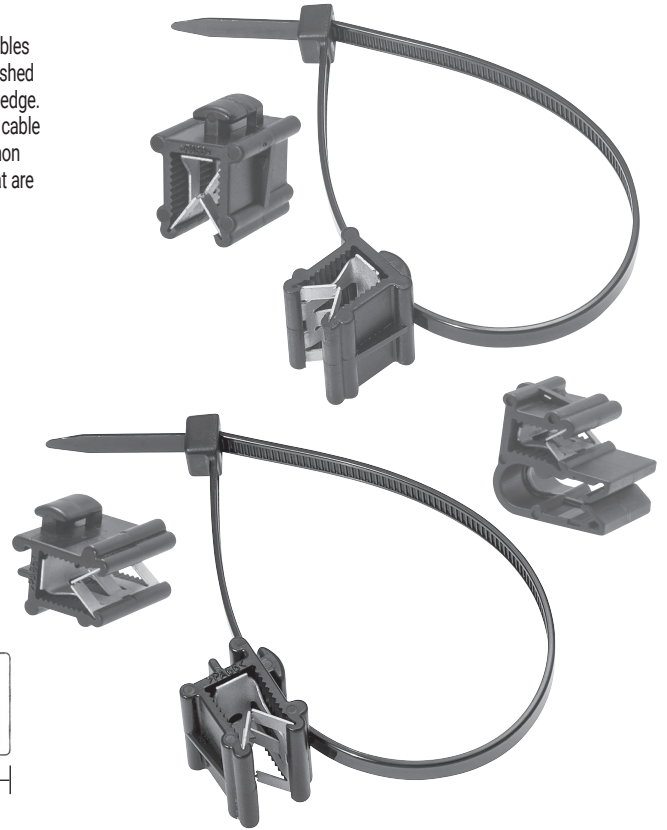

| Catalog Number | Range of Metal Thickness for the Clip Teeth | Cable Tie Included | Cable Tie Slot Orientation | Dimensions (in.) | | |
|----------------|---------------------------------------------|--------------------|----------------------------|------------------|------|------|
| | | | | H | W | D |
| SEC-2W | .03 - .125 | - | - | .760 | .820 | .610 |
| SC1-CTUV50 | .03 - .125 | Yes | Top 90° | .615 | .468 | .587 |
| SC1 | .03 - .125 | No | Top 90° | .615 | .468 | .587 |
| SC2-CTUV50 | .03 - .125 | Yes | Side 90° | .610 | .542 | .587 |
| SC2 | .03 - .125 | No | Side 90° | .610 | .542 | .587 |
| SC3-CTUV50 | .03 - .125 | Yes | Top in-line | .615 | .468 | .587 |
| SC3 | .03 - .125 | No | Top in-line | .615 | .468 | .587 |
| SC4-CTUV50 | .125 - .250 | Yes | Top in-line | .740 | .590 | .781 |
| SC4 | .125 - .250 | No | Top in-line | .740 | .590 | .781 |
| SC5-CTUV50 | .03 - .125 | Yes | Side in-line | .610 | .542 | .587 |
| SC5 | .03 - .125 | No | Side in-line | .610 | .542 | .587 |
| SC6-CTUV50 | .03 - .125 | Yes | Top 90° | .740 | .590 | .781 |
| SC6 | .03 - .125 | No | Top 90° | .740 | .590 | .781 |
| SC7-CTUV50 | .125 - .250 | Yes | Side 90° | .748 | .670 | .781 |
| SC7 | .125 - .250 | No | Side 90° | .748 | .670 | .781 |
| SC8-CTUV50 | .125 - .250 | Yes | Side in-line | .748 | .670 | .781 |
| SC8 | .125 - .250 | No | Side in-line | .748 | .670 | .781 |
| SC15 | .03 - .125 | No | Top & Side in-line | .585 | .605 | .595 |



Wire Markers Books

TYPE WM-B

Features

- White vinyl cloth material, permanent black marker text
- Rubber based adhesive backing
- Stitched cover
- Self-laminating unmarked vinyl material - WM-B-30-B and WM-B-60-B
- Clear over laminate vinyl material - WM-B-30-B and WM-B-60-B
- Rated to -50° to +250° F (-45° to +121° C) operating temperature

Benefits

- Industry proven, easily readable
- Long lasting grip on wire
- Durable binding of book
- Write on marker tab accepts pen, pencil, ink marker or stamp
- Permanent protection of user applied markings
- Usable at temperature extremes

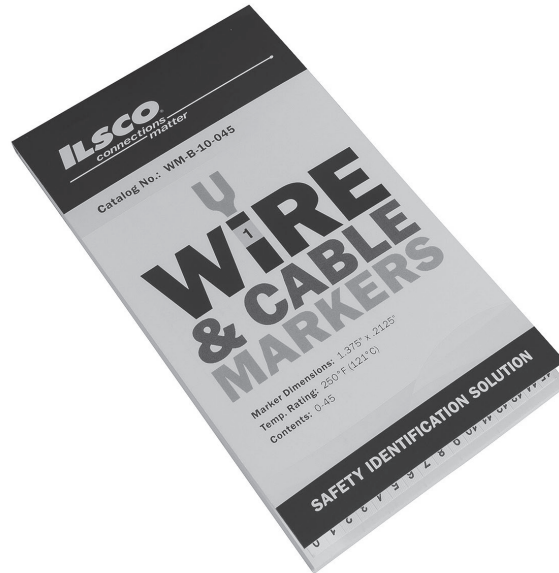

| Catalog Number | Material | Marker Text | Dimensions - in. (mm) | | Markers per Book |
|----------------|-----------------------|--------------------|-----------------------|------------------|------------------|
| | | | Length - in. (mm) | Width - in. (mm) | |
| WM-B-10-045 | Vinyl Cloth | 0-45 | 1.375 (34.9) | 0.213 (5.4) | 480 |
| WM-B-10-4690 | Vinyl Cloth | 46-90 | 1.375 (34.9) | 0.213 (5.4) | 480 |
| WM-B-10-AZ | Vinyl Cloth | A-Z, 0-15, +, -, / | 1.375 (34.9) | 0.213 (5.4) | 480 |
| WM-B-15-130 | Vinyl Cloth | 1-30 | 1.375 (34.9) | 0.213 (5.4) | 480 |
| WM-B-15-AZ | Vinyl Cloth | A-Z | 1.375 (34.9) | 0.213 (5.4) | 480 |
| WM-B-40-09 | Vinyl Cloth | 0-9, L1-L3, T1-T3 | 1.375 (34.9) | 0.213 (5.4) | 480 |
| WM-B-45-09 | Vinyl Cloth | 0-9 | 1.375 (34.9) | 0.213 (5.4) | 480 |
| WM-B-150-ABC | Vinyl Cloth | A, B, C | 1.375 (34.9) | 0.213 (5.4) | 480 |
| WM-B-30-B | Self Laminating Vinyl | Write On | 6.000 (152.4) | 1.000 (25.4) | 30 |
| WM-B-60-B | Self Laminating Vinyl | Write On | 3.000 (76.2) | 1.000 (25.4) | 60 |

K

Wire Markers

Slide/Snap-On

TYPE WM

Features

- Slide-on option
- Snap-on option
- Supplied in (10) strands per re-sealable bag, each strand contains (25) of the same character
- Angular cut ends
- Temperature range -22° to +140° F (-30° to +60° C)

Benefits

- Permanently secured marking, applied before end termination
- Convenient placement of marking before or after termination
- Offers millions of character combinations per bag
- Nesting multiple characters on same conductor
- Installable at extreme temperature conditions

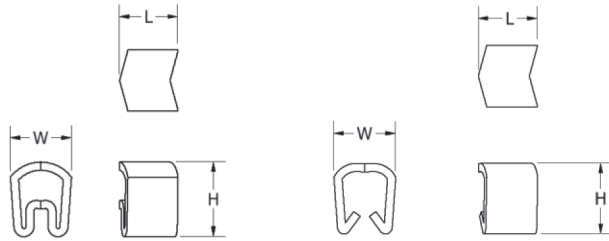

Fig. 1

Fig. 2



| Catalog Number | Figure Number | Color | Attachment Style | Marker Text | Wire Range | Wire Dia. - in. (mm) | Material | Dimensions - in. (mm) | | |
|----------------|---------------|-------|------------------|-----------------|------------|----------------------|-----------|-----------------------|-------------|-------------|
| | | | | | | | | H | W | D |
| WM-023-N-09 | 1 | NEMA* | Slide-On | 0-9 | 16-22 AWG | .051-.118 (1.3-3.0) | Soft PVC | 0.118 (3.0) | 0.142 (3.6) | 0.138 (3.5) |
| WM-023-W-09 | 1 | White | Slide-On | 0-9 | 16-22 AWG | .051-.118 (1.3-3.0) | Soft PVC | 0.118 (3.0) | 0.142 (3.6) | 0.138 (3.5) |
| WM-023-W-AJ | 1 | White | Slide-On | A-J | 16-22 AWG | .051-.118 (1.3-3.0) | Soft PVC | 0.118 (3.0) | 0.142 (3.6) | 0.138 (3.5) |
| WM-023-W-KT | 1 | White | Slide-On | K-T | 16-22 AWG | .051-.118 (1.3-3.0) | Soft PVC | 0.118 (3.0) | 0.142 (3.6) | 0.138 (3.5) |
| WM-023-W-UZ | 1 | White | Slide-On | U-Z, +, -, /, ⊥ | 16-22 AWG | .051-.118 (1.3-3.0) | Soft PVC | 0.118 (3.0) | 0.142 (3.6) | 0.138 (3.5) |
| WM-13-N-09 | 1 | NEMA* | Slide-On | 0-9 | 10-16 AWG | .099-.197 (2.5-5.0) | Soft PVC | 0.118 (3.0) | 0.217 (5.5) | 0.165 (4.2) |
| WM-13-W-09 | 1 | White | Slide-On | 0-9 | 10-16 AWG | .099-.197 (2.5-5.0) | Soft PVC | 0.118 (3.0) | 0.217 (5.5) | 0.165 (4.2) |
| WM-13-W-AJ | 1 | White | Slide-On | A-J | 10-16 AWG | .099-.197 (2.5-5.0) | Soft PVC | 0.118 (3.0) | 0.217 (5.5) | 0.165 (4.2) |
| WM-13-W-KT | 1 | White | Slide-On | K-T | 10-16 AWG | .099-.197 (2.5-5.0) | Soft PVC | 0.118 (3.0) | 0.217 (5.5) | 0.165 (4.2) |
| WM-13-W-UZ | 1 | White | Slide-On | U-Z, +, -, /, ⊥ | 10-16 AWG | .099-.197 (2.5-5.0) | Soft PVC | 0.118 (3.0) | 0.217 (5.5) | 0.165 (4.2) |
| WM-103-N-09 | 2 | NEMA* | Snap-On | 0-9 | 16-22 AWG | .094-.118 (2.4-3.0) | Rigid PVC | 0.118 (3.0) | 0.142 (3.6) | 0.146 (3.7) |
| WM-103-W-09 | 2 | White | Snap-On | 0-9 | 16-22 AWG | .094-.118 (2.4-3.0) | Rigid PVC | 0.118 (3.0) | 0.142 (3.6) | 0.146 (3.7) |
| WM-103-W-AJ | 2 | White | Snap-On | A-J | 16-22 AWG | .094-.118 (2.4-3.0) | Rigid PVC | 0.118 (3.0) | 0.142 (3.6) | 0.146 (3.7) |
| WM-103-W-KT | 2 | White | Snap-On | K-T | 16-22 AWG | .094-.118 (2.4-3.0) | Rigid PVC | 0.118 (3.0) | 0.142 (3.6) | 0.146 (3.7) |
| WM-103-W-UZ | 2 | White | Snap-On | U-Z, +, -, /, ⊥ | 16-22 AWG | .094-.118 (2.4-3.0) | Rigid PVC | 0.118 (3.0) | 0.142 (3.6) | 0.146 (3.7) |
| M-203-N-09 | 2 | NEMA* | Snap-On | 0-9 | 12-14 AWG | .118-.157 (3.0-4.0) | Rigid PVC | 0.118 (3.0) | 0.165 (4.2) | 0.177 (4.5) |
| WM-203-W-09 | 2 | White | Snap-On | 0-9 | 12-14 AWG | .118-.157 (3.0-4.0) | Rigid PVC | 0.118 (3.0) | 0.165 (4.2) | 0.177 (4.5) |
| WM-203-W-AJ | 2 | White | Snap-On | A-J | 12-14 AWG | .118-.157 (3.0-4.0) | Rigid PVC | 0.118 (3.0) | 0.165 (4.2) | 0.177 (4.5) |
| WM-203-W-KT | 2 | White | Snap-On | K-T | 12-14 AWG | .118-.157 (3.0-4.0) | Rigid PVC | 0.118 (3.0) | 0.165 (4.2) | 0.177 (4.5) |
| WM-203-W-UZ | 2 | White | Snap-On | U-Z, +, -, /, ⊥ | 12-14 AWG | .118-.157 (3.0-4.0) | Rigid PVC | 0.118 (3.0) | 0.165 (4.2) | 0.177 (4.5) |

UL94-V0 Flammability rating

INSTALLATION TOOL FOR SLIDE ON WIRE MARKERS SOLD SEPARATELY

* NEMA Colors:

0 - Black with white character
 4 - Yellow with black character
 8 - Grey with black character

1 - Brown with white character
 5 - Green with white character
 9 - White with black character

2 - Red with white character
 6 - Blue with white character

3 - Orange with black character
 7 - Purple with white character

K

Wire Markers Cassette

TYPE
WM

Features

- Compact size; 3.500 in W x 2.700 in D x .850 in H
- Contains 500 slide-on style markers, refillable
- Double-sided entry
- Supplied with stainless steel installation tool inside the cassette
- Stainless steel installation tool features wire receiver hole
- Marker and cassette temperature rating -22° to 140° F
- Each slot holds one strand of (25) slide on wire markers

Benefits

- Easy to carry, readily available
- Reusable and customizable to user needs
- Conveniently dispense parts on either side of cassette
- Guides markers onto un-terminated end of wire
- Aligns wire for easy marker installation
- Holds up in extreme temperature conditions
- Provides quick visual identification and marker organization



| Catalog Number | Cassette Color | Groove per Side | Includes Tool | Wire Range | Wire Diameter – in (mm) | Marker color | Markers per Book |
|--------------------------------|----------------|-----------------|---------------|------------|-------------------------|--------------|------------------|
| Wire Marker Accessories | | | | | | | |
| WM-CA02-N-09 | Red | 12 | WM-T02-M | 16-22 AWG | .051-.118 (1.3-3.0) | NEMA* | 0-9 |
| WM-CA02-W-09 | Red | 12 | WM-T02-M | 16-22 AWG | .051-.118 (1.3-3.0) | White | 0-9 |
| WM-CA02-W-AJ | Red | 12 | WM-T02-M | 16-22 AWG | .051-.118 (1.3-3.0) | White | A-J |
| WM-CA02-W-KT | Red | 12 | WM-T02-M | 16-22 AWG | .051-.118 (1.3-3.0) | White | K-T |
| WM-CA02-W-UZ | Red | 12 | WM-T02-M | 16-22 AWG | .051-.118 (1.3-3.0) | White | U-Z |
| WM-CA10-N-09 | Blue | 10 | WM-T10-M | 10-16 AWG | .099-.197 (2.5-5.0) | NEMA* | 0-9 |
| WM-CA10-W-09 | Blue | 10 | WM-T10-M | 10-16 AWG | .099-.197 (2.5-5.0) | White | 0-9 |
| WM-CA10-W-AJ | Blue | 10 | WM-T10-M | 10-16 AWG | .099-.197 (2.5-5.0) | White | A-J |
| WM-CA10-W-KT | Blue | 10 | WM-T10-M | 10-16 AWG | .099-.197 (2.5-5.0) | White | K-T |
| WM-CA10-W-UZ | Blue | 10 | WM-T10-M | 10-16 AWG | .099-.197 (2.5-5.0) | White | U-Z |

WM - Wire Marker Installation Tool



| Catalog Number | Fits | Tool Dimensions – in. (mm) | |
|----------------|----------------|----------------------------|-------------|
| | | L | W |
| WM-T02-M | WM-023 Markers | 3.937 (100.0) | 0.122 (3.1) |
| WM-T10-M | WM-13 Markers | 3.937 (100.0) | 0.197 (5.0) |

* NEMA Colors:

0 - Black with white character
4 - Yellow with black character
8 - Grey with black character

1 - Brown with white character
5 - Green with white character
9 - White with black character

2 - Red with white character
6 - Blue with white character

3 - Orange with black character
7 - Purple with white character

Wire Markers Kit

TYPE WM

Features

- 50 compartments
- Double latch and carry handle
- 10,000 total markers per case
- Contains 2 stainless steel installation tools
- Carrying case temperature rating -22° to +140° F (-30° to +60° C)

Benefits

- Marker organization for quick identification and use
- Secured cover, easy to carry
- Offers millions of character combinations, supports large scale marking activity
- Spare tool
- Holds up in extreme temperature conditions



| Catalog Number | Color | Wire Range | Wire Dia. - in. (mm) | Marker Color | Application Tool | Dimensions - in. (mm) | | |
|----------------|-------|------------|----------------------|--------------|------------------|-----------------------|----------------|--------------|
| | | | | | | H | W | D |
| WM-B02-W | White | 16-22 AWG | .051-.118 (1.3-3.0) | White | WM-T02-M | 16.150 (410.2) | 12.600 (320.0) | 2.000 (50.8) |
| WM-B02-NW | NEMA | 16-22 AWG | .051-.118 (1.3-3.0) | NEMA* | WM-T02-M | 16.150 (410.2) | 12.600 (320.0) | 2.000 (50.8) |
| WM-B10-W | White | 10-16 AWG | .099-.197 (2.5-5.0) | White | WM-T10-M | 16.150 (410.2) | 12.600 (320.0) | 2.000 (50.8) |
| WM-B10-NW | NEMA | 10-16 AWG | .099-.197 (2.5-5.0) | NEMA* | WM-T10-M | 16.150 (410.2) | 12.600 (320.0) | 2.000 (50.8) |

Kit contents include:

400 pieces of each number, 0-9

200 pieces of each letter, A-Z

200 pieces of each symbol, =, -, /, \perp

2 Application Tools

K

* NEMA Colors:

0 - Black with white character
4 - Yellow with black character
8 - Grey with black character

1 - Brown with white character
5 - Green with white character
9 - White with black character

2 - Red with white character
6 - Blue with white character

3 - Orange with black character
7 - Purple with white character

nVent ILSCO Surgency

Surge Protective Device

Series RE - Residential



TYPE SPD

Features

- Whole house surge protection
- Compact NEMA polycarbonate enclosure
- Blue indicator LED
- 50 kA surge current strength
- Optional electrical noise filter
- UL 1449 Listed with advanced safety Integrated threaded female hub
- Five year warranty
- Optional flush mount plate available for mounting versatility

Benefits

- Protect residence from electrical surges
- Easily installed outdoors or indoors, non-submersible
- Easy monitoring of surge protection status
- Withstands severe lightning strikes
- Protects valuable electronics & appliances
- Product longevity in the most demanding environments
- Quick installation

1/2 IN. CONDUIT FITTING

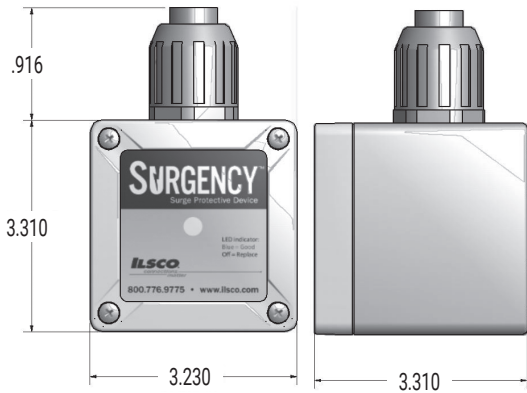

Fig. 1

3/4 IN. CONDUIT FITTING

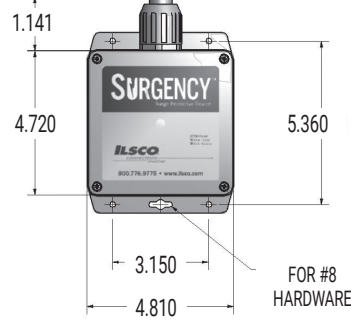

Fig. 2



| Catalog Number | Figure Number | Lead Wire Size | Electrical Characteristics | | | | | Nominal Discharge Current | Short Circuit Current Rating (SCCR) | UL/CSA Type* | UL Voltage Protection Rating | | | | Conduit Size (in.) |
|----------------|---------------|----------------|----------------------------|--------|--------------|-----------------|---------------|---------------------------|-------------------------------------|--------------|------------------------------|-----|------|------|--------------------|
| | | | Phase | System | AC Frequency | Nominal Voltage | Noise Filter‡ | | | | L-L | L-N | L-G | N-G | |
| RE-050-1R1X-AA | 1 | 12 AWG | 1 | SPLIT | 50/60 Hz | 120/240 V | - | 20 kA | 200 kA | 1 | 1000 | - | 700 | - | 1/2 |
| RE-050-1R1X-CA | 1 | 12 AWG | 1 | SPLIT | 50/60 Hz | 120/240 V | Yes | 20 kA | 200 kA | 2 | 1200 | - | 600 | - | 1/2 |
| RE-050-1P1X-AA | 1 | 12 AWG | 1 | SINGLE | 50/60 Hz | 120 V | - | 20 kA | 200 kA | 1 | - | 700 | 700 | 1200 | 1/2 |
| RE-050-1P1X-CA | 1 | 12 AWG | 1 | SINGLE | 50/60 Hz | 120 V | Yes | 20 kA | 200 kA | 2 | - | 600 | 1200 | 600 | 1/2 |
| RE-050-Y3WX-A | 2 | 10 AWG | 3 | WYE | 50/60 Hz | 208Y/120 V | - | 20 kA | 200 kA | 1 | 1000 | - | 600 | - | 3/4 |
| RE-050-Y3WX-C | 2 | 10 AWG | 3 | WYE | 50/60 Hz | 208Y/120 V | Yes | 20 kA | 200 kA | 2 | 1200 | - | 700 | - | 3/4 |

Tested and Certified:

Type 1 SPDs (no filter) = UL 1449 (4th Edition), CSA C22.2 No. 269.1-14

Type 2 SPDs (filter) = UL 1449, UL 1283, CSA C22.2 No. 269.2-13, CSA C22.2 No. 8-13

K

Operating temperature range -40° - +150° F (-4° - +65° C)

Enclosure is rated to NEMA/UL Type 1, 2, 3, 3R, 3X, 4 and 4X

‡ Advanced UL 1283 rated electrical noise filter

Δ Mounting flange kit included

* Type 1 = Permanently connected SPDs permitted to be installed between the secondary of the service transformer and the line side of the service equipment overcurrent device, as well as the load side, permitted to be installed without an external overcurrent protective device on the line side of the service entrance

Type 2 = Permanently connected SPDs intended for installation on the load side of the service equipment overcurrent device; including SPDs located at the branch panel

| Option Code | UL/CSA Type | Indicator LED | Advanced Filtering |
|-------------|-------------|---------------|--------------------|
| A | 1 | • | |
| C | 2 | • | • |

Surgency

Surge Protective Device - Type 1

Series SE - Service Entrance



TYPE SPD

Features

- Commercial & industrial up to 4-mode surge protection
- Compact NEMA polycarbonate enclosure
- Indicator LED, blue for proper operational status, red to replace, optional audible alarm and relay contacts
- Surge current strength up to 100 kA
- UL 1449 Listed with advanced safety Integrated threaded female hub
- Five year warranty
- Optional flush mount plate available for mounting versatility

Benefits

- First line of defense against externally generated surges
- Mounted outdoors or indoors external or internal to any electrical panel, non-submersible
- Easy monitoring of surge protection status
- Withstands severe lightning strikes, up to 100 kA surge current per mode provides extended service life
- Product longevity in the most demanding environments
- Quick installation

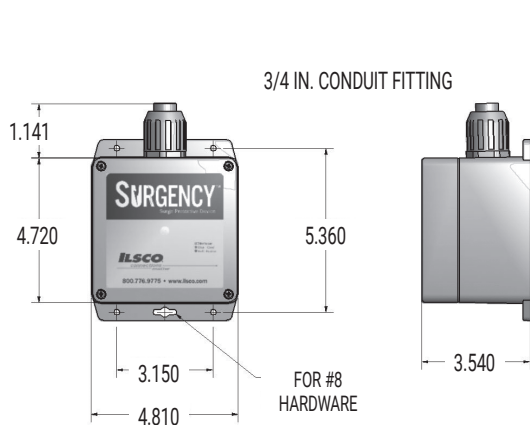

Fig. 1

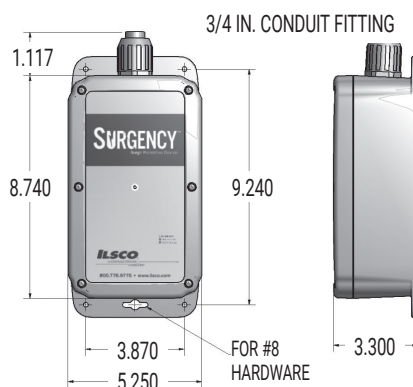

Fig. 2



| Catalog Number | Figure Number | Electrical Characteristics | | | | Nominal Voltage | Nominal Discharge Current | Short Circuit Current Rating (SCCR) | UL Voltage Protection Rating | | | | Conduit Size (in.) |
|----------------|---------------|----------------------------|--------|------------------------|--------------|-----------------|---------------------------|-------------------------------------|------------------------------|------|------|------|--------------------|
| | | Phase | System | Per Mode Surge Current | AC Frequency | | | | L-L | L-N | L-G | N-G | |
| SE-050-1S1X-* | 1 | 1 | SPLIT | 50 kA | 50/60 Hz | 120/240 V | 20 kA | 200 kA | 1200 | 600 | 1200 | 600 | 3/4 |
| SE-100-1S1X-* | 2 | 1 | SPLIT | 100 kA | 50/60 Hz | 120/240 V | 20 kA | 200 kA | 1000 | 700 | 1000 | 700 | 3/4 |
| SE-050-3Y1X-* | 1 | 3 | WYE | 50 kA | 50/60 Hz | 208Y/120 V | 20 kA | 200 kA | 1200 | 600 | 1200 | 600 | 3/4 |
| SE-100-3Y1X-* | 2 | 3 | WYE | 100 kA | 50/60 Hz | 208Y/120 V | 20 kA | 200 kA | 1000 | 700 | 1000 | 700 | 3/4 |
| SE-050-3Y2X-* | 1 | 3 | WYE | 50 kA | 50/60 Hz | 480Y/277 V | 20 kA | 200 kA | 2500 | 1200 | 2500 | 1200 | 3/4 |
| SE-100-3Y2X-* | 2 | 3 | WYE | 100 kA | 50/60 Hz | 480Y/277 V | 20 kA | 200 kA | 2000 | 1200 | 2000 | 1200 | 3/4 |
| SE-050-3N4X-* | 1 | 3 | DELTA | 50 kA | 50/60 Hz | 480 V | 20 kA | 200 kA | 4000 | - | 1800 | - | 3/4 |
| SE-100-3N4X-* | 2 | 3 | DELTA | 100 kA | 50/60 Hz | 480 V | 20 kA | 200 kA | 4000 | - | 1800 | - | 3/4 |

Tested and Certified:

Type 1 SPDs (no filter) = UL 1449 (4th Edition), CSA C22.2 No. 269.1-14

Operating temperature range -40 to +150° F

Enclosure is rated to NEMA/UL Type 1, 2, 3, 3R, 3X, 4 and 4X

Type 1 = Permanently connected SPDs permitted to be installed between the secondary of the service transformer and the line side of the service equipment overcurrent device, as well as the load side, permitted to be installed without an external overcurrent protective device on the line side of the service entrance

Add on option code to catalog number

| Option Code | UL/CSA Type | Indicator LED | Audible Alarm | Dry Relay Contact |
|-------------|-------------|---------------|---------------|-------------------|
| A | 1 | • | | |
| B | 1 | • | • | • |

* Indicates package and option code - A, B



Surgency

Surge Protective Device - Type 2

Series SE - Service Entrance



TYPE SPD

Features

- Commercial & industrial up to 4-mode surge protection
- Compact NEMA polycarbonate enclosure
- Indicator LED, blue for proper operational status, red to replace, optional audible alarm and relay contacts
- Surge current strength up to 100 kA
- UL 1283 electrical noise filter
- UL 1449 Listed with advanced safety Integrated threaded female hub
- Five year warranty
- Optional flush mount plate available for mounting versatility

Benefits

- First line of defense against externally generated surges
- Mounted outdoors or indoors external or internal to any electrical panel, non-submersible
- Easy monitoring of surge protection status
- Withstands severe lightning strikes, up to 100 kA surge current per mode provides extended service life
- Protects critical commercial and industrial equipment
- Product longevity in the most demanding environments
- Quick installation

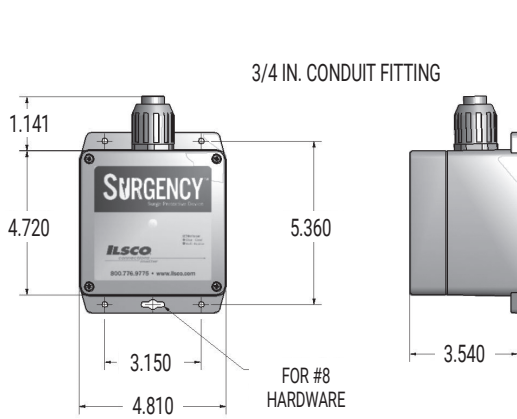

Fig. 1

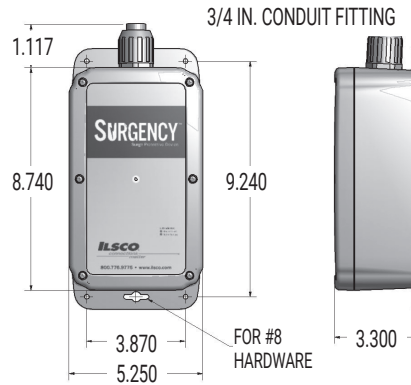

Fig. 2



| Catalog Number | Figure Number | Electrical Characteristics | | | | Nominal Voltage | Nominal Discharge Current | Short Circuit Current Rating (SCCR) | UL Voltage Protection Rating | | | | Conduit Size (in.) |
|----------------|---------------|----------------------------|--------|------------------------|--------------|-----------------|---------------------------|-------------------------------------|------------------------------|------|------|------|--------------------|
| | | Phase | System | Per Mode Surge Current | AC Frequency | | | | L-L | L-N | L-G | N-G | |
| SE-050-1S1X-* | 1 | 1 | SPLIT | 50 kA | 50/60 Hz | 120/240 V | 20 kA | 200 kA | 1200 | 700 | 1200 | 600 | 3/4 |
| SE-100-1S1X-* | 2 | 1 | SPLIT | 100 kA | 50/60 Hz | 120/240 V | 20 kA | 200 kA | 1200 | 700 | 1200 | 700 | 3/4 |
| SE-050-3Y1X-* | 1 | 3 | WYE | 50 kA | 50/60 Hz | 208Y/120 V | 20 kA | 200 kA | 1200 | 700 | 1200 | 600 | 3/4 |
| SE-100-3Y1X-* | 2 | 3 | WYE | 100 kA | 50/60 Hz | 208Y/120 V | 20 kA | 200 kA | 1200 | 700 | 1200 | 700 | 3/4 |
| SE-050-3Y2X-* | 1 | 3 | WYE | 50 kA | 50/60 Hz | 480Y/277 V | 20 kA | 200 kA | 2500 | 1200 | 2500 | 1200 | 3/4 |
| SE-100-3Y2X-* | 2 | 3 | WYE | 100 kA | 50/60 Hz | 480Y/277 V | 20 kA | 200 kA | 2500 | 1200 | 2500 | 1200 | 3/4 |
| SE-050-3N4X-* | 1 | 3 | DELTA | 50 kA | 50/60 Hz | 480 V | 20 kA | 200 kA | 4000 | - | 1800 | - | 3/4 |
| SE-100-3N4X-* | 2 | 3 | DELTA | 100 kA | 50/60 Hz | 480 V | 20 kA | 200 kA | 4000 | - | 1800 | - | 3/4 |



Tested and Certified:
Type 2 SPDs (filter) = UL 1449, UL 1283,
CSA C22.2 No. 269.2-13, CSA C22.2 No. 8-13

Operating temperature range -40 to +150° F
Enclosure is rated to NEMA/UL Type 1, 2, 3, 3R, 3X, 4 and 4X

Type 2 = Permanently connected SPDs intended for installation on the load side of the service equipment overcurrent device; including SPDs located at the branch panel

Add on option code to catalog number

| Option Code | UL/CSA Type | Indicator LED | Audible Alarm | Dry Relay Contact | Electrical Noise Filter‡ |
|-------------|-------------|---------------|---------------|-------------------|--------------------------|
| C | 2 | • | | | • |
| D | 2 | • | • | • | • |

* Indicates package and option code - C, or D
‡ Advanced UL 1283 rated electrical noise filter

Surgency

Surge Protective Device - Type 1

Series XE - Commercial & Industrial



TYPE SPD

Features

- Commercial & industrial surge protection, up to 7 protection modes
- Compact NEMA polycarbonate enclosure
- One blue LED per phase reporting power to the phases and one red LED indicating service required or phase loss, optional audible alarm and relay contacts
- Surge current strength up to 100 kA
- UL 1449 Listed with advanced safety Integrated threaded female hub
- Ten year warranty
- Optional flush mount plate available for mounting versatility

Benefits

- Protects equipment downstream of electrical service entrance
- Mounted outdoors or indoors external or internal to any electrical panel, non-submersible
- Easy monitoring of surge protection status
- Withstands severe lightning strikes, up to 100 kA surge current per mode provides extended service life
- Product longevity in the most demanding environments
- Quick installation

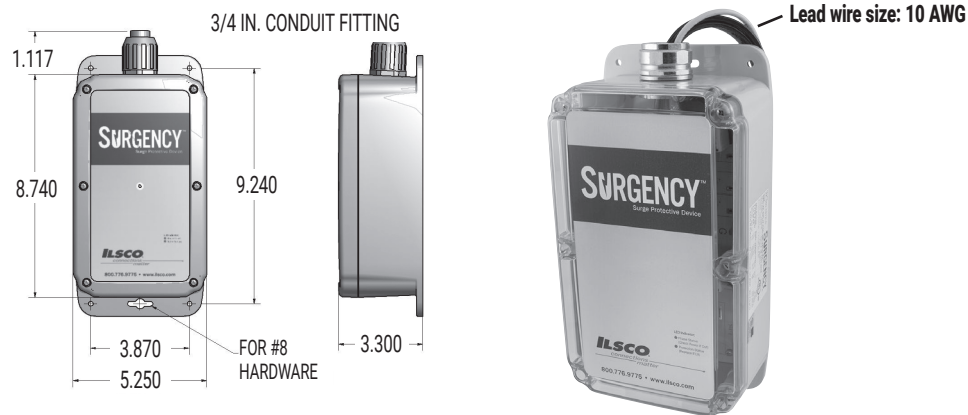

| Catalog Number | Electrical Characteristics | | | | | Nominal Discharge Current | Short Circuit Current Rating (SCCR) | UL Voltage Protection Rating (VPR) | | | | Conduit Size (in.) |
|----------------|----------------------------|--------------|------------------------|--------------|-----------------|---------------------------|-------------------------------------|------------------------------------|----------|----------|------|--------------------|
| | Phase | System | Per Mode Surge Current | AC Frequency | Nominal Voltage | | | L-L | L-N | L-G | N-G | |
| XE-050-1P1X-* | 1 | SINGLE | 50 kA | 50/60 Hz | 100~140 V | 20 kA | 200 kA | - | 700 | 700 | 700 | 3/4 |
| XE-100-1P1X-* | 1 | SINGLE | 100 kA | 50/60 Hz | 100~140 V | 20 kA | 200 kA | - | 700 | 700 | 700 | 3/4 |
| XE-050-1P2X-* | 1 | SINGLE | 50 kA | 50/60 Hz | 220~280 V | 20 kA | 200 kA | - | 1200 | 1200 | 1200 | 3/4 |
| XE-100-1P2X-* | 1 | SINGLE | 100 kA | 50/60 Hz | 220~280 V | 20 kA | 200 kA | - | 1200 | 1200 | 1200 | 3/4 |
| XE-050-1S1X-* | 1 | SPLIT | 50 kA | 50/60 Hz | 120/240 V | 20 kA | 200 kA | 1000 | 700 | 700 | 700 | 3/4 |
| XE-100-1S1X-* | 1 | SPLIT | 100 kA | 50/60 Hz | 120/240 V | 20 kA | 200 kA | 1000 | 700 | 700 | 700 | 3/4 |
| XE-050-3Y1X-* | 3 | WYE | 50 kA | 50/60 Hz | 208Y/120 V | 20 kA | 200 kA | 1000 | 600 | 600 | 700 | 3/4 |
| XE-100-3Y1X-* | 3 | WYE | 100 kA | 50/60 Hz | 208Y/120 V | 20 kA | 200 kA | 1000 | 700 | 700 | 700 | 3/4 |
| XE-050-3Y2X-* | 3 | WYE | 50 kA | 50/60 Hz | 480Y/277 V | 20 kA | 200 kA | 2000 | 1200 | 1200 | 1200 | 3/4 |
| XE-100-3Y2X-* | 3 | WYE | 100 kA | 50/60 Hz | 480Y/277 V | 20 kA | 200 kA | 2000 | 1200 | 1200 | 1200 | 3/4 |
| XE-050-3Y3X-* | 3 | WYE | 50 kA | 50/60 Hz | 600Y/347 V | 20 kA | 200 kA | 2500 | 1500 | 1500 | 1500 | 3/4 |
| XE-100-3Y3X-* | 3 | WYE | 100 kA | 50/60 Hz | 600Y/347 V | 20 kA | 200 kA | 3000 | 1500 | 1500 | 1500 | 3/4 |
| XE-050-3D1X-* | 3 | HI-LEG DELTA | 50 kA | 50/60 Hz | 240D/120 V | 20 kA | 200 kA | 1200/1800 | 700/1200 | 700/1200 | 700 | 3/4 |
| XE-100-3D1X-* | 3 | HI-LEG DELTA | 100 kA | 50/60 Hz | 240D/120 V | 20 kA | 200 kA | 1200/1800 | 700/1200 | 700/1200 | 700 | 3/4 |
| XE-050-3N4X-* | 3 | DELTA | 50 kA | 50/60 Hz | 480 V | 20 kA | 200 kA | 1800 | - | 1800 | - | 3/4 |
| XE-100-3N4X-* | 3 | DELTA | 100 kA | 50/60 Hz | 480 V | 20 kA | 200 kA | 1800 | - | 1800 | - | 3/4 |
| XE-050-3N6X-* | 3 | DELTA | 50 kA | 50/60 Hz | 600 V | 20 kA | 200 kA | 3000 | - | 3000 | - | 3/4 |
| XE-100-3N6X-* | 3 | DELTA | 100 kA | 50/60 Hz | 600 V | 20 kA | 200 kA | 3000 | - | 3000 | - | 3/4 |

Tested and Certified:
Type 1 SPDs (no filter) = UL 1449 (4th Edition), CSA C22.2 No. 269.1-14

Operating temperature range -40 to +150° F

Enclosure is rated to NEMA/UL Type 1, 2, 3, 3R, 3X, 4 and 4X

Type 1 = Permanently connected SPDs permitted to be installed between the secondary of the service transformer and the line side of the service equipment overcurrent device, as well as the load side, permitted to be installed without an external overcurrent protective device on the line side of the service entrance

Add on option code to catalog number

| Option Code | UL/CSA Type | Indicator LED | Audible Alarm | Dry Relay Contact |
|-------------|-------------|---------------|---------------|-------------------|
| A | 1 | • | | |
| B | 1 | • | • | • |

*Indicates Package and option code- A, B



Surgency

Surge Protective Device - Type 2

Series XE - Commercial & Industrial



TYPE
SPD

Features

- Commercial & industrial surge protection, up to 7 protection modes
- Compact NEMA polycarbonate enclosure
- One blue LED per phase reporting power to the phases and one red LED indicating service required or phase loss, optional audible alarm and relay contacts
- Surge current strength up to 100 kA
- UL 1283 electrical noise filter
- UL 1449 Listed with advanced safety Integrated threaded female hub
- Ten year warranty
- Optional flush mount plate available for mounting versatility

Benefits

- Protects equipment downstream of electrical service entrance
- Mounted outdoors or indoors external or internal to any electrical panel, non-submersible
- Easy monitoring of surge protection status
- Withstands severe lightning strikes, up to 100 kA surge current per mode provides extended service life
- Protects critical commercial and industrial equipment
- Product longevity in the most demanding environments
- Quick installation

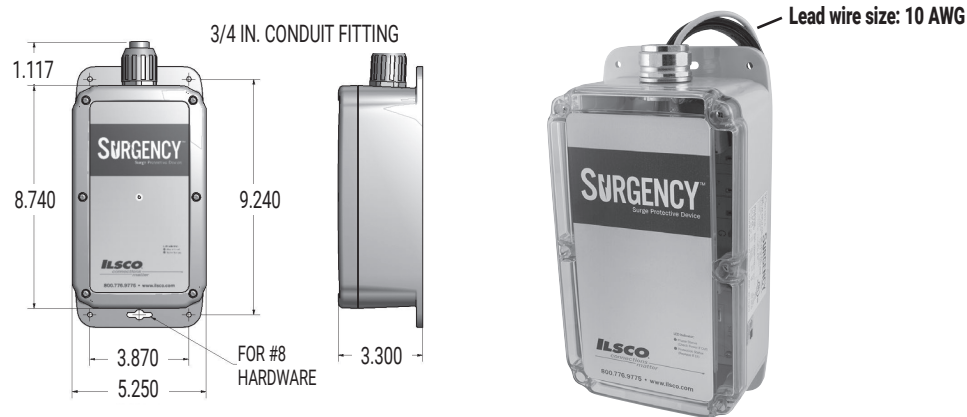

| Catalog Number | Electrical Characteristics | | | | | Nominal Discharge Current | Short Circuit Current Rating (SCCR) | UL Voltage Protection Rating | | | | Conduit Size (in.) |
|----------------|----------------------------|--------------|------------------------|--------------|----------------|---------------------------|-------------------------------------|------------------------------|----------|----------|------|--------------------|
| | Phase | System | Per Mode Surge Current | AC Frequency | Nminal Voltage | | | L-L | L-N | L-G | N-G | |
| XE-050-1P1X-* | 1 | SINGLE | 50 kA | 50/60 Hz | 100~140 V | 20 kA | 200 kA | - | 700 | 700 | 700 | 3/4 |
| XE-100-1P1X-* | 1 | SINGLE | 100 kA | 50/60 Hz | 100~140 V | 20 kA | 200 kA | - | 700 | 700 | 700 | 3/4 |
| XE-050-1P2X-* | 1 | SINGLE | 50 kA | 50/60 Hz | 220~280 V | 20 kA | 200 kA | - | 1200 | 1200 | 1200 | 3/4 |
| XE-100-1P2X-* | 1 | SINGLE | 100 kA | 50/60 Hz | 220~280 V | 20 kA | 200 kA | - | 1200 | 1200 | 1200 | 3/4 |
| XE-050-1S1X-* | 1 | SPLIT | 50 kA | 50/60 Hz | 120/240 V | 20 kA | 200 kA | 1200 | 700 | 700 | 700 | 3/4 |
| XE-100-1S1X-* | 1 | SPLIT | 100 kA | 50/60 Hz | 120/240 V | 20 kA | 200 kA | 1200 | 700 | 700 | 700 | 3/4 |
| XE-050-3Y1X-* | 3 | WYE | 50 kA | 50/60 Hz | 208Y/120 V | 20 kA | 200 kA | 1000 | 700 | 600 | 700 | 3/4 |
| XE-100-3Y1X-* | 3 | WYE | 100 kA | 50/60 Hz | 208Y/120 V | 20 kA | 200 kA | 1200 | 700 | 700 | 700 | 3/4 |
| XE-050-3Y2X-* | 3 | WYE | 50 kA | 50/60 Hz | 480Y/277 V | 20 kA | 200 kA | 2000 | 1200 | 1200 | 1200 | 3/4 |
| XE-100-3Y2X-* | 3 | WYE | 100 kA | 50/60 Hz | 480Y/277 V | 20 kA | 200 kA | 2500 | 1200 | 1200 | 1200 | 3/4 |
| XE-050-3D1X-* | 3 | HI-LEG DELTA | 50 kA | 50/60 Hz | 240D/120 V | 20 kA | 200 kA | 1200/2000 | 800/1200 | 700/1200 | 700 | 3/4 |
| XE-100-3D1X-* | 3 | HI-LEG DELTA | 100 kA | 50/60 Hz | 240D/120 V | 20 kA | 200 kA | 1200/2000 | 800/1200 | 700/1200 | 700 | 3/4 |
| XE-050-3N4X-* | 3 | DELTA | 50 kA | 50/60 Hz | 480 V | 20 kA | 200 kA | 1800 | - | 1800 | - | 3/4 |
| XE-100-3N4X-* | 3 | DELTA | 100 kA | 50/60 Hz | 480 V | 20 kA | 200 kA | 2000 | - | 1800 | - | 3/4 |

K

Tested and Certified:
Type 2 SPDs (filter) = UL 1449, UL 1283,
CSA C22.2 No. 269.2-13, CSA C22.2 No. 8-13

Operating temperature range -40 to +150° F

Enclosure is rated to NEMA/UL Type 1, 2, 3, 3R, 3X, 4 and 4X

Type 2 = Permanently connected SPDs intended for installation on the load side of the service equipment overcurrent device; including SPDs located at the branch panel

Add on option code to catalog number

| Option Code | UL/CSA Type | Indicator LED | Audible Alarm | Dry Relay Contact | Electrical Noise Filter† |
|-------------|-------------|---------------|---------------|-------------------|--------------------------|
| C | 2 | • | | | • |
| D | 2 | • | • | • | • |

*Indicates Package and option code- C or D

† Advanced UL 1283 rated electrical noise filter

| | |
|-----------------------------------------|------------------|
| Technical..... | 426- 431 |
| Decimal Conversion Chart | 432 |
| Wire Size Charts..... | 433 |
| Wire Amperage Rating Chart | 434 - 435 |
| Torque Index | 436 |
| Torque Information..... | 437 |
| RoHS Compliance..... | 438 |
| Cross Reference Guide | 439 |



Technical Information

A brief summary of comparative properties of metals suitable for current carrying applications and required features of the connector are listed below in Table 1.

| Order | Metal | % Volume Conductivity | Relative Abundance earth's surface % |
|-------|-----------|-----------------------|--------------------------------------|
| 1. | Silver | 108.3 | |
| 2. | Copper | 100.0 | 0.088% |
| 3. | Gold | 73.4 | |
| 4. | Aluminum | 64.9 | 8.0% |
| 5. | Magnesium | 38.0 | 1.8% |

The commercial use of copper and aluminum for electrical application are obvious, in terms of economic justifications. The accelerated use of aluminum becomes even more obvious when realized that it requires twice the amount of copper by weight, to carry a specified amount of current. At the unit price per pound of prime metal it is readily seen why aluminum is increasing in electrical application.

As the next logical step, an examination of available alloys and forms of aluminum should be made to determine the optimum choice for the manufacture of electrical connectors. Please refer to Table 2

| Alloy | Form | Typical Yield Strength | Minimum Yield Strength | Elongation | % Conductivity |
|----------------|-----------|------------------------|------------------------|------------|----------------|
| 6061-T6 | Extrusion | 40-45,000 | 35,000 | 12 | 40 |
| 6063-T6 | Extrusion | 31,000 | 25,000 | 12 | 53 |
| Al. Mag. | Sand Cast | 22,000 | 22,000 | 12 | 25 |
| 356-T6 | Sand Cast | 24,000 | 24,000 | 3½ | 39 |
| AXS 679 (380A) | Die Cast | 21,000 | 21,000 | 3 | 25 |

During the initial analysis of these materials, reference was made to the experience over many years of the effect of stress on tensioned overhead conductors. It is well documented that in order to assure mechanical stability of these conductors, over long periods of time, it is necessary to design the line so that the maximum stress will not exceed 50% of the conductors rated breaking strength. In the case of aluminum conductors the alloy most commonly used is EC-H19 having a yield strength of 22,000 psi and a tensile strength of 24,000 psi. From the foregoing it is obvious that a maximum stress level of 12,000 psi representing 50% of ultimate tensile strength or approximately 55% of yield strength, will result in the conductor remaining mechanically stable throughout its life.

With this initial premise being established it was necessary to confirm whether or not a determinable stress limit could be effectively applied to the design of connectors. The method of testing used to confirm this premise is noted in detail in table 8.



Technical Information

Additional factors of design were recognized as necessary to achieve a stable and reliable connector. Requirements of aluminum connectors for use with aluminum or copper conductors.

- a. Adequate strength of the connector to prevent creep loss in the connection from exceeding the creep loss of the conductor.
- b. Strong enough clamping force (torque) to keep the connector operating temperature at a level below the operating temperature of the maximum size conductor.
- c. High enough conductivity to provide adequate efficiency (minimum of 40%).

To illustrate the significance of these requirements, Table 3 headed *Terminal life Cycle*, presents an examination of terminal temperature in relation to clamping force. The horizontal dotted line indicates the temperature of the conductor at maximum rise. The tightening characteristic curve shows a lowering of terminal temperature rise with an increased clamping force. Terminal temperature, measured in degrees centigrade, is used in our illustration as a measure of connector resistance. As the tightening characteristic curve approaches the dotted conductor temperature line at the same current value, the connector and conductor resistance approximate each other.

The curves labeled Relaxation Characteristic, merely indicate the anticipated progression a connector would follow to failure, once clamping force has been reduced to a level where terminal resistance can no longer be maintained at a low level. Point A on each curve represents that point where resistance is sufficiently high to cause an elevated operating temperature of the connector which will then progress to ultimate connector failure.

Proceeding with the assumption that stress limitation is a most critical factor in connector design it was then necessary to select and test the alloy materials which evidence the most favorable conductivity/yield strength/economic factors. The initial selection of aluminum alloy 6061-T6 has long since been determined to be the best available material from which to fabricate connectors for use with both aluminum and copper conductors.

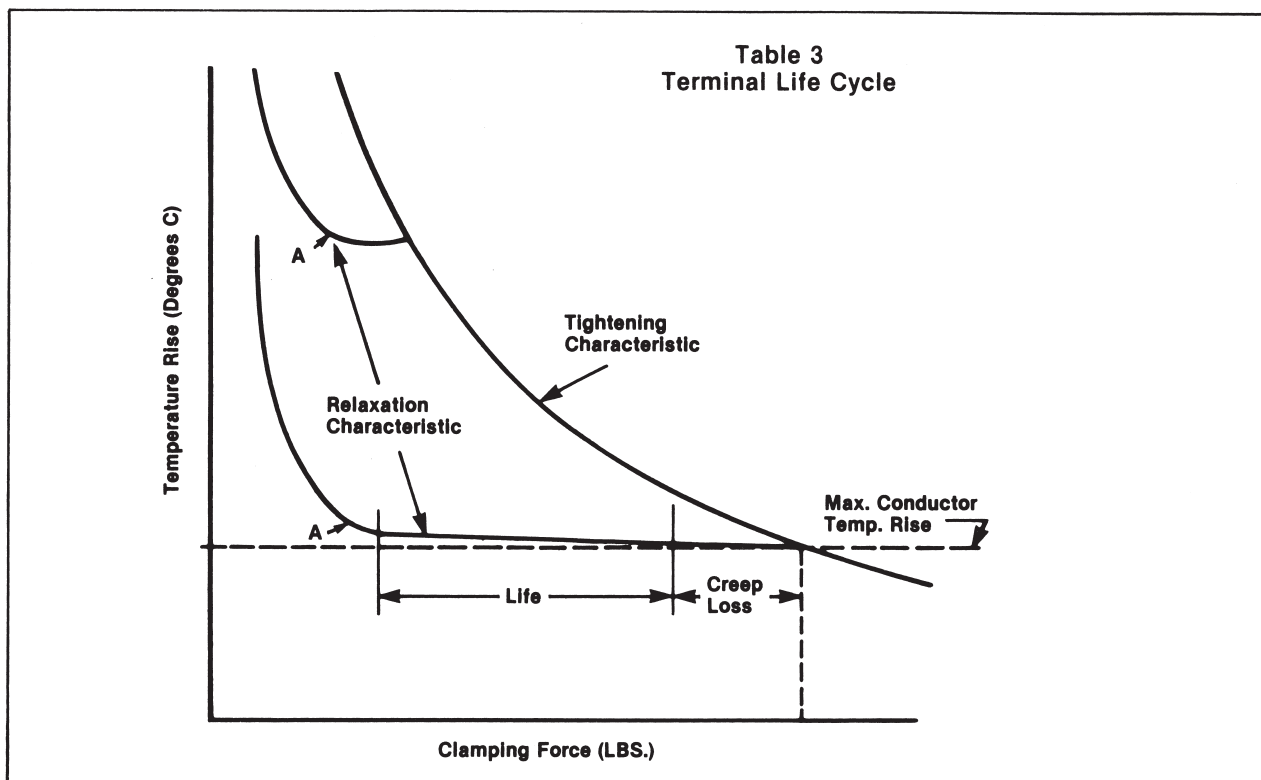

Technical Information

Before proceeding further a definition of terms used, to assure understanding of the basis for the conclusions reached later in the paper, are listed.

Physical Property of Aluminum

Tensile Strength

The maximum tensile load which a material is capable of withstanding under gradually and uniformly applied loading, divided by the original cross-sectional area in the minimum plane perpendicular to the direction of loading. Commonly the term is taken to mean the same as "ultimate tensile strength" or the less accurate "breaking strength."

Yield Strength

The stress at which material exhibits a specified permanent set. The value of set used for aluminum and its alloys is 0.002 inch per inch or 0.2%. For the aluminum alloys the yield strength in tension and compression are approximately the same.

Elongation

The increase in distance between two gage marks that results from stressing the specimen in tension to fracture. Please see table 5.

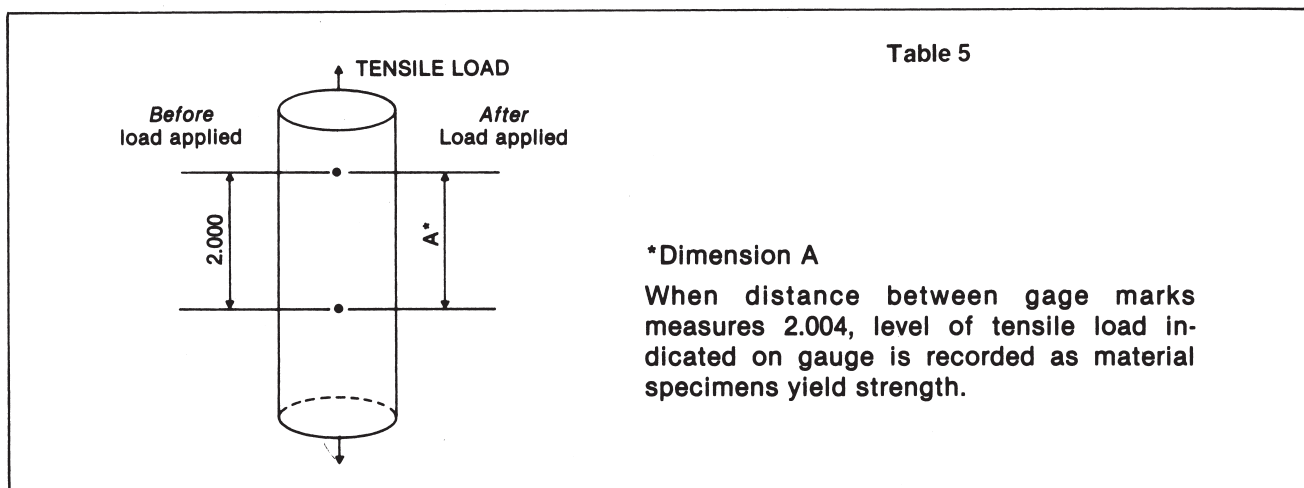

To record elongation, tensile loading is continually applied until specimen fractures, at which time two pieces are mated and distance between gage marks accurately measured. The resultant dimension divided by the original increment provides the value expressed in %, of the materials ability to stretch under load, or its elongation.

Elastic Limit

The stress value below which no permanent set or permanent deformation takes place; the highest stress which will permit return to original shape upon removal of force causing the stress.

Elasticity

The ability of a material to return to its original shape and size upon removal of a load below the elastic limit.

Creep

A precise unit of measure disclosing the increase in dimension of a unit specimen having a specified area =A, an applied force =W with resultant constant stress = $\frac{W}{A}$. The initial increment of measurement L, is effected by three factors resulting in amount of increase or creep, stress, time and temperature.

To determine and express the creep rate for a given specimen in terms of inches of creep, per inches of original gage length, per hour, the factors of stress and temperature must be maintained constant. A change in either or both, will result in a change in the creep rate.

Please refer to Tables 6 and 7.

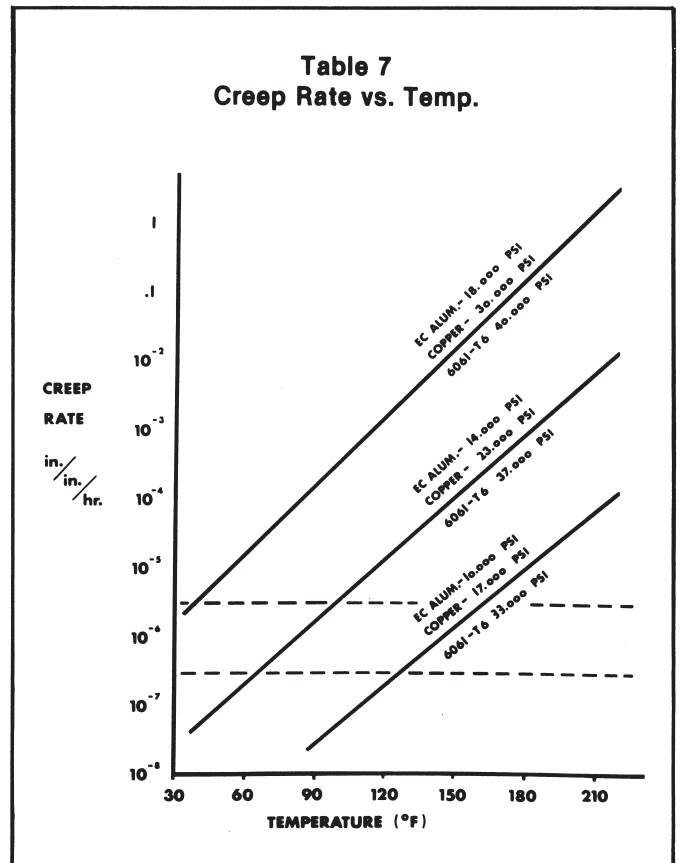
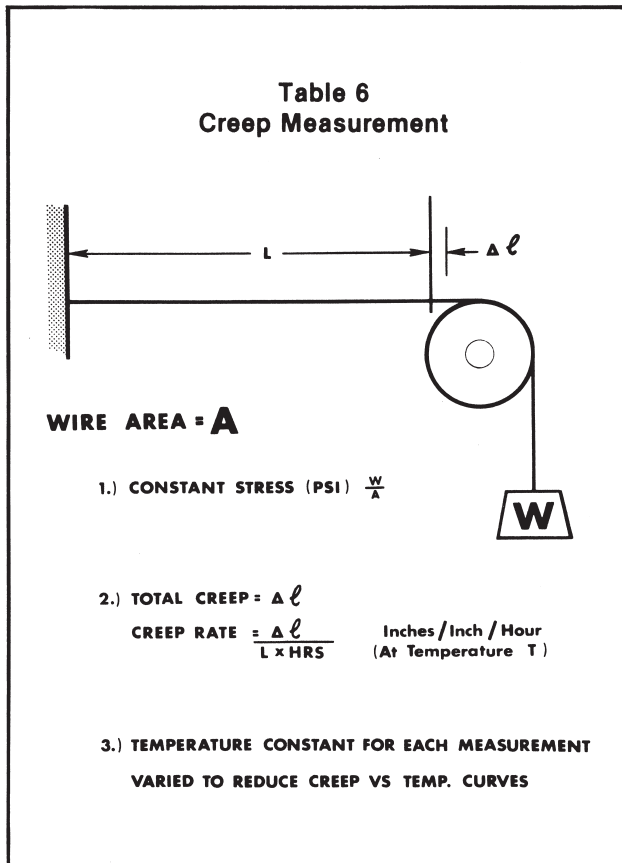

Cold Flow

As compared to Creep, cold flow has no units of measure. The best description of cold flow relating to application within the electrical industry, is an excessively high rate of creep i.e. normal creep rate static load condition would be expressed in a fraction of an inch per inch of length. Cold flow, conversely if possible to measure it in definable terms, would be expressed in terms of inches of movement per inch of length. Cold flow then can be expressed as movement of appreciable magnitude occurring at a stress level in a very short length of time at an ambient temperature. Neither time or temperature are critical in assessing the effecting force of cold flow.

It is significant to realize that it is an absolute necessity to have cold flow of the conductor within a bolted connector to develop the desired low resistance contact, required for electrical/mechanical stability of the connection. So is it necessary to have cold flow of both the conductor and connector in the making of a compression connection. In these two instances a mechanical union of the two components is made by means of an externally applied force to assure both electrical and mechanical reliability. In the case of a soldered or welded connection this component union is made metallurgically.

Creep Loss

The unit of measurement, expressed in % of the initially applied mechanical force to a connection, divided by the resultant measured force after the unit has been subjected to controlled loadings of temperature and time. This value is relatively easy to determine for bolted connectors by accurately measuring applied torque before and after applying control factors of time and temperature. The resultant loss of torque is the creep loss experienced within the connection assembly.

It is difficult and inaccurate to project anticipated creep loss within a compression assembly since there is no way of effecting a measurement of the initially applied force and the resultant force remaining on the connection after the mechanical or hydraulic compression tool is removed from the connector.

The maximum desired creep loss in a connector/conductor assembly stated, is that portion of the total creep component represented by the creep component of the conductor alone.



Technical Information

This brings us to the threshold of the discussion of design parameters used by nVent ILSCO in the manufacturer of aluminum connectors.

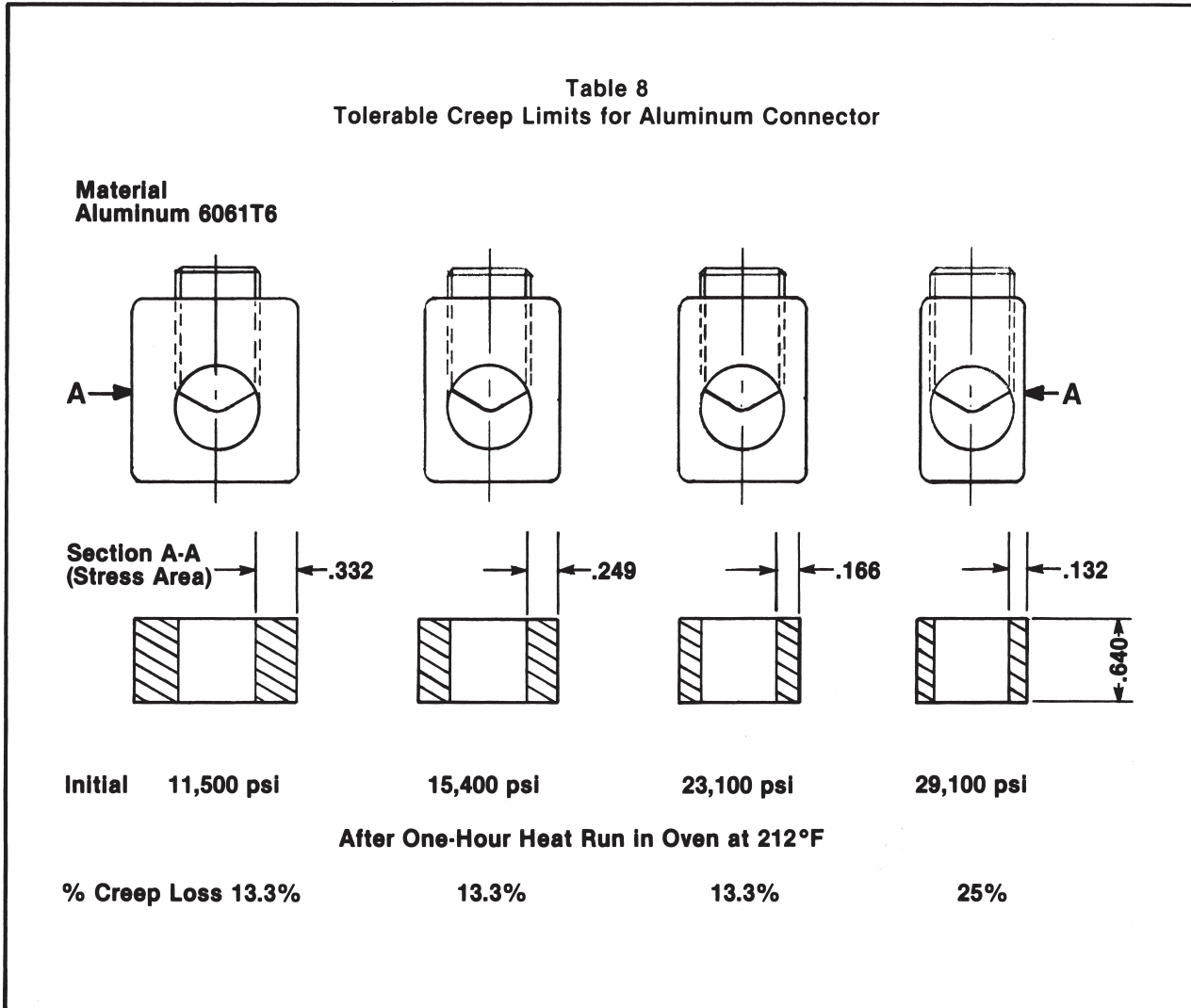

To best understand the importance of the function of creep components in a connection assembly, recall the definition of cold flow wherein it is stated that it is necessary to the formulation of an electrically/mechanically stable connection to have cold flow of the conductor. Since cold flow is by definition a high rate of creep and since creep occurs only where constant stress is applied; the connection will undergo creep movement as a result of load cycling. It is mandatory that the connector be so designed that all creep within the assembly occur in the conductor.

The determination of tolerable creep limits for aluminum connector design were established through the test described below and pictured in Table 8

This test established the maximum stress which can be imposed on an aluminum connector made from Alloy 6061-T6 as being 23,000 psi which is approximately 1/2 typical yield strength. The value of creep loss for the first three connectors were identical; 13.3% whereas the fourth exhibited a 25% creep loss. The explanation is simply that the loads applied to the section modulus of each of the first three test connectors resulted in a stress level below the elastic limit of the material and thereby causing no creep movement in the connector. The conductor on the other hand must be physically moved, and this conductor movement resulted in a redistribution of strand displacement and resultant redistribution of load. The 13.3% creep loss therefore can be stated as being that movement occurring within the conductor.

Technical Information

The Fourth sample, however, evidenced in higher creep loss, resulting from creep in the conductor and the connector since the connector was stressed beyond its elastic limit and contributed to the total creep of the assembly.

The confirmation by actual test of this limitation of stress to 1/2 the materials yield strength has been utilized in the design of all connectors manufactured by nVent ILSCO.

Preparation of wire

When an aluminum cable is installed, certain procedures should be followed to insure a good connection.

1. The insulation should be stripped with a whittling motion to prevent the cable from being nicked.
2. The cable should then be cleaned with a wire brush. This removes the oxides from the surface of the conductor.
3. In many cases, an oxide inhibitor is applied to the conductor immediately prior to installation. However, this is not absolutely necessary.
4. For mechanical connectors, the set screw should be tightened. After a few seconds, the set screw should be retightened to insure a good connection. For compression connectors, the lug should be crimped around the conductor using the proper tool.

Decimal Conversion Chart

MILLIMETER / DECIMAL / FRACTION CONVERSION CHART

| Milli-meter | Decimal | Fraction (inches) | Milli-meter | Decimal | Fraction (inches) | Milli-meter | Decimal | Fraction (inches) | Milli-meter | Decimal | Fraction (inches) | Milli-meter | Decimal | Fraction (inches) |
|-------------|---------|-------------------|-------------|---------|-------------------|-------------|---------|-------------------|-------------|---------|-------------------|-------------|---------|-------------------|
| 0.1 | .0039 | | 5.159 | .2031 | 13/64 | 10.2 | .4016 | | 15.3 | .6024 | | 20.3 | .7992 | |
| 0.2 | .0079 | | 5.2 | .2047 | | 10.3 | .4055 | | 15.4 | .6063 | | 20.4 | .8031 | |
| 0.3 | .0118 | | 5.3 | .2087 | | 10.319 | .4063 | 13/32 | 15.478 | .6094 | 39/64 | 20.5 | .8071 | |
| 0.397 | .0156 | 1/64 | 5.4 | .2126 | | 10.4 | .4094 | | 15.5 | .6102 | | 20.6 | .8110 | |
| 0.4 | .0157 | | 5.5 | .2165 | | 10.5 | .4134 | | 15.6 | .6142 | | 20.638 | .8125 | 13/16 |
| 0.5 | .0197 | | 5.556 | .2188 | 7/32 | 10.6 | .4173 | | 15.7 | .6181 | | 20.7 | .8150 | |
| 0.6 | .0236 | | 5.6 | .2205 | | 10.7 | .4213 | | 15.8 | .6220 | | 20.8 | .8189 | |
| 0.7 | .0276 | | 5.7 | .2244 | | 10.716 | .4219 | 27/64 | 15.875 | .6250 | 5/8 | 20.9 | .8228 | |
| 0.794 | .0313 | 1/32 | 5.8 | .2283 | | 10.8 | .4252 | | 15.9 | .6260 | | 21.0 | .8268 | |
| 0.8 | .0315 | | 5.9 | .2323 | | 10.9 | .4291 | | 16.0 | .6299 | | 21.034 | .8281 | 53/64 |
| 0.9 | .0354 | | 5.953 | .2344 | 15/64 | 11.0 | .4331 | | 16.1 | .6339 | | 21.1 | .8307 | |
| 1.0 | .0394 | | 6.0 | .2362 | | 11.1 | .4370 | | 16.2 | .6378 | | 21.2 | .8346 | |
| 1.1 | .0433 | | 6.1 | .2402 | | 11.113 | .4375 | 7/16 | 16.272 | .6406 | 41/64 | 21.3 | .8386 | |
| 1.191 | .0469 | 3/64 | 6.2 | .2441 | | 11.2 | .4409 | | 16.3 | .6417 | | 21.4 | .8425 | |
| 1.2 | .0472 | | 6.3 | .2480 | | 11.3 | .4449 | | 16.4 | .6457 | | 21.431 | .8438 | 27/32 |
| 1.3 | .0512 | | 6.350 | .2500 | 1/4 | 11.4 | .4488 | | 16.5 | .6496 | | 21.5 | .8465 | |
| 1.4 | .0551 | | 6.4 | .2520 | | 11.5 | .4528 | | 16.6 | .6535 | | 21.6 | .8504 | |
| 1.5 | .0591 | | 6.5 | .2559 | | 11.509 | .4531 | 29/64 | 16.669 | .6563 | 21/32 | 21.7 | .8543 | |
| 1.588 | .0625 | 1/16 | 6.6 | .2598 | | 11.6 | .4567 | | 16.7 | .6575 | | 21.8 | .8583 | |
| 1.6 | .0630 | | 6.7 | .2638 | | 11.7 | .4606 | | 16.8 | .6614 | | 21.828 | .8594 | 55/64 |
| 1.7 | .0669 | | 6.747 | .2656 | 17/64 | 11.8 | .4646 | | 16.9 | .6654 | | 21.9 | .8622 | |
| 1.8 | .0709 | | 6.8 | .2677 | | 11.9 | .4685 | | 17.0 | .6693 | | 22.0 | .8661 | |
| 1.9 | .0748 | | 6.9 | .2717 | | 11.906 | .4688 | 15/32 | 17.066 | .6719 | 43/64 | 22.1 | .8701 | |
| 1.984 | .0781 | 5/64 | 7.0 | .2756 | | 12.0 | .4724 | | 17.1 | .6732 | | 22.2 | .8740 | |
| 2.0 | .0787 | | 7.1 | .2795 | | 12.1 | .4764 | | 17.2 | .6772 | | 22.225 | .8750 | 7/8 |
| 2.1 | .0827 | | 7.144 | .2813 | 9/32 | 12.2 | .4803 | | 17.3 | .6811 | | 22.3 | .8780 | |
| 2.2 | .0866 | | 7.2 | .2835 | | 12.3 | .4843 | | 17.4 | .6850 | | 22.4 | .8819 | |
| 2.3 | .0906 | | 7.3 | .2874 | | 12.303 | .4844 | 31/64 | 17.463 | .6875 | 11/16 | 22.5 | .8858 | |
| 2.381 | .0938 | 3/32 | 7.4 | .2913 | | 12.4 | .4882 | | 17.5 | .6890 | | 22.6 | .8898 | |
| 2.4 | .0945 | | 7.5 | .2953 | | 12.5 | .4921 | | 17.6 | .6929 | | 22.622 | .8906 | 57/64 |
| 2.5 | .0984 | | 7.541 | .2969 | 19/64 | 12.6 | .4961 | | 17.7 | .6968 | | 22.7 | .8937 | |
| 2.6 | .1024 | | 7.6 | .2992 | | 12.7 | .5000 | 1/2 | 17.8 | .7008 | | 22.8 | .8976 | |
| 2.7 | .1063 | | 7.7 | .3031 | | 12.8 | .5039 | | 17.859 | .7031 | 45/64 | 22.9 | .9016 | |
| 2.778 | .1094 | 7/64 | 7.8 | .3071 | | 12.9 | .5079 | | 17.9 | .7047 | | 23.0 | .9055 | |
| 2.8 | .1102 | | 7.9 | .3110 | | 13.0 | .5118 | | 18.0 | .7087 | | 23.019 | .9063 | 29/32 |
| 2.9 | .1142 | | 7.938 | .3125 | 5/16 | 13.097 | .5156 | 33/64 | 18.1 | .7126 | | 23.1 | .9094 | |
| 3.0 | .1181 | | 8.0 | .3150 | | 13.1 | .5157 | | 18.2 | .7165 | | 23.2 | .9134 | |
| 3.1 | .1220 | | 8.1 | .3189 | | 13.2 | .5197 | | 18.256 | .7188 | 23/32 | 23.3 | .9173 | |
| 3.175 | .1250 | 1/8 | 8.2 | .3228 | | 13.3 | .5236 | | 18.3 | .7205 | | 23.4 | .9213 | |
| 3.2 | .1260 | | 8.3 | .3268 | | 13.4 | .5276 | | 18.4 | .7244 | | 23.416 | .9219 | 59/64 |
| 3.3 | .1299 | | 8.334 | .3281 | 21/64 | 13.494 | .5313 | 17/32 | 18.5 | .7283 | | 23.5 | .9252 | |
| 3.4 | .1339 | | 8.4 | .3307 | | 13.5 | .5315 | | 18.6 | .7323 | | 23.6 | .9291 | |
| 3.5 | .1378 | | 8.5 | .3346 | | 13.6 | .5354 | | 18.653 | .7344 | 47/64 | 23.7 | .9331 | |
| 3.572 | .1406 | 9/64 | 8.6 | .3386 | | 13.7 | .5394 | | 18.7 | .7362 | | 23.8 | .9370 | |
| 3.6 | .1417 | | 8.7 | .3425 | | 13.8 | .5433 | | 18.8 | .7402 | | 23.813 | .9375 | 15/16 |
| 3.7 | .1457 | | 8.731 | .3438 | 11/32 | 13.891 | .5469 | 35/64 | 18.9 | .7441 | | 23.9 | .9409 | |
| 3.8 | .1496 | | 8.8 | .3465 | | 13.9 | .5472 | | 19.0 | .7480 | | 24.0 | .9449 | |
| 3.9 | .1535 | | 8.9 | .3504 | | 14.0 | .5512 | | 19.050 | .7500 | 3/4 | 24.1 | .9488 | |
| 3.969 | .1563 | 5/32 | 9.0 | .3543 | | 14.1 | .5551 | | 19.1 | .7520 | | 24.2 | .9528 | |
| 4.0 | .1575 | | 9.1 | .3583 | | 14.2 | .5591 | | 19.2 | .7559 | | 24.209 | .9531 | 61/64 |
| 4.1 | .1614 | | 9.128 | .3594 | 23/64 | 14.288 | .5625 | 9/16 | 19.3 | .7598 | | 24.3 | .9567 | |
| 4.2 | .1654 | | 9.2 | .3622 | | 14.3 | .5630 | | 19.4 | .7638 | | 24.4 | .9606 | |
| 4.3 | .1693 | | 9.3 | .3661 | | 14.4 | .5669 | | 19.447 | .7656 | 49/64 | 24.5 | .9646 | |
| 4.366 | .1719 | 11/64 | 9.4 | .3701 | | 14.5 | .5709 | | 19.5 | .7677 | | 24.6 | .9685 | |
| 4.4 | .1732 | | 9.5 | .3740 | | 14.6 | .5748 | | 19.6 | .7717 | | 24.606 | .9688 | 31/32 |
| 4.5 | .1772 | | 9.525 | .3750 | 3/8 | 14.684 | .5781 | 37/64 | 19.7 | .7756 | | 24.7 | .9724 | |
| 4.6 | .1811 | | 9.6 | .3780 | | 14.7 | .5787 | | 19.8 | .7795 | | 24.8 | .9764 | |
| 4.7 | .1850 | | 9.7 | .3819 | | 14.8 | .5827 | | 19.844 | .7813 | 25/32 | 24.9 | .9803 | |
| 4.763 | .1875 | 3/16 | 9.8 | .3858 | | 14.9 | .5866 | | 19.9 | .7835 | | 25.0 | .9843 | |
| 4.8 | .1890 | | 9.9 | .3898 | | 15.0 | .5906 | | 20.0 | .7874 | | 25.003 | .9844 | 63/64 |
| 4.9 | .1929 | | 9.922 | .3906 | 25/64 | 15.081 | .5938 | 19/32 | 20.1 | .7913 | | 25.1 | .9882 | |
| 5.0 | .1969 | | 10.0 | .3937 | | 15.1 | .5945 | | 20.2 | .7953 | | 25.2 | .9921 | |
| 5.1 | .2008 | | 10.1 | .3976 | | 15.2 | .5984 | | 20.241 | .7969 | 51/64 | 25.3 | .9961 | |
| | | | | | | | | | | | | 25.400 | 1.0000 | 1 |

Wire Size Charts

AWG VS. METRIC WIRE SIZES

| Circ. Mils | Equivalent Circ. Mils | Awg. Size | Metric Wire Size mm ² | Stranding/ Wire Diameter Per Strand | | Approximate Overall Diameter | | Circ. Mils | Equivalent Circ. Mils | Awg. Size | Metric Wire Size mm ² | Stranding/ Wire Diameter Per Strand | | Approximate Overall Diameter | |
|------------|-----------------------|-----------|----------------------------------|-------------------------------------|---------|------------------------------|------|------------|-----------------------|-----------|----------------------------------|-------------------------------------|----------|------------------------------|------|
| | | | | in | mm | in | mm | | | | | in | mm | | |
| - | 937 | - | 0.50 | 1/.032 | 1/1.813 | .032 | 0.81 | 83690 | - | 1 | - | 19/.0664 | 19/1.69 | .332 | 8.43 |
| 1020 | - | 20 | - | 7/.0121 | 7/.030 | .036 | 0.91 | - | 98680 | - | 50 | 19/.073 | 19/1.85 | .365 | 9.27 |
| - | 1480 | - | 0.75 | 1/.039 | 1/.991 | .039 | 0.99 | 105600 | - | 1/0 | - | 19/.0745 | 19/1.89 | .373 | 9.46 |
| 1620 | - | 18 | - | 1/.0403 | 1/1.02 | .040 | 1.02 | 133100 | - | 2/0 | - | 19/.0837 | 19/2.13 | .419 | 10.6 |
| 1620 | - | 18 | - | 7/.0152 | 7/.386 | .046 | 1.16 | - | 138100 | - | 70 | 19/.086 | 19/2.18 | .430 | 10.9 |
| - | 1974 | - | 1.0 | 1/.045 | 1/1.14 | .045 | 1.14 | 167800 | - | 3/0 | - | 19/.094 | 19/2.39 | .470 | 11.9 |
| - | 1974 | - | 1.0 | 7/.017 | 7/.432 | .051 | 1.30 | 167800 | - | 3/0 | - | 37/.0673 | 37/1.71 | .471 | 12.0 |
| 2580 | - | 16 | - | 1/.0508 | 1/1.29 | .051 | 1.29 | - | 187500 | - | 95 | 19/.101 | 19/2.57 | .505 | 12.8 |
| 2580 | - | 16 | - | 7/.0192 | 7/.488 | .058 | 1.46 | - | 187500 | - | 95 | 37/.072 | 37/1.83 | .504 | 12.8 |
| - | 2960 | - | 1.5 | 1/.055 | 1/1.40 | .055 | 1.40 | 211600 | - | 4/0 | - | 19/.1055 | 19/2.68 | .528 | 13.4 |
| - | 2960 | - | 1.5 | 7/.021 | 7/.533 | .063 | 1.60 | - | 237.8 kcmil | - | 120 | 37/.081 | 37/2.06 | .567 | 14.4 |
| 4110 | - | 14 | - | 1/.0641 | 1/1.63 | .064 | 1.63 | 250 kcmil | - | - | - | 37/.0822 | 37/2.09 | .575 | 14.6 |
| 4110 | - | 14 | - | 7/.0242 | 7/.615 | .073 | 1.84 | 300 kcmil | - | - | - | 37/.090 | 37/2.29 | .630 | 16.0 |
| - | 4934 | - | 2.5 | 1/.071 | 1/1.80 | .071 | 1.80 | 350 kcmil | - | - | - | 37/.0973 | 37/2.47 | .681 | 17.3 |
| - | 4934 | - | 2.5 | 7/.027 | 7/.686 | .081 | 2.06 | - | 365.1 kcmil | - | 185 | 37/.100 | 37/2.54 | .700 | 17.8 |
| 6530 | - | 12 | - | 1/.0808 | 1/2.05 | .081 | 2.05 | 400 kcmil | - | - | - | 37/.104 | 37/2.64 | .728 | 18.5 |
| 6530 | - | 12 | - | 7/.0305 | 7/.775 | .092 | 2.32 | - | 473.6 kcmil | - | 240 | 37/.114 | 37/2.90 | .798 | 20.3 |
| - | 7894 | - | 4 | 1/.089 | 1/2.26 | .089 | 2.26 | - | 473.6 kcmil | - | 240 | 61/.089 | 61/2.26 | .801 | 20.3 |
| - | 7894 | - | 4 | 7/.034 | 7/.864 | .102 | 2.59 | 500 kcmil | - | - | - | 37/.1162 | 37/2.95 | .813 | 20.7 |
| 10380 | - | 10 | - | 1/.1019 | 1/2.59 | .102 | 2.59 | 500 kcmil | - | - | - | 61/.0905 | 61/2.30 | .814 | 20.7 |
| 10380 | - | 10 | - | 7/.0385 | 7/.978 | .116 | 2.93 | - | 592.1 kcmil | - | 300 | 61/.099 | 61/2.51 | .891 | 22.6 |
| - | 11840 | - | 6 | 1/.109 | 1/2.77 | .109 | 2.77 | 600 kcmil | - | - | - | 61/.0992 | 61/2.52 | .893 | 22.7 |
| - | 11840 | - | 6 | 7/.042 | 7/1.07 | .126 | 3.21 | 700 kcmil | - | - | - | 61/.1071 | 61/2.72 | .964 | 24.5 |
| 13090 | - | 9 | - | 1/.1144 | 1/2.91 | .114 | 2.91 | 750 kcmil | - | - | - | 61/.1109 | 61/2.82 | .998 | 25.4 |
| 13090 | - | 9 | - | 7/.0432 | 7/1.10 | .130 | 3.30 | 750 kcmil | - | - | - | 91/.0908 | 91/2.31 | .999 | 25.4 |
| 16510 | - | 8 | - | 1/.1285 | 1/3.26 | .128 | 3.26 | - | 789.4 kcmil | - | 400 | 61/.114 | 61/2.90 | 1.026 | 26.1 |
| 16510 | - | 8 | - | 7/.0486 | 7/1.23 | .146 | 3.70 | 800 kcmil | - | - | - | 61/.1145 | 61/2.91 | 1.031 | 26.2 |
| - | 19740 | - | 10 | 1/.141 | 1/3.58 | .141 | 3.58 | 800 kcmil | - | - | - | 91/.0938 | 91/2.38 | 1.032 | 26.2 |
| - | 19740 | - | 10 | 7/.054 | 7/1.37 | .162 | 4.12 | 1000 kcmil | 986.8 kcmil | - | 500 | 61/.1280 | 61/3.25 | 1.152 | 29.3 |
| 20820 | - | 7 | - | 1/.1443 | 1/3.67 | .144 | 3.67 | 1000 kcmil | - | - | - | 91/.1048 | 91/2.66 | 1.153 | 29.3 |
| 20820 | - | 7 | - | 7/.0545 | 7/1.38 | .164 | 4.15 | - | 1233.7 kcmil | - | 625 | 91/.117 | 91/2.97 | 1.287 | 32.7 |
| 26240 | - | 6 | - | 1/.162 | 1/4.11 | .162 | 4.11 | 1250 kcmil | - | - | - | 91/.1172 | 91/2.98 | 1.289 | 32.7 |
| 26240 | - | 6 | - | 7/.0612 | 7/1.55 | .184 | 4.66 | 1250 kcmil | - | - | - | 127/.0992 | 127/2.52 | 1.290 | 32.8 |
| - | 31580 | - | 16 | 7/.068 | 7/1.73 | .204 | 5.18 | 1500 kcmil | - | - | - | 91/.1284 | 91/3.26 | 1.412 | 35.9 |
| 33090 | - | 5 | - | 7/.0688 | 7/1.75 | .206 | 5.24 | 1500 kcmil | - | - | - | 127/.1087 | 127/2.76 | 1.413 | 35.9 |
| 41740 | - | 4 | - | 7/.0772 | 7/1.96 | .232 | 5.88 | - | 1578.8 kcmil | - | 800 | 91/.132 | 91/3.35 | 1.452 | 36.9 |
| - | 49340 | - | 25 | 7/.085 | 7/2.16 | .255 | 6.48 | - | 1973.5 kcmil | - | 1000 | 91/.147 | 91/3.73 | 1.617 | 41.1 |
| - | 49340 | - | 25 | 19/.052 | 19/1.32 | .260 | 6.60 | 2000 kcmil | - | - | - | 127/.1255 | 127/3.19 | 1.632 | 41.5 |
| 52620 | - | 3 | - | 7/.0867 | 7/2.20 | .260 | 6.61 | 2000 kcmil | - | - | - | 169/.1088 | 169/2.76 | 1.632 | 41.5 |
| 66360 | - | 2 | - | 7/.0974 | 7/2.47 | .292 | 7.42 | - | - | - | - | - | - | - | - |
| - | 69070 | - | 35 | 7/.100 | 7/2.54 | .300 | 7.62 | - | - | - | - | - | - | - | - |
| - | 69070 | - | 35 | 19/.061 | 19/1.55 | .305 | 7.75 | - | - | - | - | - | - | - | - |

DIESEL LOCOMOTIVE AND CAR WIRING CABLE

| Conductor Stranding | Approx. Size Awg | Circular Mil Area | Conductor Diameter Inches |
|---------------------|------------------|-------------------|---------------------------|
| 19/.0117 | 16 | 2601 | .060 |
| 19/27 | 14 | 3831 | .096 |
| 19/25 | 12 | 6088 | .116 |
| 27/24 | 10 | 10910 | .146 |
| 37/24 | 8 | 14950 | .166 |
| 61/24 | 6 | 24640 | .226 |
| 91/24 | 5 | 36760 | .256 |
| 105/24 | 4 | 42420 | .286 |
| 125/24 | 3 | 50500 | .300 |
| 150/24 | 2 | 60600 | .366 |
| 225/24 | 1 | 90900 | .424 |
| 275/24 | 1/0 | 111100 | .454 |
| 325/24 | 2/0 | 131300 | .494 |
| 450/24 | 3/0 | 181800 | .604 |
| 550/24 | 4/0 | 222200 | .634 |
| 650/24 | 262.6 | 262600 | .712 |
| 775/24 | 313.1 | 313100 | .792 |
| 925/24 | 373.7 | 373700 | .852 |
| 1100/24 | 444.4 | 444400 | .922 |
| 1325/24 | 535.3 | 535300 | 1.022 |
| 1600/24 | 646.4 | 646400 | 1.122 |
| 1925/24 | 777.7 | 777700 | 1.182 |
| 2300/24 | 929.2 | 929200 | 1.292 |
| 2750/24 | 1111.0 | 1111000 | 1.43 |



Amperage Rating

310.15

ARTICLE 310 — CONDUCTORS FOR GENERAL WIRING

Table 310.15(B)(16) (formerly Table 310.16) Allowable Ampacities of Insulated Conductors Rated Up to and Including 2000 Volts, 60°C Through 90°C (140°F Through 194°F), Not More Than Three Current-Carrying Conductors in Raceway, Cable, or Earth (Directly Buried), Based on Ambient Temperature of 30°C (86°F)*

| Size AWG or kcmil | Temperature Rating of Conductor [See Table 310.104(A).] | | | | | | Size AWG or kcmil |
|-------------------|---------------------------------------------------------|-------------------------------------------|----------------------------------------------------------------------------------------------------------|----------------------------------|---------------------------------------|-------------------------------------------------------------------------------------------|-------------------|
| | 60°C (140°F) | 75°C (167°F) | 90°C (194°F) | 60°C (140°F) | 75°C (167°F) | 90°C (194°F) | |
| | Types TW, UF | Types RHW, THHW, THW, THWN, XHHW, USE, ZW | Types TBS, SA, SIS, FEP, FEPB, MI, RHH, RHW-2, THHN, THHW, THW-2, THWN-2, USE-2, XHH, XHHW, XHHW-2, ZW-2 | Types TW, UF | Types RHW, THHW, THW, THWN, XHHW, USE | Types TBS, SA, SIS, THHN, THHW, THW-2, THWN-2, RHH, RHW-2, USE-2, XHH, XHHW, XHHW-2, ZW-2 | |
| | COPPER | | | ALUMINUM OR COPPER-CLAD ALUMINUM | | | |
| 18** | — | — | 14 | — | — | — | — |
| 16** | — | — | 18 | — | — | — | — |
| 14** | 15 | 20 | 25 | — | — | — | — |
| 12** | 20 | 25 | 30 | 15 | 20 | 25 | 12** |
| 10** | 30 | 35 | 40 | 25 | 30 | 35 | 10** |
| 8 | 40 | 50 | 55 | 35 | 40 | 45 | 8 |
| 6 | 55 | 65 | 75 | 40 | 50 | 55 | 6 |
| 4 | 70 | 85 | 95 | 55 | 65 | 75 | 4 |
| 3 | 85 | 100 | 115 | 65 | 75 | 85 | 3 |
| 2 | 95 | 115 | 130 | 75 | 90 | 100 | 2 |
| 1 | 110 | 130 | 145 | 85 | 100 | 115 | 1 |
| 1/0 | 125 | 150 | 170 | 100 | 120 | 135 | 1/0 |
| 2/0 | 145 | 175 | 195 | 115 | 135 | 150 | 2/0 |
| 3/0 | 165 | 200 | 225 | 130 | 155 | 175 | 3/0 |
| 4/0 | 195 | 230 | 260 | 150 | 180 | 205 | 4/0 |
| 250 | 215 | 255 | 290 | 170 | 205 | 230 | 250 |
| 300 | 240 | 285 | 320 | 195 | 230 | 260 | 300 |
| 350 | 260 | 310 | 350 | 210 | 250 | 280 | 350 |
| 400 | 280 | 335 | 380 | 225 | 270 | 305 | 400 |
| 500 | 320 | 380 | 430 | 260 | 310 | 350 | 500 |
| 600 | 350 | 420 | 475 | 285 | 340 | 385 | 600 |
| 700 | 385 | 460 | 520 | 315 | 375 | 425 | 700 |
| 750 | 400 | 475 | 535 | 320 | 385 | 435 | 750 |
| 800 | 410 | 490 | 555 | 330 | 395 | 445 | 800 |
| 900 | 435 | 520 | 585 | 355 | 425 | 480 | 900 |
| 1000 | 455 | 545 | 615 | 375 | 445 | 500 | 1000 |
| 1250 | 495 | 590 | 665 | 405 | 485 | 545 | 1250 |
| 1500 | 525 | 625 | 705 | 435 | 520 | 585 | 1500 |
| 1750 | 545 | 650 | 735 | 455 | 545 | 615 | 1750 |
| 2000 | 555 | 665 | 750 | 470 | 560 | 630 | 2000 |

*Refer to 310.15(B)(2) for the ampacity correction factors where the ambient temperature is other than 30°C (86°F).

**Refer to 240.4(D) for conductor overcurrent protection limitations.



Copyright 2012 National Fire Protection Association (NFPA). Licensed, by agreement, for individual use and single download on May 4, 2012 to Cheryl Hennessy of nVent ILSCO. No other reproduction or transmission in any form permitted without written permission of NFPA. For inquires or to report unauthorized use, contact licensing@nfpa.org.

Amperage Rating



Table 310.15(B)(3)(a) Adjustment Factors for More Than Three Current-Carrying Conductors in a Raceway or Cable

| Number of Conductors¹ | Percent of Values in Table 310.15(B)(16) through Table 310.15(B)(19) as Adjusted for Ambient Temperature if Necessary |
|-----------------------------------------|------------------------------------------------------------------------------------------------------------------------------|
| 4-6 | 80 |
| 7-9 | 70 |
| 10-20 | 50 |
| 21-30 | 45 |
| 31-40 | 40 |
| 41 and above | 35 |

¹Number of conductors is the total number of conductors in the raceway or cable adjusted in accordance with 310.15(B)(5) and (6).

Torque Index

INFORMATION SHEET TIGHTENING TORQUE VALUES FOR ILSCO MECHANICAL SCREW CONNECTORS

| WIRE SIZE | TIGHTENING TORQUE IN INCH POUNDS | |
|-----------|--------------------------------------------------------------------------------------------------------------------|---------------------------------------------------------------------------------------------------------------|
| | SCREW DRIVER  COMBO SLOTTED | EXTERNAL DRIVE WRENCH  |
| 14 AWG | 35 | 75 |
| 12 AWG | 35 | 75 |
| 10 AWG | 35 | 75 |
| 8 AWG | 40 | 75 |
| 6 AWG | 45 | 110 |
| 4 AWG | 45 | 110 |
| 2 AWG | 50 | 150 |
| 1 AWG | 50 | 150 |
| 1/0 AWG | 50 | 180 |
| 2/0 AWG | 50 | 180 |
| 3/0 AWG | | 250 |
| 4/0 AWG | | 250 |
| 250kcmil | | 325 |
| 350kcmil | | 325 |
| 500kcmil | | 375 |
| 600kcmil | | 375 |
| 700kcmil | | 375 |
| 750kcmil | | 375 |
| 800kcmil | | 500 |
| 1000kcmil | | 500 |

FORM 1
Revised 9-21-2015

INFORMATION SHEET TIGHTENING TORQUE VALUES FOR ILSCO SOCKETHEAD SCREW CONNECTORS

| INTERNAL SOCKET SIZE ACROSS FLATS INCHES | TIGHTENING TORQUE IN INCH POUNDS  INTERNAL SOCKET |
|------------------------------------------------|--------------------------------------------------------------------------------------------------------------------------------------------|
| 1/8 | 45 |
| 5/32 | 100 |
| 3/16 | 120 |
| 7/32 | 150 |
| 1/4 | 200 |
| 5/16 | 275 |
| 3/8 | 375 |
| 1/2 | 500 |
| 9/16 | 600 |

FORM 1
Revised 9-21-2015

TIGHTENING TORQUE FOR CONNECTING HARDWARE

| SCREW OR BOLT SIZE | | TIGHTENING TORQUE | |
|--------------------|-------------------------|-------------------|-----------------|
| METRIC | SAE | N·m | (lbf·ft) |
| - | No. 8 or smaller | 2 | (1.5) 18 |
| - | No. 10 | 3 | (2.0) 24 |
| M6 | 1/4 | 8 | (6) 72 |

Please reference the instruction sheet included with your connector for specific torque values.

All wire sizes, unless noted otherwise, are American Wire Gauge (AWG)

* Torque information included with product supersedes this page.

Torque Information

Table I shows the recommended tightening torques for silicon bronze, stainless steel, galvanized steel and aluminum alloy hardware. The shaded portion represents torques presently recommended by NEMA-CC1-1984 specification.

**TABLE I
TIGHTENING TORQUES**

| Bolt Diameter | Nominal Torque Values | | | |
|---------------|-----------------------------------------------|-----------|-----------------------------|-----------|
| | Silicon Bronze, Galvanized or Stainless Steel | | Aluminum Alloy (Lubricated) | |
| | Ft.-Lbs. | Inch-Lbs. | Ft.-Lbs. | Inch-Lbs. |
| 5/16-18 | 15 | 180 | - | - |
| 3/8-16 | 20 | 240 | 14 | 168 |
| 1/2-13 | 40 | 480 | 25 | 300 |
| 5/8-11 | 55 | 660 | 40 | 480 |
| 3/4-10 | 80 | 960 | 70 | 840 |

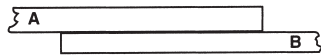

**TABLE II
METHODS OF JOINING BUS BARS**

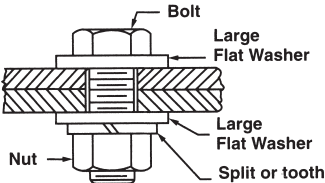
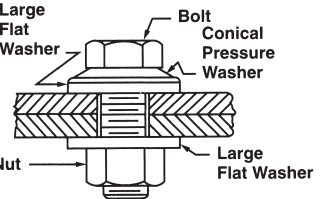
| If "A" Bar is and If "B" Bar is | Copper Copper | Aluminum Copper | Steel Copper | Aluminum Aluminum | Steel Aluminum |
|--------------------------------------------------------------------------------------------------------------------------------|-------------------------------------------|------------------------------------------------------------------------------------------------------------------------|-------------------------------------------|---------------------------------------------------------------------------------------------------------------------------------------|------------------------------------------------------------------------------------------------------|
| Hard Drawn Bus such as aluminum alloy.  | (1) Silicon Bronze (2) Stainless Steel | (1) Silicon Bronze (2) Aluminum (3) Stainless Steel | (1) Silicon Bronze (2) Stainless Steel | (1) Aluminum (2) Stainless Steel (3) Silicon Bronze, Plated | (1) Aluminum (2) Stainless Steel |
| Soft Drawn Bus such as EC-H13 Aluminum.  | (1) Silicon Bronze (2) Stainless Steel | (1) Silicon Bronze (2) Aluminum (3) Stainless Steel (4) Conical Pressure Washer Plated or Stainless Steel | (1) Silicon Bronze (2) Stainless Steel | (1) Aluminum (2) Stainless Steel (3) Silicon Bronze Plated (4) Conical Pressure Washer Plated or Stainless Steel | (1) Aluminum (2) Stainless Steel (3) Conical Pressure Washer Plated or Stainless Steel |

(1) Denotes preferred hardware usage
Note: Contact sealant recommended between aluminum to aluminum and aluminum to copper connections, unless other protective measures are taken.

Bar Connections

The tang of a compression or a mechanical connector is a bus bar, which connects to another bus bar. If you remember the rule about wire brushing and using joint compound with bare (unplated) aluminum, you cannot go wrong. Plated parts should be cleaned with a solvent if they are dirty, but never abrade or otherwise disturb the plating! Fig. 3 shows a typical bar connection and the type of hardware used.

For optimum efficiency, it is necessary that the correct bolt, nut and washer combination be used with the correct combination of conductor materials. Table II shows acceptable methods of joining different combinations of bus bar. Where different combinations of metals are being joined, a follow-up device such as a conical pressure washer is usually recommended if one, or both, bus materials are soft drawn aluminum. If both bars are hard drawn, large flat washers will suffice regardless of the bolt materials.

Other considerations which should be taken into account when selecting hardware are corrosion and vibration. For example, if severe corrosion is anticipated, non-corrosive materials such as stainless steel or silicon bronze, should be selected in preference to galvanized steel. If vibration is anticipated, the use of locking washers should be considered.

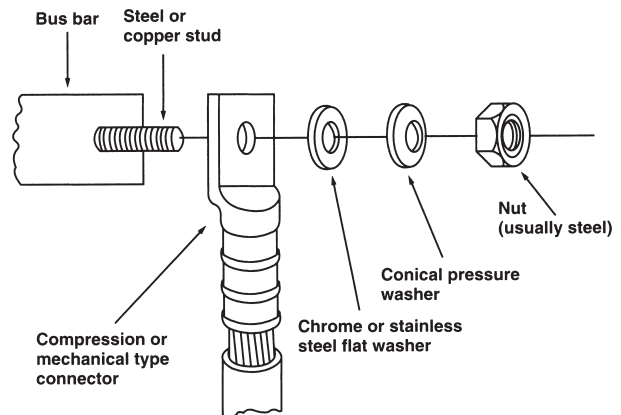

Figure 3. Contact surfaces must be clean. Use a joint compound with bare aluminum. Conical pressure washer is usually recommended if one, or both, bus materials are soft drawn aluminum.

Subject: Restriction of Hazardous Substances (RoHS)

European Directive 2011/65/EU

As of July 1st 2006 nVent ILSCO is capable of supplying all items offered for sale compliant with the standards listed in the RoHS directive.

All cataloged items are RoHS Compliant unless noted to the contrary.

nVent ILSCO makes no independent representations or a warranty, expressed or implied, and assumes no liability in connection with the use of this information.

Access to Cross Reference can be found under Reference Tab at www.nVent.com/ILSCO

Two Ways to Search

1. Type in all or part of the competitive or nVent ILSCO part number into the **SEARCH** box in the header, then click **GO**.
2. Click "Search Options" in the header. From there, you are given five ways to search.

By Keyword: Type in a keyword and click **GO**. For example, typing "splice" will return a list of products that can be used to splice conductor. You can click on any of the products listed and you will be taken to the catalog page.

By nVent ILSCO Catalog #: Type in all or part of the nVent ILSCO part number and click **GO**. You can click on any of the products listed and you will be taken to the catalog page.

By UPC/NAED Part #: Type in the nVent ILSCO UPC number and click **GO**. The nVent ILSCO corporate identifier, 783669, is already given. For example, typing "88774" will return information on "TA-2".

By Competitive Part #: Type in all or part of the competitive part number and click **GO**. You do not need to know the manufacturer. You are given a list of comparable nVent ILSCO products. You can click on any of the products listed and you will be taken to the catalog page.

Choose a category: Select a product category from the list and click **GO**. You will receive a list of the product groups in that category. You can click on any of the products listed and you will be taken to the catalog page.

If your request is not in our database, you will be sent to a screen where you can send an e-mail to nVent ILSCO's technical support department. Your request will be answered promptly.

This cross reference information has been compiled from tables, catalogs and data which are generally available. Since changes are made regularly in the industry, we cannot accept responsibility for any errors, but we will endeavor at all times to keep these tables up-to-date. Refer to our current catalog for exact specifications on nVent ILSCO connectors. All connectors are not exact equals, but enough similarities exist that they can be used for the same application.

Alpha Numeric Index

| CATALOG NO. | PAGE NO. | CATALOG NO. | PAGE NO. | CATALOG NO. | PAGE NO. |
|------------------------|----------|------------------|----------|-------------------|----------|
| ‡°PDB-55-500-1 | 264 | 21712-B | 340 | 30379-B10 | 88 |
| + ‡ GBL-4SS | 286 | 21748 | 340 | 30385-B10 | 88 |
| 1-1/8 | 45 | 22106-B3 | 342 | 30387-B10 | 88 |
| 1/2 | 45 | 22112-B3 | 342 | 30395-B10 | 88 |
| 1/4 | 45 | 22206-B3 | 342 | 30397-B10 | 88 |
| 1-5/16 | 45 | 22212-B3 | 342 | 30487-B10 | 88 |
| 2ACL, 2ACN 4/0-8 | 381 | 22306-B3 | 342 | 30497-B10 | 88 |
| 2IACL-1/0 | 68 | 22312-B3 | 342 | 31112-B10 | 86 |
| 2IACL-1/0 | 68 | 22406-B2 | 342 | 31113-B10 | 86 |
| 2IACL-2/0 | 68 | 22412-B2 | 342 | 31114-B10 | 86 |
| 2IACL-2/0 | 68 | 23081-B2 | 341 | 31115-B10 | 86 |
| 2IACL-3/0 | 68 | 23125-B2 | 341 | 31122-B10 | 87 |
| 2IACL-3/0 | 68 | 23210-B2 | 341 | 31122FL-B10 | 87 |
| 2IACL-4/0 | 68 | 24001-B10 | 343 | 31123-B10 | 87 |
| 2IACL-4/0 | 68 | 24002-B10 | 343 | 31123FL-B10 | 87 |
| 2IACL-250 | 68 | 24003-B10 | 343 | 31124-B10 | 87 |
| 2IACL-250 | 68 | 24004-B10 | 343 | 31124FL-B10 | 87 |
| 2IACL-300 | 68 | 24005-B10 | 343 | 31130-B10 | 88 |
| 2IACL-300 | 68 | 24006-B10 | 343 | 31312-B10 | 86 |
| 2IACL-350 | 68 | 24007-B5 | 343 | 31313-B10 | 86 |
| 2IACL-350 | 68 | 24008-B5 | 343 | 31314-B10 | 86 |
| 2IACL-500 | 68 | 24009-B5 | 343 | 31315-B10 | 86 |
| 2IACL-500 | 68 | 24010-B5 | 343 | 31316-B10 | 86 |
| 2IACL-600 | 68 | 24011-B5 | 343 | 31317-B10 | 86 |
| 2IACL-600 | 68 | 24999-B12+ | 343 | 31322-B10 | 87 |
| 2IACL-750 | 68 | 25001 | 343 | 31322FL-B10 | 87 |
| 2IACL-750 | 68 | 25002 | 343 | 31323-B10 | 87 |
| 2IACL-1000 | 68 | 25003 | 343 | 31323FL-B10 | 87 |
| 2IACL-1000 | 68 | 25004 | 343 | 31324-B10 | 87 |
| 2SC-50 | 197 | 25005 | 343 | 31324FL-B10 | 87 |
| 3/8 | 45 | 25006 | 343 | 31330-B10 | 88 |
| 3/16 | 45 | 25007 | 343 | 31369-B10 | 88 |
| 5/8 | 45 | 25008 | 343 | 31413-B10 | 86 |
| 5/16 | 45 | 25009 | 343 | 31414-B10 | 86 |
| 7/16 | 45 | 25010 | 343 | 31415-B10 | 86 |
| 9/16 | 45 | 25011 | 343 | 31417-B10 | 86 |
| 11/16 | 45 | 26001 | 344 | 31419-B10 | 86 |
| 13/16 | 45 | 26002 | 344 | 31422-B10 | 87 |
| 9200 | 339 | 26003 | 344 | 31422FL-B10 | 87 |
| 21106-B3* | 340 | 26004 | 344 | 31423-B10 | 87 |
| 21112-B3* | 340 | 26005 | 344 | 31423FL-B10 | 87 |
| 21206-B3 | 340 | 26006 | 344 | 31424-B10 | 87 |
| 21209-B3 | 340 | 26007 | 344 | 31424FL-B10 | 87 |
| 21212-B3 | 340 | 26008 | 344 | 31430-B10 | 88 |
| 21230 | 340 | 26009 | 344 | 31514-B5 | 86 |
| 21406-B2 | 340 | 26010 | 344 | 31515-B5 | 86 |
| 21409-B2 | 340 | 26011 | 344 | 31517-B5 | 86 |
| 21412-B2 | 340 | 27001 | 345 | 31519-B5 | 86 |
| 21448 | 340 | 27001 | 399 | 31530-B5 | 88 |
| 21609-B2 | 340 | 30185-B10 | 88 | 44130-B10 | 91 |
| 21612-B2 | 340 | 30187-B10 | 88 | 44131-B10 | 91 |
| 21648 | 340 | 30195-B10 | 88 | 44140-B10 | 91 |
| 21709-B | 340 | 30197-B10 | 88 | 44141-B10 | 91 |

Alpha Numeric Index

| CATALOG NO. | PAGE NO. | CATALOG NO. | PAGE NO. | CATALOG NO. | PAGE NO. |
|-------------|----------|----------------|----------|-----------------|----------|
| 44142-B10 | 91 | 44322-B20 | 97 | ACMN-400 | 66 |
| 44143-B10 | 91 | 44323-B20 | 97 | ACMN-500 | 66 |
| 44150-B10 | 92 | 44330-B10 | 97 | ACMN-500 | 66 |
| 44151-B10 | 92 | 44340-B10 | 97 | ACMN-600 | 66 |
| 44152-B10 | 92 | 44630-B10 | 122 | ACMN-600 | 66 |
| 44153-B10 | 92 | 44640-B10 | 122 | ACMN-750 | 66 |
| 44154-B10 | 92 | 44650-B10 | 122 | ACMN-750 | 66 |
| 44155-B10 | 92 | 44730-B5 | 123 | ACM Series | 363 |
| 44160-B10 | 92 | 44740-B5 | 123 | ACO-90 Series | 363 |
| 44161-B10 | 92 | 44750-B5 | 123 | ACON-2/0 | 64 |
| 44162-B10 | 92 | 44830-B10 | 122 | ACON-2/0 | 64 |
| 44163-B10 | 92 | 44840-B10 | 122 | ACON-3/0 | 64 |
| 44164-B10 | 92 | 44850-B10 | 122 | ACON-3/0 | 64 |
| 44165-B10 | 92 | 44930-B5 | 123 | ACON-4/0 | 64 |
| 44170-B2 | 92 | 44940-B5 | 123 | ACON-4/0 | 64 |
| 44171-B2 | 92 | 44950-B5 | 123 | ACON-250 | 65 |
| 44172-B2 | 92 | 94502 | 345 | ACON-250 | 65 |
| 44173-B2 | 92 | 94502 | 399 | ACON-300 | 65 |
| 44174-B2 | 92 | 94504 | 345 | ACON-300 | 65 |
| 44180-B2 | 93 | 94504 | 399 | ACON-350 | 65 |
| 44181-B2 | 93 | 99201 | 339 | ACON-350 | 65 |
| 44182-B2 | 93 | 99202 | 339 | ACON-500 | 66 |
| 44183-B2 | 93 | 99205 | 339 | ACON-500 | 66 |
| 44184-B2 | 93 | 99206 | 339 | ACON-600 | 66 |
| 44190-B2 | 93 | 99207 | 339 | ACON-600 | 66 |
| 44191-B2 | 93 | 99208 | 339 | ACON-750 | 66 |
| 44192-B2 | 93 | 99209 | 339 | ACON-750 | 66 |
| 44193-B2 | 93 | 99211 | 339 | ACO Series | 363 |
| 44194-B2 | 93 | 99212 | 339 | AH-1 | 72 |
| 44195-B2 | 93 | ACL, ACN 4/0-8 | 381 | AH-1-4 | 363 |
| 44196-B2 | 93 | ACMN-1 | 63 | AH-2 | 72 |
| 44197-B2 | 93 | ACMN-1 | 63 | AH-3 | 72 |
| 44198-B2 | 93 | ACMN-1/0 | 63 | AH-4 | 72 |
| 44230-B5 | 95 | ACMN-1/0 | 63 | AH-5 | 72 |
| 44231-B5 | 95 | ACMN-2 | 63 | AH-6 | 72 |
| 44240-B5 | 95 | ACMN-2 | 63 | AH-10 | 72 |
| 44241-B5 | 95 | ACMN-2/0 | 64 | AH-11 | 72 |
| 44242-B5 | 95 | ACMN-2/0 | 64 | AK-1/0 | 134 |
| 44243-B5 | 95 | ACMN-3/0 | 64 | AK-2 | 134 |
| 44250-B5 | 95 | ACMN-3/0 | 64 | AK-2/0 | 134 |
| 44251-B5 | 95 | ACMN-4 | 63 | AK-4 | 134 |
| 44252-B5 | 95 | ACMN-4 | 63 | AK-4/0 | 134 |
| 44253-B5 | 95 | ACMN-4/0 | 64 | AK-6 | 134 |
| 44254-B5 | 95 | ACMN-4/0 | 64 | AK-350 | 134 |
| 44255-B5 | 95 | ACMN-6 | 63 | AK-500 | 134 |
| 44300-B20 | 97 | ACMN-6 | 63 | ALND-1/0-12-1 | 51 |
| 44301-B20 | 97 | ACMN-250 | 65 | ALND-1/0-12-134 | 51 |
| 44302-B20 | 97 | ACMN-250 | 65 | ALND-1/0-14-1 | 51 |
| 44310-B20 | 97 | ACMN-300 | 65 | ALND-1/0-38-1 | 51 |
| 44311-B20 | 97 | ACMN-300 | 65 | ALND-1/0-38-134 | 51 |
| 44312-B20 | 97 | ACMN-350 | 65 | ALND-1-14-1 | 51 |
| 44320-B20 | 97 | ACMN-350 | 65 | ALND-1-38-1 | 51 |
| 44321-B20 | 97 | ACMN-400 | 66 | ALND-1-38-134 | 51 |

Alpha Numeric Index

| CATALOG NO. | PAGE NO. | CATALOG NO. | PAGE NO. | CATALOG NO. | PAGE NO. |
|---------------------|----------|-----------------|----------|---------------------|----------|
| ALND-2/0-12-1 | 51 | ALNN-1-14-1 | 55 | ALNN-600-38-134 | 56 |
| ALND-2/0-12-134 | 51 | ALNN-1-516 | 54 | ALNN-600-58 | 54 |
| ALND-2/0-38-1 | 51 | ALNN-2/0-38 | 54 | ALNN-700/750-12 | 54 |
| ALND-2/0-38-134 | 51 | ALNN-2/0-38-1 | 55 | ALNN-700/750-12-1 | 56 |
| ALND-2-14-1 | 51 | ALNN-2/0-38-134 | 55 | ALNN-700/750-12-134 | 56 |
| ALND-2-38-1 | 51 | ALNN-2-14 | 54 | ALNN-700/750-38-1 | 56 |
| ALND-2-38-134 | 51 | ALNN-2-14-1 | 55 | ALNN-700/750-38-134 | 56 |
| ALND-3/0-12-1 | 51 | ALNN-3/0-12 | 54 | ALNN-700/750-58 | 54 |
| ALND-3/0-12-134 | 51 | ALNN-3/0-12-134 | 55 | ALNN-1000-12 | 54 |
| ALND-3/0-38-1 | 51 | ALNN-3/0-38 | 54 | ALNN-1000-12-1 | 56 |
| ALND-3/0-38-134 | 51 | ALNN-3/0-38-1 | 55 | ALNN-1000-12-134 | 56 |
| ALND-4/0-12-1 | 51 | ALNN-3/0-38-134 | 55 | ALNN-1000-38-1 | 56 |
| ALND-4/0-12-134 | 51 | ALNN-4/0-12 | 54 | ALNN-1000-38-134 | 56 |
| ALND-4/0-38-1 | 51 | ALNN-4/0-12-1 | 55 | ALNN-1000-58 | 54 |
| ALND-4/0-38-134 | 51 | ALNN-4/0-12-134 | 55 | ALNN thru 4/0 | 381 |
| ALND-4-14-1 | 51 | ALNN-4/0-38 | 54 | ALNN thru 750kcmill | 363 |
| ALND-6-14-1 | 51 | ALNN-4/0-38-1 | 55 | ALNS-1/0-12 | 49 |
| ALND-8-10-1 | 51 | ALNN-4/0-38-134 | 55 | ALNS-1/0-38 | 49 |
| ALND-250-12-1 | 52 | ALNN-4-14 | 54 | ALNS-1/0-516 | 49 |
| ALND-250-12-134 | 52 | ALNN-4-14-1 | 55 | ALNS-1-14 | 49 |
| ALND-250-38-1 | 52 | ALNN-250-12 | 54 | ALNS-1-38 | 49 |
| ALND-250-38-134 | 52 | ALNN-250-12-1 | 55 | ALNS-1-516 | 49 |
| ALND-300-12-1 | 52 | ALNN-250-12-134 | 55 | ALNS-2/0-12 | 49 |
| ALND-300-12-134 | 52 | ALNN-250-38 | 54 | ALNS-2/0-38 | 49 |
| ALND-300-38-1 | 52 | ALNN-250-38-1 | 55 | ALNS-2-14 | 49 |
| ALND-300-38-134 | 52 | ALNN-250-38-134 | 55 | ALNS-2-38 | 49 |
| ALND-350-12-1 | 52 | ALNN-300-12 | 54 | ALNS-2-516 | 49 |
| ALND-350-12-134 | 52 | ALNN-300-12-1 | 55 | ALNS-3/0-12 | 49 |
| ALND-350-38-1 | 52 | ALNN-300-12-134 | 55 | ALNS-3/0-38 | 49 |
| ALND-350-38-134 | 52 | ALNN-300-38 | 54 | ALNS-4/0-12 | 49 |
| ALND-400-12-1 | 52 | ALNN-300-38-1 | 55 | ALNS-4/0-38 | 49 |
| ALND-400-12-134 | 52 | ALNN-300-38-134 | 55 | ALNS-4-14 | 49 |
| ALND-400-38-1 | 52 | ALNN-350-12 | 54 | ALNS-4-516 | 49 |
| ALND-400-38-134 | 52 | ALNN-350-12-1 | 56 | ALNS-6-14 | 49 |
| ALND-500-12-1 | 52 | ALNN-350-12-134 | 56 | ALNS-8-10 | 49 |
| ALND-500-12-134 | 52 | ALNN-350-38-1 | 56 | ALNS-250-12 | 50 |
| ALND-500-38-1 | 52 | ALNN-350-38-134 | 56 | ALNS-250-38 | 50 |
| ALND-500-38-134 | 52 | ALNN-400-12 | 54 | ALNS-300-12 | 50 |
| ALND-600-12-1 | 53 | ALNN-400-12-1 | 56 | ALNS-300-38 | 50 |
| ALND-600-12-134 | 53 | ALNN-400-12-134 | 56 | ALNS-350-12 | 50 |
| ALND-600-38-1 | 53 | ALNN-400-38-1 | 56 | ALNS-400-12 | 50 |
| ALND-600-38-134 | 53 | ALNN-400-38-134 | 56 | ALNS-400-58 | 50 |
| ALND-700/750-12-1 | 53 | ALNN-400-58 | 54 | ALNS-500-12 | 50 |
| ALND-700/750-12-134 | 53 | ALNN-500-12 | 54 | ALNS-500-58 | 50 |
| ALND-700/750-38-1 | 53 | ALNN-500-12-1 | 56 | ALNS-600-12 | 50 |
| ALND-700/750-38-134 | 53 | ALNN-500-12-134 | 56 | ALNS-600-58 | 50 |
| ALND-1000-12-1 | 53 | ALNN-500-38-1 | 56 | ALNS-700/750-12 | 50 |
| ALND-1000-12-134 | 53 | ALNN-500-38-134 | 56 | ALNS-1000-12 | 50 |
| ALND-1000-38-1 | 53 | ALNN-500-58 | 54 | ALNS-1000-58 | 50 |
| ALND-1000-38-134 | 53 | ALNN-600-12 | 54 | AS 4/0-8 | 381 |
| ALNN-1/0-14-1 | 55 | ALNN-600-12-1 | 56 | ASK-2* | 319 |
| ALNN-1/0-516 | 54 | ALNN-600-12-134 | 56 | ASK-250* | 319 |
| ALNN-1-14 | 54 | ALNN-600-38-1 | 56 | ASL-250 | 58 |

Alpha Numeric Index

| CATALOG NO. | PAGE NO. | CATALOG NO. | PAGE NO. | CATALOG NO. | PAGE NO. |
|--------------|----------|--------------------|----------|--------------------|----------|
| ASL-250 | 309 | BBFC-2-10-16-KIT | 302 | BBTC-2T-3000-00600 | 309 |
| ASL-750 | 58 | BBFC-2-24-36 | 304 | BBTC-2T-3000-01200 | 309 |
| ASL-750 | 309 | BBFC-2-24-36-KIT | 302 | BBTC-2T-3000-01800 | 309 |
| ASN-1 | 57 | BBFC-4-10-22A | 303 | BBTC-2T-3000-02400 | 309 |
| ASN-1/0 | 57 | BBFC-4-10-22A-KIT | 302 | BBTC-2T-3000-03000 | 309 |
| ASN-2 | 57 | BBFC-4-10-22B | 303 | BBTC-2T-3000-03600 | 309 |
| ASN-2/0 | 57 | BBFC-4-10-22B-KIT | 302 | BBTC-2T-3000-04800 | 309 |
| ASN-3/0 | 57 | BBFC-4-12 | 303 | BBTC-2T-3000-07200 | 309 |
| ASN-4 | 57 | BBFC-4-12-18 | 304 | BBTC-2T-3000-09600 | 309 |
| ASN-4/0 | 57 | BBFC-4-12-18-KIT | 302 | BBTC-2T-3000-12000 | 309 |
| ASN-6 | 57 | BBFC-4-12-24 | 304 | BBTC-2T-3000-14400 | 309 |
| ASN-8 | 57 | BBFC-4-12-24-KIT | 302 | BFBR-10-8-P50 | 112 |
| ASN-250 | 57 | BBFC-4-12-KIT | 302 | BFBR-10-10-P50 | 112 |
| ASN-300 | 57 | BBFC-4-16-24 | 304 | BFBR-10-14-P50 | 112 |
| ASN-350 | 57 | BBFC-4-16-24-KIT | 302 | BFBR-14-6-P50 | 112 |
| ASN-400 | 57 | BBFC-4-16-32 | 304 | BFBR-14-8-P50 | 112 |
| ASN-500 | 57 | BBFC-4-16-32-KIT | 302 | BFBR-14-10-P50 | 112 |
| ASN-600 | 57 | BBFC-4-20 | 303 | BFBR-14-14-P50 | 112 |
| ASN-700/750 | 57 | BBFC-4-20-18 | 303 | BFBR-18-6-P50 | 112 |
| ASN-1000 | 57 | BBFC-4-20-18-KIT | 302 | BFBR-18-8-P50 | 112 |
| ATAU-2/0-14 | 148 | BBFC-4-20-68 | 304 | BFBR-18-10-P50 | 112 |
| ATAU-350-12* | 148 | BBFC-4-20-68-KIT | 302 | BFBR-18-14-P50 | 112 |
| ATAU-350-14 | 148 | BBFC-4-20-KIT | 302 | BLDF-25HD | 352 |
| ATAU-600-12* | 148 | BBFC-4-24 | 303 | BLDF-25HD | 359 |
| ATTA-1/0-14 | 146 | BBFC-4-24-36 | 304 | BLDF-25HD | 364 |
| ATTA-2/0-14 | 146 | BBFC-4-24-36-KIT | 302 | BLDF-25HD | 368 |
| ATTA-250-14 | 146 | BBFC-4-24-KIT | 302 | BLDF-45 | 353 |
| ATTA-300-14 | 146 | BBFC-34-19-12-316 | 305 | BLDF-45 | 364 |
| ATTA-350-14 | 146 | BBFC-58-36-16 | 305 | BLDF-45 | 368 |
| ATTA-350-38 | 146 | BBTA-1T-1600-00600 | 306 | BLDF-50 | 354 |
| AU-0‡ | 147 | BBTA-1T-1600-01200 | 306 | BLDF-50 | 365 |
| AU-2/0‡ | 147 | BBTA-1T-1600-01800 | 306 | BLDF-50 | 369 |
| AU3/0I-TC | 144 | BBTA-1T-1600-02400 | 306 | BLDF-85 | 355 |
| AU-250‡ | 147 | BBTA-1T-1600-03000 | 306 | BLDF-85 | 365 |
| AU250I-TC | 144 | BBTA-1T-1600-03600 | 306 | BLDF-85 | 369 |
| AU-350‡ | 147 | BBTA-2T-3000-00600 | 307 | BLDF-120 | 358 |
| AU-350-2N‡ | 147 | BBTA-2T-3000-01200 | 307 | BLDG-65 | 356 |
| AU350I-TC | 144 | BBTA-2T-3000-01800 | 307 | BLDG-65 | 370 |
| AU-350-N* | 147 | BBTA-2T-3000-02400 | 307 | BLDG-95 | 357 |
| AU500I-TC | 144 | BBTA-2T-3000-03000 | 307 | BLDG-95 | 370 |
| AU-600 | 147 | BBTA-2T-3000-03600 | 307 | BLDI-26 | 361 |
| AU-600-2N* | 147 | BBTC-1T-1600-00600 | 308 | BLDK | 388 |
| AU-600-2NS | 147 | BBTC-1T-1600-01200 | 308 | BLDM-25 | 352 |
| AU-800 | 147 | BBTC-1T-1600-01800 | 308 | BLDM-25 | 359 |
| AU-800-2N* | 147 | BBTC-1T-1600-02400 | 308 | BLDM-25 | 364 |
| AU-800-2NS | 147 | BBTC-1T-1600-03000 | 308 | BLDM-25 | 368 |
| AU800I-TC | 144 | BBTC-1T-1600-03600 | 308 | BLDM-45 | 353 |
| AU-1000 | 147 | BBTC-1T-1600-04800 | 308 | BLDM-45 | 364 |
| AU-1000-2N* | 147 | BBTC-1T-1600-07200 | 308 | BLDM-45 | 368 |
| AU-1000-2NS | 147 | BBTC-1T-1600-09600 | 308 | BLDM-50 | 354 |
| BBFC-1-36-16 | 305 | BBTC-1T-1600-12000 | 308 | BLDM-50 | 365 |
| BBFC-2-10-16 | 304 | BBTC-1T-1600-14400 | 308 | BLDM-50 | 369 |

Alpha Numeric Index

| CATALOG NO. | PAGE NO. | CATALOG NO. | PAGE NO. | CATALOG NO. | PAGE NO. |
|----------------------|----------|----------------------|----------|------------------|----------|
| BLDM-85..... | 355 | BSBR-14-6-P50..... | 100 | CCL-1..... | 40 |
| BLDM-85..... | 365 | BSBR-14-8-P50..... | 100 | CCL-1/0..... | 41 |
| BLDM-85..... | 369 | BSBR-14-10-P50..... | 100 | CCL-1/0-12..... | 41 |
| BLDM-120..... | 358 | BSBR-14-14-P50..... | 100 | CCL-1/0-14..... | 41 |
| BLDM-120..... | 370 | BSBR-18-4-P50..... | 100 | CCL-1/0-38..... | 41 |
| BLDS-26..... | 361 | BSBR-18-6-P50..... | 100 | CCL-1/0-516..... | 41 |
| BLDS-40..... | 360 | BSBR-18-8-P50..... | 100 | CCL-1-12..... | 40 |
| BLDS-65..... | 356 | BSBR-18-10-P50..... | 100 | CCL-1-14..... | 40 |
| BLDS-65..... | 370 | BSFBR-10-6-P50..... | 108 | CCL-1-38..... | 40 |
| BLDS-95..... | 357 | BSFBR-10-8-P50..... | 108 | CCL-1-516..... | 40 |
| BLDS-95..... | 370 | BSFBR-10-10-P50..... | 108 | CCL-2..... | 40 |
| BLDS-120..... | 370 | BSFBR-14-6-P50..... | 108 | CCL-2/0..... | 41 |
| BLDST-CBS52..... | 393 | BSFBR-14-8-P50..... | 108 | CCL-2/0-12..... | 41 |
| BLDST-CC60..... | 395 | BSFBR-14-10-P50..... | 108 | CCL-2/0-14..... | 41 |
| BLDST-CJ54..... | 391 | BSFBR-18-6-P50..... | 108 | CCL-2/0-38..... | 41 |
| BLDST-CNS41..... | 394 | BSFBR-18-8-P50..... | 108 | CCL-2/0-516..... | 41 |
| BLDST-CP52..... | 392 | BSFBR-18-10-P50..... | 108 | CCL-2-12..... | 40 |
| BLDST-UJ25..... | 389 | BSLBR-10-6-P50..... | 104 | CCL-2-14..... | 40 |
| BLDST-UJ45..... | 390 | BSLBR-10-8-P50..... | 104 | CCL-2-38..... | 40 |
| BP6..... | 325 | BSLBR-10-10-P50..... | 104 | CCL-2-516..... | 40 |
| BP6..... | 326 | BSLBR-10-14-P50..... | 104 | CCL-3/0..... | 42 |
| BP8..... | 325 | BSLBR-14-6-P50..... | 104 | CCL-3/0-12..... | 42 |
| BP8..... | 326 | BSLBR-14-8-P50..... | 104 | CCL-3/0-14..... | 42 |
| BP10..... | 325 | BSLBR-14-10-P50..... | 104 | CCL-3/0-38..... | 42 |
| BP10..... | 326 | BSLBR-18-6-P50..... | 104 | CCL-3/0-516..... | 42 |
| BRBR-10-6MS-P50..... | 99 | BSLBR-18-8-P50..... | 104 | CCL-4..... | 39 |
| BRBR-10-6-P50..... | 90 | BSLBR-18-10-P50..... | 104 | CCL-4/0..... | 42 |
| BRBR-10-8-P50..... | 90 | C-10..... | 409 | CCL-4/0-12..... | 42 |
| BRBR-10-10-P50..... | 90 | C-11..... | 409 | CCL-4/0-14..... | 42 |
| BRBR-10-12-P25..... | 90 | C-13..... | 409 | CCL-4/0-38..... | 42 |
| BRBR-10-14-P50..... | 90 | C-15..... | 409 | CCL-4/0-516..... | 42 |
| BRBR-10-38-P25..... | 90 | C-16..... | 409 | CCL-4-10..... | 39 |
| BRBR-10-516-P50..... | 90 | C-24..... | 409 | CCL-4-12..... | 39 |
| BRBR-14-6MS-P50..... | 99 | C-28..... | 409 | CCL-4-14..... | 39 |
| BRBR-14-6-P50..... | 90 | CA4RP..... | 157 | CCL-4-38..... | 39 |
| BRBR-14-8-P50..... | 90 | CA4SP..... | 157 | CCL-4-516..... | 39 |
| BRBR-14-10-P50..... | 90 | CA5RP..... | 157 | CCL-6..... | 38 |
| BRBR-14-12-P50..... | 90 | CA5SP..... | 157 | CCL-6-10..... | 38 |
| BRBR-14-14-P50..... | 90 | CA6RP..... | 157 | CCL-6-12..... | 38 |
| BRBR-14-38-P25..... | 90 | CA7..... | 157 | CCL-6-14..... | 38 |
| BRBR-14-516-P50..... | 90 | CA8..... | 157 | CCL-6-38..... | 38 |
| BRBR-18-6MS-P50..... | 99 | CAN-300..... | 206 | CCL-6-516..... | 38 |
| BRBR-18-6-P50..... | 90 | CAN-300..... | 284 | CCL-8..... | 37 |
| BRBR-18-8-P50..... | 90 | CAN-300..... | 412 | CCL-8-10..... | 37 |
| BRBR-18-10-P50..... | 90 | CAN-301..... | 206 | CCL-8-12..... | 37 |
| BRBR-18-14-P50..... | 90 | CAN-301..... | 284 | CCL-8-14..... | 37 |
| BRBR-18-38-P25..... | 90 | CAN-301..... | 412 | CCL-8-38..... | 37 |
| BRBR-18-516-P50..... | 90 | CAN-302..... | 206 | CCL-8-516..... | 37 |
| BSBR-10-6-P50..... | 100 | CAN-302..... | 284 | CCS-1..... | 48 |
| BSBR-10-8-P50..... | 100 | CAN-302..... | 412 | CCS-1/0..... | 48 |
| BSBR-10-10-P50..... | 100 | CAN-303..... | 206 | CCS-2..... | 48 |
| BSBR-10-14-P50..... | 100 | CAN-303..... | 284 | CCS-2/0..... | 48 |
| BSBR-10-516-P50..... | 100 | CAN-303..... | 412 | CCS-3/0..... | 48 |

Alpha Numeric Index

| CATALOG NO. | PAGE NO. | CATALOG NO. | PAGE NO. | CATALOG NO. | PAGE NO. |
|-----------------|----------|------------------|----------|------------------|----------|
| CCS-4 | 48 | CLND-2/0-14-34 | 25 | CLND-6-12-134 | 23 |
| CCS-4/0 | 48 | CLND-2/0-14-58 | 25 | CLND-6-14-1 | 23 |
| CCS-6 | 48 | CLND-2/0-38-1 | 25 | CLND-6-14-12 | 23 |
| CGP2-250500 | 271 | CLND-2/0-38-134 | 25 | CLND-6-14-34 | 23 |
| CH-12V | 374 | CLND-2/0-516-1 | 25 | CLND-6-14-58 | 23 |
| CL-1-1 | 199 | CLND-2-10-34 | 24 | CLND-6-38-1 | 23 |
| CL-1-2/0 | 199 | CLND-2-12-134 | 24 | CLND-6-38-34 | 23 |
| CL-1-2/0N | 200 | CLND-2-14-1 | 24 | CLND-6-38-78 | 23 |
| CL-1-4/0 | 199 | CLND-2-14-34 | 24 | CLND-6-516-1 | 23 |
| CL-1-4/0N | 200 | CLND-2-14-58 | 24 | CLND-6-516-34 | 23 |
| CL-1-8† | 199 | CLND-2-38-1 | 24 | CLND-8-10-34 | 23 |
| CL-1-300 | 199 | CLND-2-38-34 | 24 | CLND-8-10-58 | 23 |
| CL-1-300N | 200 | CLND-2-38-78 | 24 | CLND-8-14-1 | 23 |
| CL-1-500 | 199 | CLND-2-38-134 | 24 | CLND-8-14-34 | 23 |
| CL-1-500N | 200 | CLND-2-516-1 | 24 | CLND-8-14-58 | 23 |
| CL-1-750 | 199 | CLND-2-516-34 | 24 | CLND-8-38-1 | 23 |
| CL-1-750N | 200 | CLND-3/0-12-134 | 25 | CLND-250-12-114 | 26 |
| CL-1-1000 | 199 | CLND-3/0-14-34 | 25 | CLND-250-12-134 | 26 |
| CL-1-1000N | 200 | CLND-3/0-14-58 | 25 | CLND-250-14-34 | 26 |
| CL-2-1 | 202 | CLND-3/0-38-1 | 25 | CLND-250-38-1 | 26 |
| CL-2-2/0 | 202 | CLND-3/0-516-1 | 25 | CLND-250-38-134 | 26 |
| CL-2-4† | 202 | CLND-3-12-134 | 24 | CLND-300-12-134 | 26 |
| CL-2-4/0 | 202 | CLND-3-14-34 | 24 | CLND-300-38-1 | 26 |
| CL-2-8† | 202 | CLND-3-14-58 | 24 | CLND-350-12-114 | 26 |
| CL-2-300 | 202 | CLND-3-38-1 | 24 | CLND-350-12-134 | 26 |
| CL-2-500 | 202 | CLND-3-38-34 | 24 | CLND-350-14-34 | 26 |
| CL-2-700 | 202 | CLND-3-516-1 | 24 | CLND-350-38-1 | 26 |
| CL-2-1000 | 202 | CLND-3-516-58 | 24 | CLND-350-516-134 | 26 |
| CL-3-4/0 | 202 | CLND-4/0-12-1 | 26 | CLND-400-12-134 | 27 |
| CL-3-300 | 202 | CLND-4/0-12-114 | 26 | CLND-400-38-1 | 27 |
| CL-3-500 | 202 | CLND-4/0-12-134 | 26 | CLND-400-38-116 | 27 |
| CL-3-750 | 202 | CLND-4/0-14-1 | 26 | CLND-500-12-114 | 27 |
| CL-3-1000 | 202 | CLND-4/0-14-34 | 26 | CLND-500-12-134 | 27 |
| CLND-1/0-12-1 | 25 | CLND-4/0-14-58 | 26 | CLND-500-14-34 | 27 |
| CLND-1/0-12-134 | 25 | CLND-4/0-38-1 | 26 | CLND-500-38-1 | 27 |
| CLND-1/0-14-1 | 25 | CLND-4/0-38-134 | 26 | CLND-600-12-134 | 27 |
| CLND-1/0-14-34 | 25 | CLND-4/0-516-1 | 26 | CLND-600-38-1 | 27 |
| CLND-1/0-14-58 | 25 | CLND-4/0-516-34 | 26 | CLND-650-12-114 | 27 |
| CLND-1/0-38-1 | 25 | CLND-4/0-516-134 | 26 | CLND-650-12-134 | 27 |
| CLND-1/0-38-134 | 25 | CLND-4-10-1 | 23 | CLND-650-38-1 | 27 |
| CLND-1/0-516-1 | 25 | CLND-4-10-34 | 23 | CLND-650-38-118 | 27 |
| CLND-1/0-516-34 | 25 | CLND-4-10-58 | 23 | CLND-650-516-1 | 27 |
| CLND-1/0-516-78 | 25 | CLND-4-12-134 | 23 | CLND-700-12-112 | 28 |
| CLND-1-12-134 | 24 | CLND-4-14-34 | 23 | CLND-700-12-134 | 28 |
| CLND-1-14-1 | 24 | CLND-4-14-58 | 23 | CLND-700-12-178 | 28 |
| CLND-1-14-34 | 24 | CLND-4-38-1 | 23 | CLND-700-38-1 | 28 |
| CLND-1-14-58 | 24 | CLND-4-38-34 | 23 | CLND-700-38-118 | 28 |
| CLND-1-38-1 | 24 | CLND-4-516-1 | 23 | CLND-750-12-112 | 28 |
| CLND-1-516-1 | 24 | CLND-4-516-34 | 23 | CLND-750-12-134 | 28 |
| CLND-1-516-78 | 24 | CLND-6-10-12 | 23 | CLND-750-38-1 | 28 |
| CLND-2/0-12-1 | 25 | CLND-6-10-34 | 23 | CLND-750-38-118 | 28 |
| CLND-2/0-12-134 | 25 | CLND-6-10-58 | 23 | CLND-750-58-112 | 28 |
| CLND-2/0-14-1 | 25 | CLND-6-10-1116 | 23 | | |

Alpha Numeric Index

| CATALOG NO. | PAGE NO. | CATALOG NO. | PAGE NO. | CATALOG NO. | PAGE NO. |
|------------------------|----------|--------------------|----------|-----------------------|----------|
| CLND-1000-12-114 | 28 | CLNS-3/0-38 | 15 | CLNU-1 | 31 |
| CLND-1000-12-134 | 28 | CLNS-3/0-516..... | 15 | CLNU-1/0 | 31 |
| CLND-1000-38-1 | 28 | CLNS-3-10..... | 14 | CLNU-2 | 31 |
| CLND-1000-58-112 | 28 | CLNS-3-12 | 14 | CLNU-2/0 | 31 |
| CLNF-2/0-12-134 | 29 | CLNS-3-14..... | 14 | CLNU-3 | 31 |
| CLNF-2/0-38..... | 29 | CLNS-3-38 | 14 | CLNU-3/0 | 31 |
| CLNF-3/0-12..... | 29 | CLNS-3-516..... | 14 | CLNU-4 | 31 |
| CLNF-3/0-12-134 | 29 | CLNS-4/0-12 | 15 | CLNU-4/0 | 31 |
| CLNF-4/0-12..... | 29 | CLNS-4/0-14 | 15 | CLNU-6 | 31 |
| CLNF-4/0-12-134 | 29 | CLNS-4/0-38 | 15 | CLNU-250..... | 31 |
| CLNF-250-12 | 29 | CLNS-4/0-516..... | 15 | CLNU-300..... | 31 |
| CLNF-250-12-134..... | 29 | CLNS-4-10..... | 14 | CLNU-350..... | 31 |
| CLNF-300-12-134..... | 29 | CLNS-4-12 | 14 | CLNU-400..... | 31 |
| CLNF-300-58 | 29 | CLNS-4-14..... | 14 | CLNU-500..... | 31 |
| CLNF-350-12-134..... | 29 | CLNS-4-38 | 14 | CLNU-600..... | 31 |
| CLNF-350-58 | 29 | CLNS-4-516..... | 14 | CLNU-650..... | 31 |
| CLNF-400-12-134..... | 29 | CLNS-6-10..... | 14 | CLNU-700..... | 31 |
| CLNF-400-58 | 29 | CLNS-6-12 | 14 | CLNU-750..... | 31 |
| CLNF-500-12-134..... | 29 | CLNS-6-14..... | 14 | CLNU-1000..... | 31 |
| CLNF-500-58 | 29 | CLNS-6-38 | 14 | CLWD-1/0-12-1 | 19 |
| CLNF-600-12-134..... | 30 | CLNS-6-516 | 14 | CLWD-1/0-12-134 | 19 |
| CLNF-600-58 | 30 | CLNS-8-10..... | 14 | CLWD-1/0-14-1 | 19 |
| CLNF-700-12-134..... | 30 | CLNS-8-14 | 14 | CLWD-1/0-14-34 | 19 |
| CLNF-700-58 | 30 | CLNS-8-38 | 14 | CLWD-1/0-14-58 | 19 |
| CLNF-750-12-134..... | 30 | CLNS-8-516 | 14 | CLWD-1/0-38-1 | 19 |
| CLNF-750-58 | 30 | CLNS-250-12..... | 15 | CLWD-1/0-38-134 | 19 |
| CLNF-1000-12-134..... | 30 | CLNS-250-38..... | 15 | CLWD-1/0-516-1 | 19 |
| CLNF-1000-58 | 30 | CLNS-250-516 | 15 | CLWD-1/0-516-34 | 19 |
| CLNF-1111-12-134..... | 30 | CLNS-300-12..... | 15 | CLWD-1/0-516-78 | 19 |
| CLNF-1111-58 | 30 | CLNS-300-38..... | 15 | CLWD-1-12-134..... | 18 |
| CLNS-1/0-10 | 14 | CLNS-300-516 | 15 | CLWD-1-14-1 | 18 |
| CLNS-1/0-12 | 14 | CLNS-350-12 | 15 | CLWD-1-14-34..... | 18 |
| CLNS-1/0-14 | 14 | CLNS-350-38 | 15 | CLWD-1-14-58..... | 18 |
| CLNS-1/0-38 | 14 | CLNS-350-58 | 15 | CLWD-1-38-1 | 18 |
| CLNS-1/0-516..... | 14 | CLNS-400-12..... | 15 | CLWD-1-516-1..... | 18 |
| CLNS-1-10..... | 14 | CLNS-400-38..... | 15 | CLWD-1-516-78..... | 18 |
| CLNS-1-12 | 14 | CLNS-400-58..... | 15 | CLWD-2/0-12-1 | 19 |
| CLNS-1-14..... | 14 | CLNS-500-12 | 16 | CLWD-2/0-12-134 | 19 |
| CLNS-1-38..... | 14 | CLNS-500-38..... | 16 | CLWD-2/0-14-1 | 19 |
| CLNS-1-516..... | 14 | CLNS-500-58..... | 16 | CLWD-2/0-14-34 | 19 |
| CLNS-2/0-10 | 15 | CLNS-600-12 | 16 | CLWD-2/0-14-58 | 19 |
| CLNS-2/0-12 | 15 | CLNS-600-38 | 16 | CLWD-2/0-38-1 | 19 |
| CLNS-2/0-14 | 15 | CLNS-600-58 | 16 | CLWD-2/0-38-134 | 19 |
| CLNS-2/0-38 | 15 | CLNS-650-12 | 16 | CLWD-2/0-516-1 | 19 |
| CLNS-2/0-516..... | 15 | CLNS-650-38 | 16 | CLWD-2-10-34..... | 18 |
| CLNS-2-10..... | 14 | CLNS-650-58 | 16 | CLWD-2-12-134..... | 18 |
| CLNS-2-12 | 14 | CLNS-650-516 | 16 | CLWD-2-14-1 | 18 |
| CLNS-2-14..... | 14 | CLNS-700-12..... | 16 | CLWD-2-14-34..... | 18 |
| CLNS-2-38..... | 14 | CLNS-700-38..... | 16 | CLWD-2-14-58..... | 18 |
| CLNS-2-516..... | 14 | CLNS-700-58..... | 16 | CLWD-2-38-1 | 18 |
| CLNS-3/0-10 | 15 | CLNS-1000-12 | 16 | CLWD-2-38-34..... | 18 |
| CLNS-3/0-12 | 15 | CLNS-1000-38 | 16 | CLWD-2-38-58..... | 18 |
| CLNS-3/0-14 | 15 | CLNS-1000-58 | 16 | CLWD-2-38-78..... | 18 |

Alpha Numeric Index

| CATALOG NO. | PAGE NO. | CATALOG NO. | PAGE NO. | CATALOG NO. | PAGE NO. |
|-----------------------|----------|-------------------------|----------|--------------------------|----------|
| CLWD-2-38-134..... | 18 | CLWD-8-10-34..... | 17 | CLWDS-3/0-12-1-134..... | 34 |
| CLWD-2-516-1..... | 18 | CLWD-8-10-58..... | 17 | CLWDS-3/0-38-1-134..... | 34 |
| CLWD-2-516-34..... | 18 | CLWD-8-14-1..... | 17 | CLWDS-3-14-58-1..... | 34 |
| CLWD-2-516-58..... | 18 | CLWD-8-14-34..... | 17 | CLWDS-3-38-58-1..... | 34 |
| CLWD-3/0-12-134..... | 19 | CLWD-8-14-58..... | 17 | CLWDS-4/0-12-1-134..... | 34 |
| CLWD-3/0-14-34..... | 19 | CLWD-8-38-1..... | 17 | CLWDS-4/0-38-1-134..... | 34 |
| CLWD-3/0-14-58..... | 19 | CLWD-250-12-114..... | 20 | CLWDS-4-14-58-1..... | 34 |
| CLWD-3/0-38-1..... | 19 | CLWD-250-12-134..... | 20 | CLWDS-4-38-58-1..... | 34 |
| CLWD-3/0-516-1..... | 19 | CLWD-250-14-34..... | 20 | CLWDS-6-14-58-1..... | 34 |
| CLWD-3-12-134..... | 18 | CLWD-250-38-1..... | 20 | CLWDS-250-12-1-134..... | 34 |
| CLWD-3-14-34..... | 18 | CLWD-250-38-134..... | 20 | CLWDS-250-38-1-134..... | 34 |
| CLWD-3-14-58..... | 18 | CLWD-300-12-134..... | 20 | CLWDS-300-12-1-134..... | 34 |
| CLWD-3-38-1..... | 18 | CLWD-300-38-1..... | 20 | CLWDS-300-38-1-134..... | 34 |
| CLWD-3-38-34..... | 18 | CLWD-350-12-114..... | 21 | CLWDS-350-12-1-134..... | 35 |
| CLWD-3-516-1..... | 18 | CLWD-350-12-134..... | 21 | CLWDS-350-38-1-134..... | 35 |
| CLWD-3-516-58..... | 18 | CLWD-350-14-34..... | 21 | CLWDS-400-12-1-134..... | 35 |
| CLWD-4/0-12-1..... | 20 | CLWD-350-38-1..... | 21 | CLWDS-400-38-1-134..... | 35 |
| CLWD-4/0-12-114..... | 20 | CLWD-350-516-134..... | 21 | CLWDS-500-12-1-134..... | 35 |
| CLWD-4/0-12-134..... | 20 | CLWD-400-12-134..... | 21 | CLWDS-600-12-1-134..... | 35 |
| CLWD-4/0-14-1..... | 20 | CLWD-400-38-1..... | 21 | CLWDS-650-12-1-134..... | 35 |
| CLWD-4/0-14-34..... | 20 | CLWD-400-38-116..... | 21 | CLWDS-700-12-1-134..... | 35 |
| CLWD-4/0-14-58..... | 20 | CLWD-500-12-114..... | 21 | CLWDS-750-12-1-134..... | 35 |
| CLWD-4/0-38-1..... | 20 | CLWD-500-12-134..... | 21 | CLWDS-1000-12-1-134..... | 35 |
| CLWD-4/0-38-134..... | 20 | CLWD-500-14-34..... | 21 | CLWN-250-38-1..... | 33 |
| CLWD-4/0-516-1..... | 20 | CLWD-600-12-134..... | 21 | CLWN-500-38-1..... | 33 |
| CLWD-4/0-516-34..... | 20 | CLWD-600-38-1..... | 21 | CLWN-700-12-134..... | 33 |
| CLWD-4/0-516-134..... | 20 | CLWD-650-12-114..... | 21 | CLWN-700-38-1..... | 33 |
| CLWD-4-10-1..... | 17 | CLWD-650-12-134..... | 21 | CLWN-750-12-134..... | 33 |
| CLWD-4-10-34..... | 17 | CLWD-650-38-1..... | 21 | CLWN-750-38-1..... | 33 |
| CLWD-4-10-58..... | 17 | CLWD-650-38-118..... | 21 | CLWN-1000-38-1..... | 33 |
| CLWD-4-12-134..... | 17 | CLWD-650-516-1..... | 21 | CLWS-1/0-10..... | 11 |
| CLWD-4-14-1..... | 17 | CLWD-700-12-112..... | 22 | CLWS-1/0-12..... | 11 |
| CLWD-4-14-34..... | 17 | CLWD-700-12-134..... | 22 | CLWS-1/0-14..... | 11 |
| CLWD-4-14-58..... | 17 | CLWD-700-12-178..... | 22 | CLWS-1/0-38..... | 11 |
| CLWD-4-38-1..... | 17 | CLWD-700-38-1..... | 22 | CLWS-1/0-516..... | 11 |
| CLWD-4-38-34..... | 17 | CLWD-700-38-118..... | 22 | CLWS-1-10..... | 11 |
| CLWD-4-516-1..... | 17 | CLWD-750-12-112..... | 22 | CLWS-1-12..... | 11 |
| CLWD-4-516-34..... | 17 | CLWD-750-12-134..... | 22 | CLWS-1-14..... | 11 |
| CLWD-4-516-58..... | 17 | CLWD-750-38-1..... | 22 | CLWS-1-38..... | 11 |
| CLWD-6-10-12..... | 17 | CLWD-750-38-118..... | 22 | CLWS-1-516..... | 11 |
| CLWD-6-10-34..... | 17 | CLWD-750-58-112..... | 22 | CLWS-2/0-10..... | 12 |
| CLWD-6-10-58..... | 17 | CLWD-1000-12-114..... | 22 | CLWS-2/0-12..... | 12 |
| CLWD-6-10-1116..... | 17 | CLWD-1000-12-134..... | 22 | CLWS-2/0-14..... | 12 |
| CLWD-6-12-134..... | 17 | CLWD-1000-38-1..... | 22 | CLWS-2/0-38..... | 12 |
| CLWD-6-14-1..... | 17 | CLWD-1000-58-112..... | 22 | CLWS-2/0-516..... | 12 |
| CLWD-6-14-12..... | 17 | CLWDS-1/0-12-1-134..... | 34 | CLWS-2-10..... | 11 |
| CLWD-6-14-34..... | 17 | CLWDS-1/0-38-1-134..... | 34 | CLWS-2-12..... | 11 |
| CLWD-6-14-58..... | 17 | CLWDS-1-14-58-1..... | 34 | CLWS-2-14..... | 11 |
| CLWD-6-38-1..... | 17 | CLWDS-1-38-58-1..... | 34 | CLWS-2-38..... | 11 |
| CLWD-6-38-34..... | 17 | CLWDS-2/0-12-1-134..... | 34 | CLWS-2-516..... | 11 |
| CLWD-6-38-78..... | 17 | CLWDS-2/0-38-1-134..... | 34 | CLWS-3/0-10..... | 12 |
| CLWD-6-516-1..... | 17 | CLWDS-2-14-58-1..... | 34 | CLWS-3/0-12..... | 12 |
| CLWD-6-516-34..... | 17 | CLWDS-2-38-58-1..... | 34 | CLWS-3/0-14..... | 12 |

Alpha Numeric Index

| CATALOG NO. | PAGE NO. | CATALOG NO. | PAGE NO. | CATALOG NO. | PAGE NO. |
|--------------|----------|--------------|----------|--------------|----------|
| CLWS-3/0-38 | 12 | CLWS-750-38 | 13 | CPM-250 | 61 |
| CLWS-3/0-516 | 12 | CLWS-750-58 | 13 | CPM-300 | 61 |
| CLWS-3-10 | 11 | CLWS-1000-12 | 13 | CPM-300 | 61 |
| CLWS-3-12 | 11 | CLWS-1000-38 | 13 | CPM-350 | 61 |
| CLWS-3-14 | 11 | CLWS-1000-58 | 13 | CPM-350 | 61 |
| CLWS-3-38 | 11 | CLWU-1 | 36 | CPM-400 | 61 |
| CLWS-3-516 | 11 | CLWU-1/0 | 36 | CPM-400 | 61 |
| CLWS-4/0-12 | 12 | CLWU-2 | 36 | CPM-500 | 61 |
| CLWS-4/0-14 | 12 | CLWU-2/0 | 36 | CPM-500 | 61 |
| CLWS-4/0-38 | 12 | CLWU-3 | 36 | CPM-600 | 61 |
| CLWS-4/0-516 | 12 | CLWU-3/0 | 36 | CPM-600 | 61 |
| CLWS-4-10 | 11 | CLWU-4 | 36 | CPM-750 | 62 |
| CLWS-4-12 | 11 | CLWU-4/0 | 36 | CPM-750 | 62 |
| CLWS-4-14 | 11 | CLWU-6 | 36 | CPM-I/0 | 60 |
| CLWS-4-38 | 11 | CLWU-250 | 36 | CPML-500 | 62 |
| CLWS-4-516 | 11 | CLWU-300 | 36 | CPML-500 | 62 |
| CLWS-6-10 | 11 | CLWU-350 | 36 | CPML-600 | 62 |
| CLWS-6-12 | 11 | CLWU-400 | 36 | CPML-600 | 62 |
| CLWS-6-14 | 11 | CLWU-500 | 36 | CPML-750 | 62 |
| CLWS-6-38 | 11 | CLWU-600 | 36 | CPML-750 | 62 |
| CLWS-6-516 | 11 | CLWU-650 | 36 | CPML Series | 363 |
| CLWS-8-10 | 11 | CLWU-700 | 36 | CPM Series | 363 |
| CLWS-8-14 | 11 | CLWU-750 | 36 | CRA-1/0-12M | 44 |
| CLWS-8-38 | 11 | CLWU-1000 | 36 | CRA-1/0-14M | 44 |
| CLWS-8-516 | 11 | CO3RP | 194 | CRA-1/0-38M | 44 |
| CLWS-250-12 | 12 | CO3SP | 194 | CRA-1/0-516M | 44 |
| CLWS-250-38 | 12 | CO4CW | 194 | CRA-1-12M | 44 |
| CLWS-250-516 | 12 | CO4SP | 194 | CRA-1-14M | 44 |
| CLWS-300-12 | 12 | CO5SP | 195 | CRA-1-38M | 44 |
| CLWS-300-38 | 12 | CO6RP | 195 | CRA-1-516M | 44 |
| CLWS-300-516 | 12 | CO7 | 195 | CRA-2/0-12M | 44 |
| CLWS-350-12 | 12 | CP-0 | 193 | CRA-2/0-14M | 44 |
| CLWS-350-12 | 12 | CP-4 | 193 | CRA-2/0-38-M | 44 |
| CLWS-350-38 | 12 | CP-8 | 193 | CRA-2/0-516M | 44 |
| CLWS-350-38 | 12 | CP-250 | 193 | CRA-2-12M | 43 |
| CLWS-350-58 | 12 | CP-500*+ | 193 | CRA-2-14M | 43 |
| CLWS-400-12 | 12 | CP-1000*+ | 193 | CRA-2-38M | 43 |
| CLWS-400-38 | 12 | CPM-1 | 60 | CRA-2-516M | 43 |
| CLWS-400-58 | 12 | CPM-1 | 60 | CRA-3/0-12M | 44 |
| CLWS-500-12 | 13 | CPM-1/0 | 60 | CRA-3/0-38M | 44 |
| CLWS-500-38 | 13 | CPM-2 | 60 | CRA-4/0-12M | 44 |
| CLWS-500-58 | 13 | CPM-2 | 60 | CRA-4/0-38M | 44 |
| CLWS-600-12 | 13 | CPM-2/0 | 60 | CRA-4-10M | 43 |
| CLWS-600-38 | 13 | CPM-2/0 | 60 | CRA-4-12M | 43 |
| CLWS-600-58 | 13 | CPM-3/0 | 60 | CRA-4-14M | 43 |
| CLWS-650-12 | 13 | CPM-3/0 | 60 | CRA-4-38M | 43 |
| CLWS-650-38 | 13 | CPM-4 | 60 | CRA-4-516M | 43 |
| CLWS-650-58 | 13 | CPM-4 | 60 | CRA-6-10M | 43 |
| CLWS-650-516 | 13 | CPM-4/0 | 61 | CRA-6-12M | 43 |
| CLWS-700-12 | 13 | CPM-4/0 | 61 | CRA-6-14M | 43 |
| CLWS-700-38 | 13 | CPM-6 | 60 | CRA-6-38M | 43 |
| CLWS-700-58 | 13 | CPM-6 | 60 | CRA-6-516-M | 43 |
| CLWS-750-12 | 13 | CPM-250 | 61 | CRA-8-8/10M | 43 |

Alpha Numeric Index

| CATALOG NO. | PAGE NO. | CATALOG NO. | PAGE NO. | CATALOG NO. | PAGE NO. |
|----------------------|----------|-----------------------|----------|-----------------------|----------|
| CRA-8-12M..... | 43 | CSWD-3-38-34 | 6 | CSWD-350-38-1 | 9 |
| CRA-8-14M..... | 43 | CSWD-3-516-1..... | 6 | CSWD-350-516-134..... | 9 |
| CRA-8-38M..... | 43 | CSWD-4/0-12-1..... | 8 | CSWD-400-12-134..... | 9 |
| CRA-8-516M..... | 43 | CSWD-4/0-12-114..... | 8 | CSWD-400-38-1 | 9 |
| CSBS-10-P25..... | 125 | CSWD-4/0-12-134..... | 8 | CSWD-400-38-116..... | 9 |
| CSBS-14-P50..... | 125 | CSWD-4/0-14-1..... | 8 | CSWD-500-12-114..... | 9 |
| CSBS-18-P50..... | 125 | CSWD-4/0-14-34..... | 8 | CSWD-500-12-134..... | 9 |
| CSWD-1/0-12-1..... | 7 | CSWD-4/0-14-58..... | 8 | CSWD-500-14-34 | 9 |
| CSWD-1/0-12-134..... | 7 | CSWD-4/0-38-1..... | 8 | CSWD-500-38-1 | 9 |
| CSWD-1/0-14-1..... | 7 | CSWD-4/0-38-134..... | 8 | CSWD-600-12-134..... | 10 |
| CSWD-1/0-14-34..... | 7 | CSWD-4/0-516-1..... | 8 | CSWD-600-38-1 | 10 |
| CSWD-1/0-14-58..... | 7 | CSWD-4/0-516-34..... | 8 | CSWD-650-12-114..... | 10 |
| CSWD-1/0-38-1..... | 7 | CSWD-4/0-516-134..... | 8 | CSWD-650-12-134..... | 10 |
| CSWD-1/0-38-134..... | 7 | CSWD-4-10-1..... | 6 | CSWD-650-38-1 | 10 |
| CSWD-1/0-516-1..... | 7 | CSWD-4-10-34..... | 6 | CSWD-650-38-118..... | 10 |
| CSWD-1/0-516-34..... | 7 | CSWD-4-10-58..... | 6 | CSWD-650-516-1 | 10 |
| CSWD-1/0-516-78..... | 7 | CSWD-4-12-134..... | 6 | CSWD-700-12-114..... | 10 |
| CSWD-1-12-134..... | 7 | CSWD-4-14-1..... | 6 | CSWD-700-12-134..... | 10 |
| CSWD-1-14-1..... | 7 | CSWD-4-14-34..... | 6 | CSWD-700-12-178..... | 10 |
| CSWD-1-14-34..... | 7 | CSWD-4-14-58..... | 6 | CSWD-700-38-1 | 10 |
| CSWD-1-14-58..... | 7 | CSWD-4-38-1..... | 6 | CSWD-750-12-112..... | 10 |
| CSWD-1-38-1..... | 7 | CSWD-4-38-34..... | 6 | CSWD-750-12-134..... | 10 |
| CSWD-1-516-1..... | 7 | CSWD-4-516-1..... | 6 | CSWD-750-38-1 | 10 |
| CSWD-1-516-78..... | 7 | CSWD-6-10-12..... | 5 | CSWD-750-38-118..... | 10 |
| CSWD-2/0-12-1..... | 8 | CSWD-6-10-34..... | 5 | CSWD-750-58-112..... | 10 |
| CSWD-2/0-12-134..... | 8 | CSWD-6-10-58..... | 5 | CSWD-1000-12-114..... | 10 |
| CSWD-2/0-14-1..... | 8 | CSWD-6-10-1116..... | 5 | CSWD-1000-12-134..... | 10 |
| CSWD-2/0-14-34..... | 8 | CSWD-6-12-134..... | 5 | CSWD-1000-38-1 | 10 |
| CSWD-2/0-14-58..... | 8 | CSWD-6-14-1..... | 5 | CSWD-1000-58-112..... | 10 |
| CSWD-2/0-38-1..... | 8 | CSWD-6-14-12..... | 5 | CSWN-1/0-516..... | 32 |
| CSWD-2/0-38-134..... | 8 | CSWD-6-14-34..... | 5 | CSWN-1-14..... | 32 |
| CSWD-2/0-516-1..... | 8 | CSWD-6-14-58..... | 5 | CSWN-2/0-516..... | 32 |
| CSWD-2/0-516-78..... | 8 | CSWD-6-38-1..... | 5 | CSWN-2-14..... | 32 |
| CSWD-2-10-34..... | 7 | CSWD-6-38-34..... | 5 | CSWN-2-14-58..... | 32 |
| CSWD-2-12-134..... | 7 | CSWD-6-38-78..... | 5 | CSWN-3/0-38..... | 32 |
| CSWD-2-14-1..... | 7 | CSWD-6-516-1..... | 5 | CSWN-4/0-38..... | 32 |
| CSWD-2-14-34..... | 7 | CSWD-6-516-34..... | 5 | CSWN-250-38-1..... | 32 |
| CSWD-2-14-58..... | 7 | CSWD-8-10-34..... | 5 | CSWN-350-38..... | 32 |
| CSWD-2-38-1..... | 7 | CSWD-8-10-58..... | 5 | CSWN-350-38-1..... | 32 |
| CSWD-2-38-34..... | 7 | CSWD-8-14-1..... | 5 | CSWN-500-38..... | 32 |
| CSWD-2-38-78..... | 7 | CSWD-8-14-34..... | 5 | CSWN-600-38..... | 32 |
| CSWD-2-38-134..... | 7 | CSWD-8-14-58..... | 5 | CSWN-750-38-1..... | 32 |
| CSWD-2-516-1..... | 7 | CSWD-8-38-1..... | 5 | CSWN-1000-12-134..... | 32 |
| CSWD-2-516-34..... | 7 | CSWD-250-12-114..... | 9 | CSWN-1000-38-1..... | 32 |
| CSWD-3/0-12-134..... | 8 | CSWD-250-12-134..... | 9 | CSWS-1/0-10..... | 2 |
| CSWD-3/0-14-34..... | 8 | CSWD-250-14-34..... | 9 | CSWS-1/0-12..... | 2 |
| CSWD-3/0-14-58..... | 8 | CSWD-250-38-1..... | 9 | CSWS-1/0-14..... | 2 |
| CSWD-3/0-38-1..... | 8 | CSWD-250-38-134..... | 9 | CSWS-1/0-38..... | 2 |
| CSWD-3/0-516-1..... | 8 | CSWD-300-12-134..... | 9 | CSWS-1/0-516..... | 2 |
| CSWD-3-12-134..... | 6 | CSWD-300-38-1..... | 9 | CSWS-1-10..... | 2 |
| CSWD-3-14-34..... | 6 | CSWD-350-12-114..... | 9 | CSWS-1-12..... | 2 |
| CSWD-3-14-58..... | 6 | CSWD-350-12-134..... | 9 | CSWS-1-14..... | 2 |
| CSWD-3-38-1..... | 6 | CSWD-350-14-34..... | 9 | CSWS-1-38..... | 2 |

Alpha Numeric Index

| CATALOG NO. | PAGE NO. | CATALOG NO. | PAGE NO. | CATALOG NO. | PAGE NO. |
|--------------|----------|--------------|----------|---------------|----------|
| CSWS-1-516 | 2 | CSWS500-38 | 4 | CTL-600 | 47 |
| CSWS-2/0-10 | 3 | CSWS-500-58 | 4 | CTL-650 | 47 |
| CSWS-2/0-12 | 3 | CSWS-600-12 | 4 | CTL-700 | 47 |
| CSWS-2/0-14 | 3 | CSWS-600-38 | 4 | CTL-750 | 47 |
| CSWS-2/0-38 | 3 | CSWS-600-58 | 4 | CTL-1000 | 47 |
| CSWS-2/0-516 | 3 | CSWS-650-12 | 4 | D167-4 | 205 |
| CSWS-2-10 | 2 | CSWS-650-38 | 4 | D167-4 | 283 |
| CSWS-2-12 | 2 | CSWS-650-58 | 4 | D167-4 | 411 |
| CSWS-2-14 | 2 | CSWS-650-516 | 4 | D167-6 | 205 |
| CSWS-2-38 | 2 | CSWS-700-12 | 4 | D167-6 | 283 |
| CSWS-2-516 | 2 | CSWS-700-38 | 4 | D167-6 | 411 |
| CSWS-3/0-10 | 3 | CSWS-700-58 | 4 | D167-8 | 205 |
| CSWS-3/0-12 | 3 | CSWS-750-12 | 4 | D167-8 | 283 |
| CSWS-3/0-14 | 3 | CSWS-750-38 | 4 | D167-8 | 411 |
| CSWS-3/0-38 | 3 | CSWS-750-58 | 4 | D167-10 | 205 |
| CSWS-3/0-516 | 3 | CSWS-1000-12 | 4 | D167-10 | 283 |
| CSWS-3-10 | 2 | CSWS-1000-38 | 4 | D167-10 | 411 |
| CSWS-3-12 | 2 | CSWS-1000-58 | 4 | D167-12 | 205 |
| CSWS-3-14 | 2 | CT-1 | 46 | D167-12 | 283 |
| CSWS-3-38 | 2 | CT-1/0 | 46 | D167-12 | 411 |
| CSWS-3-516 | 2 | CT-2 | 46 | D167-14 | 205 |
| CSWS-4/0-12 | 3 | CT-2/0 | 46 | D167-14 | 283 |
| CSWS-4/0-14 | 3 | CT-3 | 46 | D167-14 | 411 |
| CSWS-4/0-38 | 3 | CT-3/0 | 46 | DBA-2/0 | 135 |
| CSWS-4/0-516 | 3 | CT-4 | 46 | DBA-2/0S | 135 |
| CSWS-4-10 | 2 | CT-4/0 | 46 | DBA-250 | 135 |
| CSWS-4-12 | 2 | CT-6 | 46 | DBA-250S | 135 |
| CSWS-4-14 | 2 | CT-8 | 46 | DBA-350 | 135 |
| CSWS-4-38 | 2 | CT-250 | 46 | DBA-350S | 135 |
| CSWS-4-516 | 2 | CT-300 | 46 | DBA-500 | 135 |
| CSWS-6-10 | 2 | CT-350 | 46 | DBA-500S | 135 |
| CSWS-6-12 | 2 | CT-400 | 46 | DBA-800 | 135 |
| CSWS-6-14 | 2 | CT-500 | 46 | DBA-800S | 135 |
| CSWS-6-38 | 2 | CT-600 | 46 | DBA-1000 | 135 |
| CSWS-6-516 | 2 | CT-650 | 46 | DBA-1000S | 135 |
| CSWS-8-10 | 2 | CT-700 | 46 | DBK-1 | 319 |
| CSWS-8-14 | 2 | CT-750 | 46 | DBK-2 | 319 |
| CSWS-8-38 | 2 | CT-1000 | 46 | DBK-250 | 319 |
| CSWS-8-516 | 2 | CTL-1 | 47 | DBU-112A-350 | 253 |
| CSWS-250-12 | 3 | CTL-1/0 | 47 | DE-18-400-CU† | 247 |
| CSWS-250-38 | 3 | CTL-2 | 47 | De-Ox-1GAL | 414 |
| CSWS-250-516 | 3 | CTL-2/0 | 47 | De-Ox-1OZ | 414 |
| CSWS-300-12 | 3 | CTL-3 | 47 | De-Ox-4OZ | 414 |
| CSWS-300-38 | 3 | CTL-3/0 | 47 | De-Ox-5CC | 414 |
| CSWS-300-58 | 3 | CTL-4 | 47 | De-Ox-5CC-B4 | 414 |
| CSWS-300-516 | 3 | CTL-4/0 | 47 | De-Ox-5GAL | 414 |
| CSWS-350-12 | 3 | CTL-6 | 47 | De-Ox-8OZ | 414 |
| CSWS-350-38 | 3 | CTL-8 | 47 | De-Ox-C-1GAL | 414 |
| CSWS-350-58 | 3 | CTL-250 | 47 | De-Ox-C-1OZ | 414 |
| CSWS-400-12 | 3 | CTL-300 | 47 | De-Ox-C-4OZ | 414 |
| CSWS-400-38 | 3 | CTL-350 | 47 | De-Ox-C-5CC | 414 |
| CSWS-400-58 | 3 | CTL-400 | 47 | De-Ox-C-5GAL | 414 |
| CSWS-500-12 | 4 | CTL-500 | 47 | De-Ox-C-8OZ | 414 |

Alpha Numeric Index

| CATALOG NO. | PAGE NO. | CATALOG NO. | PAGE NO. | CATALOG NO. | PAGE NO. |
|--------------------|----------|---------------------|----------|---------------------|----------|
| De-Ox-Z-1GAL..... | 414 | ECTD-5-250..... | 236 | ECTD-11-750..... | 237 |
| De-Ox-Z-10Z..... | 414 | ECTD-5-250-SR..... | 238 | ECTD-12-1/0..... | 235 |
| De-Ox-Z-40Z..... | 414 | ECTD-5-350..... | 236 | ECTD-12-3/0..... | 235 |
| De-Ox-Z-5CC..... | 414 | ECTD-5-600..... | 237 | ECTD-12-4..... | 235 |
| De-Ox-Z-5GAL..... | 414 | ECTD-5-750..... | 237 | ECTD-12-250..... | 236 |
| De-Ox-Z-80Z..... | 414 | ECTD-6-1/0..... | 235 | ECTD-12-250-SR..... | 238 |
| DS-1..... | 415 | ECTD-6-3/0..... | 235 | ECTD-12-350..... | 236 |
| DS-5..... | 415 | ECTD-6-4..... | 235 | ECTD-12-600..... | 237 |
| E-35..... | 188 | ECTD-6-250..... | 236 | ECTD-12-750..... | 237 |
| E-70..... | 188 | ECTD-6-250-SR..... | 238 | ECTD-13-1/0..... | 235 |
| E-125..... | 188 | ECTD-6-350..... | 236 | ECTD-13-3/0..... | 235 |
| E-153..... | 206 | ECTD-6-600..... | 237 | ECTD-13-4..... | 235 |
| E-153..... | 284 | ECTD-6-750..... | 237 | ECTD-13-250..... | 236 |
| E-153..... | 412 | ECTD-7-1/0..... | 235 | ECTD-13-250-SR..... | 238 |
| E-223..... | 206 | ECTD-7-3/0..... | 235 | ECTD-13-350..... | 236 |
| E-223..... | 284 | ECTD-7-4..... | 235 | ECTD-13-600..... | 237 |
| E-223..... | 412 | ECTD-7-250..... | 236 | ECTD-13-750..... | 237 |
| E-225..... | 188 | ECTD-7-250-SR..... | 238 | ECTD-14-1/0..... | 235 |
| E-300..... | 188 | ECTD-7-350..... | 236 | ECTD-14-3/0..... | 235 |
| E-400..... | 188 | ECTD-7-600..... | 237 | ECTD-14-4..... | 235 |
| E-650..... | 188 | ECTD-7-750..... | 237 | ECTD-14-250..... | 236 |
| ECT-1/0..... | 231 | ECTD-8-1/0..... | 235 | ECTD-14-250-SR..... | 238 |
| ECT-250..... | 231 | ECTD-8-3/0..... | 235 | ECTD-14-350..... | 236 |
| ECT-350..... | 231 | ECTD-8-4..... | 235 | ECTD-14-600..... | 237 |
| ECT-500..... | 231 | ECTD-8-250..... | 236 | ECTD-14-750..... | 237 |
| ECT-750..... | 231 | ECTD-8-250-SR..... | 238 | ECTO-1/0..... | 231 |
| ECTD-2-1/0..... | 235 | ECTD-8-350..... | 236 | ECTO-3/0..... | 231 |
| ECTD-2-3/0..... | 235 | ECTD-8-600..... | 237 | ECTO-4..... | 231 |
| ECTD-2-4..... | 235 | ECTD-8-750..... | 237 | ECTS-2-1/0..... | 232 |
| ECTD-2-250..... | 236 | ECTD-9-1/0..... | 235 | ECTS-2-3/0..... | 232 |
| ECTD-2-350..... | 236 | ECTD-9-3/0..... | 235 | ECTS-2-4..... | 232 |
| ECTD-2-600..... | 237 | ECTD-9-4..... | 235 | ECTS-2-250..... | 233 |
| ECTD-2-750..... | 237 | ECTD-9-250..... | 236 | ECTS-2-350..... | 233 |
| ECTD-3-1/0..... | 235 | ECTD-9-250-SR..... | 238 | ECTS-2-600..... | 234 |
| ECTD-3-3/0..... | 235 | ECTD-9-350..... | 236 | ECTS-2-750..... | 234 |
| ECTD-3-4..... | 235 | ECTD-9-600..... | 237 | ECTS-3-1/0..... | 232 |
| ECTD-3-250..... | 236 | ECTD-9-750..... | 237 | ECTS-3-3/0..... | 232 |
| ECTD-3-250-SR..... | 238 | ECTD-10-1/0..... | 235 | ECTS-3-4..... | 232 |
| ECTD-3-350..... | 236 | ECTD-10-3/0..... | 235 | ECTS-3-250..... | 233 |
| ECTD-3-600..... | 237 | ECTD-10-4..... | 235 | ECTS-3-350..... | 233 |
| ECTD-3-750..... | 237 | ECTD-10-250..... | 236 | ECTS-3-600..... | 234 |
| ECTD-4-1/0..... | 235 | ECTD-10-250-SR..... | 238 | ECTS-3-750..... | 234 |
| ECTD-4-3/0..... | 235 | ECTD-10-350..... | 236 | ECTS-4-1/0..... | 232 |
| ECTD-4-4..... | 235 | ECTD-10-600..... | 237 | ECTS-4-3/0..... | 232 |
| ECTD-4-250..... | 236 | ECTD-10-750..... | 237 | ECTS-4-4..... | 232 |
| ECTD-4-250-SR..... | 238 | ECTD-11-1/0..... | 235 | ECTS-4-250..... | 233 |
| ECTD-4-350..... | 236 | ECTD-11-3/0..... | 235 | ECTS-4-350..... | 233 |
| ECTD-4-600..... | 237 | ECTD-11-4..... | 235 | ECTS-4-600..... | 234 |
| ECTD-4-750..... | 237 | ECTD-11-250..... | 236 | ECTS-4-750..... | 234 |
| ECTD-5-1/0..... | 235 | ECTD-11-250-SR..... | 238 | ECTS-5-1/0..... | 232 |
| ECTD-5-3/0..... | 235 | ECTD-11-350..... | 236 | ECTS-5-3/0..... | 232 |
| ECTD-5-4..... | 235 | ECTD-11-600..... | 237 | ECTS-5-4..... | 232 |

Alpha Numeric Index

| CATALOG NO. | PAGE NO. | CATALOG NO. | PAGE NO. | CATALOG NO. | PAGE NO. |
|-------------|----------|-------------|----------|-------------|----------|
| ECTS-5-250 | 233 | ECTS-13-1/0 | 232 | FX-B3G**T12 | 316 |
| ECTS-5-350 | 233 | ECTS-13-3/0 | 232 | FX-B4D** | 317 |
| ECTS-5-600 | 234 | ECTS-13-4 | 232 | FX-B4D**N | 317 |
| ECTS-5-750 | 234 | ECTS-13-250 | 233 | FX-B4D**T12 | 316 |
| ECTS-6-1/0 | 232 | ECTS-13-350 | 233 | FX-B4E** | 317 |
| ECTS-6-3/0 | 232 | ECTS-13-600 | 234 | FX-B4E**N | 317 |
| ECTS-6-4 | 232 | ECTS-13-750 | 234 | FX-B4E**T12 | 316 |
| ECTS-6-250 | 233 | ECTS-14-1/0 | 232 | FX-B4F** | 317 |
| ECTS-6-350 | 233 | ECTS-14-3/0 | 232 | FX-B4F**N | 317 |
| ECTS-6-600 | 234 | ECTS-14-4 | 232 | FX-B4F**T12 | 316 |
| ECTS-6-750 | 234 | ECTS-14-250 | 233 | FX-B4G** | 317 |
| ECTS-7-1/0 | 232 | ECTS-14-350 | 233 | FX-B4G**N | 317 |
| ECTS-7-3/0 | 232 | ECTS-14-600 | 234 | FX-B4G**T12 | 316 |
| ECTS-7-4 | 232 | ECTS-14-750 | 234 | FX-BD** | 317 |
| ECTS-7-250 | 233 | F2C-1/0-1/0 | 59 | FX-BD06T14 | 316 |
| ECTS-7-350 | 233 | F2C-1-1 | 59 | FX-BD09T14 | 316 |
| ECTS-7-600 | 234 | F2C-2/0-2/0 | 59 | FX-BD10T14 | 316 |
| ECTS-7-750 | 234 | F2C-2-2 | 59 | FX-BD12T14 | 316 |
| ECTS-8-1/0 | 232 | F2C-3/0-3/0 | 59 | FX-BD14T14 | 316 |
| ECTS-8-3/0 | 232 | F2C-4/0-4/0 | 59 | FX-BD**N | 317 |
| ECTS-8-4 | 232 | F2C-4-4 | 59 | FX-BD**T12 | 316 |
| ECTS-8-250 | 233 | F2C-250-250 | 59 | FX-BE** | 317 |
| ECTS-8-350 | 233 | F2C-262-250 | 59 | FX-BE06T716 | 316 |
| ECTS-8-600 | 234 | F2C-313-350 | 59 | FX-BE12T58 | 316 |
| ECTS-8-750 | 234 | F2C-373-350 | 59 | FX-BE12T716 | 316 |
| ECTS-9-1/0 | 232 | F2C-444-500 | 59 | FX-BE18T58 | 316 |
| ECTS-9-3/0 | 232 | F2C-535-500 | 59 | FX-BE18T716 | 316 |
| ECTS-9-4 | 232 | F2C-646-600 | 59 | FX-BE24T58 | 316 |
| ECTS-9-250 | 233 | F2C-777-750 | 59 | FX-BE**N | 317 |
| ECTS-9-350 | 233 | FP-PMP | 374 | FX-BE**T12 | 316 |
| ECTS-9-600 | 234 | FX-B2D** | 317 | FX-BF** | 317 |
| ECTS-9-750 | 234 | FX-B2D**N | 317 | FX-BF06T716 | 316 |
| ECTS-10-1/0 | 232 | FX-B2D**T12 | 316 | FX-BF12T716 | 316 |
| ECTS-10-3/0 | 232 | FX-B2E** | 317 | FX-BF18T716 | 316 |
| ECTS-10-4 | 232 | FX-B2E**N | 317 | FX-BF**N | 317 |
| ECTS-10-250 | 233 | FX-B2E**T12 | 316 | FX-BF**T12 | 316 |
| ECTS-10-350 | 233 | FX-B2F** | 317 | FX-BG** | 317 |
| ECTS-10-600 | 234 | FX-B2F**N | 317 | FX-BG06T716 | 316 |
| ECTS-10-750 | 234 | FX-B2F**T12 | 316 | FX-BG08T716 | 316 |
| ECTS-11-1/0 | 232 | FX-B2G** | 317 | FX-BG12T716 | 316 |
| ECTS-11-3/0 | 232 | FX-B2G**N | 317 | FX-BG**N | 317 |
| ECTS-11-4 | 232 | FX-B2G**T12 | 316 | FX-BG**T12 | 316 |
| ECTS-11-250 | 233 | FX-B3D** | 317 | GBL-1/0 | 286 |
| ECTS-11-350 | 233 | FX-B3D**N | 317 | * GBL-4 | 286 |
| ECTS-11-600 | 234 | FX-B3D**T12 | 316 | GBL-250 | 286 |
| ECTS-11-750 | 234 | FX-B3E** | 317 | GGB-5 | 268 |
| ECTS-12-1/0 | 232 | FX-B3E**N | 317 | GGB-5 | 269 |
| ECTS-12-3/0 | 232 | FX-B3E**T12 | 316 | GGB-5 | 328 |
| ECTS-12-4 | 232 | FX-B3F** | 317 | GGB-6 | 268 |
| ECTS-12-250 | 233 | FX-B3F**N | 317 | GGB-6 | 269 |
| ECTS-12-350 | 233 | FX-B3F**T12 | 316 | GGB-6 | 328 |
| ECTS-12-600 | 234 | FX-B3G** | 317 | GGB-6TN | 268 |
| ECTS-12-750 | 234 | FX-B3G**N | 317 | GGB-6TN | 269 |

Alpha Numeric Index

| CATALOG NO. | PAGE NO. | CATALOG NO. | PAGE NO. | CATALOG NO. | PAGE NO. |
|-------------|----------|------------------|----------|-----------------|----------|
| GGB-6TN | 328 | GRF-500 | 186 | GT-30* | 292 |
| GH-6 | 168 | GRF-500 | 287 | GT-31* | 170 |
| GH-6 | 288 | GRM-2B | 186 | GT-31* | 292 |
| GHS-1* | 168 | GRM-2B | 287 | GT-32* | 170 |
| GHS-1* | 288 | GS-4 | 282 | GT-32* | 292 |
| GHS-5 | 168 | GS-10 | 282 | GT-37* | 170 |
| GHS-5 | 288 | GS-40 | 282 | GT-37* | 292 |
| GMS-6* | 169 | GSE-C1 | 293 | GT-38* | 170 |
| GMS-6* | 289 | GT2-250-W/C | 138 | GT-38* | 292 |
| GO-1 | 290 | GT2-250-W/C | 140 | GT-43* | 170 |
| GO-3 | 290 | GT2-250-W/C | 161 | GT-43* | 292 |
| GO-6 | 290 | GT-3* | 170 | GT-44* | 170 |
| GO-7 | 290 | GT-3* | 292 | GT-44* | 292 |
| GO-8 | 290 | GT-4* | 170 | GT-49* | 170 |
| GO-10 | 290 | GT-4* | 292 | GT-49* | 292 |
| GO-11 | 290 | GT4T-250-2-1* | 139 | GT-50* | 170 |
| GO-12 | 290 | GT4T-250-2-1* | 162 | GT-50* | 292 |
| GO-13 | 290 | GT4T-250-2-2* | 139 | GT-55* | 170 |
| GO-15 | 290 | GT4T-250-2-2* | 162 | GT-55* | 292 |
| GO-16 | 290 | GT4T-250-2-2-W/C | 140 | GTA-0-0 | 158 |
| GO-19 | 290 | GT4T-350-2-1† | 139 | GTA-0-0-W/C | 140 |
| GPL-17 | 280 | GT4T-350-2-1† | 162 | GTA-2-2 | 158 |
| GPL-23 | 280 | GT4T-350-2-2* | 139 | GTA-2-2-W/C | 140 |
| GPL-71 | 281 | GT4T-350-2-2* | 162 | GTA-250-0 | 158 |
| GR-7* | 291 | GT4T-350-2-2-W/C | 140 | GTA-250-0-W/C | 140 |
| GR-9 | 291 | GT4T-500-0-1† | 139 | GTA-250-250 | 158 |
| GR-11* | 291 | GT4T-500-0-1† | 162 | GTA-250-250-W/C | 140 |
| GR-14 | 291 | GT4T-500-0-2† | 139 | GTA-350-350 | 158 |
| GR-15 | 291 | GT4T-500-0-2† | 162 | GTA-500-500 | 158 |
| GR-16* | 291 | GT4T-500-2-1† | 139 | GTA-750-500 | 158 |
| GR-20 | 291 | GT4T-500-2-1† | 162 | GTA-750-750 | 158 |
| GR-21 | 291 | GT4T-500-2-2† | 139 | GTA-1000-500 | 158 |
| GR-26 | 291 | GT4T-500-2-2† | 162 | GTC-0 | 160 |
| GR-27 | 291 | GT-8* | 170 | GTC-2 | 160 |
| GR-31* | 291 | GT-8* | 292 | GTC-250-350 | 160 |
| GR-33* | 291 | GT-13* | 170 | GTC-500 | 160 |
| GR-38* | 291 | GT-13* | 292 | GTC-750-500 | 160 |
| GR-39* | 291 | GT-14* | 170 | GTPC-750-750* | 160 |
| GR-44* | 291 | GT-14* | 292 | GTT-0-0 | 137 |
| GR-50* | 291 | GT-15* | 170 | GTT-0-0 | 159 |
| GR-61* | 291 | GT-15* | 292 | GTT-0-0-W/C | 140 |
| GR-62* | 291 | GT-18* | 170 | GTT-2-2 | 137 |
| GRF-0 | 186 | GT-18* | 292 | GTT-2-2 | 159 |
| GRF-0 | 287 | GT-19* | 170 | GTT-2-2-W/C | 140 |
| GRF-2A | 186 | GT-19* | 292 | GTT-250-0 | 137 |
| GRF-2A | 287 | GT-20* | 170 | GTT-250-0 | 159 |
| GRF-2B | 186 | GT-20* | 292 | GTT-250-0-W/C | 140 |
| GRF-2B | 287 | GT-25* | 170 | GTT-250-250 | 137 |
| GRF-250B | 186 | GT-25* | 292 | GTT-250-250 | 159 |
| GRF-250B | 287 | GT-26* | 170 | GTT-250-250-W/C | 140 |
| GRF-350 | 186 | GT-26* | 292 | GTT-350-350 | 137 |
| GRF-350 | 287 | GT-30* | 170 | GTT-350-350 | 159 |

Alpha Numeric Index

| CATALOG NO. | PAGE NO. | CATALOG NO. | PAGE NO. | CATALOG NO. | PAGE NO. |
|---------------------|----------|------------------|----------|----------------|----------|
| GTT-500-500..... | 137 | HL75-2N | 201 | IK-3N | 129 |
| GTT-500-500..... | 159 | HSA-5 | 374 | IK-4N | 129 |
| GTT-750-500..... | 137 | HSA-10..... | 374 | IK-6N | 129 |
| GTT-750-500..... | 159 | HSA-15..... | 374 | IK-8N | 129 |
| GTT-750-750..... | 137 | HSA-30..... | 374 | IK-10N..... | 129 |
| GTT-750-750..... | 159 | HSO-5 | 374 | IK-250..... | 128 |
| GTTC-750-750* | 160 | HSO-10..... | 374 | IK-350..... | 128 |
| GU-0*..... | 294 | HSO-15..... | 374 | IK-500..... | 128 |
| GU-1*..... | 294 | HSO-30..... | 374 | IK-750..... | 128 |
| GU-3*..... | 294 | HT-2..... | 73 | IK-1000..... | 128 |
| GU-4*..... | 294 | HT-3..... | 73 | IKB-4/0 +..... | 132 |
| GU-7*..... | 294 | HT-4..... | 73 | IKB-350 +..... | 132 |
| GU-17 | 295 | HT-5..... | 73 | IKB-500..... | 132 |
| GU-19*..... | 295 | HT-6..... | 73 | IKB-800..... | 132 |
| GU-22 | 295 | HT-7..... | 73 | IKB-1000..... | 132 |
| GU-25*..... | 295 | HT-8..... | 73 | IKS-4/0 | 133 |
| GU-28 | 295 | * HT Series..... | 363 | IKS-350..... | 133 |
| GU-34 | 295 | HW-13..... | 398 | IKS-500..... | 133 |
| GWL-1..... | 169 | HW-14..... | 398 | IKS-800..... | 133 |
| GWL-1..... | 289 | I-1306..... | 417 | IKS-1000..... | 133 |
| GWL-2..... | 169 | I-1307..... | 417 | ILD-2..... | 83 |
| GWL-2..... | 289 | I-1414..... | 417 | ILD-2..... | 377 |
| GWL-6..... | 169 | I-2452A..... | 417 | ILD-3..... | 83 |
| GWL-6..... | 289 | IACL-1/0 | 67 | ILD-3..... | 377 |
| GWL-7..... | 169 | IACL-1/0 | 67 | ILD-4..... | 83 |
| GWL-7..... | 289 | IACL-2..... | 67 | ILD-4..... | 377 |
| H2L-13-1 | 203 | IACL-2..... | 67 | ILD-5..... | 83 |
| H2L-21-1 | 203 | IACL-2/0 | 67 | ILD-5..... | 377 |
| H2L-21-2N..... | 203 | IACL-2/0 | 67 | ILD-6..... | 83 |
| H2L-30-2N..... | 203 | IACL-3/0 | 67 | ILD-6..... | 377 |
| H2L-35-2N..... | 203 | IACL-3/0 | 67 | ILD-7..... | 83 |
| H2L-50-2N..... | 203 | IACL-4..... | 67 | ILD-7..... | 377 |
| H2L-75-2N..... | 203 | IACL-4..... | 67 | ILD-8..... | 83 |
| H3L-21-2N..... | 204 | IACL-4/0 | 67 | ILD-8..... | 377 |
| H3L-30-2N..... | 204 | IACL-4/0 | 67 | ILD-9..... | 83 |
| H3L-35-2N..... | 204 | IACL-250..... | 67 | ILD-9..... | 377 |
| H3L-50-2N..... | 204 | IACL-250..... | 67 | ILD-10..... | 83 |
| H-70 | 188 | IACL-300..... | 67 | ILD-10..... | 377 |
| H-400..... | 188 | IACL-300..... | 67 | ILD-11..... | 83 |
| H-650..... | 188 | IACL-350..... | 67 | ILD-11..... | 377 |
| HGSE-020*..... | 293 | IACL-350..... | 67 | ILD-12..... | 83 |
| HGSE-250*..... | 293 | IACL-500..... | 67 | ILD-12..... | 377 |
| HGSE-C1*..... | 293 | IACL-500..... | 67 | ILD-13..... | 83 |
| HL4-1..... | 201 | IACL-600..... | 67 | ILD-13..... | 377 |
| HL8-1..... | 201 | IACL-600..... | 67 | ILD-14..... | 83 |
| HL13-1..... | 201 | IK-1/0N..... | 129 | ILD-14..... | 377 |
| HL21-1..... | 201 | IK-2/0..... | 128 | ILD-15..... | 83 |
| HL30-1..... | 201 | IK-2N..... | 129 | ILD-15..... | 377 |
| HL35-1..... | 201 | IK-3/0..... | 128 | ILD-16..... | 83 |
| HL35-2N..... | 201 | IK3-2..... | 130 | ILD-16..... | 377 |
| HL50-1..... | 201 | IK3-4..... | 130 | ILD-16A..... | 83 |
| HL50-2N..... | 201 | IK3-6..... | 130 | ILD-16A..... | 377 |
| HL75-1..... | 201 | IK3-8..... | 130 | ILD-17..... | 83 |

Alpha Numeric Index

| CATALOG NO. | PAGE NO. | CATALOG NO. | PAGE NO. | CATALOG NO. | PAGE NO. |
|-------------|----------|-------------|----------|--------------|----------|
| ILD-17 | 377 | ILD-300 | 82 | ILD-P302o | 84 |
| ILD-18 | 83 | ILD-300 | 376 | ILD-P302o | 378 |
| ILD-18 | 377 | ILD-324 | 82 | ILD-P998° | 84 |
| ILD-21 | 82 | ILD-324 | 376 | ILD-P998o | 378 |
| ILD-21 | 376 | ILD-346 | 82 | ILD-P999° | 84 |
| ILD-24-1 | 82 | ILD-346 | 376 | ILD-P999o | 378 |
| ILD-24-1 | 376 | ILD-348 | 82 | ILD-P1011o | 378 |
| ILD-29-1 | 82 | ILD-348 | 376 | ILD-P1011° | 84 |
| ILD-29-1 | 376 | ILD-374 | 82 | ILD-PADP | 84 |
| ILD-33 | 82 | ILD-374 | 376 | ILD-PADP | 378 |
| ILD-33 | 376 | ILD-375 | 82 | ILD-Precrimp | 84 |
| ILD-37 | 82 | ILD-375 | 376 | ILD-Precrimp | 378 |
| ILD-37 | 83 | ILD-467 | 82 | ILD-SSP* | 379 |
| ILD-37 | 376 | ILD-467 | 376 | ILD-UADP | 84 |
| ILD-42 | 82 | ILD-470 | 82 | ILD-UADP | 378 |
| ILD-42 | 83 | ILD-470 | 376 | INLINE-CASE | 374 |
| ILD-42 | 376 | ILD-471 | 82 | INS-516K | 306 |
| ILD-45 | 82 | ILD-471 | 376 | INS-516K | 307 |
| ILD-45 | 376 | ILD-472 | 82 | INS-516K | 308 |
| ILD-50 | 82 | ILD-472 | 376 | INS-516K | 309 |
| ILD-50 | 376 | ILD-473 | 82 | IPC-1/0-2 | 136 |
| ILD-54 | 82 | ILD-473 | 376 | IPC-1/0-2 | 166 |
| ILD-54 | 376 | ILD-936 | 82 | IPC-1/0-2 | 243 |
| ILD-62 | 82 | ILD-936 | 376 | IPC-4/0-2/0 | 136 |
| ILD-62 | 376 | ILD-997*+ | 84 | IPC-4/0-2/0 | 166 |
| ILD-66 | 82 | ILD-997*+ | 378 | IPC-4/0-2/0 | 243 |
| ILD-66 | 376 | ILD-998+ | 84 | IPC-4/0-6 | 136 |
| ILD-71 | 82 | ILD-998+ | 378 | IPC-4/0-6 | 166 |
| ILD-71 | 376 | ILD-1011+ | 84 | IPC-4/0-6 | 243 |
| ILD-76 | 82 | ILD-1011+ | 378 | ipc-250-4/0 | 136 |
| ILD-76 | 376 | ILD-ADP | 84 | ipc-250-4/0 | 166 |
| ILD-87 | 82 | ILD-ADP | 378 | ipc-250-4/0 | 243 |
| ILD-87 | 376 | ILD-BG | 84 | ipc-350-4/0 | 136 |
| ILD-94 | 82 | ILD-BG | 378 | ipc-350-4/0 | 166 |
| ILD-94 | 376 | ILD-C*+ | 84 | ipc-350-4/0 | 243 |
| ILD-99 | 82 | ILD-C*+ | 378 | ipc-350-350 | 136 |
| ILD-99 | 376 | ILD-D3** | 84 | ipc-350-350 | 166 |
| ILD-106 | 82 | ILD-D3** | 378 | ipc-350-350 | 243 |
| ILD-106 | 376 | ILD-DINOKIT | 379 | ipc-500-12 | 136 |
| ILD-125 | 82 | ILD-K-840*+ | 84 | ipc-500-12 | 166 |
| ILD-125 | 376 | ILD-K-840*+ | 378 | ipc-500-12 | 243 |
| ILD-162 | 84 | ILD-KR+ | 84 | ipc-500-250 | 136 |
| ILD-162 | 378 | ILD-KR+ | 378 | ipc-500-250 | 166 |
| ILD-238 | 84 | ILD-LS*P* | 379 | ipc-500-250 | 243 |
| ILD-238 | 378 | ILD-N*+ | 84 | ipc-500-500 | 136 |
| ILD-296 | 82 | ILD-N*+ | 378 | ipc-500-500 | 166 |
| ILD-296 | 376 | ILD-NSP | 379 | ipc-500-500 | 243 |
| ILD-297 | 82 | ILD-O* | 84 | ipc-750-500 | 136 |
| ILD-297 | 376 | ILD-O* | 378 | ipc-750-500 | 166 |
| ILD-298 | 82 | ILD-P302 | 84 | ipc-750-500 | 243 |
| ILD-298 | 376 | ILD-P302 | 378 | LDA-11-500 | 257 |
| ILD-299 | 82 | ILD-P302+ | 83 | LDA-16-350 | 257 |
| ILD-299 | 376 | ILD-P302+ | 377 | LDA-16-500 | 257 |

Alpha Numeric Index

| CATALOG NO. | PAGE NO. | CATALOG NO. | PAGE NO. | CATALOG NO. | PAGE NO. |
|---------------|----------|------------------|----------|------------------|----------|
| LDA-22-350 | 257 | LO-600 | 190 | NB-350-24 | 413 |
| LDA-22-500 | 257 | LO-600-S | 191 | NB-350-24-W/R16* | 176 |
| LDA-24-500 | 257 | LO-1000 | 190 | NB-350-24-W/R16* | 297 |
| LDA-26-350 | 257 | LO-1000-S | 191 | NB-350-24-W/R16* | 413 |
| LDA-26-500 | 257 | LS-C1E+ | 171 | NB-350-30 | 176 |
| LDA-112-350 | 257 | LS-C1E+ | 296 | NB-350-30 | 297 |
| LDA-112A-350 | 257 | LSN-2/0N* | 171 | NB-350-30 | 413 |
| LDA-212-4/0 | 257 | LSN-2/0N* | 296 | NB-350-30-W/R16* | 176 |
| LDA-212-500 | 257 | LSN-025N* | 171 | NB-350-30-W/R16* | 297 |
| LDAU-11-500 | 253 | LSN-025N* | 296 | NB-350-30-W/R16* | 413 |
| LDAU-16-350 | 253 | LSN-025NE+ | 171 | NB-350-36 | 176 |
| LDAU-16-500 | 253 | LSN-025NE+ | 296 | NB-350-36 | 297 |
| LDAU-22-350 | 253 | LSN-035N* | 171 | NB-350-36 | 413 |
| LDAU-22-500 | 253 | LSN-035N* | 296 | NB-350-36-W/R16* | 176 |
| LDAU-24-500 | 253 | LSN-035NE+ | 171 | NB-350-36-W/R16* | 297 |
| LDAU-26-350 | 253 | LSN-035NE+ | 296 | NB-350-36-W/R16* | 413 |
| LDAU-26-500 | 253 | LSN-100NE+ | 171 | NB-350-42 | 176 |
| LDAU-112-350 | 253 | LSN-100NE+ | 296 | NB-350-42 | 297 |
| LDAU-112A-350 | 253 | LU-4 | 198 | NB-350-42 | 413 |
| LDAU-212-4/0 | 253 | LU-6 | 198 | NB-350-42-W/R16* | 176 |
| LDAU-212-500 | 253 | LY-250-S+ | 192 | NB-350-42-W/R16* | 297 |
| LDB-11-500 | 257 | LY-600 | 192 | NB-350-42-W/R16* | 413 |
| LDB-16-350 | 257 | LY-600-S | 192 | NBAE-0204-1 | 178 |
| LDB-16-500 | 257 | M2GTT-250-250 | 163 | NBAE-0204-1 | 178 |
| LDB-22-350 | 257 | M2GTT-350-350 | 163 | NBAE-0204-1 | 299 |
| LDB-22-500 | 257 | M2GTT-500-500 | 163 | NBAE-0204-1 | 299 |
| LDB-24-500 | 257 | M3GTT-350-350 | 163 | NBAE-0307-1 | 178 |
| LDB-26-350 | 257 | M3GTT-500-500 | 163 | NBAE-0307-1 | 178 |
| LDB-26-500 | 257 | M-161 | 410 | NBAE-0307-1 | 299 |
| LDB-112-350 | 257 | M-162 | 410 | NBAE-0307-1 | 299 |
| LDB-112A-350 | 257 | M-163 | 410 | NBAE-0409-2 | 178 |
| LDB-212-4/0 | 257 | M-164 | 410 | NBAE-0409-2 | 178 |
| LDB-212-500 | 257 | M-165 | 410 | NBAE-0409-2 | 299 |
| LDBU-11-500 | 253 | M-203-N-09 | 420 | NBAE-0409-2 | 299 |
| LDBU-16-350 | 253 | MAC-618-S-K | 165 | NBAE-0410-1 | 178 |
| LDBU-16-500 | 253 | MAC-618-S-K | 241 | NBAE-0410-1 | 178 |
| LDBU-22-350 | 253 | MAC-618-T-K | 165 | NBAE-0410-1 | 299 |
| LDBU-22-500 | 253 | MAC-618-T-K | 241 | NBAE-0410-1 | 299 |
| LDBU-24-500 | 253 | MU-250 | 198 | NBAE-0512-2 | 178 |
| LDBU-26-350 | 253 | MU-350 | 198 | NBAE-0512-2 | 178 |
| LDBU-26-500 | 253 | MU-600 | 198 | NBAE-0512-2 | 299 |
| LDBU-112-350 | 253 | N-174† | 206 | NBAE-0512-2 | 299 |
| LDBU-212-4/0 | 253 | N-174† | 284 | NBAE-0615-2 | 178 |
| LDBU-212-500 | 253 | N-174† | 412 | NBAE-0615-2 | 178 |
| LO-0 | 190 | NB-350 | 180 | NBAE-0615-2 | 299 |
| LO-0-S | 191 | NB-350-12 | 176 | NBAE-0615-2 | 299 |
| LO-4 | 190 | NB-350-12 | 297 | NBAE-0924-2 | 178 |
| LO-250 | 190 | NB-350-12 | 413 | NBAE-0924-2 | 178 |
| LO-250-S | 191 | NB-350-12-W/R16* | 176 | NBAE-0924-2 | 299 |
| LO-350-S | 191 | NB-350-12-W/R16* | 297 | NBAE-0924-2 | 299 |
| LO-350SH | 190 | NB-350-12-W/R16* | 413 | NBAE-1233-2 | 178 |
| LO-350STD | 190 | NB-350-24 | 176 | NBAE-1233-2 | 178 |
| LO-500 | 190 | NB-350-24 | 297 | NBAE-1233-2 | 299 |

Alpha Numeric Index

| CATALOG NO. | PAGE NO. | CATALOG NO. | PAGE NO. | CATALOG NO. | PAGE NO. |
|--------------------|----------|-----------------------|----------|-----------------------|----------|
| NBAE-1233-2..... | 299 | NBCE-3192-0..... | 300 | NDMTD-14-187-P50..... | 117 |
| NBAE-3192-0..... | 178 | NBFT-10-195-P25..... | 120 | NDMTD-14-250-P50..... | 117 |
| NBAE-3192-0..... | 178 | NBFT-14-156-P50..... | 120 | NDMTD-18-110-P50..... | 117 |
| NBAE-3192-0..... | 299 | NBFT-18-156-P50..... | 120 | NDMTD-18-187-P50..... | 117 |
| NBAE-3192-0..... | 299 | NBFTD-10-195-P25..... | 120 | NDMTD-18-250-P50..... | 117 |
| NBAS..... | 180 | NBFTD-14-156-P50..... | 120 | ND-O..... | 83 |
| NBAS-002-1-A..... | 177 | NBFTD-18-156-P50..... | 120 | ND-O..... | 377 |
| NBAS-002-1-A..... | 298 | NBMT-10-195-P25..... | 120 | NFBR-10-14-P25..... | 113 |
| NBAS-002-1-B..... | 177 | NBMT-14-156-P50..... | 120 | NFBR-14-6-P50..... | 113 |
| NBAS-002-1-B..... | 298 | NBMT-18-156-P50..... | 120 | NFBR-14-14-P50..... | 113 |
| NBAS-003-1-A..... | 177 | NBMTD-10-195-P25..... | 120 | NFBR-18-14-P50..... | 113 |
| NBAS-003-1-A..... | 298 | NBMTD-14-156-P50..... | 120 | NFBRD-10-8-P25..... | 115 |
| NBAS-003-1-B..... | 177 | NBMTD-18-156-P50..... | 120 | NFBRD-10-10-P25..... | 115 |
| NBAS-003-1-B..... | 298 | NBSS-10-P25..... | 124 | NFBRD-10-14-P25..... | 115 |
| NBAS-004-1-B..... | 177 | NBSS-14-P50..... | 124 | NFBRD-14-8-P50..... | 115 |
| NBAS-004-1-B..... | 298 | NBSS-18-P50..... | 124 | NFBRD-14-14-P50..... | 115 |
| NBAS-004-2-B..... | 177 | NBST-2/0..... | 180 | NFBRD-18-6-P50..... | 115 |
| NBAS-004-2-B..... | 298 | NBST-2/0..... | 301 | NFBRD-18-14-P50..... | 115 |
| NBAS-006-1-B..... | 177 | NBW-38-125..... | 416 | NFIDT-14-156-P25..... | 120 |
| NBAS-006-1-B..... | 298 | NBW-50-150..... | 416 | NFIDT-18-156-P25..... | 120 |
| NBAS-008-2-A..... | 177 | NBW-50-200..... | 416 | NFIFT-10-250-P25..... | 118 |
| NBAS-008-2-A..... | 298 | NBW-50-250..... | 416 | NFIFT-14-250-P50..... | 118 |
| NBAS-009-2-A..... | 177 | NBW-58-250..... | 416 | NFIFT-18-250-P50..... | 118 |
| NBAS-009-2-A..... | 298 | NBW-58-300..... | 416 | NFIMT-10-250-P25..... | 118 |
| NBAS-010-1-B..... | 177 | ND-BG..... | 83 | NFIMT-14-250-P25..... | 118 |
| NBAS-010-1-B..... | 298 | ND-BG..... | 377 | NFIMT-18-250-P25..... | 118 |
| NBAS-012-1-B..... | 177 | ND-C..... | 83 | NFL3..... | 325 |
| NBAS-012-1-B..... | 298 | ND-C..... | 377 | NFL3..... | 327 |
| NBAS-012-2-A..... | 177 | NDFT-10-250-P25..... | 116 | NFL6..... | 325 |
| NBAS-012-2-A..... | 298 | NDFT-14-110-P50..... | 116 | NFL6..... | 327 |
| NBAS-013-2-A..... | 177 | NDFT-14-187-P50..... | 116 | NFL24..... | 325 |
| NBAS-013-2-A..... | 298 | NDFT-14-250-P50..... | 116 | NFL24..... | 327 |
| NBAS-014-1-B..... | 177 | NDFT-18-110-P50..... | 116 | NFLB-10-250-P25..... | 119 |
| NBAS-014-1-B..... | 298 | NDFT-18-187-P50..... | 116 | NFLB-14-250-P25..... | 119 |
| NBAS-192-0-A*..... | 177 | NDFT-18-250-P50..... | 116 | NFLB-18-250-P25..... | 119 |
| NBAS-192-0-A*..... | 298 | NDFTD-10-187-P25..... | 116 | NFLBD-10-250-P20..... | 119 |
| NBAS-192-0-B..... | 177 | NDFTD-10-250-P25..... | 116 | NFLBD-14-187-P25..... | 119 |
| NBAS-192-0-B..... | 298 | NDFTD-10-250-P25..... | 118 | NFLBD-14-250-P25..... | 119 |
| NBAS-231-0-A*..... | 177 | NDFTD-14-110-P50..... | 116 | NFLBD-18-187-P25..... | 119 |
| NBAS-231-0-A*..... | 298 | NDFTD-14-187-P50..... | 116 | NFLBD-18-250-P25..... | 119 |
| NBAS-231-0-B..... | 177 | NDFTD-14-250-P50..... | 116 | NPBR-10-551-P25..... | 121 |
| NBAS-231-0-B..... | 298 | NDFTD-18-110-P50..... | 116 | NPBR-14-512-P50..... | 121 |
| NBCE-0305-2..... | 179 | NDFTD-18-187-P50..... | 116 | NPBR-18-512-P50..... | 121 |
| NBCE-0305-2..... | 300 | NDFTD-18-250-P50..... | 116 | NPBRD-10-551-P25..... | 121 |
| NBCE-0305-2..... | 300 | ND-K-840..... | 83 | NPBRD-14-512-P50..... | 121 |
| NBCE-0615-2..... | 179 | ND-K-840..... | 377 | NPBRD-18-512-P50..... | 121 |
| NBCE-0615-2..... | 300 | NDMT-10-250-P25..... | 117 | NRBR-10-6MS-P25..... | 99 |
| NBCE-0615-2..... | 300 | NDMT-14-187-P50..... | 117 | NRBR-10-6-P25..... | 96 |
| NBCE-1336-2..... | 179 | NDMT-14-250-P50..... | 117 | NRBR-10-8-P25..... | 96 |
| NBCE-1336-2..... | 300 | NDMT-18-110-P50..... | 117 | NRBR-10-10-P25..... | 96 |
| NBCE-1336-2..... | 300 | NDMT-18-187-P50..... | 117 | NRBR-10-12-P20..... | 96 |
| NBCE-3192-0..... | 179 | NDMT-18-250-P50..... | 117 | NRBR-10-14-P25..... | 96 |
| NBCE-3192-0..... | 300 | NDMTD-10-250-P25..... | 117 | NRBR-10-38-P25..... | 96 |

Alpha Numeric Index

| CATALOG NO. | PAGE NO. | CATALOG NO. | PAGE NO. | CATALOG NO. | PAGE NO. |
|------------------|----------|------------------|----------|----------------|----------|
| NRBR-10-516-P25 | 96 | NSBRD-10-8-P25 | 103 | PB2-750 | 151 |
| NRBR-14-6MS-P50 | 99 | NSBRD-10-10-P25 | 103 | PB2-750-2N | 151 |
| NRBR-14-6-P50 | 96 | NSBRD-10-14-P25 | 103 | PB3-600 | 151 |
| NRBR-14-8-P50 | 96 | NSBRD-10-516-P25 | 103 | PB3-600-2N | 151 |
| NRBR-14-10-P50 | 96 | NSBRD-14-6-P50 | 103 | PB4-600 | 151 |
| NRBR-14-12-P25 | 96 | NSBRD-14-8-P50 | 103 | PB4-600-2N | 151 |
| NRBR-14-14-P50 | 96 | NSBRD-14-10-P50 | 103 | PB4-750 | 151 |
| NRBR-14-38-P25 | 96 | NSBRD-14-14-P50 | 103 | PB4-750-2N | 151 |
| NRBR-14-516-P50 | 96 | NSBRD-18-6-P50 | 103 | PBHD2-750 | 152 |
| NRBR-18-6MS-P50 | 99 | NSBRD-18-8-P50 | 103 | PBHD4-750 | 152 |
| NRBR-18-6-P50 | 96 | NSBRD-18-10-P50 | 103 | PBHD6-750* | 152 |
| NRBR-18-8-P50 | 96 | NSFBR-10-6-P25 | 109 | PBMW-2-750-12 | 153 |
| NRBR-18-10-P50 | 96 | NSFBR-10-8-P25 | 109 | PBMW-2-750-38 | 153 |
| NRBR-18-14-P50 | 96 | NSFBR-10-10-P25 | 109 | PBMW-4-750-12 | 153 |
| NRBR-18-38-P25 | 96 | NSFBR-14-6-P50 | 109 | PBMW-4-750-38 | 153 |
| NRBR-18-516-P50 | 96 | NSFBR-14-8-P50 | 109 | PBMW-6-750-12 | 153 |
| NRBRD-10-6MS-P25 | 99 | NSFBR-14-10-P50 | 109 | PBMW-6-750-38 | 153 |
| NRBRD-10-6-P25 | 98 | NSFBR-18-6-P50 | 109 | PBT-1/0 | 210 |
| NRBRD-10-8-P25 | 98 | NSFBR-18-8-P50 | 109 | PBT2-4-250-F | 227 |
| NRBRD-10-10-P25 | 98 | NSFBR-18-10-P50 | 109 | PBT2-4-350-F | 227 |
| NRBRD-10-12-P20 | 98 | NSFBRD-10-6-P25 | 111 | PBT2-4-600-F | 227 |
| NRBRD-10-14-P25 | 98 | NSFBRD-10-8-P25 | 111 | PBT2-4-750-F | 227 |
| NRBRD-10-38-P25 | 98 | NSFBRD-10-10-P25 | 111 | PBT2-6-250-F | 227 |
| NRBRD-10-516-P25 | 98 | NSFBRD-14-6-P50 | 111 | PBT2-6-350-F | 227 |
| NRBRD-14-6MS-P50 | 99 | NSFBRD-14-8-P50 | 111 | PBT2-6-600-F | 227 |
| NRBRD-14-6-P50 | 98 | NSFBRD-14-10-P50 | 111 | PBT2-6-750-F | 227 |
| NRBRD-14-8-P50 | 98 | NSFBRD-18-6-P50 | 111 | PBT2-8-250-F | 227 |
| NRBRD-14-10-P50 | 98 | NSFBRD-18-8-P50 | 111 | PBT2-8-350-F | 227 |
| NRBRD-14-12-P50 | 98 | NSFBRD-18-10-P50 | 111 | PBT2-8-600-F | 227 |
| NRBRD-14-14-P50 | 98 | NSLBR-10-6-P25 | 105 | PBT2-8-750-F | 227 |
| NRBRD-14-38-P50 | 98 | NSLBR-10-8-P25 | 105 | PBT2-10-250-F | 227 |
| NRBRD-14-516-P50 | 98 | NSLBR-10-10-P25 | 105 | PBT2-10-350-F | 227 |
| NRBRD-18-6MS-P50 | 99 | NSLBR-10-14-P25 | 105 | PBT2-10-600-F | 227 |
| NRBRD-18-6-P50 | 98 | NSLBR-14-6-P50 | 105 | PBT2-10-750-F | 227 |
| NRBRD-18-8-P50 | 98 | NSLBR-14-8-P50 | 105 | PBT2-12-250-F | 227 |
| NRBRD-18-10-P50 | 98 | NSLBR-14-10-P50 | 105 | PBT2-12-350-F | 227 |
| NRBRD-18-14-P50 | 98 | NSLBR-18-6-P50 | 105 | PBT2-12-600-F | 227 |
| NRBRD-18-38-P50 | 98 | NSLBR-18-8-P50 | 105 | PBT2-12-750-F | 227 |
| NRBRD-18-516-P50 | 98 | NSLBR-18-10-P50 | 105 | PBT-250 | 210 |
| NSBR-10-6-P25 | 102 | NSLBRD-10-6-P25 | 107 | PBT-350 | 210 |
| NSBR-10-8-P25 | 102 | NSLBRD-10-8-P25 | 107 | PBT-500 | 210 |
| NSBR-10-10-P25 | 102 | NSLBRD-10-10-P25 | 107 | PBT-750 | 210 |
| NSBR-10-14-P25 | 102 | NSLBRD-10-14-P25 | 107 | PBTD-2-1/0 | 211 |
| NSBR-10-516-P25 | 102 | NSLBRD-14-6-P50 | 107 | PBTD-2-1/0-F | 222 |
| NSBR-14-6-P50 | 102 | NSLBRD-14-8-P50 | 107 | PBTD-2-3/0 | 211 |
| NSBR-14-8-P50 | 102 | NSLBRD-14-10-P50 | 107 | PBTD-2-3/0-F | 222 |
| NSBR-14-10-P50 | 102 | NSLBRD-18-6-P50 | 107 | PBTD-2-3/0-M | 218 |
| NSBR-14-14-P50 | 102 | NSLBRD-18-8-P50 | 107 | PBTD-2-3/0-M-F | 223 |
| NSBR-18-6-P50 | 102 | NSLBRD-18-10-P50 | 107 | PBTD-2-4 | 211 |
| NSBR-18-8-P50 | 102 | PB2-300 | 151 | PBTD-2-4-F+ | 222 |
| NSBR-18-10-P50 | 102 | PB2-500 | 151 | PBTD-2-250 | 212 |
| NSBR-18-14-P50 | 102 | PB2-600 | 151 | PBTD-2-250-F | 222 |
| NSBRD-10-6-P25 | 103 | PB2-600-2N | 151 | PBTD-2-250-M | 218 |

Alpha Numeric Index

| CATALOG NO. | PAGE NO. | CATALOG NO. | PAGE NO. | CATALOG NO. | PAGE NO. |
|----------------------|----------|----------------------|----------|----------------------|----------|
| PBTD-2-250-M-F | 223 | PBTD-4-350-F | 222 | PBTD-7-4 | 211 |
| PBTD-2-350 | 212 | PBTD-4-350-M | 218 | PBTD-7-250 | 212 |
| PBTD-2-350-F | 222 | PBTD-4-350-M-F | 223 | PBTD-7-250-M | 218 |
| PBTD-2-350-M | 218 | PBTD-4-500 | 213 | PBTD-7-250-SR | 214 |
| PBTD-2-350-M-F | 223 | PBTD-4-500-F | 222 | PBTD-7-350 | 212 |
| PBTD-2-500 | 213 | PBTD-4-500-M | 219 | PBTD-7-350-M | 218 |
| PBTD-2-500-F | 222 | PBTD-4-500-M-F | 223 | PBTD-7-500 | 213 |
| PBTD-2-500-M | 219 | PBTD-4-750 | 213 | PBTD-7-500-M | 219 |
| PBTD-2-500-M-F | 223 | PBTD-4-750-F | 222 | PBTD-7-750 | 213 |
| PBTD-2-750 | 213 | PBTD-4-750-M | 219 | PBTD-7-750-M | 219 |
| PBTD-2-750-F | 222 | PBTD-4-750-M-F | 223 | PBTD-8-1/0 | 211 |
| PBTD-2-750-M | 219 | PBTD-5-1/0 | 211 | PBTD-8-3/0 | 211 |
| PBTD-2-750-M-F | 223 | PBTD-5-3/0 | 211 | PBTD-8-3/0-M | 218 |
| PBTD-3-1/0 | 211 | PBTD-5-3/0-M | 218 | PBTD-8-4 | 211 |
| PBTD-3-1/0-F | 222 | PBTD-5-4 | 211 | PBTD-8-250 | 212 |
| PBTD-3-3/0 | 211 | PBTD-5-250 | 212 | PBTD-8-250-M | 218 |
| PBTD-3-3/0-F | 222 | PBTD-5-250-M | 218 | PBTD-8-250-SR | 214 |
| PBTD-3-3/0-M | 218 | PBTD-5-250-SR | 214 | PBTD-8-350 | 212 |
| PBTD-3-3/0-M-F | 223 | PBTD-5-350 | 212 | PBTD-8-350-M | 218 |
| PBTD-3-4 | 211 | PBTD-5-350-M | 218 | PBTD-8-500 | 213 |
| PBTD-3-4-F | 222 | PBTD-5-500 | 213 | PBTD-8-500-M | 219 |
| PBTD-3-250 | 212 | PBTD-5-500-M | 219 | PBTD-8-750 | 213 |
| PBTD-3-250-F | 222 | PBTD-5-750 | 213 | PBTD-8-750-M | 219 |
| PBTD-3-250-M | 218 | PBTD-5-750-M | 219 | PBTD-9-1/0 | 211 |
| PBTD-3-250-M-F | 223 | PBTD-6-1/0 | 211 | PBTD-9-3/0 | 211 |
| PBTD-3-250-SR | 214 | PBTD-6-1/0-F | 222 | PBTD-9-3/0-M | 218 |
| PBTD-3-350 | 212 | PBTD-6-3/0 | 211 | PBTD-9-4 | 211 |
| PBTD-3-350-F | 222 | PBTD-6-3/0-F | 222 | PBTD-9-250 | 212 |
| PBTD-3-350-M | 218 | PBTD-6-3/0-M | 218 | PBTD-9-250-M | 218 |
| PBTD-3-350-M-F | 223 | PBTD-6-3/0-M-F | 223 | PBTD-9-250-SR | 214 |
| PBTD-3-500 | 213 | PBTD-6-4 | 211 | PBTD-9-350 | 212 |
| PBTD-3-500-F | 222 | PBTD-6-4-F | 222 | PBTD-9-350-M | 218 |
| PBTD-3-500-M | 219 | PBTD-6-250 | 212 | PBTD-9-500 | 213 |
| PBTD-3-500-M-F | 223 | PBTD-6-250-F | 222 | PBTD-9-500-M | 219 |
| PBTD-3-750 | 213 | PBTD-6-250-M | 218 | PBTD-9-750 | 213 |
| PBTD-3-750-F | 222 | PBTD-6-250-M-F | 223 | PBTD-9-750-M | 219 |
| PBTD-3-750-M | 219 | PBTD-6-250-SR | 214 | PBTD-10-1/0 | 211 |
| PBTD-3-750-M-F | 223 | PBTD-6-350 | 212 | PBTD-10-3/0 | 211 |
| PBTD-4-1/0 | 211 | PBTD-6-350-F | 222 | PBTD-10-3/0-M | 218 |
| PBTD-4-1/0-F | 222 | PBTD-6-350-M | 218 | PBTD-10-4 | 211 |
| PBTD-4-3/0 | 211 | PBTD-6-350-M-F | 223 | PBTD-10-250 | 212 |
| PBTD-4-3/0-F | 222 | PBTD-6-500 | 213 | PBTD-10-250-M | 218 |
| PBTD-4-3/0-M | 218 | PBTD-6-500-F | 222 | PBTD-10-250-SR | 214 |
| PBTD-4-3/0-M-F | 223 | PBTD-6-500-M | 219 | PBTD-10-350 | 212 |
| PBTD-4-4 | 211 | PBTD-6-500-M-F | 223 | PBTD-10-350-M | 218 |
| PBTD-4-4-F | 222 | PBTD-6-750 | 213 | PBTD-10-500 | 213 |
| PBTD-4-250 | 212 | PBTD-6-750-F | 222 | PBTD-10-500-M | 219 |
| PBTD-4-250-F | 222 | PBTD-6-750-M | 219 | PBTD-10-750 | 213 |
| PBTD-4-250-M | 218 | PBTD-6-750-M-F | 223 | PBTD-10-750-M | 219 |
| PBTD-4-250-M-F | 223 | PBTD-7-1/0 | 211 | PBTD-11-1/0 | 211 |
| PBTD-4-250-SR | 214 | PBTD-7-3/0 | 211 | PBTD-11-3/0 | 211 |
| PBTD-4-350 | 212 | PBTD-7-3/0-M | 218 | PBTD-11-3/0-M | 218 |

Alpha Numeric Index

| CATALOG NO. | PAGE NO. | CATALOG NO. | PAGE NO. | CATALOG NO. | PAGE NO. |
|--------------------|----------|------------------|----------|--------------|----------|
| PBTD-11-4 | 211 | PBTFML-4-09-D-L | 229 | PBTS-3-500-F | 221 |
| PBTD-11-250 | 212 | PBTFML-4-09-WD-H | 229 | PBTS-3-750 | 217 |
| PBTD-11-250-M | 218 | PBTFML-4-09-W-L | 229 | PBTS-3-750-F | 221 |
| PBTD-11-250-SR | 214 | PBTFML-4-12-D-H | 229 | PBTS-4-1/0 | 215 |
| PBTD-11-350 | 212 | PBTFML-4-12-D-L | 229 | PBTS-4-1/0-F | 221 |
| PBTD-11-350-M | 218 | PBTFML-4-12-W-H | 229 | PBTS-4-3/0 | 215 |
| PBTD-11-500 | 213 | PBTFML-4-12-W-L | 229 | PBTS-4-3/0-F | 221 |
| PBTD-11-500-M | 219 | PBTI-2-1/0-F* | 228 | PBTS-4-4 | 215 |
| PBTD-11-750 | 213 | PBTI-2-4-F* | 228 | PBTS-4-4-F | 221 |
| PBTD-11-750-M | 219 | PBTI-3-1/0-F* | 228 | PBTS-4-250 | 216 |
| PBTD-12-1/0 | 211 | PBTI-3-4-F* | 228 | PBTS-4-250-F | 221 |
| PBTD-12-3/0 | 211 | PBTI-4-1/0-F* | 228 | PBTS-4-350 | 216 |
| PBTD-12-3/0-M | 218 | PBTI-4-4-F* | 228 | PBTS-4-350-F | 221 |
| PBTD-12-4 | 211 | PBTI-5-1/0-F* | 228 | PBTS-4-500 | 217 |
| PBTD-12-250 | 212 | PBTI-5-4-F* | 228 | PBTS-4-500-F | 221 |
| PBTD-12-250-M | 218 | PBTL-2-350-F | 225 | PBTS-4-750 | 217 |
| PBTD-12-250-SR | 214 | PBTL-2-500-F | 225 | PBTS-4-750-F | 221 |
| PBTD-12-350 | 212 | PBTL-2-750-F | 225 | PBTS-5-1/0 | 215 |
| PBTD-12-350-M | 218 | PBTL-3-350-F | 225 | PBTS-5-3/0 | 215 |
| PBTD-12-500 | 213 | PBTL-3-500-F | 225 | PBTS-5-4 | 215 |
| PBTD-12-500-M | 219 | PBTL-3-750-F | 225 | PBTS-5-250 | 216 |
| PBTD-12-750 | 213 | PBTL-4-350-F | 225 | PBTS-5-350 | 216 |
| PBTD-12-750-M | 219 | PBTL-4-500-F | 225 | PBTS-5-500 | 217 |
| PBTD-13-1/0 | 211 | PBTL-4-750-F | 225 | PBTS-5-750 | 217 |
| PBTD-13-3/0 | 211 | PBTO-1/0 | 210 | PBTS-6-1/0 | 215 |
| PBTD-13-4 | 211 | PBTO-3/0 | 210 | PBTS-6-1/0-F | 221 |
| PBTD-13-250 | 212 | PBTO-4 | 210 | PBTS-6-3/0 | 215 |
| PBTD-13-250-SR | 214 | PBTS-2-1/0 | 215 | PBTS-6-3/0-F | 221 |
| PBTD-13-350 | 212 | PBTS-2-1/0-F | 221 | PBTS-6-4 | 215 |
| PBTD-13-500 | 213 | PBTS-2-3/0 | 215 | PBTS-6-4-F | 221 |
| PBTD-13-750 | 213 | PBTS-2-3/0-F | 221 | PBTS-6-250 | 216 |
| PBTD-14-1/0 | 211 | PBTS-2-4 | 215 | PBTS-6-250-F | 221 |
| PBTD-14-3/0 | 211 | PBTS-2-4-F+ | 221 | PBTS-6-350 | 216 |
| PBTD-14-4 | 211 | PBTS-2-250 | 216 | PBTS-6-350-F | 221 |
| PBTD-14-250 | 212 | PBTS-2-250-F | 221 | PBTS-6-500 | 217 |
| PBTD-14-250-SR | 214 | PBTS-2-350 | 216 | PBTS-6-500-F | 221 |
| PBTD-14-350 | 212 | PBTS-2-350-F | 221 | PBTS-6-750 | 217 |
| PBTD-14-500 | 213 | PBTS-2-500 | 217 | PBTS-6-750-F | 221 |
| PBTD-14-750 | 213 | PBTS-2-500-F | 221 | PBTS-7-1/0 | 215 |
| PBTFML-1/0-03-WD | 229 | PBTS-2-750 | 217 | PBTS-7-3/0 | 215 |
| PBTFML-1/0-06-D | 229 | PBTS-2-750-F | 221 | PBTS-7-4 | 215 |
| PBTFML-1/0-06-W | 229 | PBTS-3-1/0 | 215 | PBTS-7-250 | 216 |
| PBTFML-1/0-09-D-L | 229 | PBTS-3-1/0-F | 221 | PBTS-7-350 | 216 |
| PBTFML-1/0-09-WD-H | 229 | PBTS-3-3/0 | 215 | PBTS-7-500 | 217 |
| PBTFML-1/0-09-W-L | 229 | PBTS-3-3/0-F | 221 | PBTS-7-750 | 217 |
| PBTFML-1/0-12-D-H | 229 | PBTS-3-4 | 215 | PBTS-8-1/0 | 215 |
| PBTFML-1/0-12-D-L | 229 | PBTS-3-4-F | 221 | PBTS-8-3/0 | 215 |
| PBTFML-1/0-12-W-H | 229 | PBTS-3-250 | 216 | PBTS-8-4 | 215 |
| PBTFML-1/0-12-W-L | 229 | PBTS-3-250-F | 221 | PBTS-8-250 | 216 |
| PBTFML-4-03-WD | 229 | PBTS-3-350 | 216 | PBTS-8-350 | 216 |
| PBTFML-4-06-D | 229 | PBTS-3-350-F | 221 | PBTS-8-500 | 217 |
| PBTFML-4-06-W | 229 | PBTS-3-500 | 217 | PBTS-8-750 | 217 |

Alpha Numeric Index

| CATALOG NO. | PAGE NO. | CATALOG NO. | PAGE NO. | CATALOG NO. | PAGE NO. |
|-------------------|----------|-------------------|----------|---------------------|----------|
| PBTS-9-1/0..... | 215 | PCT-2-350 | 239 | PDB-26-2/0-2..... | 259 |
| PBTS-9-3/0..... | 215 | PCT-2-600 | 239 | PDB-26-2/0-3..... | 259 |
| PBTS-9-4..... | 215 | PCT-2-800 | 239 | PDB-26-350-1..... | 260 |
| PBTS-9-250..... | 216 | PCT-4-2/0..... | 239 | PDB-26-350-2..... | 260 |
| PBTS-9-350..... | 216 | PCT-4-4/0..... | 239 | PDB-26-350-3..... | 260 |
| PBTS-9-500..... | 217 | PCT-4-350..... | 239 | PDB-26-500-2..... | |
| PBTS-9-750..... | 217 | PCT-4-600..... | 239 | PDB-26-500-1..... | 260 |
| PBTS-10-1/0..... | 215 | PCT-4-800..... | 239 | PDB-26-500-3..... | 260 |
| PBTS-10-3/0..... | 215 | PCT-6-2/0..... | 239 | PDB-26-750-1..... | 262 |
| PBTS-10-4..... | 215 | PCT-6-4/0..... | 239 | PDB-49-500-1..... | 264 |
| PBTS-10-250..... | 216 | PCT-6-350..... | 239 | ‡ PDB-55-600-1..... | 263 |
| PBTS-10-350..... | 216 | PCT-6-600..... | 239 | PDB-112-350-1..... | 259 |
| PBTS-10-500..... | 217 | PCT-6-800..... | 239 | PDB-112-350-2..... | 259 |
| PBTS-10-750..... | 217 | PCT-8-2/0..... | 239 | PDB-112-350-3..... | 259 |
| PBTS-11-1/0..... | 215 | PCT-8-4/0..... | 239 | PDB-112A-350-1..... | 259 |
| PBTS-11-3/0..... | 215 | PCT-8-350..... | 239 | PDB-112A-350-2..... | 259 |
| PBTS-11-4..... | 215 | PCT-8-600..... | 239 | PDB-112A-350-3..... | 259 |
| PBTS-11-250..... | 216 | PDA-11-2/0-1..... | 258 | PDB-162-500-1..... | 259 |
| PBTS-11-350..... | 216 | PDA-14-2/0-1..... | 258 | PDB-162-500-2..... | 259 |
| PBTS-11-500..... | 217 | PDB-11-2/0-1..... | 261 | PDB-162-500-3..... | 259 |
| PBTS-11-750..... | 217 | PDB-11-2/0-2..... | 261 | PDB-212-4/0-1..... | 260 |
| PBTS-12-1/0..... | 215 | PDB-11-2/0-3..... | 261 | PDB-212-4/0-2..... | 260 |
| PBTS-12-3/0..... | 215 | PDB-11-350-1..... | 261 | PDB-212-4/0-3..... | 260 |
| PBTS-12-4..... | 215 | PDB-11-350-2..... | 261 | PDB-212-500-1..... | 260 |
| PBTS-12-250..... | 216 | PDB-11-350-3..... | 261 | PDB-212-500-2..... | 260 |
| PBTS-12-350..... | 216 | PDB-11-500-1..... | 261 | PDB-212-500-3..... | 260 |
| PBTS-12-500..... | 217 | PDB-11-500-2..... | 261 | PDB-412-500-1..... | 264 |
| PBTS-12-750..... | 217 | PDB-11-500-3..... | 261 | PDB-428-500-1..... | 264 |
| PBTS-13-1/0..... | 215 | PDB-14-500-1..... | 259 | PDBU-26-750-1..... | 254 |
| PBTS-13-3/0..... | 215 | PDB-14-500-2..... | 259 | PDBU-49-500-1..... | 256 |
| PBTS-13-4..... | 215 | PDB-14-500-3..... | 259 | PDBU-55-500-1..... | 256 |
| PBTS-13-250..... | 216 | PDB-16-2/0-1..... | 259 | PDBU-55-600-1..... | 255 |
| PBTS-13-350..... | 216 | PDB-16-2/0-2..... | 259 | PDBU-412-500-1..... | 256 |
| PBTS-13-500..... | 217 | PDB-16-2/0-3..... | 259 | PDBU-428-500-1..... | 256 |
| PBTS-13-750..... | 217 | PDB-16-350-1..... | 259 | PDC-11-2/0-1..... | 258 |
| PBTS-14-1/0..... | 215 | PDB-16-350-2..... | 259 | PDC-14-2/0-1..... | 258 |
| PBTS-14-3/0..... | 215 | PDB-16-350-3..... | 259 | PDE-11-3/0*..... | 247 |
| PBTS-14-4..... | 215 | PDB-16-500-1..... | 260 | PDE-11-3/0-CU*..... | 247 |
| PBTS-14-250..... | 216 | PDB-16-500-2..... | 260 | PDE-14-3/0*..... | 247 |
| PBTS-14-350..... | 216 | PDB-16-500-3..... | 260 | PDE-14-3/0-CU*..... | 247 |
| PBTS-14-500..... | 217 | PDB-22-2/0-1..... | 261 | PDE-18-400‡..... | 247 |
| PBTS-14-750..... | 217 | PDB-22-2/0-2..... | 261 | PDE-22-250‡..... | 247 |
| PBTT-3-350-F..... | 224 | PDB-22-2/0-3..... | 261 | PDE-22-250-CU‡..... | 247 |
| PBTT-3-500-F..... | 224 | PDB-22-350-1..... | 261 | PDH-11-2/0-1..... | 245 |
| PBTT-3-750-F..... | 224 | PDB-22-350-2..... | 261 | PDH-11-2/0-2..... | 245 |
| PBTT-4-350-F..... | 224 | PDB-22-350-3..... | 261 | PDH-11-2/0-3..... | 245 |
| PBTT-4-500-F..... | 224 | PDB-22-500-1..... | 261 | PDH-11-2/0-A‡..... | 245 |
| PBTT-4-750-F..... | 224 | PDB-22-500-2..... | 261 | PDH-11-600-1..... | 245 |
| PBTX-4-350-F..... | 226 | PDB-22-500-3..... | 261 | PDH-11-600-2..... | 245 |
| PBTX-4-500-F..... | 226 | PDB-24-500-1..... | 260 | PDH-11-600-3..... | 245 |
| PBTX-4-750-F..... | 226 | PDB-24-500-2..... | 260 | PDH-12-350-1..... | 245 |
| PCT-2-2/0..... | 239 | PDB-24-500-3..... | 260 | PDH-12-350-2..... | 245 |
| PCT-2-4/0..... | 239 | PDB-26-2/0-1..... | 259 | PDH-12-350-3..... | 245 |

Alpha Numeric Index

| CATALOG NO. | PAGE NO. | CATALOG NO. | PAGE NO. | CATALOG NO. | PAGE NO. |
|----------------|----------|-----------------|----------|----------------|----------|
| PDH-14-2/0-1 | 245 | PDL-16-2/0-3 | 248 | PDM-112-S4-3 | 252 |
| PDH-14-2/0-2 | 245 | PDL-16-400-3 | 248 | PDMN-11-2A-1 | 251 |
| PDH-14-2/0-3 | 245 | PDL-19A-600-3 | 248 | PDMN-11-2A-2 | 251 |
| PDH-14-2/0-A† | 245 | PDL-112-600-3 | 248 | PDMN-11-2A-3 | 251 |
| PDH-14-400-1 | 245 | PDM-11-2/0B-1 | 251 | PDMN-11-2A-4 | 251 |
| PDH-14-400-2 | 245 | PDM-11-2/0B-2 | 251 | PDS-11-CC-1 | 250 |
| PDH-14-400-3 | 245 | PDM-11-2/0B-3 | 251 | PDS-11-CC-2 | 250 |
| PDH-14A-500-1 | 245 | PDM-11-2/0B-A* | 251 | PDS-11-CC-3 | 250 |
| PDH-14A-500-2 | 245 | PDM-11-2/0F-1 | 251 | PDS-11-CC-A | 250 |
| PDH-14A-500-3 | 245 | PDM-11-2/0F-2 | 251 | PDS-11-HH-1 | 249 |
| PDH-18-600-1 | 246 | PDM-11-2/0F-3 | 251 | PDS-11-HH-2 | 249 |
| PDH-18-600-2 | 246 | PDM-11-2/0T-1† | 251 | PDS-11-HH-3 | 249 |
| PDH-18-600-3 | 246 | PDM-11-2/0T-2† | 251 | PDS-11-KE-1† | 249 |
| PDH-19A-600-1 | 246 | PDM-11-2/0T-3† | 251 | PDS-11-KE-2† | 249 |
| PDH-19A-600-2 | 246 | PDM-11-2/0T-A†* | 251 | PDS-11-KE-3† | 249 |
| PDH-19A-600-3 | 246 | PDM-11-350J-1 | 251 | PDS-11-KK-1* | 250 |
| PDH-22-250-1 | 246 | PDM-11-350J-2 | 251 | PDS-11-KK-2* | 250 |
| PDH-22-250-2 | 246 | PDM-11-350J-3 | 251 | PDS-11-KK-3* | 250 |
| PDH-22-250-3 | 246 | PDM-11-350M-1 | 252 | PDS-11-PP-1 | 249 |
| PDH-22-350-1* | 246 | PDM-11-350M-2 | 252 | PDS-11-PP-2 | 249 |
| PDH-22-350-2* | 246 | PDM-11-350M-3 | 252 | PDS-11-PP-3 | 249 |
| PDH-22-350-3* | 246 | PDM-11-350S-1 | 252 | PDS-11-RR-1 | 249 |
| PDH-22-500-1* | 246 | PDM-11-350S-2 | 252 | PDS-11-RR-2 | 249 |
| PDH-22-500-2* | 246 | PDM-11-350S-3 | 252 | PDS-11-RR-3 | 249 |
| PDH-22-500-3* | 246 | PDM-11-500N-1 | 251 | PDS-11-SS-1* | 250 |
| PDH-26-2/0-1 | 245 | PDM-11-500N-2 | 251 | PDS-11-SS-2* | 250 |
| PDH-26-2/0-2 | 245 | PDM-11-500N-3 | 251 | PDS-11-SS-3* | 250 |
| PDH-26-2/0-3 | 245 | PDM-12-500D-1 | 251 | PDS-11-UU-1 | 250 |
| PDH-28-250-1 | 246 | PDM-12-500D-2 | 251 | PDS-11-UU-2 | 250 |
| PDH-28-250-2 | 246 | PDM-12-500D-3 | 251 | PDS-11-UU-3 | 250 |
| PDH-28-250-3 | 246 | PDM-14-K2/0-1 | 252 | PDS-11-UU-A+ | 250 |
| PDH-28-500-1* | 246 | PDM-14-K2/0-2 | 252 | PDS-12-PC-1 | 249 |
| PDH-28-500-2* | 246 | PDM-14-K2/0-3 | 252 | PDS-12-PC-2 | 249 |
| PDH-28-500-3* | 246 | PDM-14-S2/0-1 | 252 | PDS-12-PC-3 | 249 |
| PDH-112-600-1 | 246 | PDM-14-S2/0-2 | 252 | PDS-12-PG-1 | 249 |
| PDH-112-600-2 | 246 | PDM-14-S2/0-3 | 252 | PDS-12-PG-2 | 249 |
| PDH-112-600-3 | 246 | PDM-18-K2-1 | 252 | PDS-12-PG-3 | 249 |
| PDH-212-250-1 | 246 | PDM-18-K2-2 | 252 | PDS-12-PP-1 | 249 |
| PDH-212-250-2 | 246 | PDM-18-K2-3 | 252 | PDS-12-PP-2 | 249 |
| PDH-212-250-3 | 246 | PDM-18-S2-1 | 252 | PDS-12-PP-3 | 249 |
| PDH-212-500-1* | 246 | PDM-18-S2-2 | 252 | PED-2-2/0-Z | 172 |
| PDH-212-500-2* | 246 | PDM-18-S2-3 | 252 | PED-2-4/0-Z | 172 |
| PDH-212-500-3* | 246 | PDM-21-500Q-1 | 251 | PED2-350SS-DB | 323 |
| PDHN-11-2-1* | 245 | PDM-21-500Q-2 | 251 | PED-2-350-Z | 172 |
| PDHN-11-2-2* | 245 | PDM-21-500Q-3 | 251 | PED-2-600-Z | 172 |
| PDHN-11-2-3* | 245 | PDM-22-500N-1 | 251 | PED3-350SS-DB | 323 |
| PDHN-11-2-4* | 245 | PDM-22-500N-2 | 251 | PED3-500SS-DB | 323 |
| PDHN-14-2-1* | 245 | PDM-22-500N-3 | 251 | PED-3-500-SS-Z | 324 |
| PDHN-14-2-2* | 245 | PDM-112-K4-1 | 252 | PED-4-2/0-Z | 172 |
| PDHN-14-2-3* | 245 | PDM-112-K4-2 | 252 | PED-4-4/0-Z | 172 |
| PDHN-14-2-4* | 245 | PDM-112-K4-3 | 252 | PED4-350SS-DB | 323 |
| PDL-11-2/0-3 | 248 | PDM-112-S4-1 | 252 | PED-4-350-X | 173 |
| PDL-14-2/0-3 | 248 | PDM-112-S4-2 | 252 | PED-4-350-Z | 172 |

Alpha Numeric Index

| CATALOG NO. | PAGE NO. | CATALOG NO. | PAGE NO. | CATALOG NO. | PAGE NO. |
|---------------------|----------|-------------------------|----------|--------------------|----------|
| PED4-500SS-DB..... | 323 | PICS-68..... | 70 | RE-050-Y3WX-C..... | 423 |
| PED-4-500-SS-Z..... | 324 | PICS-70..... | 70 | RLT-8TN..... | 273 |
| PED-4-500-X..... | 173 | PICS-71..... | 70 | RLT-8TN*..... | 272 |
| PED-4-600-Z..... | 172 | PICS-72..... | 70 | RLT-8TN*..... | 331 |
| PED-4-750-SS-Z..... | 324 | PICS-73..... | 70 | RLT-9TN..... | 273 |
| PED5-350SS-DB..... | 323 | PICS-75..... | 70 | RLT-9TN*..... | 272 |
| PED5-500SS-DB..... | 323 | PICS-76..... | 70 | RLT-9TN*..... | 331 |
| PED-5-500-SS-Z..... | 324 | PICS-77..... | 70 | RLT-10..... | 272 |
| PED-6-2/0-Z..... | 172 | PICS-78..... | 70 | RLT-10..... | 273 |
| PED-6-4/0-Z..... | 172 | PICS-834..... | 71 | RLT-10..... | 331 |
| PED6-350SS-DB..... | 323 | PICS-835..... | 71 | RLT-12..... | 272 |
| PED-6-350-X..... | 173 | PICS-836..... | 71 | RLT-12..... | 273 |
| PED-6-350-Z..... | 172 | PICS-844..... | 71 | RLT-12..... | 331 |
| PED6-500SS-DB..... | 323 | PICS-845..... | 71 | SAS-70..... | 187 |
| PED-6-500-SS-Z..... | 324 | PICS-846..... | 71 | SAU-70..... | 187 |
| PED-6-500-X..... | 173 | PICS-847..... | 71 | SBC-14..... | 313 |
| PED-6-600-Z..... | 172 | PICS-854..... | 71 | SBC-38..... | 313 |
| PED-6-750-SS-Z..... | 324 | PICS-855..... | 71 | SBC-516..... | 313 |
| PED-8-2/0-Z..... | 172 | PICS-856..... | 71 | SBJ-X-6..... | 314 |
| PED-8-4/0-Z..... | 172 | PICS-857..... | 71 | SBJ-X-9..... | 314 |
| PED8-350SS-DB..... | 323 | PICS-858..... | 71 | SBJ-X-12..... | 314 |
| PED-8-350-X..... | 173 | PICS-864..... | 71 | SBJ-X-15..... | 314 |
| PED-8-350-Z..... | 172 | PICS-865..... | 71 | SBJ-X-18..... | 314 |
| PED8-500SS-DB..... | 323 | PICS-866..... | 71 | SBJ-X-21..... | 314 |
| PED-8-500-SS-Z..... | 324 | PICS-867..... | 71 | SBJ-X-24..... | 314 |
| PED-8-500-X..... | 173 | PICS-868..... | 71 | SBJ-X-28..... | 314 |
| PED-8-600-Z..... | 172 | PICS-869..... | 71 | SBJ-X-32..... | 314 |
| PED-8-750-SS-Z..... | 324 | PISTOLGRIP-CASE-L..... | 374 | SBJ-X-36..... | 314 |
| PED9-350SS-DB..... | 323 | PISTOLGRIP-CASE-XL..... | 374 | SBJ-X-40..... | 314 |
| PED10-350SS-DB..... | 323 | PSA-4-750-Z..... | 173 | SBJ-X-44..... | 314 |
| PET-4-350-Z..... | 174 | PSA-6-750-Z..... | 173 | SBJ-X-48..... | 314 |
| PET-4-500-Z..... | 174 | PSA-8-750-Z..... | 173 | SBJ-X-54..... | 314 |
| PET-4-750-Z..... | 174 | PTA2-500-500-w/c..... | 164 | SBJ-X-60..... | 314 |
| PET-6-350-Z..... | 174 | PTA2-750-500-w/c..... | 164 | SBJ-X-66..... | 314 |
| PET-6-500-Z..... | 174 | PTA4-750-500-w/c..... | 164 | SBJ-X-72..... | 314 |
| PET-6-750-Z..... | 174 | PTA26-500-4/0*+..... | 164 | SBJ-X-712..... | 314 |
| PET-8-350-Z..... | 174 | PTT-2L-0-Z..... | 175 | SBJ-X-1012..... | 314 |
| PET-8-500-Z..... | 174 | PTT-2L-250-Z..... | 175 | SBW-14..... | 312 |
| PET-8-750-Z..... | 174 | PTT-2L-350-Z..... | 175 | SBW-38..... | 312 |
| PG402-2S-Z..... | 185 | PTT-2R-0-Z..... | 175 | SBW-516..... | 312 |
| PG402-S-Z..... | 185 | PTT-2R-250-Z..... | 175 | SC1..... | 418 |
| PG620-2A-Z..... | 185 | PTT-2R-350-Z..... | 175 | SC1-CTUV50..... | 418 |
| PG620-2S-Z..... | 185 | QCA-F..... | 374 | SC2..... | 418 |
| PG620-S-Z..... | 185 | QCA-M..... | 374 | SC2-CTUV50..... | 418 |
| PG620-Z..... | 185 | R-16..... | 206 | SC3..... | 418 |
| PG810-S-Z..... | 185 | R-16..... | 284 | SC3-CTUV50..... | 418 |
| PICS-61..... | 70 | R-16..... | 412 | SC4..... | 418 |
| PICS-62..... | 70 | RCPMP-5..... | 374 | SC4-CTUV50..... | 418 |
| PICS-63..... | 70 | RE-050-1P1X-AΔ..... | 423 | SC5..... | 418 |
| PICS-64..... | 70 | RE-050-1P1X-CΔ..... | 423 | SC5-CTUV50..... | 418 |
| PICS-65..... | 70 | RE-050-1R1X-AΔ..... | 423 | SC6..... | 418 |
| PICS-66..... | 70 | RE-050-1R1X-CΔ..... | 423 | SC6-CTUV50..... | 418 |
| PICS-67..... | 70 | RE-050-Y3WX-A..... | 423 | SC7..... | 418 |

Alpha Numeric Index

| CATALOG NO. | PAGE NO. | CATALOG NO. | PAGE NO. | CATALOG NO. | PAGE NO. |
|------------------------------|---------------|---------------|----------|---------------|----------|
| SC7-CTUV50..... | 418 | SGB-4+..... | 285 | SLUH-400..... | 189 |
| SC8..... | 418 | SGB-5+..... | 167 | SLUH-650..... | 189 |
| SC8-CTUV50..... | 418 | SGB-5+..... | 285 | SPA-0..... | 156 |
| SC15..... | 418 | SGB-250..... | 167 | SPA-2..... | 156 |
| SCNL-27..... | 181 | SGB-250..... | 285 | SPA-250..... | 156 |
| SCNL-27..... | 310 | SHST..... | 374 | SPA-350..... | 156 |
| SCNM-18..... | 182 | SK-1/0..... | 131 | SPA-500..... | 156 |
| SCNM-18..... | 311 | SK-1/0..... | 207 | SPA-750..... | 156 |
| SCNM-21..... | 182 | SK-2 +..... | 131 | SPA-1000..... | 156 |
| SCNM-21..... | 311 | SK-2 +..... | 207 | SPAR-1/0..... | 240 |
| SCNM-24..... | 182 | SK-2/0..... | 131 | SPAR-2..... | 240 |
| SCNM-24..... | 311 | SK-2/0..... | 207 | SPAR-4..... | 240 |
| SCNM-27..... | 182 | SK-3 +..... | 131 | SPAR-250..... | 240 |
| SCNM-27..... | 311 | SK-3 +..... | 207 | SPAR-350..... | 240 |
| SCNM-30..... | 182 | SK-3/0..... | 131 | SPAR-500..... | 240 |
| SCNM-30..... | 311 | SK-3/0..... | 207 | SPDL-0..... | 278 |
| SCNM-33..... | 182 | SK-4 +..... | 131 | SPDL-0..... | 336 |
| SCNM-33..... | 311 | SK-4 +..... | 207 | SPDL-1..... | 278 |
| SCNM-36..... | 182 | SK-6 +..... | 131 | SPDL-1..... | 336 |
| SCNM-36..... | 311 | SK-6 +..... | 207 | SPDL-2..... | 278 |
| SCNM-39..... | 182 | SK-8..... | 131 | SPDL-2..... | 336 |
| SCNM-39..... | 311 | SK-8..... | 207 | SPDL-3..... | 278 |
| SCNM-42..... | 182 | SK-10..... | 131 | SPDL-3..... | 336 |
| SCNM-42..... | 311 | SK-10..... | 207 | SPDL-4..... | 278 |
| SE-050-1S1X-*..... | 424 | SK-250..... | 131 | SPDL-4..... | 336 |
| SE-050-1S1X-*..... | 425 | SK-250..... | 207 | SPDL-5..... | 278 |
| SE-050-3N4X-*..... | 424 | SK-350..... | 131 | SPDL-5..... | 336 |
| SE-050-3N4X-*..... | 425 | SK-350..... | 207 | SPDL-6..... | 278 |
| SE-050-3Y1X-*..... | 424 | SK-500..... | 131 | SPDL-6..... | 336 |
| SE-050-3Y1X-*..... | 425 | SK-500..... | 207 | SPDL-8..... | 278 |
| SE-050-3Y2X-*..... | 424 | SK-750..... | 131 | SPDL-8..... | 336 |
| SE-050-3Y2X-*..... | 425 | SK-750..... | 207 | SPDL-9..... | 278 |
| SE-100-1S1X-*..... | 424 | SK-1000..... | 131 | SPDL-9..... | 336 |
| SE-100-1S1X-*..... | 425 | SK-1000..... | 207 | SPDL-10..... | 278 |
| SE-100-3N4X-*..... | 424 | SLS-35..... | 187 | SPDL-10..... | 336 |
| SE-100-3N4X-*..... | 425 | SLS-70..... | 187 | SPDS-0..... | 277 |
| SE-100-3Y1X-*..... | 424 | SLS-300..... | 187 | SPDS-0..... | 335 |
| SE-100-3Y1X-*..... | 425 | SLS-400..... | 187 | SPDS-1..... | 277 |
| SE-100-3Y2X-*..... | 424 | SLS-650..... | 187 | SPDS-1..... | 335 |
| SE-100-3Y2X-*..... | 425 | SLU-35..... | 187 | SPDS-2..... | 277 |
| SEC-2W..... | 418 | SLU-35DB..... | 187 | SPDS-2..... | 335 |
| * Series: 2ACL, 2ACN..... | thru 750kcmil | SLU-35DB..... | 330 | SPDS-3..... | 277 |
| 363 | | SLU-70..... | 187 | SPDS-3..... | 335 |
| Series: ACL, ACN | | SLU-70DB..... | 187 | SPDS-4..... | 277 |
| thru 750kcmi..... | 363 | SLU-70DB..... | 330 | SPDS-4..... | 335 |
| Series: ALNS, ALND..... | 363 | SLU-300..... | 187 | SPDS-5..... | 277 |
| Series: ALNS, ALND, ASN..... | 381 | SLU-400..... | 187 | SPDS-5..... | 335 |
| Series: *ASN, AS..... | 363 | SLU-650..... | 187 | SPDS-6..... | 277 |
| Series: IACL, 2IACL | | SLUH-35..... | 189 | SPDS-6..... | 335 |
| thru 750kcmil..... | 363 | SLUH-90..... | 189 | SPDS-8..... | 277 |
| SGB-1/0..... | 167 | SLUH-125..... | 189 | SPDS-8..... | 335 |
| SGB-1/0..... | 285 | SLUH-225..... | 189 | SPDS-10..... | 277 |
| SGB-4+..... | 167 | SLUH-300..... | 189 | SPDS-10..... | 335 |

Alpha Numeric Index

| CATALOG NO. | PAGE NO. | CATALOG NO. | PAGE NO. | CATALOG NO. | PAGE NO. |
|-------------|----------|------------------|----------|------------------|----------|
| SPSL-0 | 276 | SSKC-4-Z | 322 | T4A4-250N* | 150 |
| SPSL-0 | 334 | SSKC-6-Z | 184 | T4A4-350N* | 150 |
| SPSL-1 | 276 | SSKC-6-Z | 322 | T4A4-600N* | 150 |
| SPSL-1 | 334 | SSKC-250-Z | 184 | T4A4-800N* | 150 |
| SPSL-2 | 276 | SSKC-250-Z | 322 | T4A4-1000N* | 150 |
| SPSL-2 | 334 | Stacking Adaptor | 309 | TA-0‡ | 145 |
| SPSL-3 | 276 | STL11-1/OSS6 | 325 | TA-2‡ | 145 |
| SPSL-3 | 334 | STL11-1/OSS6 | 326 | TA-2/0‡ | 145 |
| SPSL-4 | 276 | STL11-1/OSS6 | 327 | TA3/OI-TC | 143 |
| SPSL-4 | 334 | STL11-1/OSS8 | 325 | TA-6-S‡ | 145 |
| SPSL-5 | 276 | STL11-1/OSS8 | 326 | TA-250‡ | 145 |
| SPSL-5 | 334 | STL11-1/OSS10 | 325 | TA250I-TC | 143 |
| SPSL-6 | 276 | STL11-1/OSS10 | 326 | TA-300‡ | 145 |
| SPSL-6 | 334 | STL12-1/OSS6 | 325 | TA-350‡ | 145 |
| SPSL-8 | 276 | STL12-1/OSS6 | 326 | TA-350-2N | 145 |
| SPSL-8 | 334 | STL12-1/OSS6 | 327 | TA-350-2NS | 145 |
| SPSL-10 | 276 | STL12-1/OSS8 | 325 | TA350I-TC | 143 |
| SPSL-10 | 334 | STL12-1/OSS8 | 326 | TA-500‡ | 145 |
| SPSS-0 | 275 | STL12-1/OSS10 | 325 | TA500I-TC | 143 |
| SPSS-0 | 333 | STL12-1/OSS10 | 326 | TA-500-S | 145 |
| SPSS-1 | 275 | STL21-1/OSS6 | 325 | TA-600 | 145 |
| SPSS-1 | 333 | STL21-1/OSS6 | 326 | TA-600-2N | 145 |
| SPSS-2 | 275 | STL21-1/OSS6 | 327 | TA-600-2NS | 145 |
| SPSS-2 | 333 | STL21-1/OSS8 | 325 | TA-800 | 145 |
| SPSS-3 | 275 | STL21-1/OSS8 | 326 | TA-800-2N | 145 |
| SPSS-3 | 333 | STL21-1/OSS10 | 325 | TA-800-2NS | 145 |
| SPSS-4 | 275 | STL21-1/OSS10 | 326 | TA800I-TC | 143 |
| SPSS-4 | 333 | STL22-1/OSS6 | 325 | TA-800-S | 145 |
| SPSS-5 | 275 | STL22-1/OSS6 | 326 | TA-1000 | 145 |
| SPSS-5 | 333 | STL22-1/OSS8 | 325 | TA-1000-2N | 145 |
| SPSS-6 | 275 | STL22-1/OSS8 | 326 | TA-1000-2NS | 145 |
| SPSS-6 | 333 | STL22-1/OSS10 | 325 | TA-1000-S | 145 |
| SPSS-8 | 275 | STL22-1/OSS10 | 326 | TB-6DF1000-P | 350 |
| SPSS-8 | 333 | STL22-1/OSS10 | 327 | TB-6DF1000-PX | 350 |
| SPSS-9 | 275 | SX-6+ | 196 | TB-6WBG500-I | 348 |
| SPSS-9 | 333 | SX-10-8 | 196 | TB-6WBG500-IX | 348 |
| SPSS-10 | 275 | SX-12 | 196 | TB-6WD3500-I | 348 |
| SPSS-10 | 333 | T3A2-0 | 149 | TB-6WD3500-IX | 348 |
| SS-350-Z | 184 | T3A2-2 | 149 | TB-6WO500-I | 348 |
| SS-350-Z | 322 | T3A2-3/0N | 149 | TB-6WO500-IX | 348 |
| SSK-350-Z | 184 | T3A2-250N | 149 | TB-12U1000-P | 351 |
| SSK-350-Z | 322 | T3A2-350N | 149 | TB-12U1000-PX | 351 |
| SSKC-1/0-Z | 184 | T3A2-600N* | 149 | TB-CUT25HD-I | 359 |
| SSKC-1/0-Z | 322 | T3A2-800N* | 149 | TB-CUT25HD-IX | 359 |
| SSKC-2/0-Z | 184 | T3A2-1000N* | 149 | TB-CUT25-P | 352 |
| SSKC-2/0-Z | 322 | T3A4-0 | 149 | TB-CUT25-PX | 352 |
| SSKC-2-Z | 184 | T3A4-2 | 149 | TB-CUT26ACSR-IS | 361 |
| SSKC-2-Z | 322 | T3A4-3/0N | 149 | TB-CUT26ACSR-ISX | 361 |
| SSKC-3/0-Z | 184 | T3A4-250N | 149 | TB-CUT40CU-IS | 360 |
| SSKC-3/0-Z | 322 | T3A4-350N | 149 | TB-CUT40CU-ISX | 360 |
| SSKC-4/0-Z | 184 | T3A4-600N* | 149 | TB-CUT45-P | 353 |
| SSKC-4/0-Z | 322 | T3A4-800N* | 149 | TB-CUT45-PX | 353 |
| SSKC-4-Z | 184 | T3A4-1000N* | 149 | TB-CUT50CU-P | 354 |

Alpha Numeric Index

| CATALOG NO. | PAGE NO. | CATALOG NO. | PAGE NO. | CATALOG NO. | PAGE NO. |
|-----------------------|----------|----------------------|----------|------------------------|----------|
| TB-CUT50CU-PX | 354 | TTGC3TN* | 279 | USPA21-1/0SS-DB | 321 |
| TB-CUT65CU-PS | 356 | TTGC3TN* | 337 | USPA21-1/0SS-DB* | 183 |
| TB-CUT65CU-PSX | 356 | TTGC4+ | 279 | USPA21-1/0SS-DB* | 320 |
| TB-CUT85CU-P | 355 | TTGC4+ | 337 | USPA22-1/0SS-DB | 321 |
| TB-CUT85CU-PX | 355 | TTGC4TN* | 279 | USPA22-1/0SS-DB* | 183 |
| TB-CUT95CU-PS | 357 | TTGC4TN* | 337 | USPA22-1/0SS-DB* | 320 |
| TB-CUT95CU-PSX | 357 | TW-1 | 398 | USPA-350SS-DB+ | 183 |
| TB-CUT120CU-PS | 358 | TW-150R | 398 | USPA-350SS-DB+ | 320 |
| TB-CUT120CU-PSX | 358 | TW-750R | 398 | USPA-500SS-DB | 183 |
| TB-PMP-PRO | 372 | UCS-1/0-Z | 69 | USPA-500SS-DB | 320 |
| TB-PMP-PROX | 372 | UCS-2/0-Z | 69 | USPA-750SS-DB | 183 |
| THT-K | 388 | UCS-2-Z | 69 | USPA-750SS-DB | 320 |
| T-JAWBG | 348 | UCS-3/0-Z | 69 | U-W-BAG | 374 |
| T-JAWD3 | 348 | UCS-4/0-Z | 69 | VBFT-10-195-P25 | 120 |
| T-JAWO | 348 | UCS-4-Z | 69 | VBFT-14-156-P50 | 120 |
| TK-1 | 398 | UCS-250-Z | 69 | VBFT-18-156-P50 | 120 |
| TK-2 | 398 | UCS-300-Z | 69 | VBMT-10-195-P25 | 120 |
| TLK-1 | 154 | UCS-350-Z | 69 | VBMT-14-156-P50 | 120 |
| TLK-2 | 154 | UCS-500-Z | 69 | VBMT-18-156-P50 | 120 |
| TLK-3 | 154 | UCS-600-Z | 69 | VBSS-10-P25 | 124 |
| TLK-4 | 154 | UCS-700/750-Z | 69 | VBSS-14-P50 | 124 |
| TM-6DF1000 | 362 | UCS-1000-Z | 69 | VBSS-18-P50 | 124 |
| TM-12U1000 | 363 | UDe-Ox-V-40Z*+ | 414 | VBST-10-P25 | 124 |
| TM-CUT25 | 364 | UDe-Ox-V-80Z*+ | 414 | VBST-14-P50 | 124 |
| TM-CUT45 | 364 | USB | 374 | VBST-18-P50 | 124 |
| TM-CUT50CU | 365 | USGL-350R21 | 155 | VDFT-10-250-P25 | 116 |
| TM-CUT85CU | 365 | USGL-350R42 | 155 | VDFT-14-110-P50 | 116 |
| TMFT-PMP | 373 | USGL-350R43 | 155 | VDFT-14-187-P50 | 116 |
| TR-6DF1000 | 366 | USGL-350R64 | 155 | VDFT-14-250-P50 | 116 |
| TR-12U1000 | 367 | USGL-350R86 | 155 | VDFT-18-110-P50 | 116 |
| TRC-CUT32ACSR | 396 | USGL-350R128 | 155 | VDFT-18-187-P50 | 116 |
| TRC-CUT750CU | 396 | USGL-600R21 | 155 | VDFT-18-250-P50 | 116 |
| TR-CUT25 | 368 | USGL-600R42 | 155 | VDMT-10-250-P25 | 117 |
| TR-CUT45 | 368 | USGL-600R63 | 155 | VDMT-14-187-P50 | 117 |
| TR-CUT50CU | 369 | USGL-600R84 | 155 | VDMT-14-250-P50 | 117 |
| TR-CUT65CUS | 370 | USGL-600R106 | 155 | VDMT-18-110-P50 | 117 |
| TR-CUT85CU | 369 | USGL-600R148 | 155 | VDMT-18-187-P50 | 117 |
| TR-CUT95CUS | 370 | USGL-750R21 | 155 | VDMT-18-250-P50 | 117 |
| TR-CUT120CUS | 370 | USGL-750R42 | 155 | VFBR-10-14-P25 | 114 |
| TS-35 | 398 | USGL-750R63 | 155 | VFBR-14-14-P50 | 114 |
| TST-CBS52 | 393 | USGL-750R84 | 155 | VFBR-18-14-P50 | 114 |
| TST-CC60 | 395 | USGL-750R126 | 155 | VFIBT-10-195-P25 | 120 |
| TST-CJ54 | 391 | USGL-750R148 | 155 | VFIBT-14-156-P50 | 120 |
| TST-CNS41 | 394 | USGL-1000R21 | 155 | VFIBT-18-156-P50 | 120 |
| TST-CP52 | 392 | USGL-1000R22 | 155 | VFIDT-10-250-P25 | 118 |
| TST-UJ25 | 389 | USGL-1000R42 | 155 | VFIDT-18-187-P50 | 118 |
| TST-UJ45 | 390 | USGL-1000R63 | 155 | VPBR-10-551-P25 | 121 |
| TTGC2 | 279 | USGL-1000R84 | 155 | VPBR-14-512-P50 | 121 |
| TTGC2 | 337 | USGL-1000R126 | 155 | VPBR-18-512-P50 | 121 |
| TTGC2TN+ | 279 | USGL-1000R168 | 155 | VRBR-10-6MS-P25 | 99 |
| TTGC2TN+ | 337 | USPA-1/0SS-DB | 321 | VRBR-10-6-P25 | 94 |
| TTGC3 | 279 | USPA-1/0SS-DB* | 183 | VRBR-10-8-P25 | 94 |
| TTGC3 | 337 | USPA-1/0SS-DB* | 320 | VRBR-10-10-P25 | 94 |

Alpha Numeric Index

| CATALOG NO. | PAGE NO. | CATALOG NO. | PAGE NO. | CATALOG NO. | PAGE NO. |
|-----------------|----------|---------------|----------|---------------|----------|
| VRBR-10-12-P25 | 94 | WM-13-W-09 | 420 | XE-050-1P2X-* | 427 |
| VRBR-10-14-P25 | 94 | WM-13-W-AJ | 420 | XE-050-1S1X-* | 426 |
| VRBR-10-38-P25 | 94 | WM-13-W-KT | 420 | XE-050-1S1X-* | 427 |
| VRBR-10-516-P25 | 94 | WM-13-W-UZ | 420 | XE-050-3D1X-* | 426 |
| VRBR-14-6MS-P50 | 99 | WM-023-N-09 | 420 | XE-050-3D1X-* | 427 |
| VRBR-14-6-P50 | 94 | WM-023-W-09 | 420 | XE-050-3N4X-* | 426 |
| VRBR-14-8-P50 | 94 | WM-023-W-AJ | 420 | XE-050-3N4X-* | 427 |
| VRBR-14-10-P50 | 94 | WM-023-W-KT | 420 | XE-050-3N6X-* | 426 |
| VRBR-14-12-P25 | 94 | WM-023-W-UZ | 420 | XE-050-3Y1X-* | 426 |
| VRBR-14-14-P50 | 94 | WM-103-N-09 | 420 | XE-050-3Y1X-* | 427 |
| VRBR-14-38-P25 | 94 | WM-103-W-09 | 420 | XE-050-3Y2X-* | 426 |
| VRBR-14-516-P50 | 94 | WM-103-W-AJ | 420 | XE-050-3Y2X-* | 427 |
| VRBR-18-4-P50 | 94 | WM-103-W-KT | 420 | XE-050-3Y3X-* | 426 |
| VRBR-18-6MS-P50 | 99 | WM-103-W-UZ | 420 | XE-100-1P1X-* | 426 |
| VRBR-18-6-P50 | 94 | WM-203-W-09 | 420 | XE-100-1P1X-* | 427 |
| VRBR-18-8-P50 | 94 | WM-203-W-AJ | 420 | XE-100-1P2X-* | 426 |
| VRBR-18-10-P50 | 94 | WM-203-W-KT | 420 | XE-100-1P2X-* | 427 |
| VRBR-18-14-P50 | 94 | WM-203-W-UZ | 420 | XE-100-1S1X-* | 426 |
| VRBR-18-38-P25 | 94 | WM-B02-NW | 422 | XE-100-1S1X-* | 427 |
| VRBR-18-516-P50 | 94 | WM-B02-W | 422 | XE-100-3D1X-* | 426 |
| VSBR-10-6-P25 | 101 | WM-B-10-045 | 419 | XE-100-3D1X-* | 427 |
| VSBR-10-8-P25 | 101 | WM-B-10-4690 | 419 | XE-100-3N4X-* | 426 |
| VSBR-10-10-P25 | 101 | WM-B-10-AZ | 419 | XE-100-3N4X-* | 427 |
| VSBR-10-14-P25 | 101 | WM-B10-NW | 422 | XE-100-3N6X-* | 426 |
| VSBR-10-516-P25 | 101 | WM-B10-W | 422 | XE-100-3Y1X-* | 426 |
| VSBR-14-6-P50 | 101 | WM-B-15-130 | 419 | XE-100-3Y1X-* | 427 |
| VSBR-14-8-P50 | 101 | WM-B-15-AZ | 419 | XE-100-3Y2X-* | 426 |
| VSBR-14-10-P50 | 101 | WM-B-30-B | 419 | XE-100-3Y2X-* | 427 |
| VSBR-14-14-P50 | 101 | WM-B-40-09 | 419 | XE-100-3Y3X-* | 426 |
| VSBR-18-4-P50 | 101 | WM-B-45-09 | 419 | XT-0 | 192 |
| VSBR-18-6-P50 | 101 | WM-B-60-B | 419 | XT-4 | 192 |
| VSBR-18-8-P50 | 101 | WM-B-150-ABC | 419 | XT-4DB | 192 |
| VSBR-18-10-P50 | 101 | WM-CA02-N-09 | 421 | XT-4DB | 330 |
| VSBR-18-14-P50 | 101 | WM-CA02-W-09 | 421 | XT-6 ‡ | 192 |
| VSFBR-10-6-P25 | 110 | WM-CA02-W-AJ | 421 | XT-6DB | 192 |
| VSFBR-10-8-P25 | 110 | WM-CA02-W-KT | 421 | XT-6DB | 330 |
| VSFBR-10-10-P25 | 110 | WM-CA02-W-UZ | 421 | XT-10 | 192 |
| VSFBR-14-6-P50 | 110 | WM-CA10-N-09 | 421 | XT-40 | 192 |
| VSFBR-14-8-P50 | 110 | WM-CA10-W-09 | 421 | XT-500*+ | 192 |
| VSFBR-14-10-P50 | 110 | WM-CA10-W-AJ | 421 | | |
| VSFBR-18-6-P50 | 110 | WM-CA10-W-KT | 421 | | |
| VSFBR-18-8-P50 | 110 | WM-CA10-W-UZ | 421 | | |
| VSFBR-18-10-P50 | 110 | WM-T02-M | 421 | | |
| VSLBR-10-6-P25 | 106 | WM-T10-M | 421 | | |
| VSLBR-10-8-P25 | 106 | WR-1 | 398 | | |
| VSLBR-10-10-P25 | 106 | WR-1A | 398 | | |
| VSLBR-10-14-P25 | 106 | WR-4 | 398 | | |
| VSLBR-14-6-P50 | 106 | WR-9 | 398 | | |
| VSLBR-14-10-P50 | 106 | WR-10 | 398 | | |
| VSLBR-18-6-P50 | 106 | WR-12 | 398 | | |
| VT-4-S | 191 | XE-050-1P1X-* | 426 | | |
| WC | 398 | XE-050-1P1X-* | 427 | | |
| WM-13-N-09 | 420 | XE-050-1P2X-* | 426 | | |

nVent.com



USA

Tel 513.533.6200



Our powerful portfolio of brands:

CADDY ERICO HOFFMAN ILSCO RAYCHEM SCHROFF