



CONNECT AND PROTECT

Rail Solutions

Expertly Engineered. Global Capabilities

nvent

ERICO



Table of Contents

• Introduction

- The Global Railway Industry 3
- A Global Solutions Partner for the Railway Industry 3

• Products & Solutions

- nVent ERICO Cadweld and nVent ERICO Cadweld Plus Rail Connections 4
- Cadweld and Cadweld Plus Bonding Products 6
- nVent ERICO Bonding Products 8
- nVent ERICO Railway Conductors 10
- nVent ERICO Railclips 12
- Lightning and Surge Protection for Railway Facilities 13
- nVent ERICO Direct Strike Lightning Protection Systems 14
- nVent ERICO Grounding and Bonding 15
- Surge Protection Devices for Rail Applications 16
- Tools, Systems and Machines for Railway Applications 19
- Rail Switch Heating Systems 21

• Worldwide Market Competence

- Local to you 22

INTRODUCTION

nVent is a leading global manufacturer and marketer of superior engineered products for niche electrical, mechanical and concrete applications.

These nVent products are sold globally under a variety of market-leading brands: nVent ERICO Cadweld electrical connections, facility electrical protection, and rail and industrial products; nVent CADDY fixing, fastening and support products; nVent ERIFLEX low-voltage power and grounding connections; and nVent LENTON engineered systems for concrete reinforcement.

For more information on nVent ERICO, CADDY, ERIFLEX and LENTON, please visit nVent.com/ERICO.

Introduction

As a partner for the global railway industry, nVent ERICO is established as one of the best. With manufacturing, development and distribution networks in North America, Latin America, Europe and Asia, we provide worldwide competence while guaranteeing proximity to our customers and optimal satisfaction of local market demands.

nVent ERICO strives to meet the individual requirements of our customers through high-quality and innovative design, production, development and implementation. For complete product information, including technical drawings, features and benefits, product certifications, images, videos and more, visit: nVent.com/ERICO.

THE GLOBAL RAILWAY INDUSTRY

Railroads are the backbone of most countries, and play a key role in the ability to compete in markets around the world, hauling exports to ports and other intranational distribution centers. The resilience of most countries depends on a multi-modal transportation system that efficiently links businesses with consumers, suppliers, markets and the global economy.

A GLOBAL SOLUTIONS PARTNER FOR THE RAILWAY INDUSTRY

nVent ERICO is the worldwide leader in connecting cables to rails for signaling, grounding and traction power requirements. From signal circuits, to traction power leads, to grounding, nVent ERICO offers the widest range of products and solutions to meet the demanding requirements of the global railway industry.

nVent ERICO recognizes the importance of the evolving railway industry. Our active involvement ensures we will continue to design, develop and enhance our product offerings to meet the changing needs of the railway industry. All nVent ERICO Brand products and solutions are manufactured in accordance with ISO 9000 series accreditation and are backed by superior technical support and product warranties.

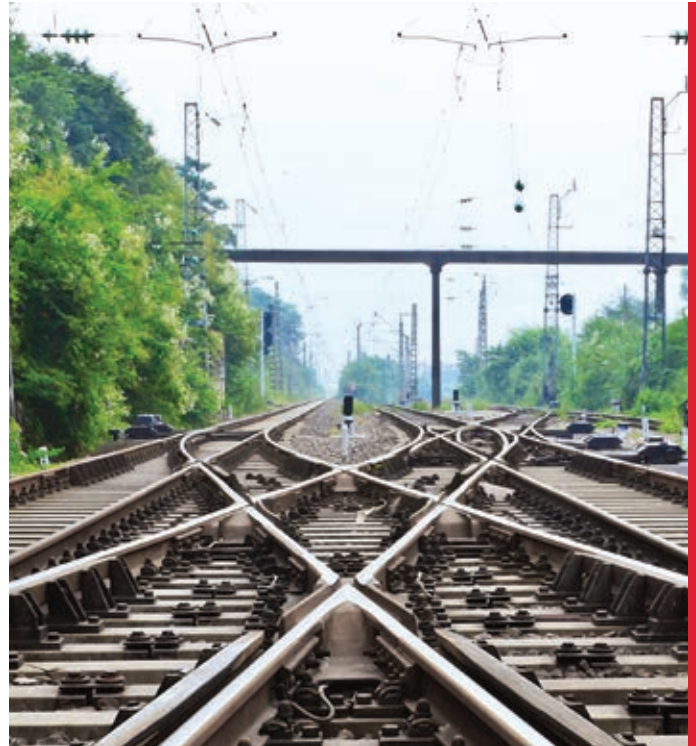

Our international growth is a result of being more than just a product manufacturer. Today nVent ERICO offers the global rail industry a diversified corporation with a network of sales locations serving more than 25 countries, and with manufacturing and distribution facilities worldwide.

nVent ERICO is acknowledged as the premier electrical connection provider in the railway industry due to our extensive experience, strong relationships with end users and continued investment in research and development. nVent ERICO provides unrivalled service, innovative solutions and local expertise to the rail industry.



Products & Solutions

CADWELD AND CADWELD PLUS RAIL CONNECTIONS



CADWELD & CADWELLS PLUS RAIL CONNECTIONS

Cadweld provides an efficient field method for any electrical connection, from signal and traction power to grounding. Cadweld bonds offer maximum protection against physical damage, superior shear strength, maximum corrosion resistance and maintains a low resistance for the life of the installation. nVent ERICO provides railhead joint and rail web-signal, power and grounding bonds and unique connections.

Cadweld Plus offers a simplified method for exothermic connections to rail. The features of Cadweld Plus include tamper proof, integrated patented weld material alloy packaging and a CE/UL battery powered electronic ignition source. All connections to the head of the rail shall be within the confines of the joint bars and on the field side of the railhead. All other connections to rail shall be made on the rail web at the neutral axis.

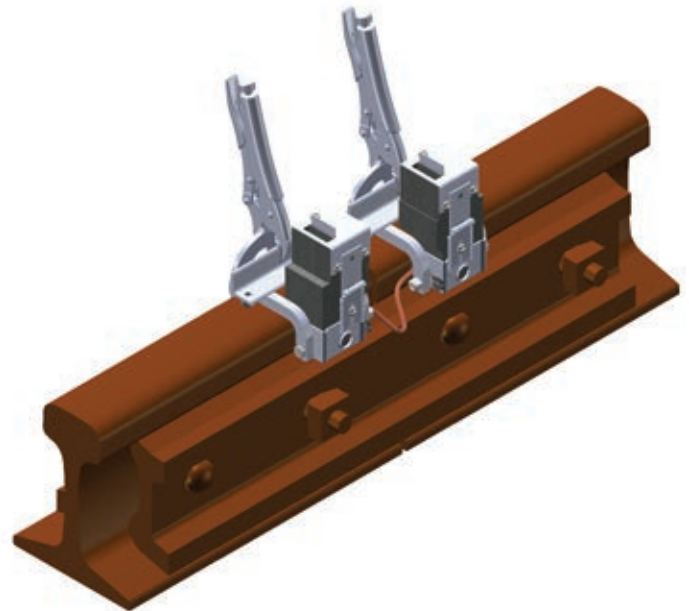

CADWELD RAIL SIGNAL BONDS

Cadweld signal bonds provide broken rail detection within the joint bar and detect the presence of trains or obstructions automatically contributing to the safest possible signal system.

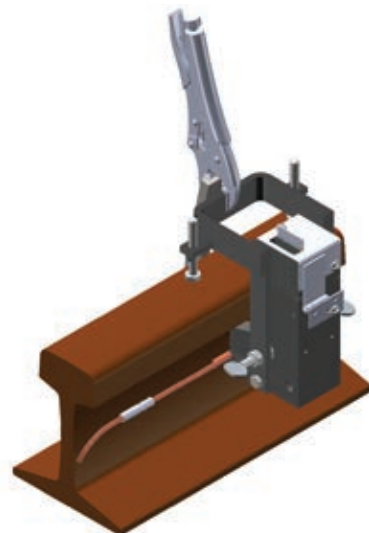

Products & Solutions

CADWELD AND CADWELD PLUS RAIL CONNECTIONS



RAILHEAD JOINT BONDS

Cadweld railhead joint bonds are the industry standard for joint bonding. They provide maximum broken rail detection rail within the joint bars, low electrical resistance, maximum corrosion resistance and maximum protection against physical damage contributing to the safest possible system. The bonds meet or exceed recommendations and design criteria described in the American Railway Engineering and Maintenance-of-Way Association (AREMA) Manual Part 8.1.30.



TRACK CONNECTORS

Cadweld track connectors utilize preformed terminals. They provide a convenient means of connecting cables outside the confines of the joint bar including special track work. Located at the neutral axis, where the connection is least susceptible to fatigue and is also kept clear of dragging equipment as well as track maintenance equipment. The connectors meet or exceed recommendations and design criteria described in AREMA Manual Part 8.1.32.



THREADED STUD-TO-RAIL CONNECTIONS

Cadweld threaded stud-to-rail connections provide a permanent and convenient bonding point for connecting cables to rails and special track work sections. This is particularly desirable when a cable disconnect is required and when drilling a hole in the rail is not possible or undesirable. Examples would be large casting sections of frogs and switches or grooved rail where only one side of the rail can be exposed for bonding purposes. A great solution for signaling track circuits or bonding the track to ground/earth.



JUMPER, SWITCH AND BOOTLEG BONDS

Cadweld prefabricated bond kits incorporate formed terminals on a flexible length of bond strand cable. Bonds are factory made in various lengths and configurations – thus eliminating a typically cumbersome field fabrication. These bonds are often offered in kits with the necessary weld material for attachment to rail.



FIELD MADE BONDS

These highly durable tab-style terminals provide low electrical resistance and superior corrosion resistance. Cadweld installation equipment is user friendly and highly portable allowing for minimal installer training. The product is equally adjustable on old, worn and/or new rails.

Products & Solutions

CADWELD AND CADWELD PLUS BONDING PRODUCTS



POWER BONDS

The Cadweld process affords a simple, portable means for making welded electrical connections to rail and electrical conductors of many types. The integrity of the Cadweld process provides a molecular bond that cannot loosen or corrode, thus providing a maintenance-free electrical connection.

Cadweld power bonds are available in kits (including bonds, replacement molds and weld material) or as bonds only for applications including: power feeders to contact rail, negative return leads and impedance bond leads. Power bond conductors are typically larger than 2/0 AWG (70 mm²) up to and including 500kcmil (240mm²). Also included in the Cadweld power bond offering are contact rail joints, contact rail feed cable attachments, welded cable lugs, welded cable joints, shunts and impedance bond center leads.



RAILHEAD JOINT BONDS

Cadweld railhead joint bonds are the industry standard for rail joint bonding. They provide the necessary current carrying capacity, contributing to a safe and reliable system. The bonds meet or exceed recommendations and design criteria described in AREMA Manual Part 8.1.31.



Products & Solutions

CADWELD AND CADWELD PLUS BONDING PRODUCTS



WEB BONDS

Cadweld rail web connections utilize preformed terminals. They provide a convenient means of connecting conductors outside the confines of the joint bar including special track work. Located at the neutral axis, the connection is least susceptible to fatigue and also is kept clear of dragging equipment as well as track maintenance equipment. The bonds meet or exceed recommendations and design criteria described in AREMA Manual Part 8.1.33.

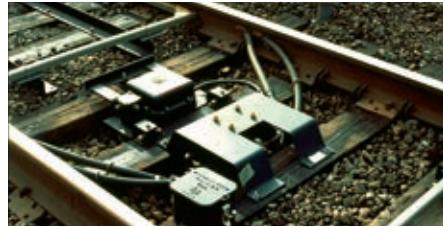

IMPEDANCE BOND LEADS

Cadweld prefabricated impedance bond center tap leads incorporate formed terminals on a flexible laminated conductor or a conductor length that includes Cadweld tinned copper lugs. Leads are factory made to system specifications and impedance bond type for installation ease – thus eliminating a typically cumbersome field fabrication. These features and benefits are also available for prefabricated side tap leads.



CONTACT RAIL POWER FEEDS

nVent ERICO provides connections for any conductor size to traditional steel or composite contact rails and offers Cadweld lug sets when disconnection is desirable. Prefabricated power feed assemblies with Cadweld tinned copper lugs are compatible with aluminum contact rails as well as all other types.



CONTACT RAIL SPLICE

nVent ERICO is the premier supplier of welded joints for steel contact rails and can produce virtually any contact rail weld regardless of size, shape or orientation. When welds are made in tunnels the Cadweld Exolon low smoke emission process is ideal.

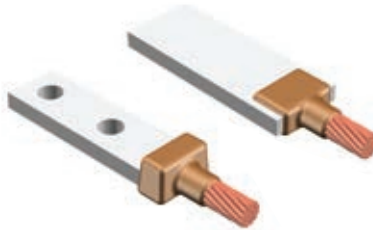

CABLE-TO-LUG CONNECTIONS

Cadweld provides an efficient field method for any electrical connection. Unlimited design and manufacturing capabilities allow nVent ERICO to make it possible to provide the best weld for any connection requirement. Virtually any sized conductor can be attached to the proper corresponding tinned copper lug in a wide range of configurations as well as bolt patterns.

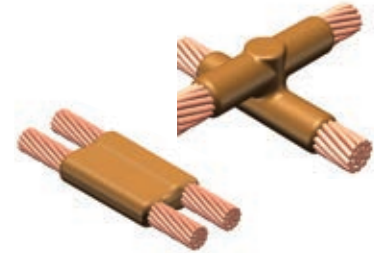

CABLE-TO-CABLE CONNECTIONS

The Cadweld process provides an efficient field method for any electrical connection. Unlimited design and manufacturing capabilities allow nVent ERICO to make it possible to provide the best weld for any connection requirement. Virtually any sized conductor can be spliced to the same size, differing sizes or multiple cable arrays. Many connections are UL Listed and meet or exceed IEEE 837 recommendations.

THREADED STUD-TO-RAIL CONNECTIONS

Cadweld threaded stud-to-rail connections provide a permanent and convenient bonding point for connecting conductors to rails and special track work sections. This is particularly desirable when a conductor disconnect is required and when drilling a hole in the rail is not possible or is undesirable. Examples would be large casting sections of frogs and switches or grooved trolley rail where only one side of the rail can be exposed for bonding purposes. A great solution for signaling track circuits or bonding the track to ground.



Products & Solutions

NVENT ERICO BONDING PRODUCTS



NVENT ERICO BONDS

nVent ERICO is the world leader in providing bonds and electrical connections for rail systems. A wide range of connections is offered to meet specific requirements dictated by application or market preference. Those options include a variety of mechanical connectors as well as arc-welded bonds and temporary connections suitable for signaling, grounding and power applications.

Single and dual shunts are designed for use by railway personnel responsible for the operation, inspection, and maintenance of rail equipment. The easy-to-carry assembly can be used on most common rail types. The product is engineered and tested to provide permanent 0.06 ohm shunting. Orange insulation ensures high visibility for safety and the T-shaped handle allows quick and easy tightening by hand.



NVENT ERICO ERICONTACT

Ericontact series of rail contacts provides a superior quality connection to the rail web with a very low contact resistance. The mechanical rail contact system is used for signaling, earthing and traction current return applications. The contacts are quickly and easily installed with an insertion tool. A range of hydraulic insertion tools complements the product offering. Ericontact products meet or exceed recommendations and design criteria described in AREMA Manual Parts 8.1.35 and 8.1.36. Meets recommendations of SNCF, ADIF, REFER, Jernbaneverket and DB for rail connections.

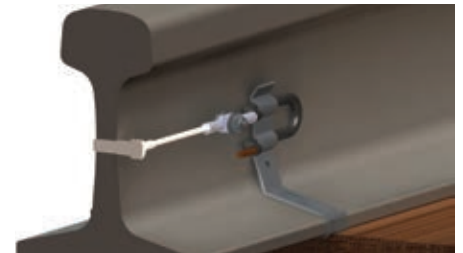

TAPERED PINS (CHICKEN HEADS)

Complementing our line of bonding options, nVent ERICO manufactures numerous types of mechanical bonds including factory-made plug bonds for joint bonding, track circuit connections and special track work bonding. Tapered pins are welded to the conductors for superior electrical and mechanical properties. nVent ERICO steel tapered pin rail connections are designed to be installed in a 3/8" (9.5mm) hole drilled in the rail web at the neutral axis. Bonds are available in either single stranded or duplex stranded conductors. Conductors can be selected from bronze bondstrand, composite steel and bronze bondstrand, composite steel and copper or copper coated steel. These bonds meet or exceed recommendations and design criteria described in AREMA Manual Part 8.1.25.

ARC-WELDED BONDS

nVent ERICO arc-welded bonds are available today for use in mass transit applications, contact rail connections and in mining operations. They are used in applications where arc-welding equipment and trained operators are available.



Products & Solutions

NVENT ERICO BONDING PRODUCTS



CROWN SOCKETS

nVent ERICO offers tinned-bronze forged crown socket-type stud terminals for attachment to round conductors. Factory made assemblies or components for field made assemblies are available. These terminals are easily attached to cables from 350≈kcmil (150mm²) up to and including 500 kcmil (240mm²) using the Cadweld process. Crown socket bonds can be used on all types of exposed track bonding applications including: traction power negative returns, impedance bond side leads, cross bonds and special track work bonding. Bonds can be constructed in any length. nVent ERICO crown sockets connections are designed to be installed in a 1" (25.4mm) size hole drilled in the rail web at the neutral axis. Crown sockets are furnished with a steel tapered pin and fastening hardware.

TEMPORARY BOND CONNECTORS

Temporary Bond Connectors can be used on most common rail types and make temporary signal bonds and track circuit connections using customer-supplied cable. This type of rail bond is used as a temporary or stationary connection of cables to the rail. It can also be used as a temporary connection between two tracks while rails are being changed. Hardened contact points on clamps bite through rust and scale. The single conductor connection (solid or stranded) provides a unique design that guarantees positive contact and firm grip.



Products & Solutions

NVENT ERICO RAILWAY CONDUCTORS



BONDSTRAND

Bondstrand allows mechanical or compressed types of connections as well as Cadweld welded connections. It is highly flexible and resistant to vibration fatigue. Insulation is manufactured from 600 volt-rated PVC. Two insulation thicknesses are available including: 4/64" (0.063", 1.6 mm) and 6/64" (0.094", 2.4 mm). nVent ERICO Bondstrand meets or exceeds recommendations and design criteria described in AREMA Manual Parts 8.1.20, 8.1.25, 8.1.30, 8.1.32 and 10.3.12.



BRAID

Flat Bare and Insulated Braided Conductors are the ideal ready-to-install, flexible cable replacement solution. Flat Insulated Braided Conductors features integral pre-punched palms that are ready to connect out of the box. There are no lugs to purchase or install, making connections simpler and faster and eliminating faulty connections due to vibration or fatigue. The insulation on our insulated braid types is a high-resistance self-extinguishing PVC.



NVENT ERICO CU-BOND COMPOSITE CABLES

Cu-Bond Composite Cables are theft-deterrent conductors. They are designed to carry a specific load and function as copper conductors, but appear to be non-copper conductors. They have little to no scrap value and are difficult to cut or steal. These conductors are ideal for exposed electrical distribution grounding leads where copper theft may occur.



Products & Solutions

NVENT ERICO RAILWAY CONDUCTORS

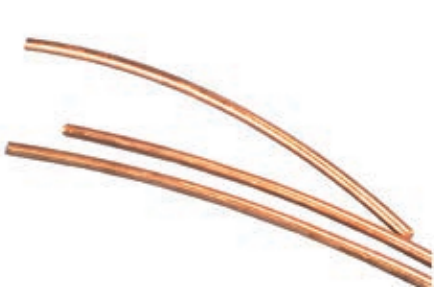

CU-BOND ROUND CONDUCTORS

Cu-Bond round conductors are composed of an electro-plated coating of copper deposited over a steel core. The multi-layer electro-plating process helps ensure a long-lasting, molecular bond between the copper layer and the steel core. The copper-bonded coating will not crack or tear when the conductor is bent. The conductor core consists of a low-carbon steel grade for improved flexibility in the field. The copper surface of the conductor provides conductivity and corrosion resistance properties.

Due to their steel core, Cu-Bond round conductors are theft-deterrent. They are also magnetic, notifying potential thieves that the materials within are of little scrap value. Cu-Bond Round Conductors can be used in both above-grade and below-grade applications. Their unique properties make them ideal for either horizontal or vertical placement.



NVENT ERIFLEX FLEXIBAR

Flexibar is a flexible busbar cable replacement solution for low voltage applications. It is formed from multiple layers of thin electrolytic copper insulated with a high-resistance, self-extinguishing PVC or silicone compound.

Easily formed even in its largest size, Flexibar vastly improves design and assembly flexibility and the aesthetic of finished panels. All Flexibar cross sections can be bent, folded, or twisted with a small bending radius for shorter and more compact power connections.

Flexibar connections are made by punching and bolting directly through the copper laminates, clamping onto the end of the Flexibar, or welding using Cadweld. There are no lugs to purchase or install, making the installation simpler and faster.



THEFT-DETERRENT COMPOSITE CABLE

Theft-deterrent composite cables are conductors that function as copper conductors, but appear to be non-copper conductors and are difficult to cut or steal. These conductors are ideal for exposed electrical leads where copper theft may occur. Theft-deterrent conductors are difficult to cut with hand tools and the outer steel stranding is magnetic, which further deters thieves looking to steal copper. Theft-deterrent composite cables are either bare or insulated concentric stranded conductors that consist of outer galvanized steel strands that protect and conceal internal tinned copper strands.



Products & Solutions

RAILCLIPS



RAILCLIPS

Railclips offer a versatile range of conductor management solutions that are designed to increase the useful lifetime of trackside conductors and reduce the total project cost over time. The range provides a wide assortment of clips and accessories for all typical conductors runs that reduce maintenance and improve wayside safety.

Railclips are available for many applications including: switch heating systems attachment on either fixed or movable rails, attachment for various types of presence-detection loops, termination shunts, as well as track connections for signaling or power applications.

Railclips feature either stainless steel construction or a multi-layer proprietary coating over spring steel that provides optimal corrosion protection. Our global presence allows us to design solutions with the needs of each customer in mind, ensuring that we will have a track clip system that will meet the needs of railroads and transit groups in all countries and accommodating nearly every rail profile produced in the world. The clips offered by nVent ERICO include: Hammer-On, Snap-on and Wrap-Around Clips for Rail as well as Snap-On and Glued Clips for Concrete Ties.

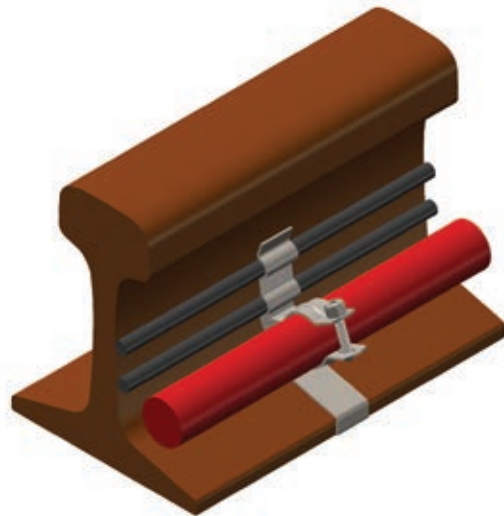

Products & Solutions

LIGHTNING AND SURGE PROTECTION FOR RAILWAY FACILITIES

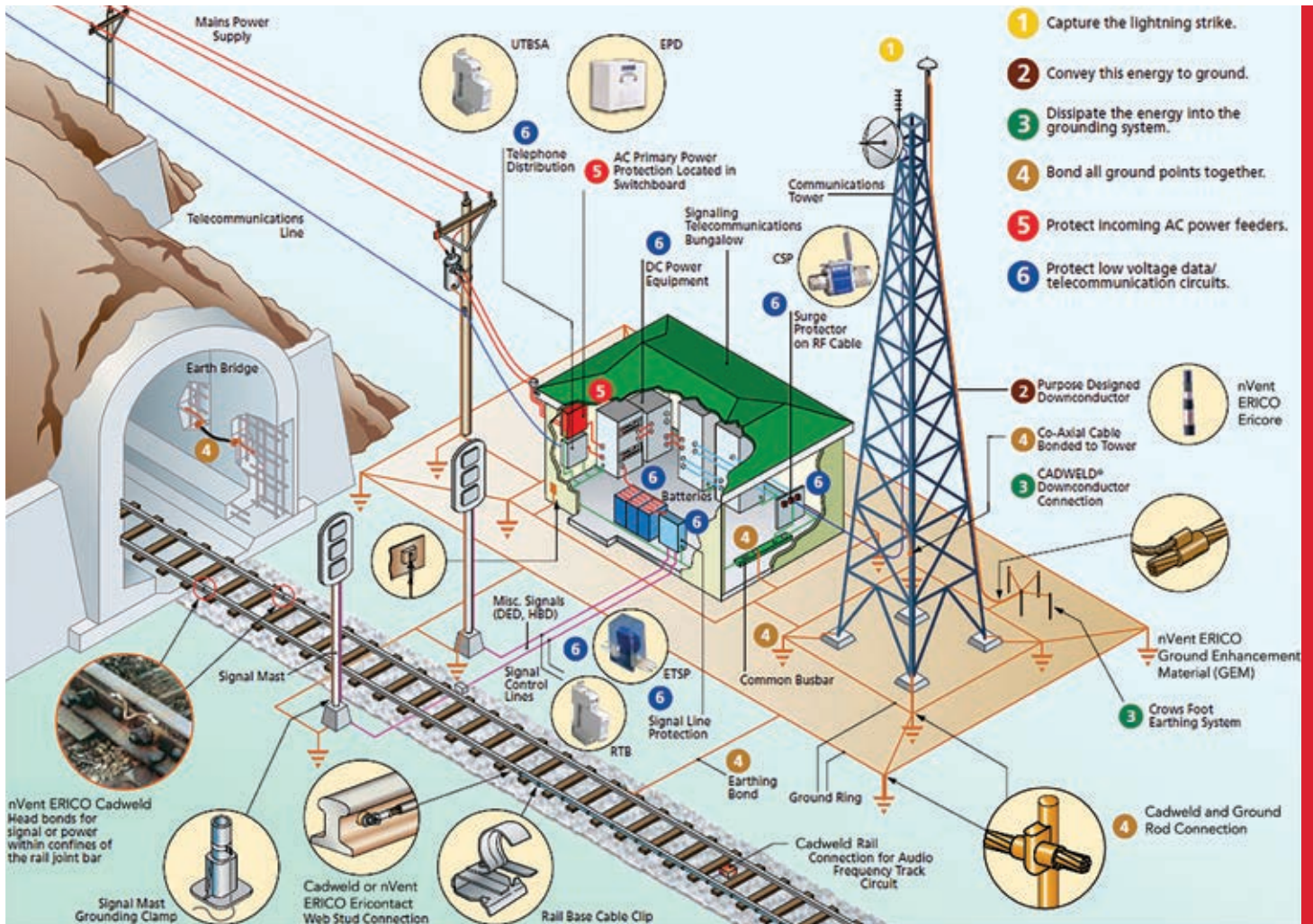

LIGHTNING AND SURGE PROTECTION FOR RAILWAY FACILITIES

Modern electronics and circuitry used in signaling, computing, communications and defect-detection installations are highly susceptible to damage from lightning surges and other transient over-voltages.

The consequences of an unexpected lightning strike or power surge can be catastrophic for a railway facility including the safety risk to personnel, damage to critical equipment, data corruption and the costs associated with operational downtime. As the railway industry becomes more dependent on increasingly sensitive equipment, proper protection from lightning and dangerous over-voltage transients is necessary.

The Six Point Protection Plan from nVent ERICO (which is above) helps help minimize the risk of damage to facilities through:

- Direct Strike Protection
- Grounding and Bonding
- Surge and Over-Voltage Transient Protection



Products & Solutions

NVENT ERICO DIRECT STRIKE LIGHTNING PROTECTION SYSTEMS



Direct Strike Lightning Protection Systems

nVent ERICO provides three systems for capturing lightning energy. As a global solution provider nVent ERICO supports the global market with products and expertise suitable for the challenges and specific requirements for each market to provide guidance and optimal lightning protection solutions. Some structures are more suited to the traditional conventional lightning protection – designs that require protection via complete building structure bonding. Other structures are more suited to an alternative method. Whatever the application or protection problem presented, nVent ERICO offers a solution.



SYSTEM 1000

Designed and tested to NFC, 17-102, the air terminals are constructed from 304 stainless steel and designed to be suitable for most environments. A variety of down conductor systems, including tape, cable, smooth-weave, isolated down conductor (ISODC) and nVent ERICO Ericore conductor.



SYSTEM 2000

System 2000 series of air terminals, down-conductors and fittings are in accordance with national and international standards such as Australian-AS1768, Singaporean-CP33, IEC/EN 62305-3 and USA-NFPA 780. System 2000 offers a wide range of air terminals, mounting bases, cable connectors and fasteners. The air termination components and fittings are available in copper and aluminum. Down conductors are available as stranded or flat-tape construction.

SYSTEM 3000

nVent ERICO is dedicated to providing the best lightning protection solution for any given application, whether this involves the use of the standards compliant System 2000, System 3000 or a hybrid design utilizing a combination of both system types. nVent ERICO has developed System 3000 advanced lightning protection system. This innovative system has been used in over 15,000 installations, including some of the most vulnerable buildings in the world around the world. nVent ERICO aims to provide the best solution for any given application.



Products & Solutions

NVENT ERICO GROUNDING AND BONDING



Grounding & Bonding

nVent ERICO offers an extensive line of grounding and bonding products for the railway industry including: ground rods and accessories, Cadweld exothermic connections, earth bridges, chemical ground rods, Ground Enhancement Material (GEM), couplers, clamps, inspection wells, grounding and perimeter bus bars, equipotential mesh and mats, and ground test instruments.

Ground/Earth Electrodes

nVent ERICO is the leading manufacturer of UL listed copper-bonded ground rods. Our offering includes a complete range of rods, driving sleeves and studs, rod coupling methods and connections for reliable grounding in nearly every railway or transit application.



STRUCTURE BONDING | SAFETY AND CORROSION CONTROL

nVent ERICO manufactures prefabricated earthing bonds to customized specifications. These bonds can be made from various types and sizes of conductors. Cadweld makes a corrosion free, permanently welded assembly that is the best solution for connections inside concrete structures. The property of low electrical resistance is important for earthing and cathodic protection of reinforcing bars and steel beams in bridges, guide ways, slab track, station platforms and tunnels. An equipotential bond between all current carrying elements in a structure and earth is required for personnel safety in case of catenary failure. A cathodic protection system prevents damage to steel work due to corrosion and reduces expensive maintenance.

nVent ERICO also designs and manufactures specific solutions for the proper grounding of aluminum structures; signal masts and bridges, wayside cabinets and houses, and grade crossing structures.



GROUND ENHANCEMENT MATERIAL (GEM)

GEM is a superior permanent conductive material that solves the toughest grounding problems. It is the ideal maintenance free material to use in areas of poor conductivity, such as rocky ground, mountain tops and sandy soil. GEM is also the answer in situations where ground rods can't be driven or where limited land area makes adequate grounding difficult with conventional methods. Exceeds IEC 62561-7 which sets the benchmark for corrosion, leaching, sulfur content, and other environmental regulations. Complies with the United States Environmental Protection Agency (EPA) Toxicity Characteristic Leaching Procedure (TCLP), EPA test method 1311.

Products & Solutions

SURGE PROTECTION DEVICES FOR RAIL APPLICATIONS



PROTECTION DEVICES FOR POWER APPLICATIONS

Lightning transients and surges are a major cause of expensive electronic equipment failure and downtime for global railways. The EPD family of power surge protection devices offer economical and reliable protection from power transients with the convenience of easy installation. EPD's are expressly designed for the unique electrical, mechanical, and environmental requirements of the railway sector.



PRIMARY POWER PROTECTION

Protection Devices for primary AC power are hybrid Transient Voltage Surge Suppression (TVSS) filter devices that also incorporate Transient Discriminating (TD) technology. Devices comply with ANSI/IEEE C62.41.2-2002 Cat A, Cat B, Cat C; ANSI/IEEE C62.41.2-2002 Scenario II, Exposure 2, 50 kA 8/20 μ s; AREMA recommendations.

SECONDARY POWER PROTECTION

Protection Devices for AC and DC secondary power are hybrid Transient Voltage Surge Suppression (TVSS) technology. All provide low let-through voltage and provide sine wave filtering for RFI/EMI attenuation.

Products & Solutions

SURGE PROTECTION DEVICES FOR RAIL APPLICATIONS



SURGE PROTECTION DEVICES FOR ELECTRONIC TRACK SIGNAL

nVent ERICO specializes in both primary and secondary surge protection products for sophisticated railway signaling infrastructure, providing proven solutions that increase safety and reliability on track. nVent ERICO Electronic Track Signal Protection is also available as a DIN rail mounted device. The EPDM protection module includes all the features of the EPD-F and conveniently mounts onto the nVent ERICO EPD100P terminal block. Exceeds the AREMA recommendations for lightning arrester applications.

NVENT ERICO RTBN NEXT GENERATION

For many years railroads have relied on nVent ERICO Rail Transient Barrier (RTB) products for protection against damaging voltage surges and transient events. With this well-established product line, and industry-leading expertise, nVent ERICO has introduced RTBN, the next generation in surge protection devices. RTBN builds on the successful legacy of the nVent ERICO RTB products while adding features and functionality to meet the needs of modern railroads. With a maximum surge rating of 40kA 8/20 (nominal surge rating is 20kA), RTBN continues to provide industry-leading performance and reliability that end-users have come to expect. RTBN's DIN rail grounding connection eliminates the need for additional wires. Its new design is compact, with latching surge module that minimizes issued issues caused by vibration and human error. Other added features include a thermal disconnect for safe failure, visual status indicators, and remote monitoring, all of which are now standard predictive maintenance functionalities.



NVENT ERICO TRACK CIRCUIT PROTECTION DEVICES

Track Circuit Protection Devices provide transient protection from surges induced or conducted onto low-voltage signal circuits for trackside signaling equipment. The series of surge-protection devices are ideal for protecting DC-responsive track relays, train-detection systems, microprocessor-based train-control and indication circuits, train inspection systems, communications systems, highway crossing controls and other operationally sensitive systems. All devices exceed the AREMA recommendations for both arrester and equalizer applications.

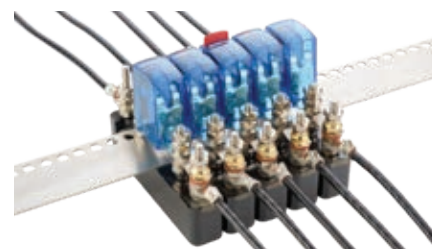

ELECTRONIC TRACK SIGNAL PROTECTION DEVICES WITH FLAG

nVent ERICO EPD F-Series Electronic Track Signal Protection devices with flag status indication help ensure that the surges do not pose a safety threat in the event of component failure. Tactile flag indicator on the devices serve a dual purpose: they help safeguard the devices against shorting to ground and provide status indication by touch or visual inspection. The EPD-F is designed to be employed on AAR-style terminal blocks. Exceeds the AREMA recommendations for both arrester and equalizer applications.



Products & Solutions

SURGE PROTECTION DEVICES FOR RAIL APPLICATIONS

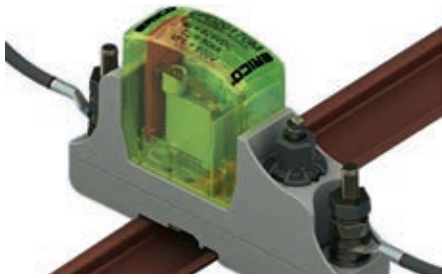

DIN RAIL MOUNTED ELECTRONIC TRACK SIGNAL PROTECTION DEVICE

Electronic Track Signal Protection is also available as a DIN rail mounted device. The EPD protection device includes all the features of the EPD-F and incorporates the EPD100P terminal block. Features include direct mounting to ground plane, reduction in field wiring time, integrated circuit test link, proven AAR terminal connections all-in-one convenient and solution driven package. Exceeds the AREMA recommendations for lightning arrester applications.



FOUR POST TERMINAL BLOCK

The Four Post Terminal Block provides important features necessary for the successful protection of electronic signaling equipment from lightning damage. The patented design offers the separation of arrester input and output wiring to eliminate the inductive coupling of lightning currents. Also included is an integrated external cable test terminal that allows for testing without disassembly of the arrester mounting hardware. The design allows the arrester to be mounted directly onto a low impedance surge plane thus providing nearly zero lead length to earth. Accepts all standard AAR hardware and meets AREMA recommendations.



NVENT ERICO PROTECTION PANEL / LOW IMPEDANCE SURGE PLANE

The Protection Panel acknowledges the importance of good grounding, electrical bonding and properly applied surge protection. When all of these facets work together, they provide the best possible electronic environment and improves the performance of all surge-arresting devices.

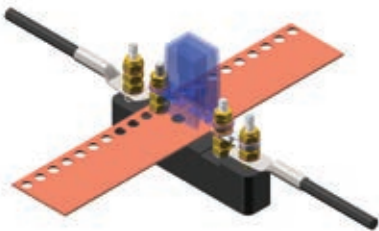

SURGE PLANE GROUND BUS

The Protection Panel incorporates a wide, flat copper bus to form a grid for lower impedance to the ground reference point. The grid effect provides a more attractive electrical path for surge currents. It enables all arresters to have the same impedance to ground thus reducing voltage differentials between lines from being a potential threat to electronic equipment.



NVENT ERICO COPPER DIN RAIL

The Copper DIN Rail allows the EPD100P terminal blocks and EPD surge arresters the same installation advantages of traditional railway mounted devices. The formation of a Low Impedance Surge Panel system improves the performance of surge protection devices and allows for proper wiring practices.

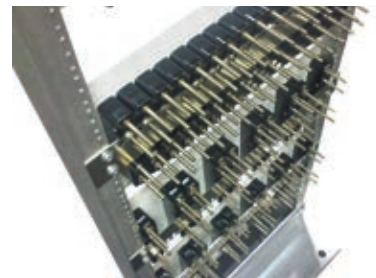

ENGINEERED PANELS

The Protection Panel is also available as a well-engineered panel. These ready-to-install panels are applicable to common installations; i.e., defect-detection locations, equipment identification locations, weight-monitoring location and communications sites. These panels are particularly convenient for field installation or where equipment footprints are limited. Panels are ready to install and can be pre-populated with necessary arrester devices and attachment points.

Products & Solutions

TOOLS, SYSTEMS AND MACHINES FOR RAILWAY APPLICATIONS



TOOLS, SYSTEMS AND MACHINES FOR RAILWAY APPLICATIONS

Originally developed as tools for the preparation of rail for bond applications, nVent ERICO has developed its range of tools to be suitable for many rail infrastructure applications and offers a variety of different construction-grade drills, grinders, tools, accessories and replacement parts for on-site field assembly. These portable and easy-to-use tools can be battery powered, AC electric powered or gasoline powered and are compatible with normal or grooved rails.

nVENT ERICO DRILLING MACHINES

Drilling Machines are designed for smooth, reliable and powerful drilling operations in rail for electrical connections, Ericcontact, Tapered Pins as well as Crown Sockets. Product range includes petrol/gasoline, both two and four cycle machines, as well as, electro-powered machines. All work with various products, from signaling bond applications to rail joint bolt hole sizes. A wide range of accessories are available, including rail clamping units, drill cutters, and rail profile templates as well as special application templates.



Products & Solutions

TOOLS, SYSTEMS AND MACHINES FOR RAILWAY APPLICATIONS

RAIL GRINDING MACHINES

Construction-grade grinding machines for production and maintenance rail bonding. Product range includes petrol/gasoline, both two and four cycle machines, as well as, battery operated portable or pedestal mounted devices. The pedestal mounted petrol/gasoline machine is available with a track dolly for greater ease of operation in a production environment.



CONDUCTOR INSULATION STRIPPING TOOL

nVent ERICO has a range of stripping tools that provide precision stripping without damaging the conductor or inner insulation when jacketed, stripping quickly even in cold climates. The guarded cutting blades ensure safety and bushings change easily with the supplied hex wrench.



RAIL SWITCH HEATING SYSTEMS

Snow and ice buildup can be hazardous and can interfere with rail infrastructure, transit equipment, operations, and service. nVent provides full engineering support and solutions for rail heating, snow melting and de-icing for a variety of transit applications providing confidence even in the harshest environments.

Self-regulating electric heat trace cables from nVent RAYCHEM automatically adjust their power output to compensate for temperature changes. Heat is generated as electric current passes through the conductive polymer core between the conductors. As the temperature drops, the number of electrical paths through the core increases and more heat is produced. Conversely, as the temperature rises, the core has fewer electrical paths and less heat is produced. Self-regulating electric heat trace cables are easy to install on any rail profile and can be cut to length, spliced or repaired on site. They require very low maintenance reducing the total cost of installation. In addition to their extreme reliability, they save on energy costs and prolong the life of the rail system.



Worldwide Market Competence

LOCAL TO YOU

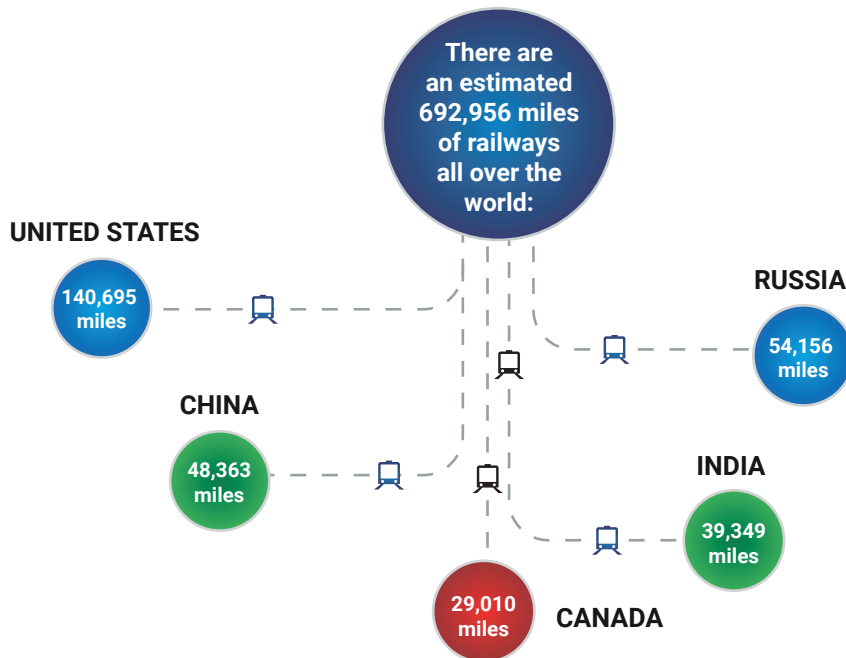

QUICK FACTS:

- Australia has the world's longest section of straight railway track that stretches nearly 297 miles across Southern Australia.
- The Indian Railway employs about 1.4 million people, making it one of the world's top 10 biggest employers.
- The average freight train is about 1 to 1¼ miles in length (90 to 120 rail cars). When moving at 55 miles per hour, it can take a mile or more to stop after the locomotive engineer fully applies the emergency brake.
- Railroads in the United States move 42% of intercity freight, more than any other mode of transportation in the country.
- ANSI is a registered trademark of American National Standards Institute.
- AREMA is a registered trademark of American Railway Engineering and Maintenance-of-Way Association, Inc.
- IEEE is a registered trademark of The Institute of Electrical and Electronics Engineers, Inc.

ACCORDING TO THE WORLDWATCH INSTITUTE*

- A draft plan for French transportation infrastructure investments for the next two decades allocates 52 percent of a total of \$236 billion to high-speed rail.
- In 2005, the Spanish government announced an ambitious plan for some 10,000 kilometers of high-speed track by 2020, which would allow 90 percent of Spaniards to live within 50 kilometers of a high-speed rail station.
- Currently, China is investing about \$100 billion annually in railway construction. The share of the country's railway infrastructure investment allocated to high-speed rail has risen from less than 10 percent in 2005 to a stunning 60 percent in 2010.
- Intercity rail in Japan accounts for 18 percent of total domestic passenger-kilometers by all travel modes-compared with just 5 to 8 percent in major European countries and less than 1 percent in the United States.
- In France, rail market share of the Paris-Marseille route rose from 22 percent in 2001 (before the introduction of high-speed service) to 69 percent in 2006. In Spain, the Madrid-Seville rail route's share rose from 33 to 84 percent.

*Worldwatch is an independent research organization based in Washington, D.C. that works on energy, resource, and environmental issues.

For more information, visit www.worldwatch.org.

North America

Tel +1.800.545.6258
rail@nvent.com

Europe, Middle East, Africa

Tel +32.16.213.511
rail@nvent.com

Asia Pacific

Tel +86.21.2412.1688
rail@nvent.com

Latin America

Tel +1.713.868.4800
rail@nvent.com

Our powerful portfolio of brands:

CADDY ERICO HOFFMAN RAYCHEM SCHROFF TRACER



[nVent.com/ERICO](https://www.nvent.com/ERICO)