

TRACETEK Leak Detection System

COMMERCIAL BUILDING APPLICATION AND PRODUCT SELECTION GUIDE

SCOPE OF THIS GUIDE

This guide will help you select TraceTek leak detection products including sensing cables and components for a variety of liquids in commercial building applications:

- Water
- Water/Glycol
- Liquid fuels and oils

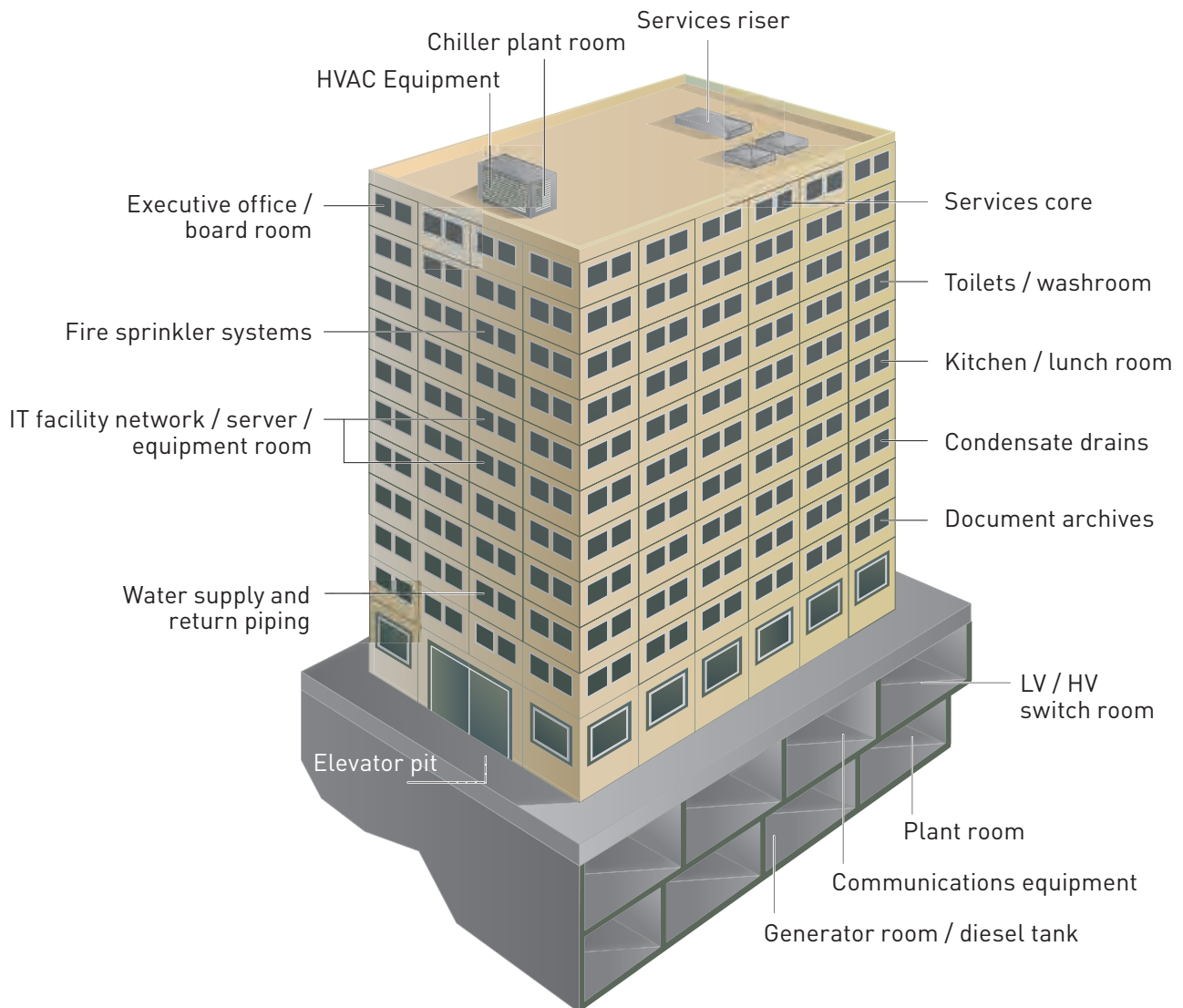

MODULAR DESIGN APPROACH

A TraceTek leak detection system reflects a versatile modular strategy that uses interchangeable components which can be configured in many different ways, making it easy to extend or modify a system for future flexibility. TraceTek sensing cables are easy to install. Standard cable lengths with factory installed connectors are available that plug together with no special tools. Bulk cable can also be provided along with corresponding connector kits to provide the capability for field installation of customized lengths of sensing cable.

The broad range of TraceTek alarm modules, sensing cables and components allows you to tailor the monitoring approach and layout to your specific application. Sophisticated designs can be constructed to monitor large areas within a commercial building, including the ability to locate leaks in hundreds of separate circuits. Simple designs can be used for small areas to provide cost effective solutions. A variety of different applications can be integrated into a building management system.

CONTENTS OF THIS GUIDE

This guide is divided into four sections.

- 1. Applications** includes descriptions and illustrations of several typical TraceTek leak detection applications.
- 2. TraceTek Leak Detection** System examples provide a basic introduction to the parts used to construct a TraceTek leak detection system.
- 3. Designing your system** discusses the design elements to be addressed as part of defining your leak detection system.
- 4. Product Listings** summarizes the range of leak detection products related to Commercial Building applications, and provides technical and ordering information.



APPLICATION DISCUSSION

There are many applications for TraceTek leak detection in Commercial Buildings:

- **Computer rooms** to locate water leaks beneath raised floors
- **Server/communication rooms** to detect water leaks above racked equipment
- **Mechanical equipment** to detect water leaks from HVAC units, pipes and fittings
- **Emergency power supply equipment** to detect fuel leaks around diesel generators and storage tanks
- **Water supply lines** to detect water leaks from suspended hot or chilled water pipelines, and the areas underneath the pipelines
- **Critical equipment** to detect water ingress into electrical pits, trenches and other important areas
- **Laboratories** to monitor areas around delicate instruments or areas exposed to accidental spillage
- **Building service columns** to locate leaks near plumbing and electrical accesses to warn about leakage to the floors below

Illustrations and discussion of several typical TraceTek leak detection applications appear on the following pages.

IMPORTANT WARNINGS AND NOTES

The following icons   are used extensively throughout this manual to alert you to important warnings that affect safety and to important notes that affect the proper operation of the unit. Be sure to read and follow them carefully.

APPLICATIONS: COMPUTER ROOM

SYSTEM DESIGN

The construction of a leak detection system for a computer room focuses on water leaks originating from various sources, including air conditioning (A/C) units, chilled water piping, plumbing and condensate lines, clogged drains, sprinkler systems, and building leaks.

ALARM MODULE

The system's alarm panel is placed on a wall that is convenient for operator access.

The TT-TS12 alarm panel and Sensor Interface Modules (TTSIM) may also be connected to BMS systems or monitored remotely.

SENSING CABLE

TT1000 sensing cable is laid around the perimeter of the room a maximum of three feet from the walls and positioned according to the requirements of the application, as follows:

- The cable is positioned so that fluid from A/C units, piping, and other equipment installed along the walls can be detected before the fluid reaches power or data cables.
- To protect large surface areas the cable is laid in a serpentine pattern.
- The cable should be placed under the center of the floor tiles so that it is easy to access quickly in the event a leak is detected.

CABLE REQUIREMENTS

- The size and specifics of the application determine the length of cable required.
- Additional cable is necessary for potential trouble areas—such as floor drains, chiller lines, condensate lines, and service piping—and to accommodate a service loop at each sensing cable connection.
- Estimated cable length is calculated on the basis of a simple formula that assumes the cable is routed in a serpentine pattern and the center-to-center spacing is within the recommended range of 6 to 10 ft:

$$\frac{\text{floor area protected (ft}^2\text{)}}{\text{center to center spacing (ft)}} = \text{cable length (ft)}$$



APPLICATIONS: COMPUTER ROOM (CONTINUED)

SYSTEM MAP

A graphic display map is mounted near the alarm module for quick reference and leak location. The map, based on the contractor's "as built" drawings, shows and identifies the following:

- Location of the alarm module, cable connections, and landmarks (such as walls, columns, equipment, piping).
- Cable layout.
- Actual cable distance at cable connections or mapped points.
- Potential trouble areas, such as A/C units and floor drains.



IMPORTANT: For large systems incorporating the TT-TS12 touch screen, the system map is loaded into touch screen memory and leak locations are displayed graphically.

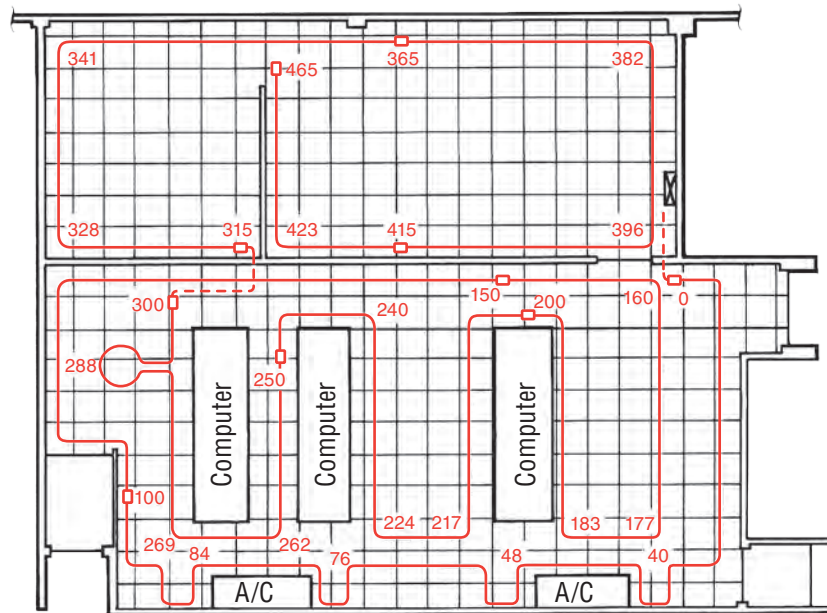



Example of a System Map

APPLICATIONS: EMERGENCY DIESEL GENERATOR

Fuel leak detection applications related to diesel generators can utilize TT5000 sensing cable and the TT-FFS Fast Fuel Detection Probe.

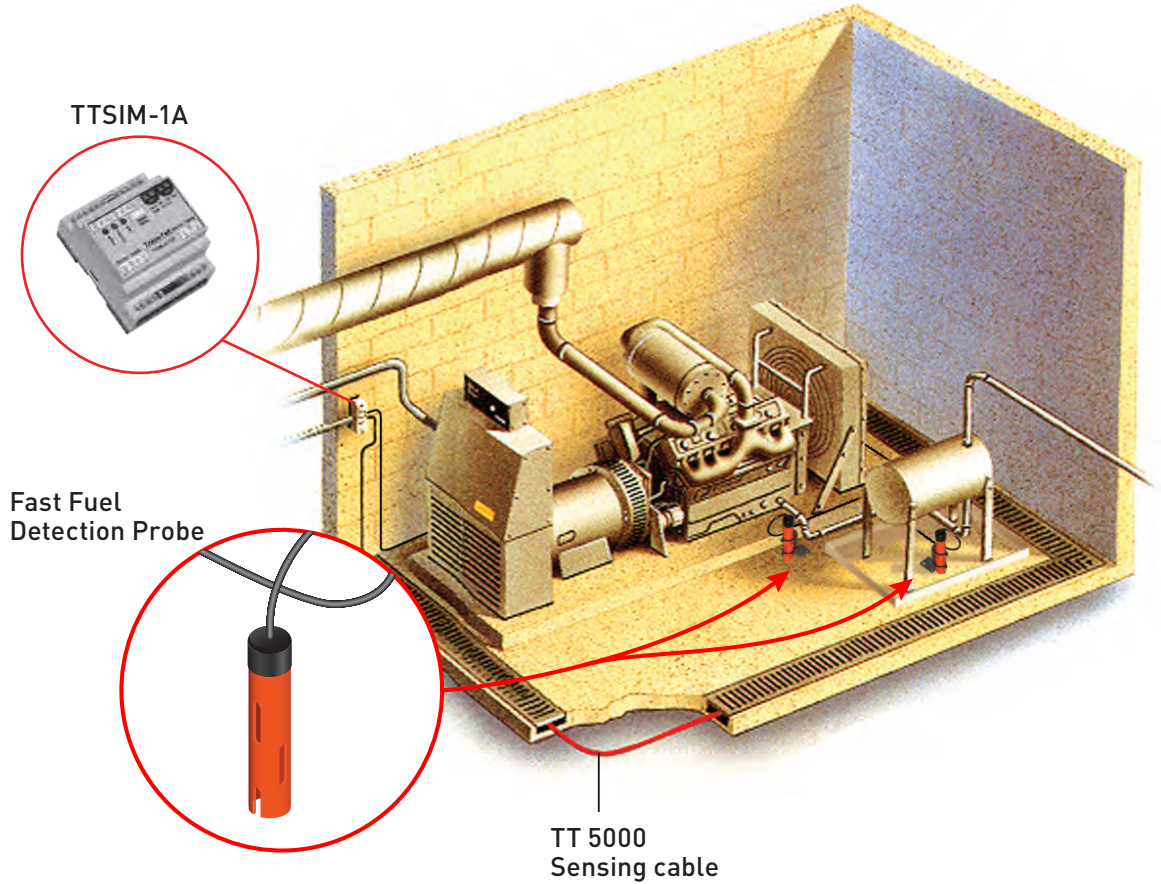
The TT-FFS is a fast acting probe designed to detect hydrocarbon fuel floating on water, spreading on a flat surface or collecting in a sump.



 **IMPORTANT:** TT5000 and TT-FFS are approved by Factory Mutual as compliant with FM 7745 Hydrocarbon leak detection standard

APPLICATIONS: BUILDING SERVICE COLUMN

- The TraceTek system can monitor many dispersed locations from one central point.
- The TT-TS12 alarm module and external TTSIM-1A units provide flexible coverage throughout a building where leak detection is needed.
- Different TraceTek sensing cables are electrically compatible and can be used within the same system.
 - TT1000 cables to detect water spills.
 - TT3000 cables to detect aqueous solution spills.
 - TT5000 cables to detect diesel fuel spills.

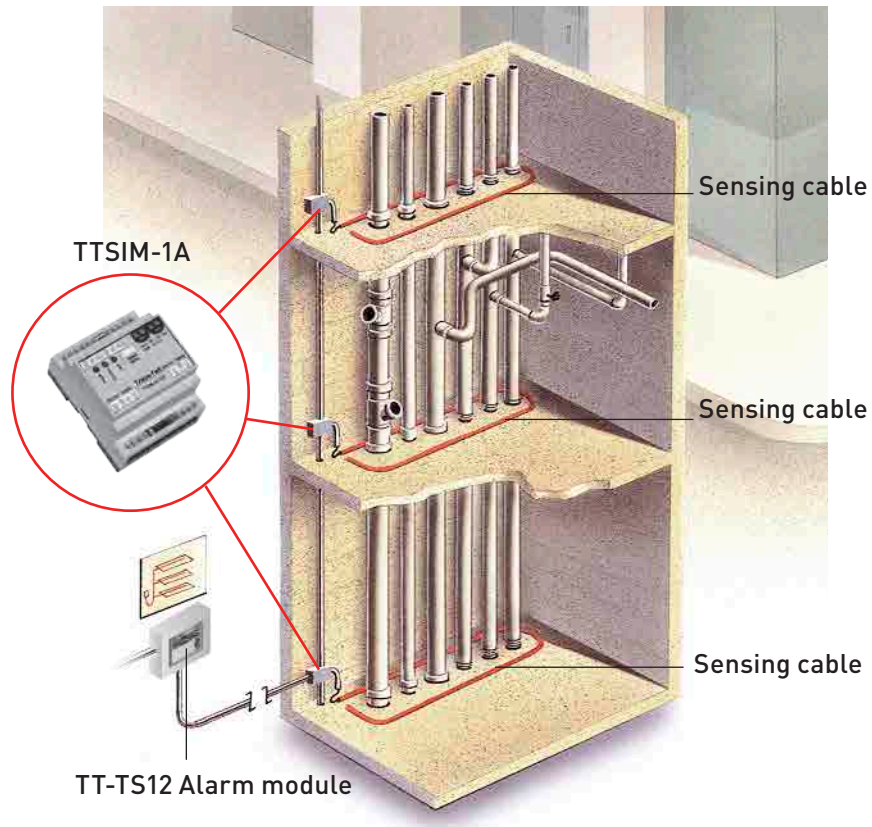

BUILDING SERVICE COLUMNS

Leaks in vertical service columns often propagate to several floors. TraceTek systems offer layout flexibility to handle widely distributed areas with branches or zones. Sensing cable on each floor provides early and quick detection—and the alarm module pinpoints the location.

APPLICATIONS: SUSPENDED PIPE

The TT1100-OHP sensing cable has been designed specifically for overhead suspended pipe applications to detect a water leak originating from a small pin hole or crack in the pipe. The wicking action of the absorptive synthetic fiber outer braid on the TT1100-OHP cable can catch and hold a small trickle of water to ensure sufficient wetted length to generate a leak alarm. Any TraceTek alarm module can be used with the TT1100-OHP sensing cable, and the cable can be integrated into any existing sensing cable circuit.

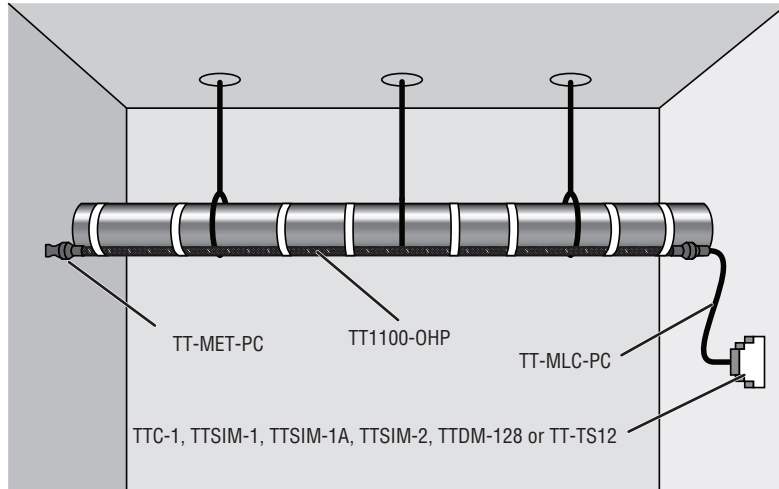

APPLICATIONS: SUMPS AND DRIP TRAYS

The TT-FLAT PROBE can detect water leaks in low spots, drip trays, or sumps where TraceTek sensing cables are inappropriate. The TT-FLAT PROBE can be interconnected with jumper cable to other TT-FLAT PROBE or TraceTek sensing cable segments and be monitored by a TT-TS12 or TTSIM alarm module.

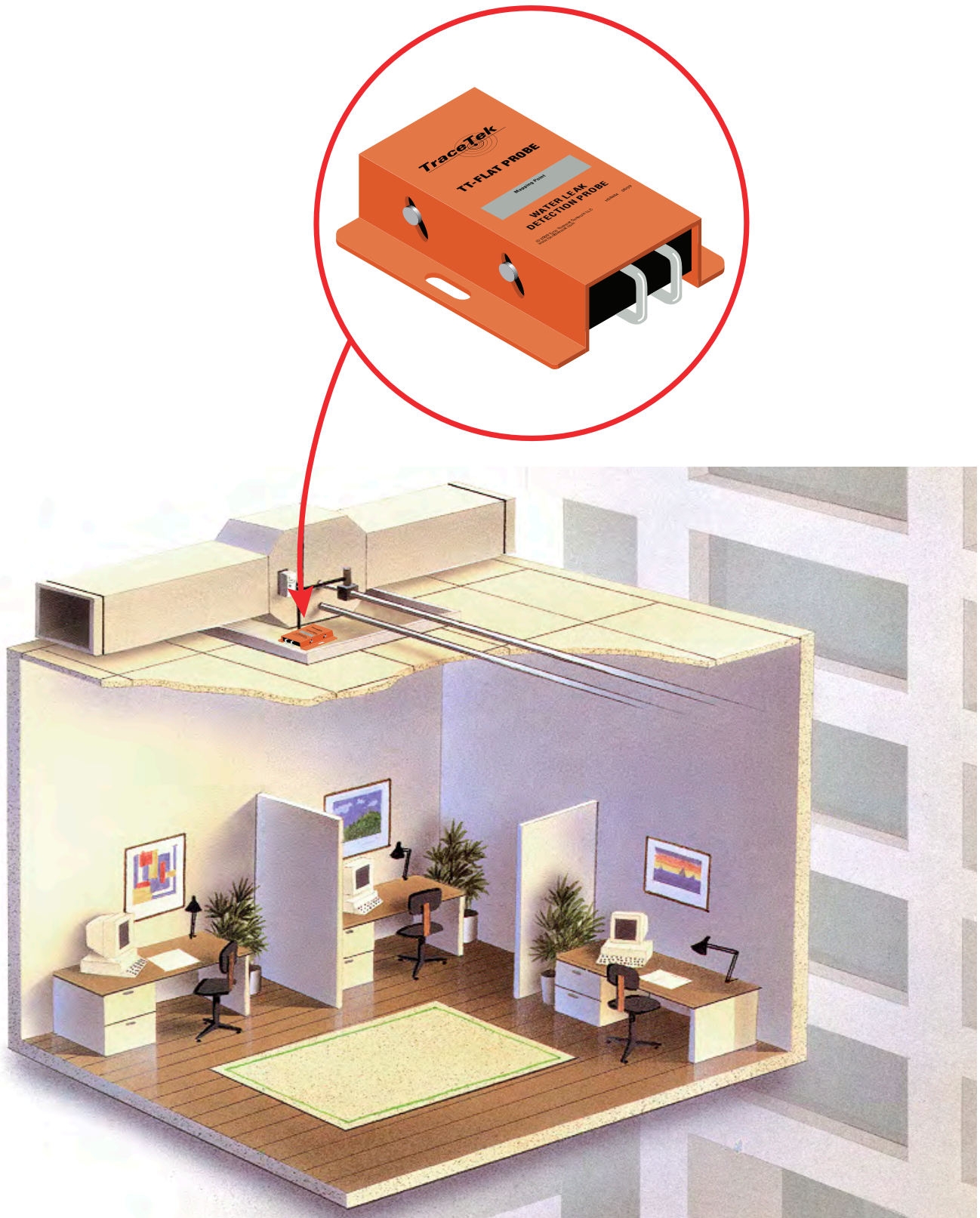

APPLICATIONS: SMALL AREA COVERAGE: BASIC TRACETEK ALARM SYSTEM

A simple cost effective TraceTek system is used to monitor small areas and provides an independent system for a separate area or operation. This type of system is useful for separate alarm annunciation or direct equipment control and is based on the TTC-1 alarm module.

Alarm relays from the TTC-1 module may be used to control equipment (e.g., close a valve), to annunciate an alarm and/or to signal an alarm to a host system.

Sensing cable can be positioned to provide complete leak detection coverage of pumps, boilers and other equipment.

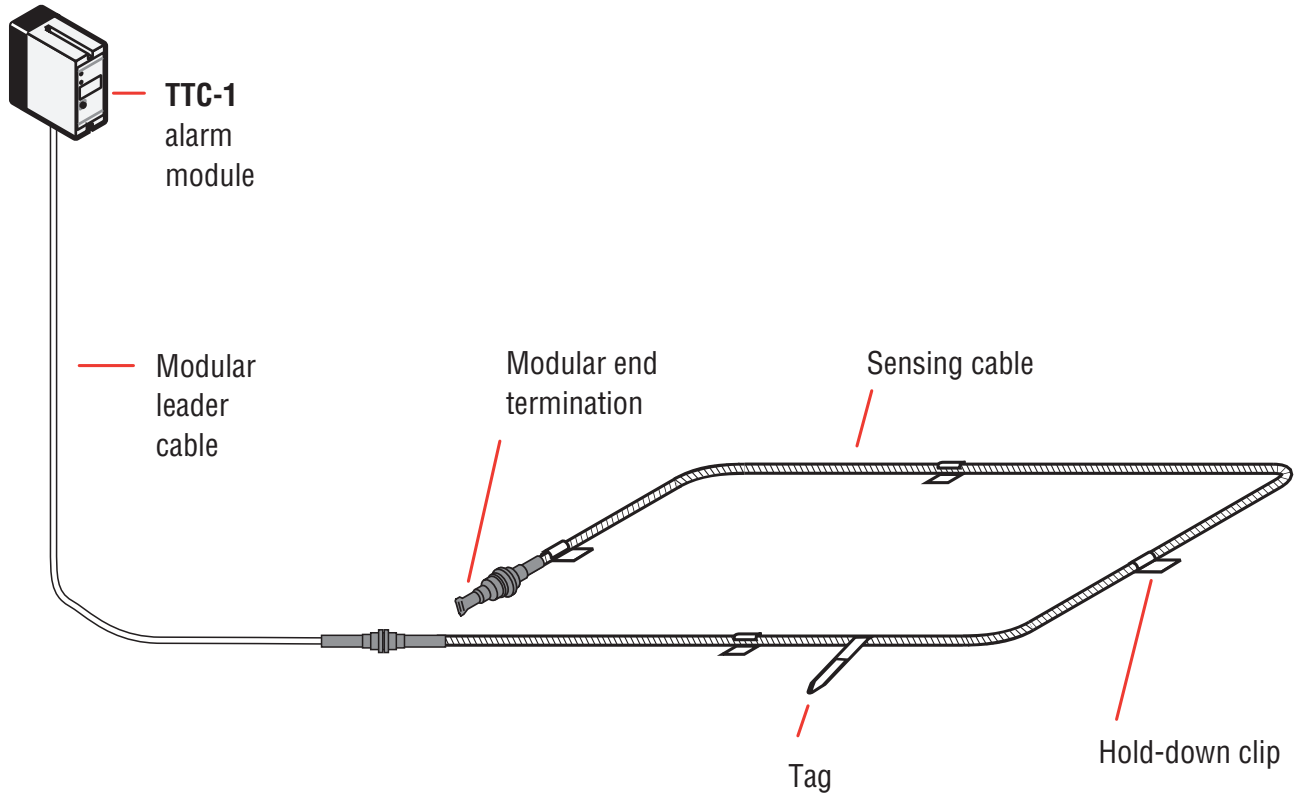

APPLICATIONS: WIDE AREA COVERAGE: TRACETEK LOCATING SYSTEM

More sophisticated systems are constructed to cover wider areas, and can provide leak locating capability by utilizing the appropriate alarm module. The illustration below shows a wide area system with multiple leak detection circuits, monitored by the TT-TS12 alarm module. A TT-MBC-PC modular branching connector has been used to create multiple sensing circuits, and weighted length (TT-WL-4.5M/15FT-PC) has been used to create additional electrical length in the sensing circuit.

The illustration represents a system map created after installation. The numbered reference points (e.g. 125 in the illustration) identify the leak location distance observed at each point in the mapping process.

During a leak event, the system map allows the leak location distance shown on the TT-TS12 to be easily related to a specific portion of the leak detection circuit.

On this illustration, **A** shows where the sensing circuit jumps to a new room and a weighted length is used. The weighted length simulates 15 feet (4.5 m) of sensing cable so the system map will show a clear division between the separate areas.

B shows a branch in the sensing circuit. A TraceTek branching connector is wired so the connected branches appear in series, middle leg first. The branching connector also adds a simulated cable length of 15 feet (4.5 m) on each branch to make a clear division between areas. Although not shown, a system may have branches within branches. The number of branches is limited only by the length of the sensing circuit.

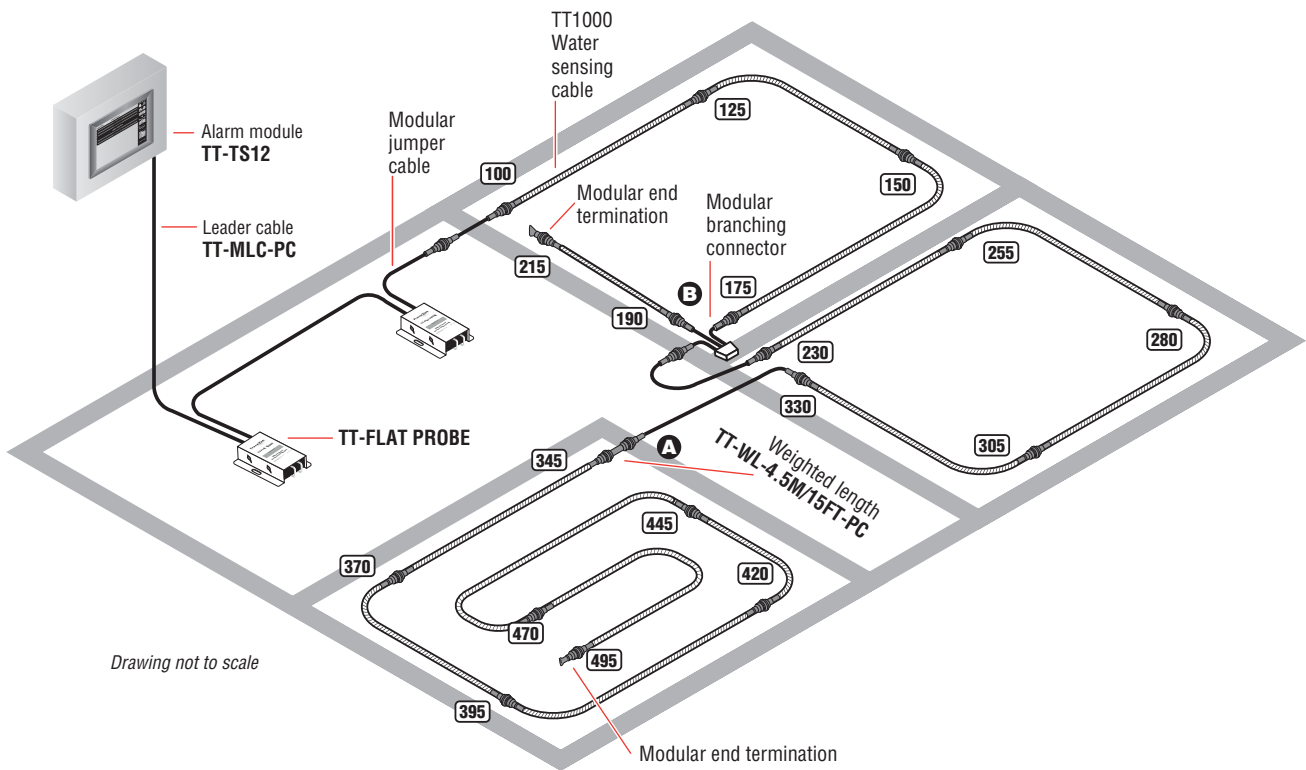

DESIGNING YOUR SYSTEM

OVER VIEW

Every TraceTek leak detection system has these basic parts:

- Sensing cable/components that make up the sensing circuit
- An Alarm Module
- Leader and/or Jumper cables that connect the alarm module to the sensing cable/components
- End termination on every leg of the sensing cable in circuit
- Accessories to secure sensing cable in place
- A system map created after Installation

SYSTEM DESIGN TYPICALLY FOLLOWS THESE STEPS

- Sensing cable/component selection
- Alarm module selection
- Plan alarm module mounting and sensing cable layout
- Define jumper cable/leader cable connections between alarm module and sensing cable
- Define sensing circuit components and accessories necessary to complete system

SENSING CABLE/COMPONENT SELECTION

Table A summarizes the TraceTek sensing cables and components related to Commercial Building applications. Multiple sensing cables and components can be used in a single sensing circuit. All items listed are compatible with any TraceTek alarm module.

One key factor to consider relative to your application is which building areas benefit from spot leak detection and which areas are best suited for sensing cable.

When deciding on how much sensing cable length or number of spot leak detection components to use, take into account the potential impact of a leak or spill, which could include injury, damage, cleanup costs, downtime and liability. Also consider the likelihood of leaks or spills, which depends heavily on application specifics such as the degree of exposure and the nature of the operations, the material handled, level of activity and maintenance practices.

Table A: TraceTek Sensing Cables/Components

Sensing Cable	Detection Type	Construction	Fluid Sensed	Typical Uses
TT1000	Continuous Cable	Solid Core, quick drying	Water; Water/Glycol Mix	Monitor for leaks under raised floors, utility rooms, flat surfaces
TT1100-OHP	Continuous Cable	Polyester Rope Overbraid, polyolefin core	Water; Water/Glycol Mix, Hot and Chilled Water	Suspended pipe, racked pipe, large drip trays, dirty areas
TT-FLAT-PROBE	Point Probe	Metallic electrodes, internal resistor network, passive device	Water, Water/Glycol mix	Smaller drip trays, under equipment, small sumps, as a 'flood' detector in damp areas
TT5000	Continuous Cable	Special construction, conductive rubber jacket, conductive polymer core	Diesel and other hydrocarbon fuels. No reaction to water	Back-up generator rooms: Diesel fuel tanks, pipes, pipe trenches, etc.
TT-FFS	Point Probe, fast action	Thin film, fast response, re-settable	Diesel and other hydrocarbon fuels. No reaction to water .	Use in high risk locations: under flex couplings, valves, pump pads, etc.

See Table 1 in Product Listing section for more extensive details regarding all TraceTek Sensing Cables/Components.

ALARM MODULE SELECTION

Table B summarizes the TraceTek Alarm Modules related to Commercial Building applications. Determining the monitoring approach for your application means making three key choices about scope:

- Areas or operations to have separate alarm and/or control
- The Alarm Modules best suited to each area
- Extent of leak detection coverage

When a leak occurs, consider how your organization must respond. If different groups are responsible for different equipment, systems or areas- then consider using separate alarm modules to make ownership clear.

When dealing with direct equipment control applications (for example, to close a valve when a leak is detected), select an alarm module with relay logic and use separate modules to control each piece of separate equipment.

If handling flammables, select the alarm module and system layout that will meet the approval requirements for your hazardous location.

The geometry and layout associated with your application is key in determining the alarm module type and number of units to use. Consider the physical size (length or area), the number of separate pipes or areas to be monitored, and accessibility.

TABLE B: TraceTek Alarm Modules

Instrument	Type	Maximum Circuit Length	Display	Data Output	Relays	Used
TTSIM-1A	Sensor Interface Module	500 ft (150 m)	Status LED only	Serial Modbus RTU Data	Single SPDT relay, can be set for LEAK only or LEAK and TROUBLE	Most common module for monitoring multiple rooms in same building
TTSIM-2	Sensor Interface Module	500 ft (150 m)	3-digit leak location display and Status LED	Serial Modbus RTU Data	Single SPDT relay, can be set for LEAK only or LEAK and TROUBLE	Used for monitoring multiple rooms in same building where location display is useful for maintenance workers
TTSIM-1	Sensor Interface Module	5000 ft (1500 m) Recommended circuit max length of 1000 m for new designs	Status LED only	Serial Modbus RTU Data	No relays	Used for larger spaces, suspended pipe, pipe in trench and other situations where circuit length more than 150 m is required
TTC-1	Sensor Interface Module	250 ft (76 m)	Status LED only	no data output	DPDT relay for LEAK SPDT relay for TROUBLE	Simple 'relay only' device used for small areas where location information is not required

TABLE B: TraceTek Alarm Modules (Continued)

Instrument	Type	Maximum Circuit Length	Display	Data Output	Relays	Used
TTDM-128	User Alarm Panel, Network Master, Built in Sensor Interface	5000 ft (1500 m) on internal card and network of up to 126 additional external TTSIM modules	4 x 20 character digital display indicating alarm and status, leak location, event history, status of internal sensor card and up to 127 additional external circuits	Full Modbus RTU /ASCII register map for all 127 channels, leak locations for multiple leaks, audible alarm, status LEDs	DPDT relay for LEAK DPDT relay for SERVICE NEEDED DPDT for TROUBLE Up to 300 user programmable SPDT relays in external add-on modules	Main User Display and System Management Panel at the core of most large leak detection systems
TT-TS12	Graphic User Interface Touch Screen Alarm/Status/Leak Location Panel with Dynamic Leak Mapping Display	Manages and displays data from network of up to 250 external TTSIM modules - no internal sensor interface circuits	12 inch SVGA display with Touch Screen user control. Master status summary, status by channel, event history, dynamic map of all detected leaks	Full Modbus RTU /ASCII register map for all 250 channels. Modbus/TCP via Ethernet connection, other protocols available	Audible alarm and summary relays available via external modules:SPST relay for LEAK, SPST relay for SERVICE NEEDED, SPST for TROUBLE Up to 300 user programmable SPDT relays in external add-on modules	Large system display and network master module. Suitable for recessed panel or wall mounting. System management and status only, no direct field wiring or sensor connections.
TTA-SIM-1A TTA-SIM-2	Self Contained Sensor Interface Module	500 ft (150 m)	Status LED, Buzzer, Lighted Alarm Silence Button 3-digit leak location display (on TTA-SIM-2) only	Serial Modbus RTU Data	Single SPDT relay, can be set for LEAK only or LEAK and TROUBLE	Small areas where semi-autonomous operation is useful. Networking capability is retained so TTA-SIM panel can sound a local alarm and be indicated at TTDM or TT-TS12 master panel location too.

See Table 2 in Product Listing section for more extensive details regarding all TraceTek Alarm Modules.

DEFINING THE REST OF THE LEAK DETECTION SYSTEM

Once you have decided on the specific Alarm Module and type of TraceTek sensing cables that will be used in your application, the following steps need to be addressed to more fully define your system:

PHYSICAL MOUNTING LOCATION OF ALL ALARM MODULES

Alarm module location needs to address considerations related to:

- Alarm annunciation
- Personnel access
- Proximity to area being monitored
- Environment suitable for monitor
- Supply of power
- Connections to host systems

SENSING CABLE/COMPONENT LAYOUT

Once you have decided on the types and quantity of sensing cable and sensing components to be used, create a system layout. Confirm that the layout provides the desired coverage.

JUMPER CABLE/LEADER CABLE CONNECTIONS

The alarm modules and sensing cable are wired together using modular jumper cable (MJC) and modular leader cable (MLC).

MJC-PC and MLC-PC are used with TT1000 and TT1100-OHP since these sensing cables utilize the plastic connector.

MJC-MC-BLK and MLC-MC-BLK are used with TT5000 and TT-FFS since these sensing cables/components utilize the metal connector.

For short distances between the alarm module and sensing cable, modular leader cable (MLC) is used. For longer distances, sections of modular jumper cable (MJC) are used between the modular leader cable (MLC) and sensing cable.

See Table 3 for more details on the selection of jumper cable and modular leader cable.

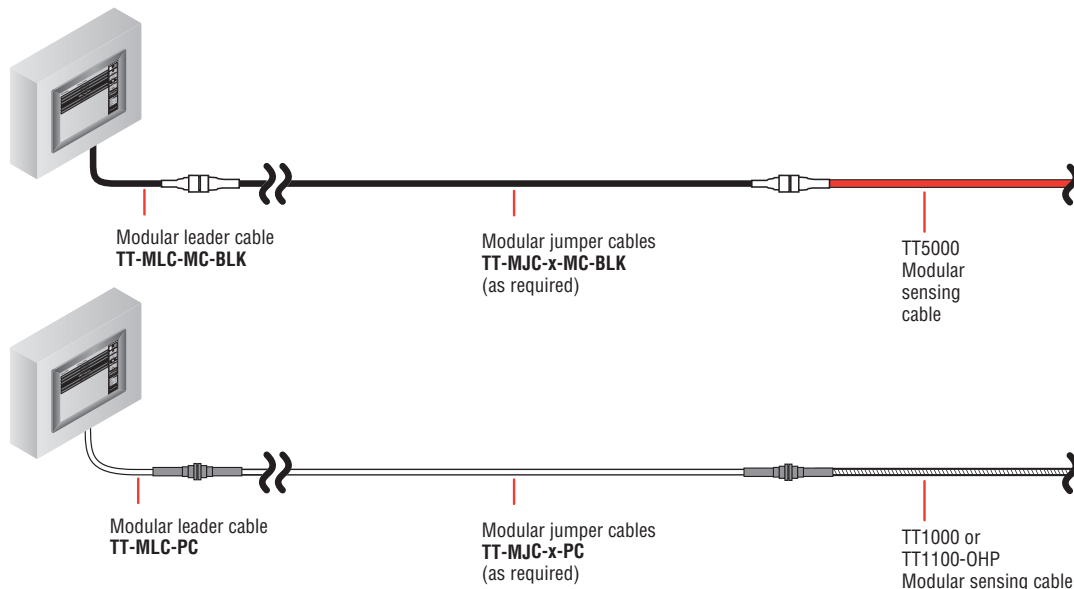

SENSING CIRCUIT COMPONENTS

Select required circuit components relative to the system layout. See Table 4 for more details on the modular branch connector (MBC), end terminations (MET) and weighted lengths (WL) that can be used in the sensing circuit.

CONNECTOR KITS

See Table 5 for information regarding the selection of appropriate Connector Kit to be used in the event your application uses bulk cable.

ACCESSORIES

See Table 6 for information regarding the Accessories that can be used in your application.

TOOLS

See Table 7 for information regarding the Tools that may be needed in your application.

Product Listings

Table 1: Sensing Cables/Components

TT1000 cable



Modular TT1000 water sensing cable lengths with factory installed connectors, pin type plastic connector at one end and socket type plastic connector at other end. See TT1000 Data Sheet H53870 for details, including part numbers.

Standard lengths as shown below:

TT1000-1M/3FT-PC	TT1000-3M/10FT-PCT	T1000-5M/17FT-PC
TT1000-7M/25FT-PC	TT1000-15M/50FT-PC	TT1000-30M/100FT-PC
TT1000-50M/165FT-PC		

Bulk TT1000 cable

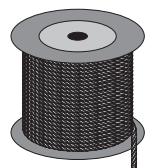

TT1000 water sensing cable on reel without connectors. Cable length per reel can be minimum 250ft (75 m) to maximum 1000ft (300 m). Length specified at time of order. Connector kits are required and must be purchased separately. See TT1000 Data Sheet H53870 for details, including part numbers.

TT1000-SC

TT1100-OHP cable

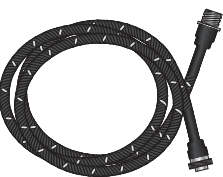

Modular TT1100-OHP water sensing cable lengths with factory installed connectors, pin type plastic connector at one end, and socket type plastic connector at other end. See TT1100-OHP Data Sheet H58260 for details, including part numbers. TT1100-OHP cable is ideally suited for overhead suspended pipe applications.

Standard lengths as shown below:

TT1100-OHP-1M-PC	TT1100-OHP -3M-PC	TT1100-OHP -7.5M-PC
TT1100-OHP -15M-PC	TT1100-OHP -30M-PC	TT1100-OHP -50M-PC
TT1100-OHP -100M-PC		

TT1100-OHP-XX-PC User definable custom length between 1 and 500ft

Bulk TT1100-OHP cable

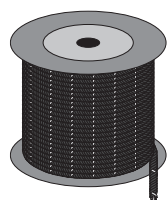

TT1100-OHP water sensing cable on reel without connectors. Cable length per reel can be minimum 250ft (75 m) to maximum 1000ft (300 m). Length specified at time of order. Connector kits are required and must be purchased separately. See TT1100-OHP Data Sheet H58260 for details, including part numbers. TT1100-OHP cable is ideally suited for overhead suspended pipe applications.

TT1100-OHP-SC

TT-FLAT PROBE

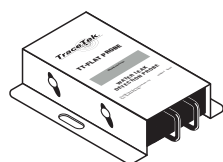

TT-FLAT PROBE is a special purpose probe to detect water leaks in low spots, drip trays or sumps-where TraceTek sensing cables are inappropriate. The TT-FLAT PROBE can be interconnected with jumper cable to other TT-FLAT PROBE or TraceTek sensing cable segments, and can be monitored with an alarm module. See TT-FLAT PROBE Data Sheet H58462 for details, including part numbers.

TT-MINI-PROBE



The TT-MINI-PROBE is a cost effective solution for low point leak detection. It is a special purpose probe designed to detect electrically conductive fluid leaks in space limited locations. The TT-MINI-PROBE can be interconnected with jumper cable and branching connectors to other TT-MINI-PROBE or TraceTek sensing cable segments, and be monitored by an alarm module.

TT-FLOAT SWITCH-GEMS

This Float Switch is used in applications where background moisture is present and needs to be ignored. Part number is 136395-000.

TT5000 cable

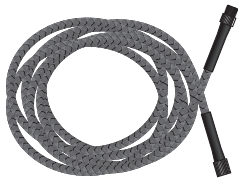

Modular TT5000 fuel sensing cable lengths with factory installed connectors, pin type metal connector at one end, and socket type metal connector at other end. See TT5000 Data Sheet H54785 for details, including part numbers.

Standard lengths as shown below:

TT5000-0.3M/1FT-MC	TT5000-1.5M/5FT-MC	TT5000-3M/10FT-MC
TT5000-4.5M/15FT-MC	TT5000-7.5M/25FT-MC	TT5000-15M/50FT-MC
TT5000-30M/100FT-MC		

Bulk TT5000 cable

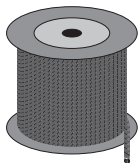

TT5000 fuel sensing cable on reel without connectors. Cable length per reel can be minimum 100ft (30m) to maximum 800ft (240m). Length specified at time of order. Connector kits are required and must be purchased separately. See TT5000 Data Sheet H54785 for details, including part numbers.

TT5000-SC

TT5000 ZONE cable



Modular TT5000 fuel sensing cable, prepared for ZONE system. Factory installed pin type metal connector at one end, with heat shrink covered terminated end. Note that the terminated end does not provide for adding any extra cable, meaning the cable circuit terminates at this point. See TT5000 Data Sheet H54785 for details, including part numbers.

TT5000-1.5M/5FT-HSE-MC

TT-FFS



TraceTek Fast Fuel Sensor is a fast acting fuel detection probe designed to detect hydrocarbon fuel floating on water, or spreading on a flat surface. The TT-FFS probe comes in two different active region lengths (-100 or -250 models). The TT-FFS probe comes in two different wiring configurations also (-MC or L). The -MC configuration uses a factory installed pin type metal connector, while the -L configuration uses a 4 wire connection intended for use with an alarm module. The TT-FFS probe can be ordered with three different lengths of leader cable (1 or 3 or 10ft) for flexibility in field installations. See TT-FFS Data Sheet H57977 for details, including part numbers.

TT-FFS probes can be selected from the list below:

TT-FFS-100-1-L	TT-FFS-100-1-MC
TT-FFS-100-3-L	TT-FFS-100-3-MC
TT-FFS-100-10-L	TT-FFS-100-10-MC
TT-FFS-250-1-L	TT-FFS-250-1-MC
TT-FFS-250-3-L	TT-FFS-250-3-MC
TT-FFS-250-10-L	TT-FFS-250-10-MC

Table 2: Alarm Modules

TT-TS12



Graphic User Interface that provides Leak Alarm/Status/Location information and dynamic leak mapping display. Manages and displays data from network of up to 250 external TTSIM modules. No internal sensor interface circuits. See TT-TS12 datasheet H80617 for details, including part numbers.

TTTDM-128

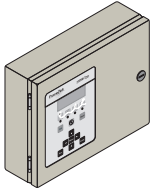

Locating alarm module can monitor up to 5000 ft (1500 m) of sensing cable. Metal enclosure, TYPE 12. Status LED's, audible alarm, Data logging. Three Form C (DPDT) relay contact. 4-20 mA analog output, serial port configurable for RS-232 or RS-485. See TTD-128 Data Sheet H56859 for details, including part numbers.

TTDM-128 115V + 15%, -20%; 230V +/- 10%; 50/60Hz

TTDM-128-24V 24V AC + 5%, -35%; 24V DC +/- 20%

TTC-1



Nonlocating single channel alarm module. 24V supply. Monitors up to 100ft (30 m) of sensing cable. Plastic enclosure, TYPE 1. Outputs 3 Status LED's. See TTC-1 Data Sheet H53587 for details, including part numbers. Comes with one DPDT form C relay (leak) and one SPDT form C relay (fault).

TTSIM-1

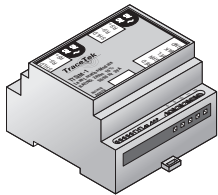

Locating alarm module can monitor up to 5000 ft (1500 m) of sensing cable. Best suited for applications where large areas are being monitored, or long circuit lengths required. Status LED's, No relay contacts. See TTSIM-1 Data Sheet H56858 for details, including part numbers.

TTSIM-1 22 to 26Vac, 50/60Hz, 3W (Selv level for Europe)

TTSIM-1-12VDC 12Vdc +/- 10%, 2W

TTSIM-1-24VDC 24Vdc +/- 10%, 2W

TTSIM-1A



Locating alarm module can monitor up to 500 ft (150 m) of sensing cable. Status LED's, and Form C (SPDT) relay contact. See TTSIM-1A Data Sheet H57387 for details, including part numbers.

TTSIM-1A 2 to 26Vac, 50/60Hz, 3W (Selv level for Europe)

TTSIM-1A-120 92 to 132Vac, 50/60Hz, 3W

TTSIM-1A-230 216 to 253Vac, 50/60Hz, 3W

TTSIM-1A-12VDC 12Vdc +/- 10%, 2W

TTSIM-1A-24VDC 24Vdc +/- 10%, 2W

TTSIM-2



Locating alarm module can monitor up to 500 ft (150 m) of sensing cable. LCD to display leak location. Status LED's, and Form C (SPDT) relay contact. See TTSIM-2 Data Sheet H57436 for details, including part numbers.

TTSIM-2A	22 to 26Vac, 50/60Hz, 3W Selv
TTSIM-2A-120	92 to 132Vac, 50/60Hz, 3W
TTSIM-2A-230	216 to 253Vac, 50/60Hz, 3W
TTSIM-2A-12VDC	12Vdc +/- 10%, 2W
TTSIM-2A-24VDC	24Vdc +/- 10%, 2W

TTA-SIM



Locating alarm module housed in rugged polycarbonate enclosure for tough environments. 60dB alarm with silence button. Can monitor up to 500 ft (150 m) of sensing cable. Status LED's, and Form C (SPDT) relay contact. See TTA-SIM Data Sheet H57540 for details, including part numbers.

TTA-SIM-1A-120	92 to 132Vac, 50/60Hz, 3W
TTA-SIM-1A-230	216 to 253Vac, 50/60Hz, 3W
TTA-SIM-2A-120	92 to 132Vac, 50/60Hz, 3W with LCD leak location display
TTA-SIM-2A-230	216 to 253Vac, 50/60Hz, 3W with LCD leak location display

TTE-XAL

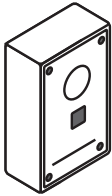

External audible alarm. 95dB alarm triggered by relay closure; requires 24V supply. Part number is 418569-000.

Table 3: Jumper Cable and Leader Cable

TT-MJC-X-PC

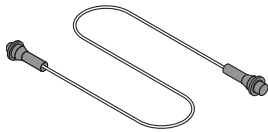

Modular Jumper cable with plastic connector and clear halar jacket. Pin type plastic connector at one end and socket type plastic connector at other end.

Can be obtained in standard lengths with factory installed connectors as shown below:

TT-MJC-1M/3FT-PC	Part number is 740923-000.
TT-MJC-3M/10FT-PC	Part number is 836567-000.
TT-MJC-7M/25FT-PC	Part number is 813259-000.
TT-MJC-15M/50FT-PC	Part number is 783027-000.
TT-MJC-30M/100FT-PC	Part number is 050533-000.

Bulk JC jumper cable

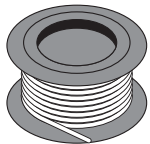

Jumper cable (clear halar jacket) in bulk, without any connectors

Can be obtained on reels, in lengths shown below:

TT-JC	250 ft min, 1000 ft max per reel. Part number is 341523-000.
TT-JC-76M/250FT	250 ft on reel. Part number is 494953-000.

TT-MLC-PC

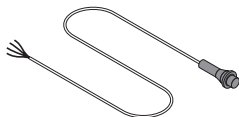

Modular Leader cable with plastic connector and clear halar jacket, length of 12ft (3.5 m). One end prepared for terminal connection in alarm module (or for splicing to bulk jumper cable) and other end prepared with socket type plastic connector. Includes connector oversleeve. Part number is 683262-000.

TT-MJC-X-MC-BLK

Modular Jumper cable with metal connector and heavy black jacket. Pin type metal connector at one end and socket type metal connector at other end.

Can be obtained in standard lengths with factory installed connectors as shown below:

TT-MJC-1M/3FT-MC-BLK Part number is 726164-000.

TT-MJC-3M/10FT-MC-BLK Part number is 709898-000.

TT-MJC-7.5M/25FT-MC-BLK Part number is 693994-000.

TT-MJC-15M/50FT-MC-BLK Part number is 678452-000.

TT-MJC-30M/100FT-MC-BLK Part number is 664356-000.

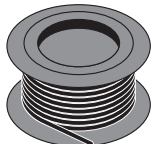
Bulk JC-BLK jumper cable

Jumper cable (heavy black jacket) in bulk, without any connectors

Can be obtained on reels, in lengths shown below:

TT-JC-BLACK 250 ft min, 1000 ft max per reel. Part number is 828281-000.

TT-JC-76M/250FT-BLK 250 ft on reel. Part number is 704628-000.

TT-MLC-MC-BLK

Modular Leader cable with metal connector and heavy black jacket, length of 12ft (3.5 m). One end prepared for terminal connection in alarm module (or for splicing to bulk jumper cable) and other end prepared with socket type metal connector. Includes connector oversleeve. Part number is 133332-000.

Table 4: Sensing Circuit Components**TT-MET-PC**

Modular end termination with pin type plastic connector. Required at end of sensing circuit and all branches. Part number is 169905-000.

TT-MBC-PC

Modular branching plastic connector with clear halar jacket. Allows a “T” or branch in the sensing circuit. The single pin type connector is connected to the cable from the alarm module. The two other socket type connectors will connect to the two branch segments. The branch connector makes a clear division between branches by wiring the branches in series with a simulated length of 15 ft (4.5 m) between branches. Part number is 847529-000.

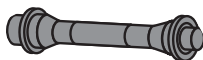
TT-WL-4.5M/15FT-PC

A weighted length is used to provide clear division between areas in a sensing circuit. The weighted length simulates 15 ft (4.5 m) of sensing cable length. It has a pin type plastic connector at one end, and socket type plastic connector at other end. Part number is 299677-000.

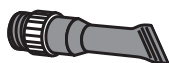
TT-MET-MC

Modular end termination with pin type metal connector. Required at end of sensing circuit and all branches. Part number is 571293-000.

TT-MBC-MC-BLK

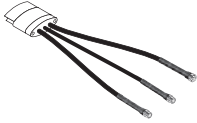

Modular branching metal connector with heavy black jacket. Allows a “T” or branch in the sensing circuit. The single pin type connector is connected to the cable from the alarm module. The two other socket type connectors will connect to the two branch segments. The branch connector makes a clear division between branches by wiring the branches in series with a simulated length of 15 ft (4.5 m) between branches. Part number is 759493-000.

TT-WL-4.5M/15FT-MC



A weighted length is used to provide clear division between areas in a sensing circuit. The weighted length simulates 15 ft (4.5 m) of sensing cable length. It has a pin type metal connector at one end and socket type metal connector at other end. Part number is 040821-000.

Table 5: Connector Kits for Bulk TraceTek cable

TT1000 cable Connector kit	<p>When using TT1000 bulk cable, a connector kit is required to construct the pin type (M) and socket type (F) connectors necessary for cable installation. Suitable connector kits are shown below. See Connector Kit Installation Instructions document H56867 for details, including part numbers.</p> <p>TT-1000/JC-CK-PC-M/F-100 (which provides for 100 M and 100F connectors) TT-1000/JC-CK-PC-M/F (which provides for 10 M and 10F connectors)</p>
TT1100-OHP cable Connector kit	<p>When using TT1100-OHP bulk cable, a connector kit is required to construct the pin type (M) and socket type (F) connectors necessary for cable installation. Suitable connector kits are shown below. See Connector Kit Installation Instructions document H58558 for details, including part numbers.</p> <p>TT-1100-OHP-CK-PC-M/F (which provides for 10 M and 10F connectors)</p>
TT-JC (-PC) cable Connector kit	<p>For TT-JC bulk cable PLASTIC connector applications, a connector kit is required to construct the pin type (M) and socket type (F) connectors necessary for cable installation. Suitable connector kits are shown below. See Connector Kit Installation Instructions document H56867 for details, including part numbers.</p> <p>TT-1000/JC-CK-PC-M/F-100 (which provides for 100 M and 100F connectors) TT-1000/JC-CK-PC-M/F (which provides for 10 M and 10F connectors)</p>
TT5000 cable Connector kit	<p>When using TT5000 bulk cable, a connector kit is required to construct the pin type (M) and socket type (F) connectors necessary for cable installation. Suitable connector kits are shown below. See Connector Kit Installation Instructions document H54830 for details, including part numbers.</p> <p>TT-5000-CK-MC-M/F (which provides for 5 M and 5 F connectors) TT-5000-CK-MC-M (which provides for 1 M connector) TT-5000-CK-MC-F (which provides for 1 F connector)</p>
TT-JC (-MC)-BLK cable Connector kit	<p>For TT-JC-BLK bulk cable METAL connector applications, a connector kit is required to construct the pin type (M) and socket type (F) connectors necessary for cable installation. Suitable connector kits are shown below. See Connector Kit Installation Instructions document H55005 for details, including part numbers.</p> <p>TT-JC-CK-MC-M/F (which provides for 5 M and 5 F connectors) TT-JC-CK-MC-M (which provides for 1 M connector) TT-JC-CK-MC-F (which provides for 1 F connector)</p>
TT-JC cable Connector kit	<p>For TT-JC bulk cable, a Jumper Splice Kit is available. The kit includes parts for 5 splices, along with 5 connector oversleeves. See Installation Instructions document H55177 for details.</p> <p>TT-JSK-HS-18 (part number 673717-000)</p>

Table 6: Accessories

TT-HDC-1/4/200-NA



TT1000 cable can be secured to flat surfaces using ¼ inch size Hold-down clips WITHOUT adhesive. Use 1 hold-down clip for each 4 ft (1.3 m) of sensing cable. Quantity of 200 clips in each bag. Part number is 168769-000.

TT-HDC-1/4



TT1000 cable can be secured to flat surfaces using ¼ inch Hold-down clips WITH adhesive. Use 1 hold-down clip for each 4 ft (1.3 m) of sensing cable. Quantity of 50 clips in each bag. Part number is 590645-000.

TT-HDC-1/2-NA-50



TT5000 cable can be secured to flat surfaces using ½ inch Hold-down clips WITH adhesive. Use 1 hold-down clip for each 4 ft (1.3 m) of sensing cable. Quantity of 50 clips in each bag. Part number is 165879-000.

TT-TAG

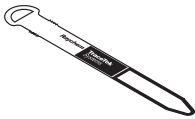

Tags are used to identify TraceTek sensing cable segments and record mapped distance. Tag attaches to sensing cable by closing on itself (like a cable tie). Package contains 50 high-visibility yellow tags and a permanent marker. Use a tag on each length of cable and at mapping points. Part number is 407347-000.

TT-COS

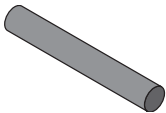

Connector oversleeves are heat shrink tubing segments used to cover metal connectors after installation. Part number is 642079-000. **IMPORTANT:** All TraceTek products with metal connectors include a heat shrink tubing segment for each connector. TT-COS makes extra connector oversleeves available for maintenance and other purposes.

TT-MAPPING CAP-PC



This Mapping Cap is PC style, and is used during the mapping process on cable systems with plastic connectors to simulate a leak at the end of the cable segment. This part is used only during the mapping process, and is not intended for any other use in the cable system. It does not replace an end termination. Part number is P000000872.

TT-MAPPING CAP-MC



This Mapping Cap is MC style, and is used during the mapping process on cable systems with metal connectors to simulate a leak at the end of the cable segment. This part is used only during the mapping process, and is not intended for any other use in the cable system. It does not replace an end termination. Part number is P000000871.

TT-MAP-TOOL

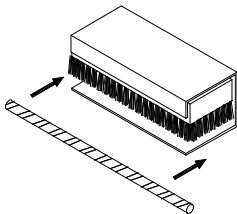

The Map Tool is also called a Mapping Brush. It provides an alternate method of simulating a leak on sensing cable segments without any rope overbraid. Part number is E43135-000.

TT-FFS-MOUNTING-BRACKET

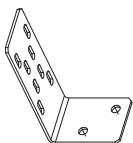

This Stainless Steel L shaped bracket is provided with cable ties to secure the TT-FFS probe vertically. Fabricated slots accommodate mounting screws that secure the bracket to the mounting surface. Part number is P000001040.

Table 7: Tools

TT-PTB-1000

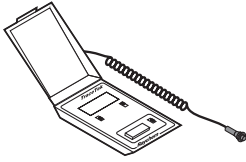

Portable Test Box. Battery operated device for testing TraceTek sensing cables. Allows testing of an individual length or up to 2000ft (1000 m) of sensing cable. Useful for installation and maintenance of extensive systems. TT-PTB-1000 has plastic socket connector on flexible cord. Test box kit includes adaptors (plastic-to-metal and plastic-to-alligator clip) along with modular end terminations. Part number is 486437-000.

TT-ADAPTOR-KIT



Optional kit useful for testing systems with metal connectors. Includes several adaptors with metal connectors: Y adaptor with both pin and socket, socket-to-socket adaptor, pin-to-pin adaptor and end termination with socket adaptor. Part number is 646003-000.

TT-ULTRA-TORCH



Flameless heating tool used during Installation of certain TraceTek bulk sensing cable Connector Kits. Part number is 390067-000.

TT-STRIPPER

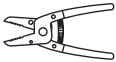

Wire Strip Tool used during Installation of certain TraceTek bulk sensing cable Connector Kits. Part number is 358979-000.

TT-CT-SCT-3000



Crimp Tool used during Installation of certain TraceTek bulk sensing cable Connector Kits. Part number is 644333-000.

TT-AD-1522-1-CRIMPING-TOOL

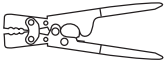

Model AD-1522 Crimp Tool used to properly crimp connectors in TT-JSK-HS-18 jumper splice kit. Part number is 047011-000.

TT-FFS-PROBE-TESTER

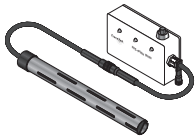

The TT-FFS PROBE TESTER is a battery powered device that provides the capability of testing a TT-FFS probe to determine if it is working properly. Part number is P000001048. See TT-FFS-PROBE-TESTER Data Sheet H58497 for details.



WWW.PENTAIRTHERMAL.COM

NORTH AMERICA

Tel: +1.800.545.6258
Tel: +1.650.216.1526
Fax: +1.800.527.5703
Fax: +1.650.474.7215
thermal.info@pentair.com

EUROPE, MIDDLE EAST, AFRICA

Tel: +32.16.213.511
Fax: +32.16.213.603
thermal.info@pentair.com

ASIA PACIFIC

Tel: +86.21.2412.1688
Fax: +86.21.5426.2917
cn.thermal.info@pentair.com

LATIN AMERICA

Tel: +713.868.4800
Fax: +713.868.2333
thermal.info@pentair.com

Pentair and TraceTek are owned by Pentair or its global affiliates. All other trademarks are the property of their respective owners. Pentair reserves the right to change specifications without prior notice.