



CONNECT AND PROTECT

Hazardous Location Solutions

nvent

HOFFMAN

Proven Protection to Reduce Risk

NVENT HOFFMAN HAZARDOUS LOCATION SOLUTIONS INCREASE SAFETY AND MEET GLOBAL STANDARDS



EQUIPMENT PROTECTION FOR CLASSIFIED HAZARDOUS LOCATIONS

HOFFMAN offers an extensive line of enclosures and products to safely house electrical systems and electronic components in environments subject to potentially hazardous atmospheres created by vapor or dust including:

- Onshore and offshore oil and gas
- Chemical and petrochemical
- Pulping and paper plants
- Pharmaceutical
- Grain processing and storage

HOFFMAN hazardous location enclosures also offer protection against corrosive conditions and condensation, humidity, high internal and external temperatures, and weather extremes.



HOFFMAN ZONEX ENCLOSURES



ATEX- AND IECEX-CERTIFIED ENCLOSURE PLATFORM

Zonex enclosures and junction boxes are designed and certified to meet ATEX Directive 94/9/EC for "increased safety" (Ex e) applications, acceptable to safely house electrical components in Zone 1 and Zone 2 rated areas. Zonex enclosures are offered in hinge-cover and screw-cover models in Type 316 stainless steel and non-metallic compression molded fiberglass in an extensive range of standard sizes. Hinge-cover enclosures are available in inch- and metric-dimensioned models for global deployment. A wide selection of gland plates and panels are available to meet a host of termination and junction application requirements.

THERMAL MANAGEMENT

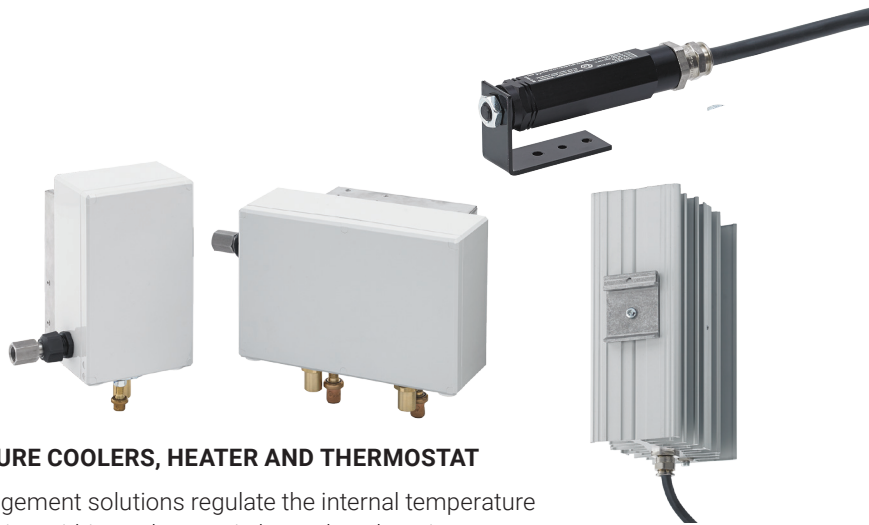

VORTEX A/C ENCLOSURE COOLERS, HEATER AND THERMOSTAT

Certified thermal management solutions regulate the internal temperature and mitigate condensation within enclosures in hazardous locations.

ACCESSORIES



BREATHER DRAINS, HOLE SEALS, WINDOW KITS AND INTERNAL LED LIGHTING

Certified for use in hazardous applications, HOFFMAN accessories provide low-maintenance options to enhance enclosure performance and function in the most demanding conditions.

PURGE AND PRESSURIZATION



CONTROLLERS, RELIEF VALVES, AND SPARK ARRESTORS

Enclosures with purge/pressurization systems remove potentially hazardous atmospheres from enclosures and replace it with inert gas or air at a pressure sufficient to prevent ingress of ambient air. Equipped enclosures can house and allow operation of general purpose equipment not otherwise approved for use in hazardous areas. Systems include dual-rated ATEX, IECEx, and NFPA Type Y and Z, or Type X, for use in classified hazardous environments.

For Specific Oil and Gas Solutions, Come to HOFFMAN

OPTIMIZE YOUR HAZARDOUS LOCATION APPLICATION WITH FLEXIBLE ENCLOSURE DESIGN, MODIFICATIONS, AND ACCESSORIES

DESIGN YOUR ENCLOSURE EXACTLY HOW YOU NEED IT

More selection. More flexibility. More service. Unlimited possibilities. That's Excelerate – the fastest way to get exactly what you need with advantages only HOFFMAN can offer:

- Industry-leading selection of products, sizes, configurations, accessories and options
- Standard products can be modified while maintaining agency certifications via on-site certified test lab
- Freestanding and multi-bay configurations
- Most standard products available off-the-shelf
- New Online Modification Tool lets you build the exact enclosure and protection features you need
- HOFFMAN ships your modified enclosure in as few as 10 days

Start with a standard and select from thousands of common modifications including:

- Dimension changes
- Holes and cutouts
- Paint colors and finish options
- Material selections
- Door and latching accessories
- Mounting options
- Panels and sub-panels
- Power provisions
- Cable management
- Cooling options

CERTIFIED ASSEMBLY PROGRAM

HOFFMAN offers a certified assembly program that allows approved companies to provide value-added services:

- Populating enclosures with terminal blocks
- Modifying enclosures with holes, cutouts, cable glands, and customer tags
- Provides ATEX / IECEx certificate for assembled enclosure

Contact your HOFFMAN sales representative for more information.

IECEx and ATEX certified window kits



Custom enclosure holes and cutouts



Purge relief valves

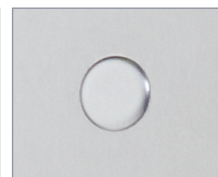

Breather drains and hole seals that maintain ratings and certifications

1/4-turn, slotted, or 3 mm double bit inserts



High-temperature silicone gaskets



Heavy-duty steel plinth base for stability in high-wind or high-vibration applications

Interior configurations to meet your application needs

- Terminal block installation and labeling
- DIN rails or back panels
- Modify mounting brackets

WEATHER SHIELDS

- Protect against excessive heat, UV exposure, or driving rains
- Available in many configurations and sizes



Material changes with Type 304/316 stainless steel, aluminum, and mild steel available

Vortex A/C Enclosure Coolers regulate internal temperature



Purging/pressurization system supplies enclosure with a protective gas supply

FREESTANDING ENCLOSURE

- Certified ATEX and IECEx
- Up to 6 door bays

HEIGHTS 10-90 INCHES	WIDTHS PER DOOR 10-36 INCHES	DEPTHS 5-36 INCHES
-----------------------------------	--	---------------------------------

Super durable paints provide corrosion protection in harsh and hazardous applications

HOFFMAN Zonex

NON-METALLIC GRP ENCLOSURES

FEATURES

- Corrosion resistant for long service life with glass reinforced polyester (GRP) and Type 316 stainless steel fasteners
- Easy installation with molded in place mounting dimensions and internal stainless steel inserts for DIN rails and panels
- Secure sealing to protect equipment with continuous silicone gasket ideal delivering Type 4X and IP66 ratings

SPECIFICATIONS

- Made of glass-reinforced polyester for high impact strength
- Wide temperature range (-50 to 100 C, -58 to 212 F)

CERTIFICATIONS

- Zone 1 or 2 classified areas
- IECEx, ATEX, and AEx approvals
 - Ex e IIC Gb
 - Ex ta IIIC Da IP66
- UL 508 / cUL Type 4, 4X & 12
- NEMA / EEMAC Type 4, 4X, 12
- IEC IP66 Rated



NON-METALLIC ATEX (Standard Sizes)

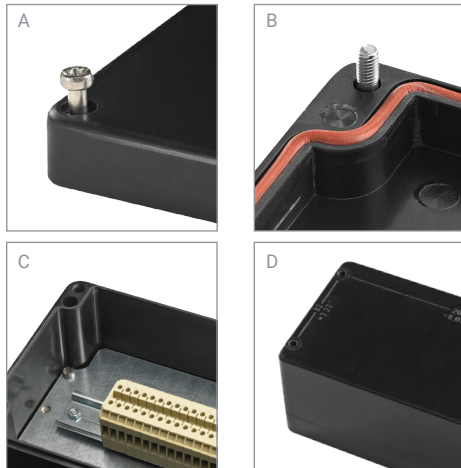

- Retained combination-head cover screws
- High-temperature silicon gasket positioned into groove on cover produces labyrinth seal
- Off-the-shelf internal panels save time and money
- Molded-in inch and metric dimension data for hole-to-hole enclosure mounting

Catalog Number	Description (mm)	Panel*	Panel Material	Panel Size (mm)
EXE807555	Ex e 80 x 75 x 55 composite Type 4X Black	A8075P	Composite	69 x 64 x 2
EXE807575	Ex e 80 x 75 x 75 composite Type 4X Black	A8075P	Composite	69 x 64 x 2
EXE1107555	Ex e 110 x 75 x 55 composite Type 4X Black	A11075P	Composite	99 x 64 x 2
EXE1107575	Ex e 110 x 75 x 75 composite Type 4X Black	A11075P	Composite	99 x 64 x 2
EXE1607555	Ex e 160 x 75 x 55 composite Type 4X Black	A16075P	Composite	149 x 64 x 2
EXE1607575	Ex e 160 x 75 x 75 composite Type 4X Black	A16075P	Composite	149 x 64 x 2
EXE1907555	Ex e 190 x 75 x 55 composite Type 4X Black	A19075P	Composite	179 x 64 x 2
EXE1907575	Ex e 190 x 75 x 75 composite Type 4X Black	A19075P	Composite	179 x 64 x 2
EXE12212090	Ex e 122 x 120 x 90 composite Type 4X Black	A122120P	Plated Steel	108 x 107 x 1.5
EXE22012090	Ex e 220 x 120 x 90 composite Type 4X Black	A220120P	Plated Steel	206 x 107 x 1.5
EXE16016090	Ex e 160 x 160 x 90 composite Type 4X Black	A160160P	Plated Steel	143 x 144 x 1.5
EXE26016090	Ex e 260 x 160 x 90 composite Type 4X Black	A260160P	Plated Steel	244 x 144 x 1.5
EXE36016090	Ex e 360 x 160 x 90 composite Type 4X Black	A360160P	Plated Steel	344 x 144 x 1.5
EXE56016090	Ex e 560 x 160 x 90 composite Type 4X Black	A560160P	Plated Steel	543 x 144 x 2.5
EXE255250120	Ex e 255 x 250 x 120 composite Type 4X Black	A255250P	Plated Steel	240 x 233 x 1.5
EXE400250120	Ex e 400 x 250 x 120 composite Type 4X Black	A400250P	Plated Steel	384 x 233 x 1.5
EXE400405120	Ex e 400 x 405 x 120 composite Type 4X Black	A400405P	Plated Steel	385 x 390 x 1.5
EXE400405165	Ex e 400 x 405 x 165 composite Type 4X Black	A400405P	Plated Steel	385 x 390 x 1.5

Zonex enclosures are not intended for use in explosion-proof or flame-proof (Ex d) applications
 *Purchase panels separately

HOFFMAN Zonex

STAINLESS STEEL SCREW-COVER ENCLOSURES



FEATURES

- Superior corrosion resistance with all Type 316 construction including self-retained cover screws
- Easy installation with welded heavy gauge mounting feet and interior weld nut for panel and or DIN rail mounting
- Secure sealing with standard one-piece polyurethane or high-temperature silicon gasket
- Screw cover features self-captivated screws

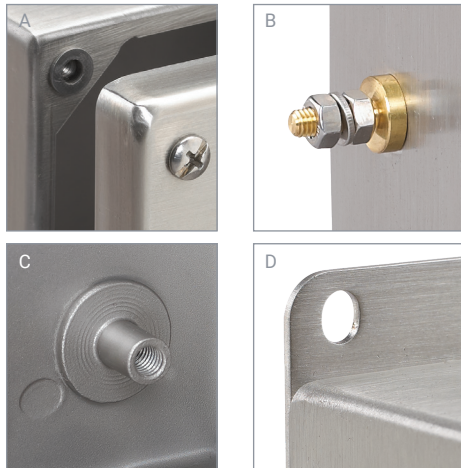

- A) Easy-to-remove Type 316 stainless steel cover with capivated screws for corrosion resistance
- B) 6 mm internal/external brass bonding provision
- C) Internal weld nuts for panel or DIN rail installation
- D) Welded-on, full-width top and bottom wall-mount brackets for easy installation

SPECIFICATIONS

- Type 316 stainless steel
- 6 mm internal and external bonding provision
- Wide temperature range
 - Standard polyurethane gasket (-40 C to +70 C, -40 F to 158 F)
 - Optional silicon gasket (-55 C to +180 C, -67 F to 356 F)

CERTIFICATIONS

- Zone 1 or 2 classified areas
- IECEx, ATEX, and AEx approvals
 - Ex e IIC Gb
 - Ex tb IIIC Db IP 66
- cUL Type 4, 4X, & 12
- IEC IP66 Rated



SCREW-COVER ATEX (Standard Sizes)

Catalog Number	Description (in.)	Optional Panel*	Panel Size (in.)
EXE443SS61	ATEX 4 x 4 x 3, SS316, Type 4X	A4P4G	2.88 x 2.88
EXE664SS61	ATEX 6 x 6 x 4, SS316, Type 4X	A6P6G	4.88 x 4.88
EXE774SS61	ATEX 7 x 7 x 4, SS316, Type 4X	A7P7G	5.88 x 5.88
EXE965SS61	ATEX 8.50 x 5.75 x 5, SS316, Type 4X	A9P9G	7.38 x 4.63
EXE10105SS61	ATEX 10 x 10 x 5, SS316, Type 4X	A10P10G	8.88 x 8.88

Zonex enclosures are not intended for use in explosion-proof or flame-proof (Ex d) applications
 *Purchase panels separately

HOFFMAN Zonex

STAINLESS STEEL INCH-HINGE ENCLOSURES

FEATURES

- Easy installation with welded heavy gauge mounting feet and easy-to-remove gland plates
- Superior corrosion resistance with Type 316 stainless steel construction
- Easy accessibility with ¼-turn slotted latch and 210 degree wide opening door that is easily removed by pulling clip style hinge pins
- Secure sealing with standard polyurethane or high-temperature silicon gasket to protect against water and dust ingress
- Gland plates made of 126A (3 mm) Type 316 stainless steel



SPECIFICATIONS

- Type 316 stainless steel
- 10 mm internal and external bonding provision
- Up to 4 gland plates
- Wide temperature range:
 - Polyurethane Gasket (-40 C to +70 C, -40 F to 158 F)
 - Silicon Gasket (-55 C to +180 C, -67 F to 356 F)

CERTIFICATIONS

- Certified for Zone 1 or 2 areas
- ATEX and IECEx approvals
 - Ex e IIC Gb
 - Ex tb IIIC Db IP 66
- cUL Type 4, 4X, & 12
- IEC IP66 Rated



- Heavy-duty 3-mm (12 gauge) welded-on brackets on top and bottom for easy site installation
- Internal studs for panel or DIN rail mounting
- 210-degree opening door that is easily removed by pulling clip style hinge pins
- Fabricated and formed entries for gland plate screws provide quick and easy installation
- Type 316 stainless steel slotted ¼ -turn insert for easy access and closure

INCH-HINGE COVER

Catalog Number	Description (in.)	Optional Panel*
EXE12126SS61	ATEX 12 x 12 x 6, SS316, Type 4X	CP1212G
EXE12128SS61	ATEX 12 x 12 x 8, SS316, Type 4X	CP1212G
EXE16126SS61	ATEX 16 x 12 x 6, SS316, Type 4X	CP1612G
EXE16128SS61	ATEX 16 x 12 x 8, SS316, Type 4X	CP1612G
EXE16166SS61	ATEX 16 x 16 x 6, SS316, Type 4X	CP1616G
EXE16168SS61	ATEX 16 x 16 x 8, SS316, Type 4X	CP1616G
EXE20166SS61	ATEX 20 x 16 x 6, SS316, Type 4X	CP2016G
EXE20168SS61	ATEX 20 x 16 x 8, SS316, Type 4X	CP2016G
EXE20208SS61	ATEX 20 x 20 x 8, SS316, Type 4X	CP2020G
EXE24208SS61	ATEX 24 x 20 x 8, SS316, Type 4X	CP2420G
EXE24248SS61	ATEX 24 x 24 x 8, SS316, Type 4X	CP2424G
EXE242412SS61	ATEX 24 x 24 x 12, SS316, Type 4X	CP2424G
EXE30208SS61	ATEX 30 x 20 x 8, SS316, Type 4X	CP3020G
EXE30248SS61	ATEX 30 x 24 x 8, SS316, Type 4X	CP3024G
EXE303012SS61	ATEX 30 x 30 x 12, SS316, Type 4X	CP3030G
EXE36248SS61	ATEX 36 x 24 x 8, SS316, Type 4X	CP3624G

Zonex enclosures are not intended for use in explosion-proof or flame-proof (Ex d) applications
*Purchase panels separately

STANDARD GLAND PLATES

Catalog Number	Description (in.)	Ground	Cutout Size (in.)	W x H (in.)
GPS126SS6	12 x 6 side	Yes	7.50 x 3.75	8.98 x 5.23
GPS128SS6	12 x 8 side	Yes	7.50 x 5.75	8.98 x 7.23
GP126SS6	12 x 6 surface	No	9.50 x 3.75	10.98 x 5.23
GP128SS6	12 x 8 surface	No	9.50 x 5.75	10.98 x 7.23
GP166SS6	16 x 6 surface	No	13.50 x 3.75	14.98 x 5.23
GP168SS6	16 x 8 surface	No	13.50 x 5.75	14.98 x 7.23
GP206SS6	20 x 6 surface	No	17.50 x 3.75	18.98 x 5.23
GP208SS6	20 x 8 surface	No	17.50 x 5.75	18.98 x 5.23
GP248SS6	24 x 8 surface	No	21.50 x 5.75	22.98 x 7.23
GP2412SS6	24 x 12 surface	No	21.50 x 7.00	22.98 x 8.48

GP2412SS6 is also used on 30 x 12 standard enclosure bottom

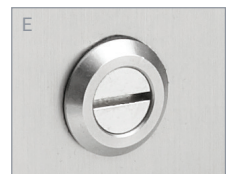
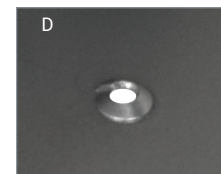

HOFFMAN Zonex

STAINLESS STEEL METRIC-HINGE ENCLOSURES

FEATURES

- Superior corrosion resistance with all Type 316 stainless steel construction
- Easy installation with welded horizontal mounting brackets and sealed well nuts for gland plates
- Silicon gasket for secure sealing against water and dust ingress in high-temperature applications
- Easy accessibility with ¼-turn latch featuring 3 mm double-bit insert for security

SPECIFICATIONS

- Type 316 stainless steel construction and external fasteners
- Internal/external brass earth/ground provision
- Up to 4 removable gland plates standard
- Silicon high-temperature gasket on doors and gland plates
 - Temperature range -55 C to +180 C (-67 F to 356 F)

CERTIFICATIONS

- Certified for Zone 1 or 2 areas
- ATEX, IECEx, and AEx approvals
 - Ex e IIC Gb
 - Ex tb IIIC Db IP 66
- cUL Type 4, 4X, & 12
- IEC IP66 Rated

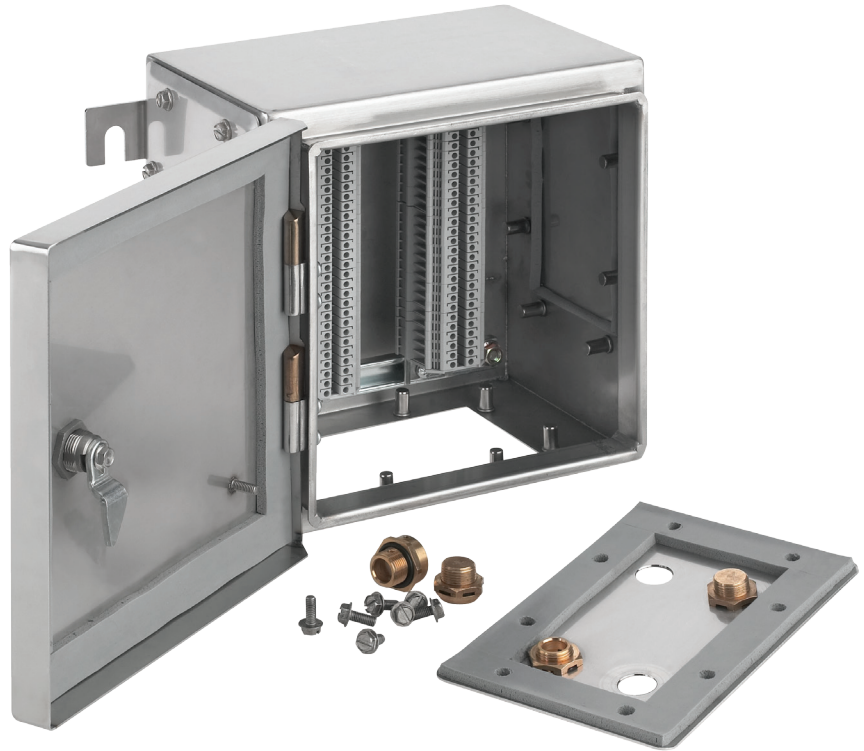

METRIC-HINGE COVER

Catalog Number (1 Gland Plate)	Catalog Number (3 Gland Plates)	Description (mm)	White Panel*	Conductive Panel*	Panel Size (mm)
ATEX262616SS61	ATEX262616SS63	260 x 260 x 160, SS316, Type 4X	ATEX26P26	ATEX26P26G	214 x 214
ATEX262620SS61	ATEX262620SS63	260 x 260 x 205, SS316, Type 4X	ATEX26P26	ATEX26P26G	214 x 214
ATEX303016SS61	ATEX303016SS63	306 x 306 x 160, SS316, Type 4X	ATEX30P30	ATEX30P30G	260 x 260
ATEX303020SS61	ATEX303020SS63	306 x 306 x 205, SS316, Type 4X	ATEX30P30	ATEX30P30G	260 x 260
ATEX382616SS61	ATEX382616SS63	380 x 260 x 160, SS316, Type 4X	ATEX38P26	ATEX38P26G	334 x 214
ATEX382620SS61	ATEX382620SS63	380 x 260 x 205, SS316, Type 4X	ATEX38P26	ATEX38P26G	334 x 214
ATEX453816SS61	ATEX453816SS63	458 x 382 x 160, SS316, Type 4X	ATEX45P38	ATEX45P38G	412 x 336
ATEX484820SS61	ATEX484820SS63	480 x 480 x 205, SS316, Type 4X	ATEX48P48	ATEX48P48G	434 x 434
ATEX503516SS61	ATEX503516SS63	500 x 350 x 160, SS316, Type 4X	ATEX50P35	ATEX50P35G	454 x 304
ATEX503520SS61	ATEX503520SS63	500 x 350 x 205, SS316, Type 4X	ATEX50P35	ATEX50P35G	454 x 304
ATEX624520SS61	ATEX624520SS63	620 x 450 x 205, SS316, Type 4X	ATEX62P45	ATEX62P45G	574 x 404
ATEX745520SS61	ATEX745520SS63	740 x 550 x 205, SS316, Type 4X	ATEX74P55	ATEX74P55G	694 x 504
ATEX765020SS61	ATEX765020SS63	762 x 508 x 205, SS316, Type 4X	ATEX76P50	ATEX76P50G	716 x 462

Zonex enclosures are not intended for use in explosion-proof or flame-proof (Ex d) applications
*Purchase panels separately

- A) Heavy-duty welded horizontal mounting brackets for single-person installation
- B) Sealed well nut provides easy and secure fastener attachment for gland plates
- C) 180-degree opening door easily removed by lift-off hinge
- D) Type 316 stainless steel ¼-turn door latch with 3 mm double-bit insert

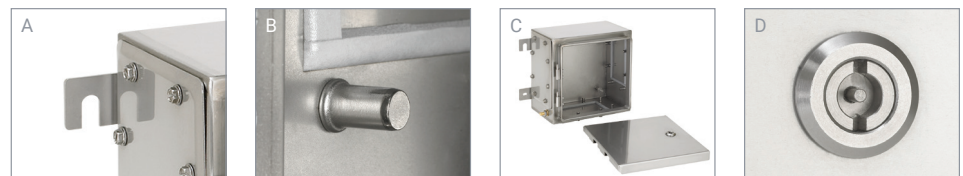

Thermal Management



HAZARDOUS LOCATION HEATER

Designed for use where electronic components require protection from condensation and corrosion, sudden temperature drops, and low temperatures.

FEATURES AND BENEFITS

- 100 Watts of heat with a large convection surface
- Compact design easily mounts with DIN rail
- Maintenance-free extruded aluminum heat sink
- Surface temperature T4, 275 F (135 C)
- Operating voltage of 110 – 120 VAC

CERTIFICATIONS

- Zone 1 or 2 classified areas
- ATEX and IECEx approved
 - Ex d IIC T5 or T4 Gb
 - Ex tb IIIC T100 C or T135 C Db IP6X
 - 40 C < Tamb < +40 C
- IEC 60529, IP65/1 (grounded)



Catalog Number	Description
HLHEAT100	Heater ATEX / IECEx 100 Watt 120 VAC



HAZARDOUS LOCATION THERMOSTAT

Ideal for temperature control of heaters or low-temperature alarms in enclosures used in hazardous areas.

FEATURES AND BENEFITS

- Long service life of greater than 100,000 cycles
- Robust thermostatic bimetallic sensor element
- Direct connect and switch without additional relays
- Compact design with high switching capacity
- Maximum operating voltage 250 VAC and 100 VDC
- One-pole contact opens with rising temperature
- Mounting bracket and DIN clip for mounting

CERTIFICATIONS

- Zone 1 or 2 classified areas
- ATEX and IECEx approved
 - Ex d IIC T6 Gb
 - Ex tb IIIC T85 C Db
 - 40 C < Tamb < +60 C
- IEC 60529, IP65/1 (grounded)



Catalog Number	Description
HLTHERMNC	Thermostat ATEX / IECEx 59 Degree NC

HOFFMAN VORTEX A/C HAZARDOUS LOCATION ENCLOSURE COOLERS

With almost no moving parts, these enclosure coolers are a highly reliable and virtually maintenance-free cooling solution. Coolers use compressed air to keep electrical and electronic enclosures cool, clean, and protected.



Catalog Number	Description
VHL09160	HazLoc Vortex AC 900 BTU
VHL15160	HazLoc Vortex AC 1500 BTU
VHL25160	HazLoc Vortex AC 2500 BTU
VHL50160	HazLoc Vortex AC 5000 BTU

FEATURES AND BENEFITS

- Reduced energy use through integral mechanical thermostat enhances performance efficiency
- Operates in environments up to 175 F (80 C)
- Flexible installation with top, side or front mount options and easily mounts in restricted space
- Multiple cooling capacities available from 900 BTUs/Hr (264 watts) to 5,000 BTUs/Hr (1,465 Watts)
- Quieter operation with a noise reduction of 78 percent when compared to traditional tube Vortex coolers
- Supplied with five-micron, automatic drain compressed air filter, cold ducting kit, cold air muffler, and check valve

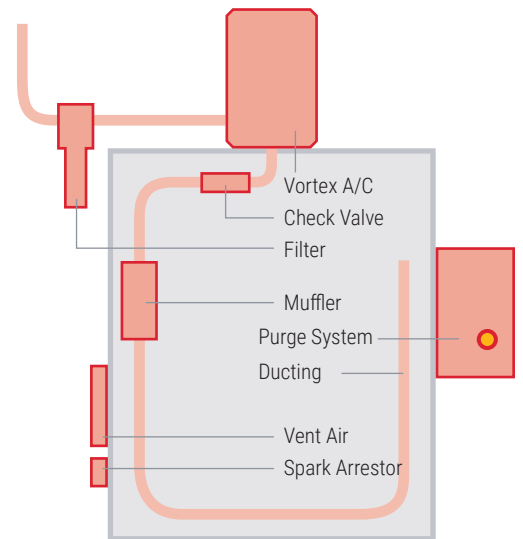

CERTIFICATIONS

- UL Classified
 - Class 1, Division 2, Groups A through D
 - Class II, Division 2, Groups F and G
 - Class III locations
- Maintains enclosure Type 4, 4X rating when properly installed and when used with an approved purge/pressurization system



Accessories



HAZARDOUS LOCATION BREATHER DRAINS

Prevent moisture build-up within enclosures in hazardous environments.

FEATURES AND BENEFITS

- Reduce corrosion that can limit the life of internal electrical and electronic components
- Prevent condensation when installations are subject to fluctuations in temperature in hazardous locations
- Available for Increased Safety (Ex e) and Flameproof (Ex d) applications

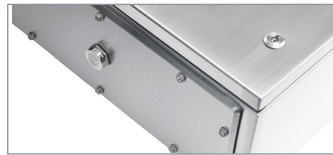
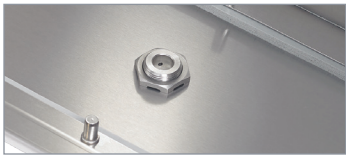

Certifications

- Zone 1 or 2 classified areas
- ATEX and IECEx approved
 - Ex e IIC Gb
 - Ex d IIC
 - Ex tb IIIC Db IP66
- cCSAus Certified Class 1 Zone 1, Ex e II, IP66, Type 4X
- NEMA/EEMAC Type 4, 4X
- IEC 60529, IP66
- Maintains enclosure Type 4, 4X rating when properly installed



Catalog Number	Description
EXEBDM20SS6	Exe M20 316SS Breather Drain
EXEBDM25SS6	Exe M25 316SS Breather Drain
EXDBDM20SS6	Exd M20 316SS Breather Drain
EXDBDM25SS6	Exd M25 316SS Breather Drain



HAZARDOUS LOCATION HOLE SEALS

Seal extra pushbutton holes, conduit openings and knockout openings against dust, dirt, oil, and water.

FEATURES AND BENEFITS

- Superior corrosion resistance with Type 316 stainless steel construction
- Secure sealing with silicon gasket to protect against water and dust ingress in high temperature applications
- Wide applicability with hole sizes up to 4 in. (100 mm) in diameter and enclosure wall thickness up to 0.31 in. (8 mm)

CERTIFICATIONS

- Zone 1 or 2 classified areas
- IECEx and ATEX approvals
 - Ex e IIC Gb
 - Ex tb IIIC Db IP 66
- UL 508A Component Recognized; Type 3R, 4, 4X, 12, 13
- CSA Type 3R, 4, 4X, 12, 13
- NEMA/EEMAC Type 3R, 4, 4X, 12, 13
- IEC 60529, IP66



Catalog Number	Description
EXS056MSS6	Ex SS Hole Seal for 0.56 in. Micro
EXSPBSS6	Ex SS Hole Seal for 22.5 mm
EXS050SS6	Ex SS Hole Seal for 0.50 in.
EXS075SS6	Ex SS Hole Seal for 0.75 in.
EXSPBGSS6	Ex SS Hole Seal for 30.5 mm
EXS100SS6	Ex SS Hole Seal for 1.00 in.
EXS125SS6	Ex SS Hole Seal for 1.25 in.
EXS150SS6	Ex SS Hole Seal for 1.50 in.
EXS200SS6	Ex SS Hole Seal for 2.00 in.
EXS250SS6	Ex SS Hole Seal for 2.50 in.
EXS300SS6	Ex SS Hole Seal for 3.00 in.
EXS350SS6	Ex SS Hole Seal for 3.50 in.
EXS400SS6	Ex SS Hole Seal for 4.00 in.



HAZARDOUS LOCATION WINDOW KITS

Designed for increased safety enclosures in hazardous areas as a viewing window where visibility of internal components is desired.

FEATURES AND BENEFITS

- Robust window frames are made from heavy-gauge Type 316 stainless steel with a brushed finish
- Secure sealing with silicon gasket to protect against water and dust ingress in high temperature applications
- Maintain visual on components through .25-in. (6 mm) tempered safety glass
- Easy installation in enclosure cutouts with window frame hardware



CERTIFICATIONS

- Zone 1 or 2 classified areas
- IECEx and ATEX Approvals
 - Ex e IIC Gb
 - Ex tb IIIC Db IP 66
- UL 508A Component Recognized; Type 3R, 4, 4X, 12
- CSA Type 3R, 4, 4X, 12
- NEMA/EEMAC 3R, 4, 4X, 12
- IEC 60529, IP66



Catalog Number	Description (in.)
EXWK53SS6	Ex SS Window Kit 5 x 3
EXWK95SS6	Ex SS Window Kit 9 x 5.5
EXWK711SS6	Ex SS Window Kit 7 x 11
EXWK138SS6	Ex SS Window Kit 13 x 8
EXWK715SS6	Ex SS Window Kit 7 x 15
EXWK1711SS6	Ex SS Window Kit 17 x 11
EXWK720SS6	Ex SS Window Kit 7 x 20
EXWK2315SS6	Ex SS Window Kit 23 x 15
EXWK724SS6	Ex SS Window Kit 7 x 24
EXWK729SS6	Ex SS Window Kit 7 x 29
EXWK2919SS6	Ex SS Window Kit 29 x 19

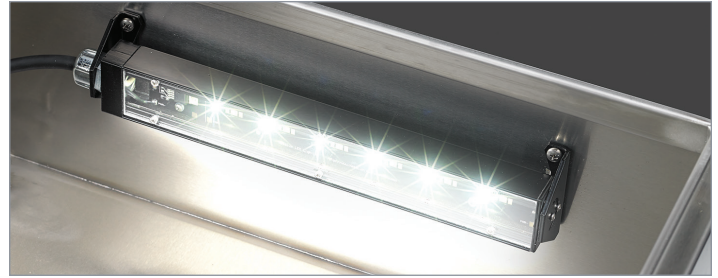

HAZARDOUS LOCATION LED LIGHTS

Provide enclosure illumination in hazardous environments.

FEATURES AND BENEFITS

- Maximum lighting for control panels with 454 to 1,756 lumens
- Minimum power consumption and superior lighting with 24 VDC input
- LED technology provides high longevity with up to 100,000 operating hours
- Easy installation with mechanical assembly kit while maintaining UL listing
- Available in 12, 24, 36, and 48 inches in length
- Operating temperature of -40 F (-40 C) to 185 F (80 C)
- CAN LED light is designed with a robust construction suitable for outdoor applications



CERTIFICATIONS

- Class I Division 2, Groups A, B, C and D, T3
- Conforms To CSA.22.2 No. 137, 213, 250 Standards
- Conforms To UL 844 & 1598 Standards
- Maintains enclosure Type 4, 4X rating when properly installed



Catalog Number	Description
LEDHL24V12	12 in. 24V C1D2 LED Light
LEDHL24V24	24 in. 24V C1D2 LED Light
LEDHL24V36	36 in. 24V C1D2 LED Light
LEDHL24V48	48 in. 24V C1D2 LED Light
LEDHL24VCAN	CAN 24V C1D2 LED Light
LEDHLSWITCH	Door Switch C1D2
AHKC1D2LED	Hardware kit

Purge & Pressurization



FEATURES AND BENEFITS

- Provides purging and pressurization of sealed enclosures for use in hazardous locations
- Provides a low total cost of ownership for enclosures placed in hazardous locations
- Meets National and International certifications and specifications
- Purge units are dual rated Type Y and Z to cover many applications
- Type X has an electrical shut-off to turn off power if pressurization is lost



CERTIFICATIONS - LISTED, RATED AND CLASSIFIED

- ATEX
- IEC / EN 60079-2
- cUL Classified
- NEC Type Y & Z or NEC Type X
- NFPA 496

CF – CONTINUOUS FLOW

The enclosure is maintained with a positive pressure by limiting the exiting airflow through a fixed opening. They are economical and commonly used on smaller enclosures.

LC – LEAK COMPENSATION

The enclosure interior pressure is maintained with pressure or leak compensation components. Once pressurized, these devices compensate for leakages that may occur through the cabinet. These devices use less compressed air, offer lower operating cost, and are ideal for larger enclosures.

TYPE Z

- Class 1 Division 2 / Zone 2
 - Allows use of general purpose equipment
 - Provides local alarm / indicator and remote alarm signal if pressurization is lost

TYPE Y

- Class 1 Division 1 / Zone 1
 - Allows use of Class 1 Division 2 or Zone 2 equipment
 - Provides local alarm / indicator and remote alarm signal if pressurization is lost

TYPE X

- Class 1, Division 1 / Zone 1 or Group 1
 - Allows use of general purpose equipment
 - Provides local alarm / indicator, remote alarm signal and shuts off electrical power to the enclosures if pressurization is lost

Catalog Number	Description
PLCF1YZ	Purge and Pressurization, Leak Comp, Flush Mount, Type Y and Z, IS output
PLCB1YZ	Purge and Pressurization, Leak Comp, Bracket Mount, Type Y and Z, IS output
PCFF1YZ	Purge and Pressurization, Continuous Flow, Flush Mount, Type Y and Z, IS output
PCFB1YZ	Purge and Pressurization, Continuous Flow, Bracket Mount, Type Y and Z, IS output
PLCB1X	Purge and Pressurization, Leak Comp, Bracket Mount, Type X, PO output
PSKIT	Purge and Pressurization, Common Parts All models, Service Kit



North America

Minneapolis, MN	Tel: +1.763.421.2240
Mexico City, Mexico	Tel: +52.55.5280.1449
Toronto, Canada	Tel: +1.416.289.2770

South America

Sao Paulo, Brazil	Tel: +55.11.5184.2100
Boitura, Brazil	Tel: +55.15.3363.9148

Europe

Betschdorf, France	Tel: +33.3.88.90.64.90
Straubenhardt, Germany	Tel: +49.7082.794.0
Dzierzoniow, Poland	Tel: +48.74.64.63.900
Lainate, Italy	Tel: +39.02.932.7141

Middle East & India

Dubai, United Arab Emirates	Tel: +971.4.378.1700
Bangalore, India	Tel: +91.80.6715.2001

Asia

Shanghai, P.R. China	Tel: +86.21.2412.6943
Singapore	Tel: +65.6768.5800
Shin-Yokohama, Japan	Tel: +81.45.476.0271
Seoul, Korea	Tel: +82.2.2129.7755
Qingdao	Tel: +86.532.8771.6101

FOR MORE INFORMATION AND TO CONTACT US, GO TO NVENT.COM/HOFFMAN

Our powerful portfolio of brands:

CADDY ERICO HOFFMAN RAYCHEM SCHROFF TRACER



nVent.com/HOFFMAN